



US00D474756S

(12) **United States Design Patent**
Lee et al.

(10) **Patent No.:** **US D474,756 S**

(45) **Date of Patent:** **** May 20, 2003**

(54) **HANDSET**

(75) Inventors: **Kelley Ann Lee**, Pasadena, CA (US);
Andrew Julian Gartrell, Woodland Hills, CA (US)

(73) Assignee: **Nokia Corporation**, Espoo (FI)

(**) Term: **14 Years**

(21) Appl. No.: **29/156,737**

(22) Filed: **Mar. 5, 2002**

(51) **LOC (7) Cl.** **14-03**

(52) **U.S. Cl.** **D14/138**

(58) **Field of Search** D14/137, 138,
D14/218, 147-148, 247-248, 144, 341-347;
379/433.01-433.13, 419, 434, 428.01-428.04,
420.01-420.04, 440; 455/550-575, 90;
D21/517

(56) **References Cited**

U.S. PATENT DOCUMENTS

D353,809 S	*	12/1994	Nuovo et al.	D14/138
D388,784 S	*	1/1998	Phillips et al.	D14/138
D392,967 S	*	3/1998	Mason	D14/138
D396,230 S	*	7/1998	Phillips et al.	D14/138
D402,982 S	*	12/1998	Nagano et al.	D14/138
5,848,152 A	*	12/1998	Slipy et al.	379/433
D408,813 S	*	4/1999	Prior	D14/138
D410,002 S	*	5/1999	Collins	D14/138
D412,704 S	*	8/1999	Vuolteenaho et al.	D14/138
D415,149 S	*	10/1999	Vuolteenaho et al.	D14/138
D415,489 S	*	10/1999	Ke	D14/138
D419,992 S	*	2/2000	Kolinen	D14/138
D421,004 S	*	2/2000	Curtis	D14/138
D421,435 S	*	3/2000	Haase et al.	D14/137
D422,585 S	*	4/2000	Ng et al.	D14/137
D425,057 S	*	5/2000	Finkbeiner	D14/138
D427,171 S	*	6/2000	Frye et al.	D14/138
D428,401 S	*	7/2000	Curtis	D14/138
D433,002 S	*	10/2000	Kolinen	D14/138

D434,016 S	*	11/2000	Hunt	D14/138
D434,741 S	*	12/2000	Park	D14/138
D436,938 S	*	1/2001	Won	D14/138
6,195,569 B1	*	2/2001	Frederiksen	455/566
D439,230 S	*	3/2001	Braxton et al.	D14/138
D440,951 S	*	4/2001	Kolinen	D14/138
D443,258 S	*	6/2001	Gartrell et al.	D14/138
D445,102 S	*	7/2001	Lai	D14/138
D446,200 S	*	8/2001	Ko	D14/138
D446,509 S	*	8/2001	Chiu	D14/138
D448,355 S	*	9/2001	Higashi et al.	D14/138
D450,671 S	*	11/2001	Langford et al.	D14/138
D453,150 S	*	1/2002	Murray	D14/138
D454,549 S	*	3/2002	Vuolteenaho et al.	D14/138
D454,850 S	*	3/2002	Salmi et al.	D14/138
D455,134 S	*	4/2002	Kolinen	D14/138
D455,412 S	*	4/2002	Vuolteenaho et al.	D14/138
D455,413 S	*	4/2002	Lee	D14/138
D456,375 S	*	4/2002	Vuolteenaho et al.	D14/138
D456,376 S	*	4/2002	Vuolteenaho et al.	D14/138
D459,324 S	*	6/2002	Ahlgren	D14/138
D461,174 S	*	8/2002	Ruohonen	D14/138
2002/0039890 A1	*	4/2002	Kim	455/90
2002/0086714 A1	*	7/2002	Wang	455/567

* cited by examiner

Primary Examiner—Jeffrey Asch

(74) *Attorney, Agent, or Firm*—Banner & Witcoff, Ltd.

(57)

CLAIM

We claim the ornamental design for a handset, as shown.

DESCRIPTION

FIG. 1 is a bottom plan view of a handset;
FIG. 2 is a right side view thereof;
FIG. 3 is a front view thereof;
FIG. 4 is a left side view thereof;
FIG. 5 is a top plan view thereof;
FIG. 6 is a perspective front view thereof;
FIG. 7 is a perspective rear view thereof; and,
FIG. 8 is a rear view thereof.

1 Claim, 3 Drawing Sheets

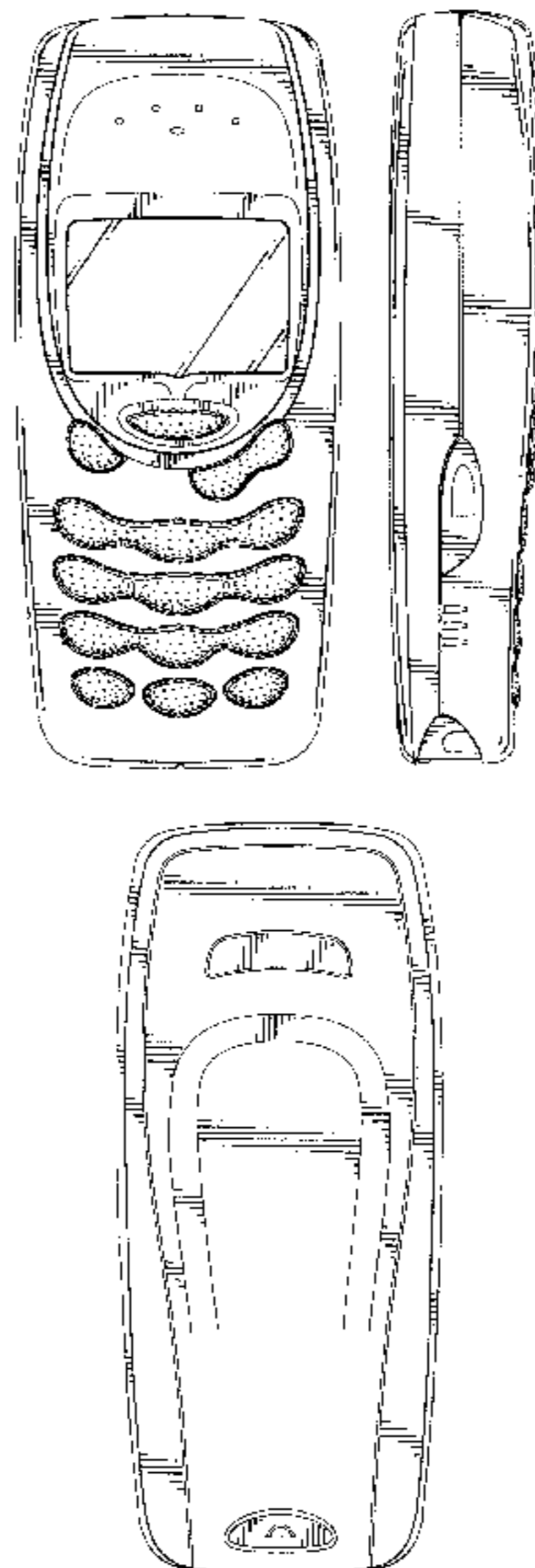

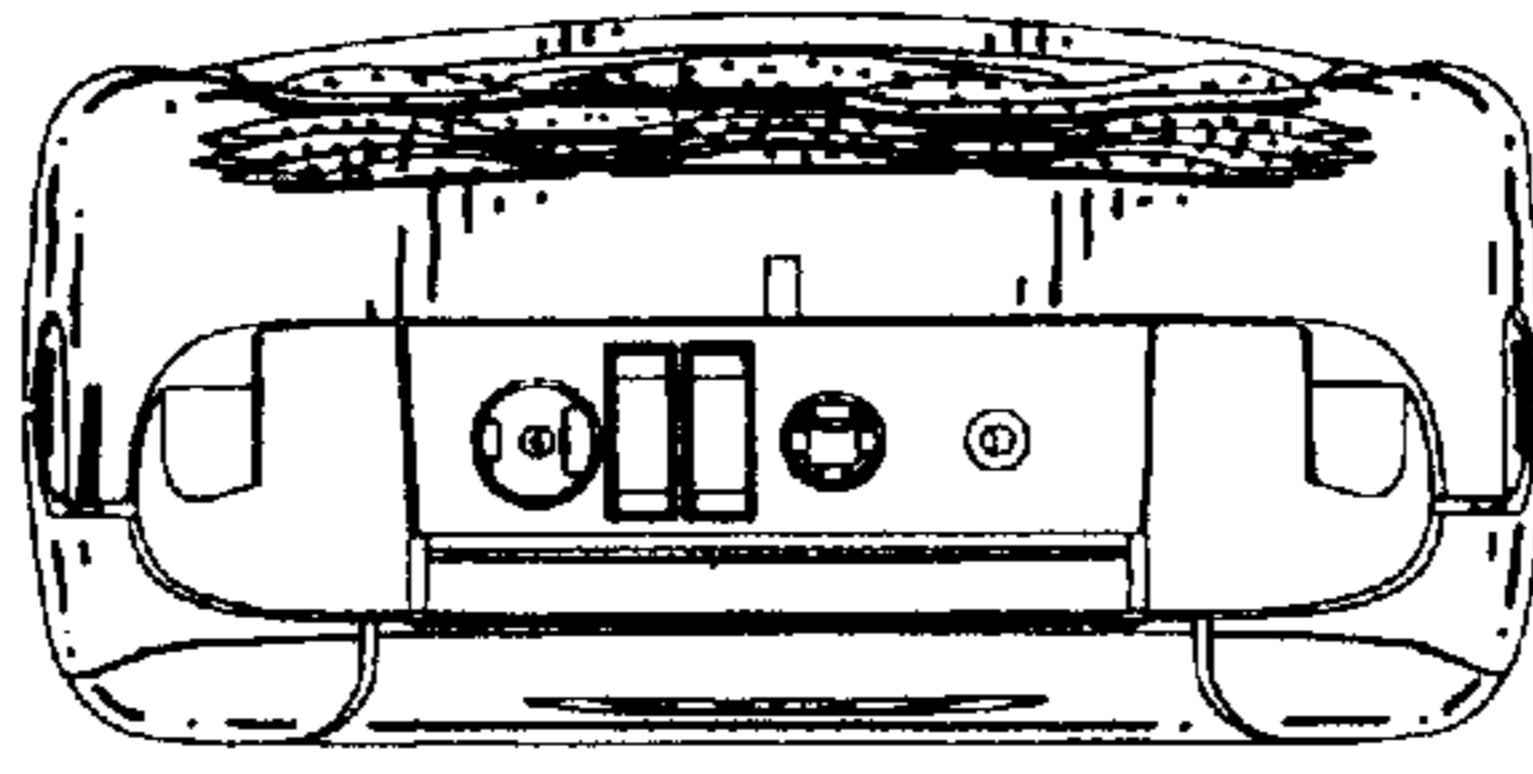

FIG. 1

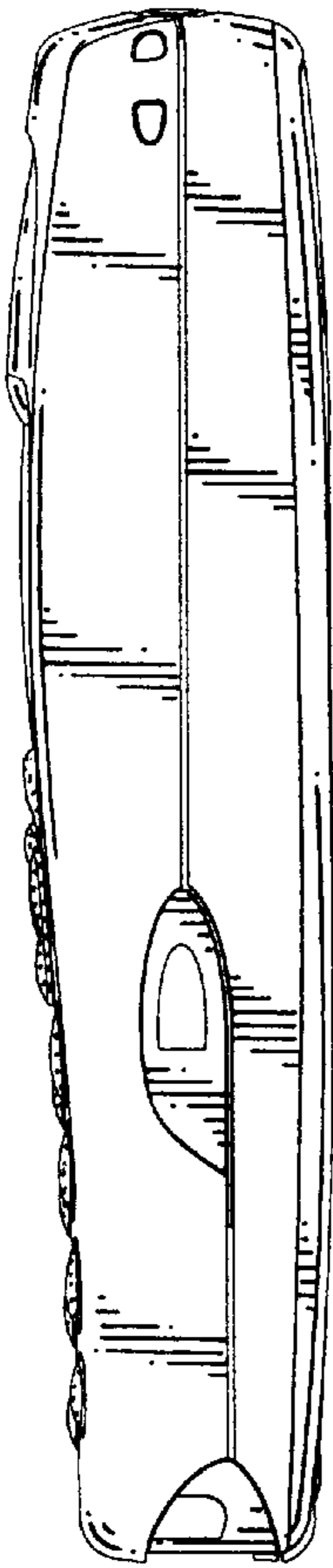

FIG. 2

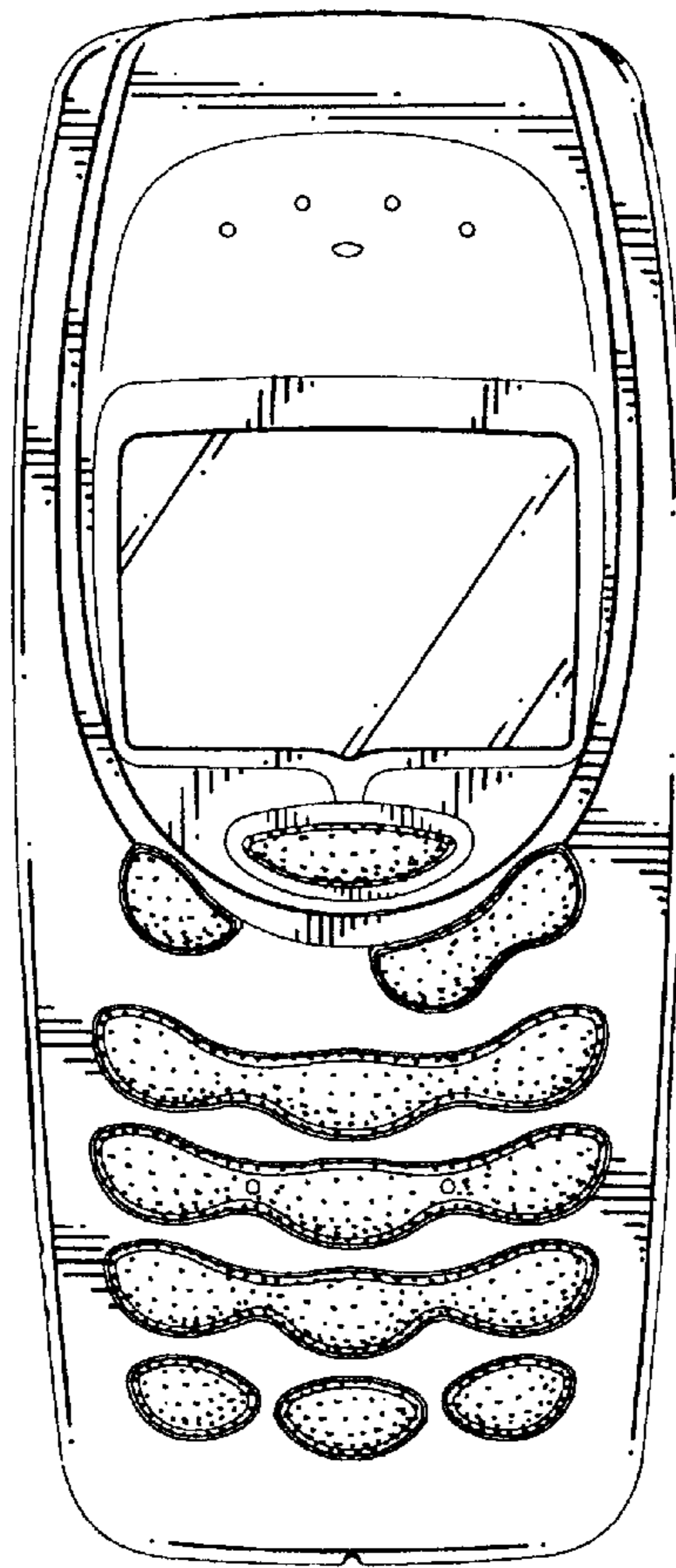

FIG. 3

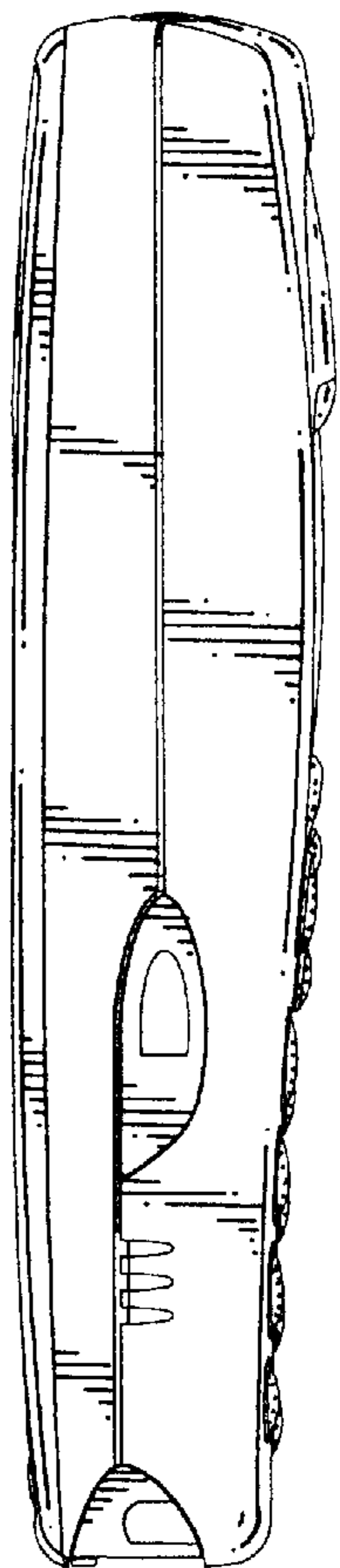

FIG. 4

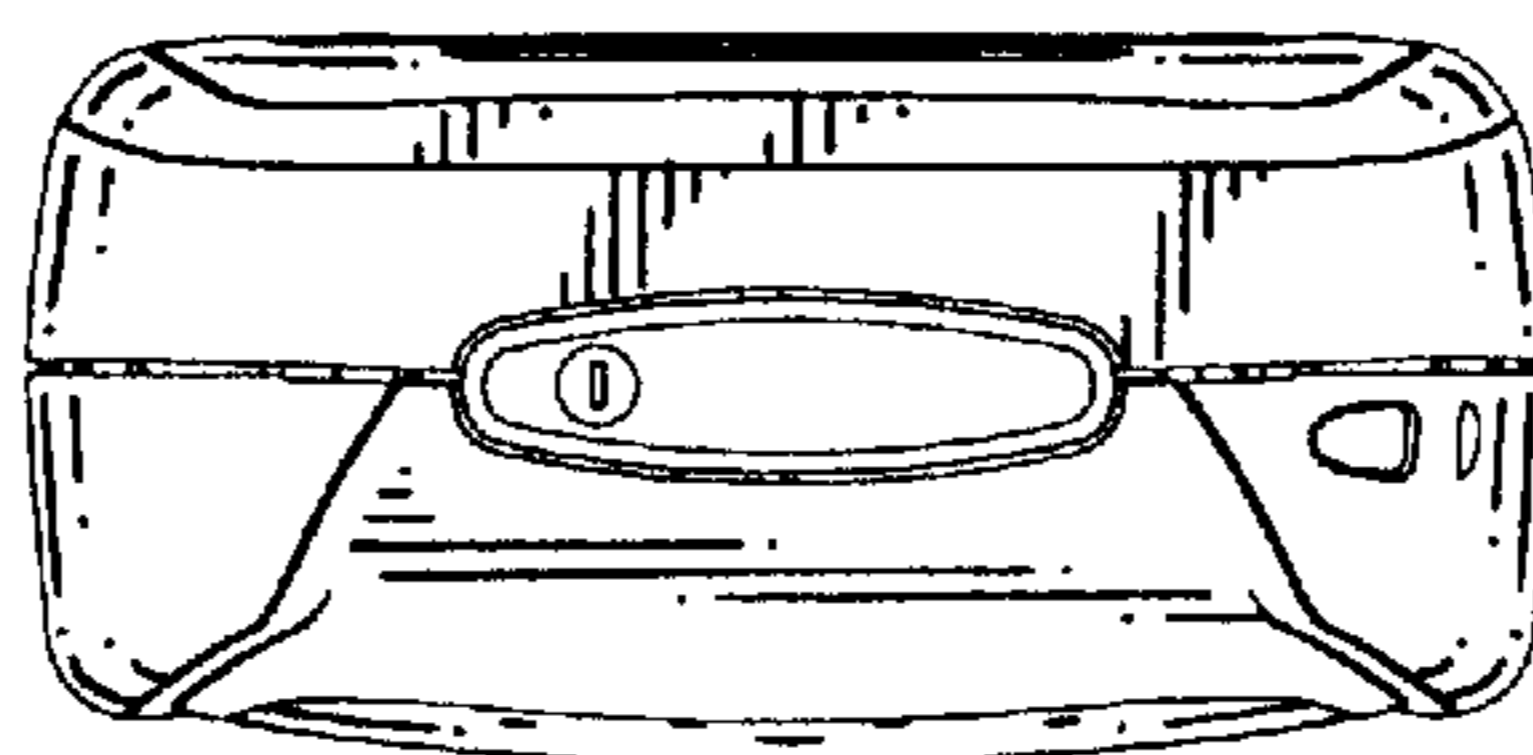

FIG. 5

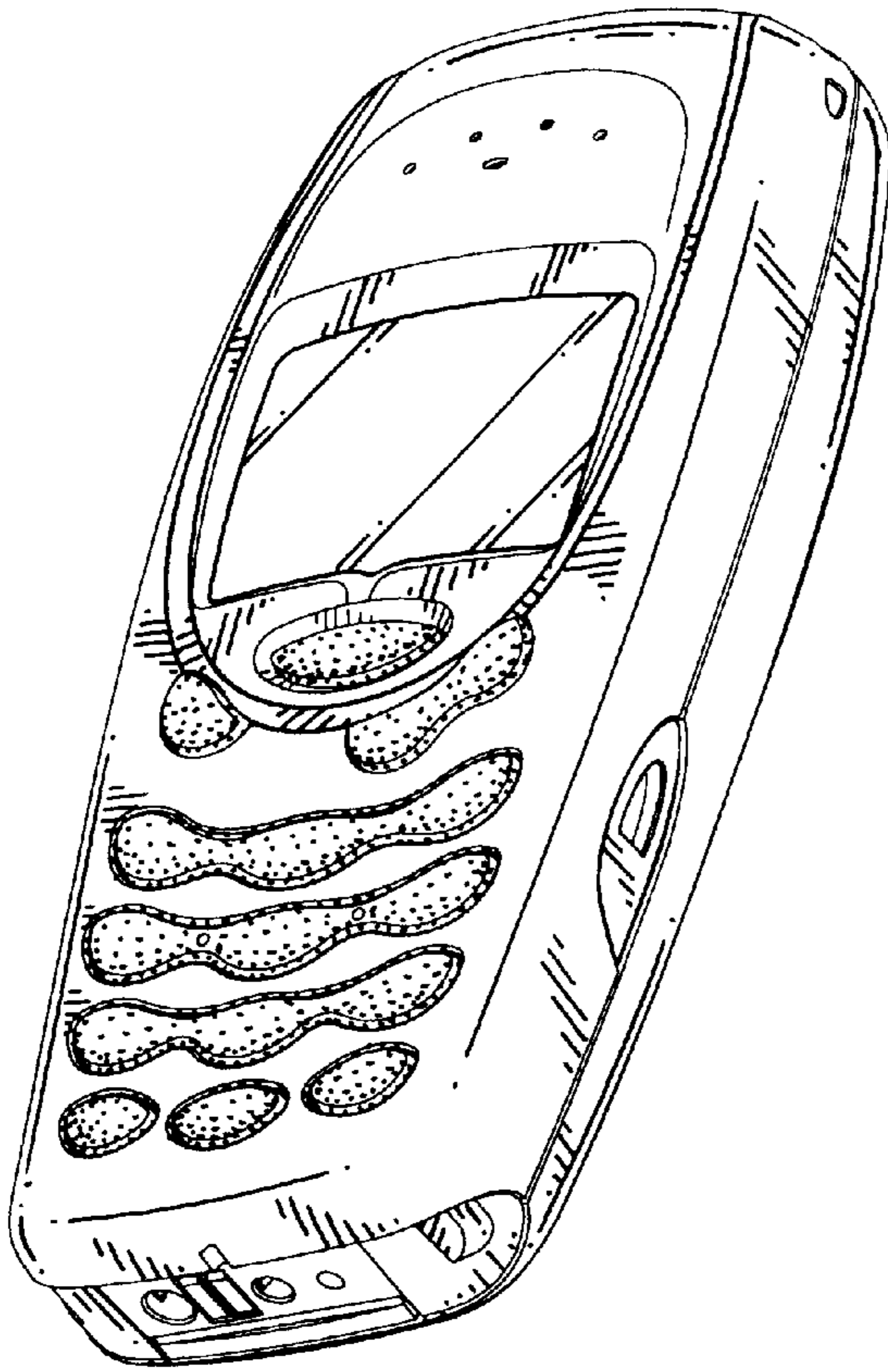

FIG. 6

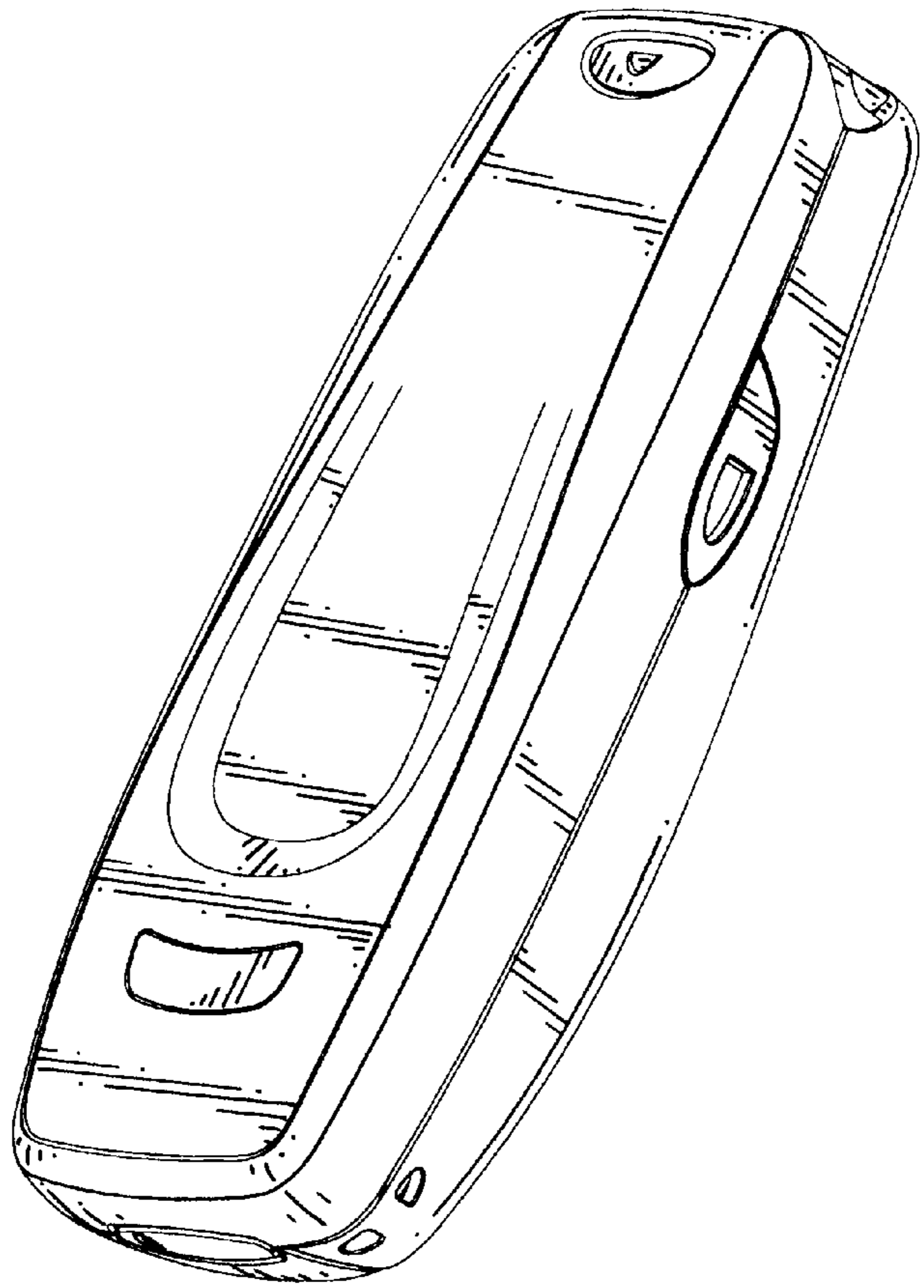

FIG. 7

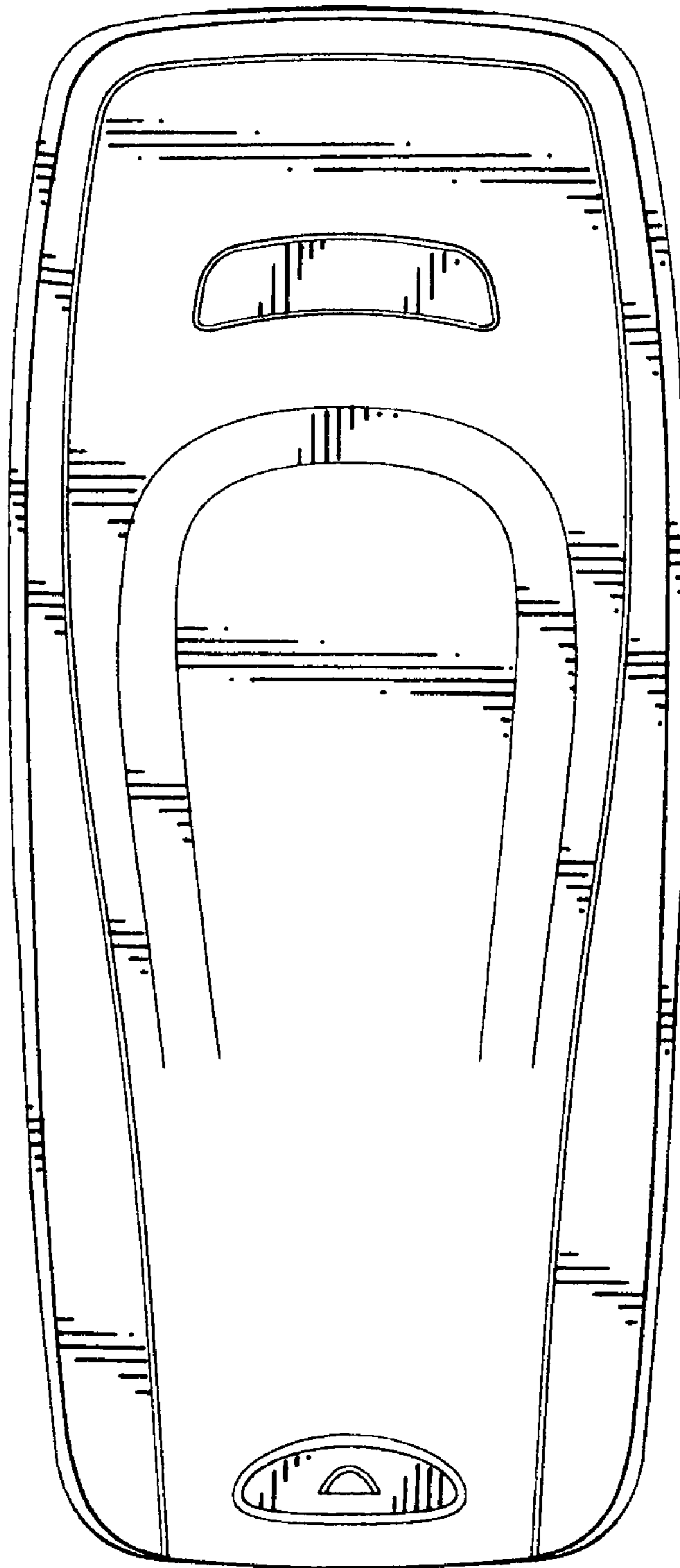

FIG.8