



US00D474718S

(12) **United States Design Patent**
Hartenstine et al.

(10) **Patent No.:** **US D474,718 S**

(45) **Date of Patent:** **** May 20, 2003**

(54) **STROLLER**

(75) Inventors: **Curtis M. Hartenstine**, Birdsboro, PA (US); **Matthew J. Ransil**, Stevens, PA (US)

(73) Assignee: **Graco Children's Products Inc.**, Exton, PA (US)

(**) Term: **14 Years**

(21) Appl. No.: **29/159,520**

(22) Filed: **Apr. 24, 2002**

(51) **LOC (7) Cl.** **12-12**

(52) **U.S. Cl.** **D12/129**

(58) **Field of Search** D12/128-133;
280/30, 33, 998, 47.36, 47.371, 642, 644,
647, 648, 649, 650

(56) **References Cited**

U.S. PATENT DOCUMENTS

- D452,461 S * 12/2001 Dumigan et al. D12/129
- D461,148 S * 8/2002 Hartenstine et al. D12/129

OTHER PUBLICATIONS

Sears Shopping Cart Stroller, Industrial Designers Society of America, 1 pp. (2001), see <http://www.idsa.org/whatis/see-what/idea2001/winners/B9072.htm>.

Kroozer Zooper Stroller, 1 pp. (available pre-Apr. 2002), see <http://www.zooperstrollers.com/products/kroozer/default.htm>.

Buddy Zooper Stroller, 1 pp. (available pre-Apr. 2002), see <http://www.zooperstrollers.com/products/buddy/default.htm>.

Mutsy Strollers—Urbanrider, FreeRider, 3Rider, HiRider, Cipressa, and Twister, 6 pps. (available pre-Apr. 2002), see http://www.musty.nl/ef/fts/FRAMESET_KW.htm.

* cited by examiner

Primary Examiner—Marcus A. Jackson

(74) *Attorney, Agent, or Firm*—Foley & Lardner

(57) **CLAIM**

The ornamental design for a stroller, as shown and described.

DESCRIPTION

FIG. 1 is a front perspective view of our new design, with the broken line showing for illustrative purposes only and forming no part of the claimed design; FIG. 2 is a rear perspective view thereof; FIG. 3 is a front elevation view thereof; FIG. 4 is a rear elevation view thereof; FIG. 5 is a left side elevation view thereof; FIG. 6 is a right side elevation view thereof; FIG. 7 is a top plan view thereof; and, FIG. 8 is a bottom plan view thereof.

1 Claim, 8 Drawing Sheets

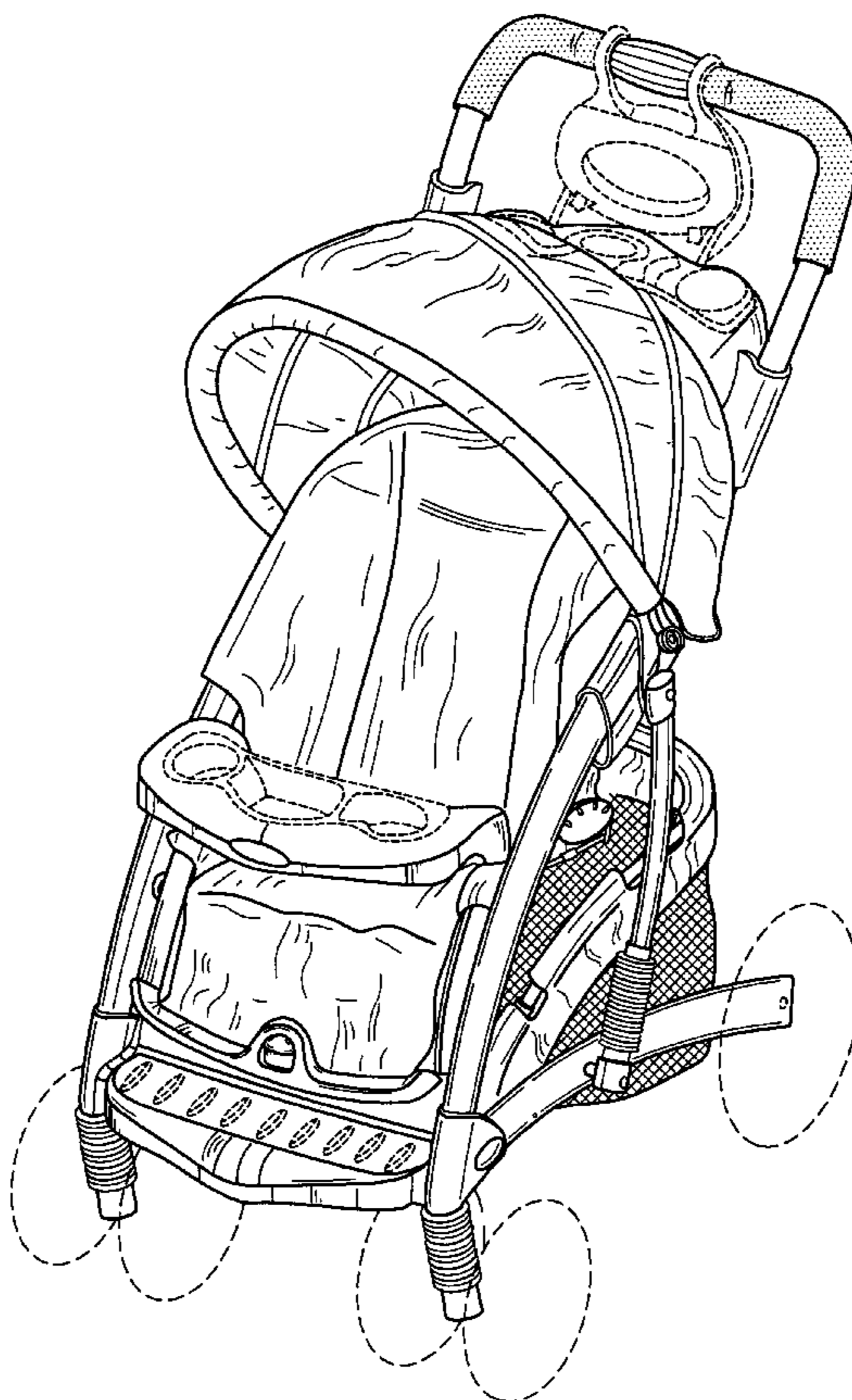

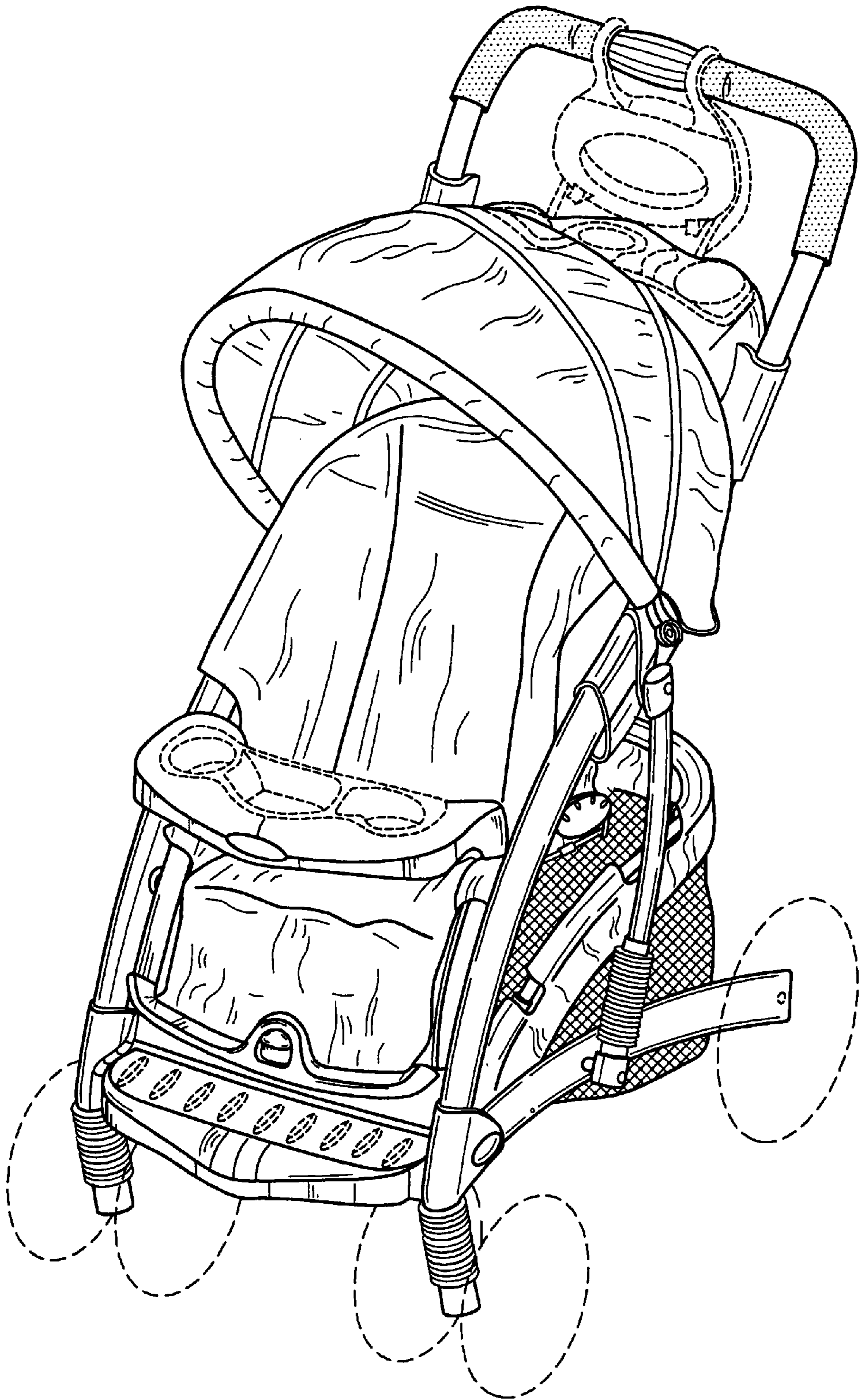

FIG. 1

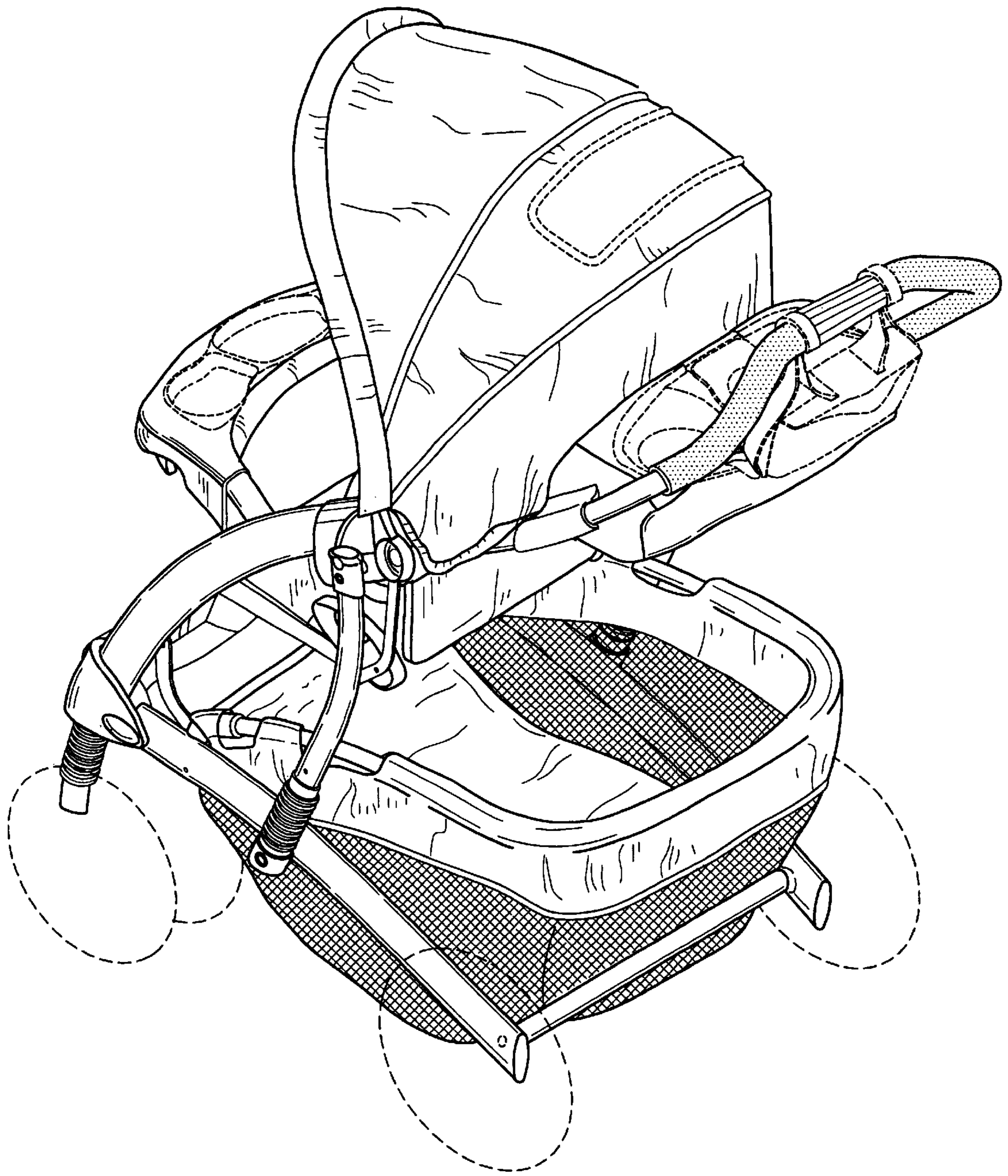

FIG. 2

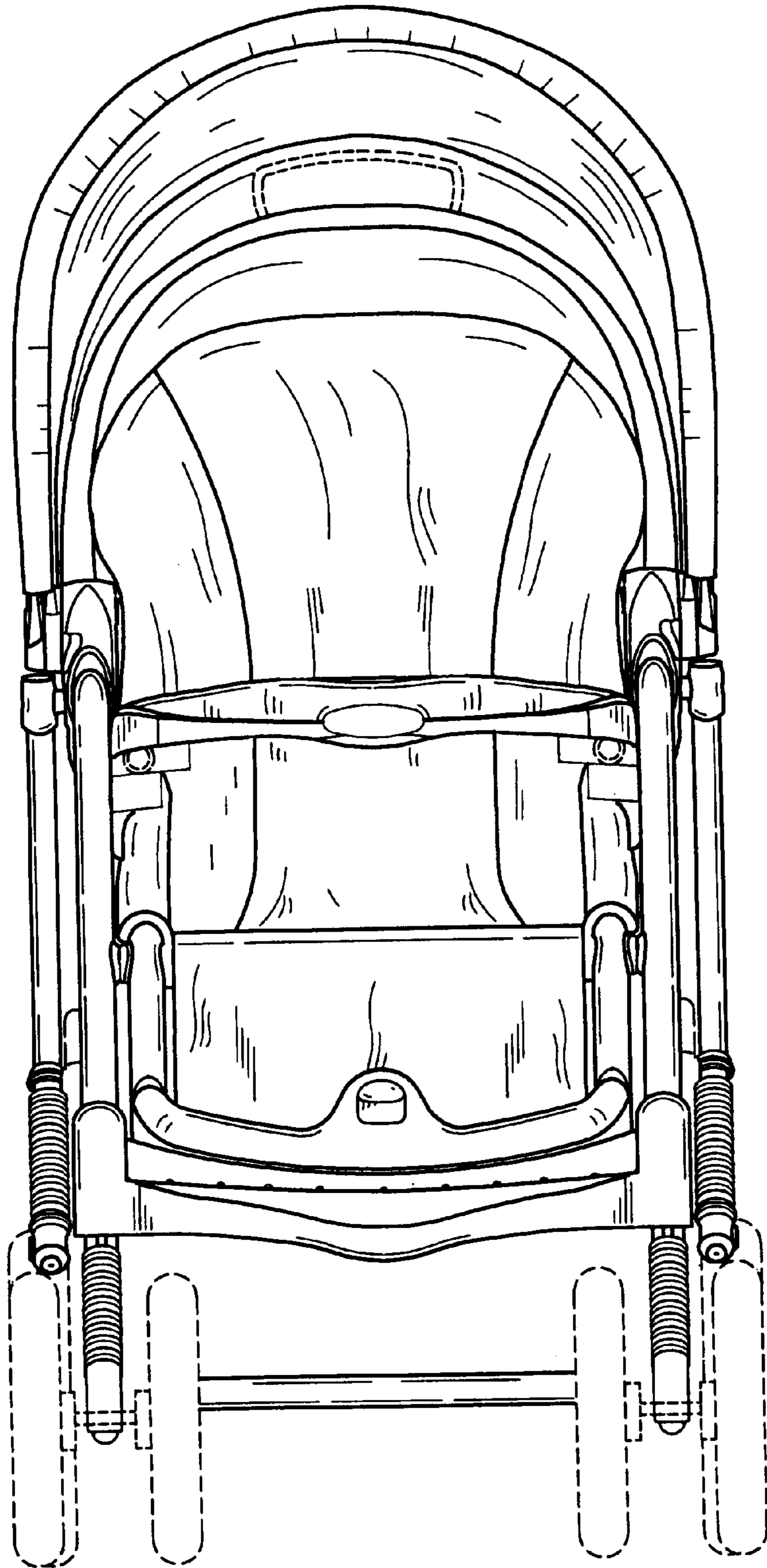

FIG.3

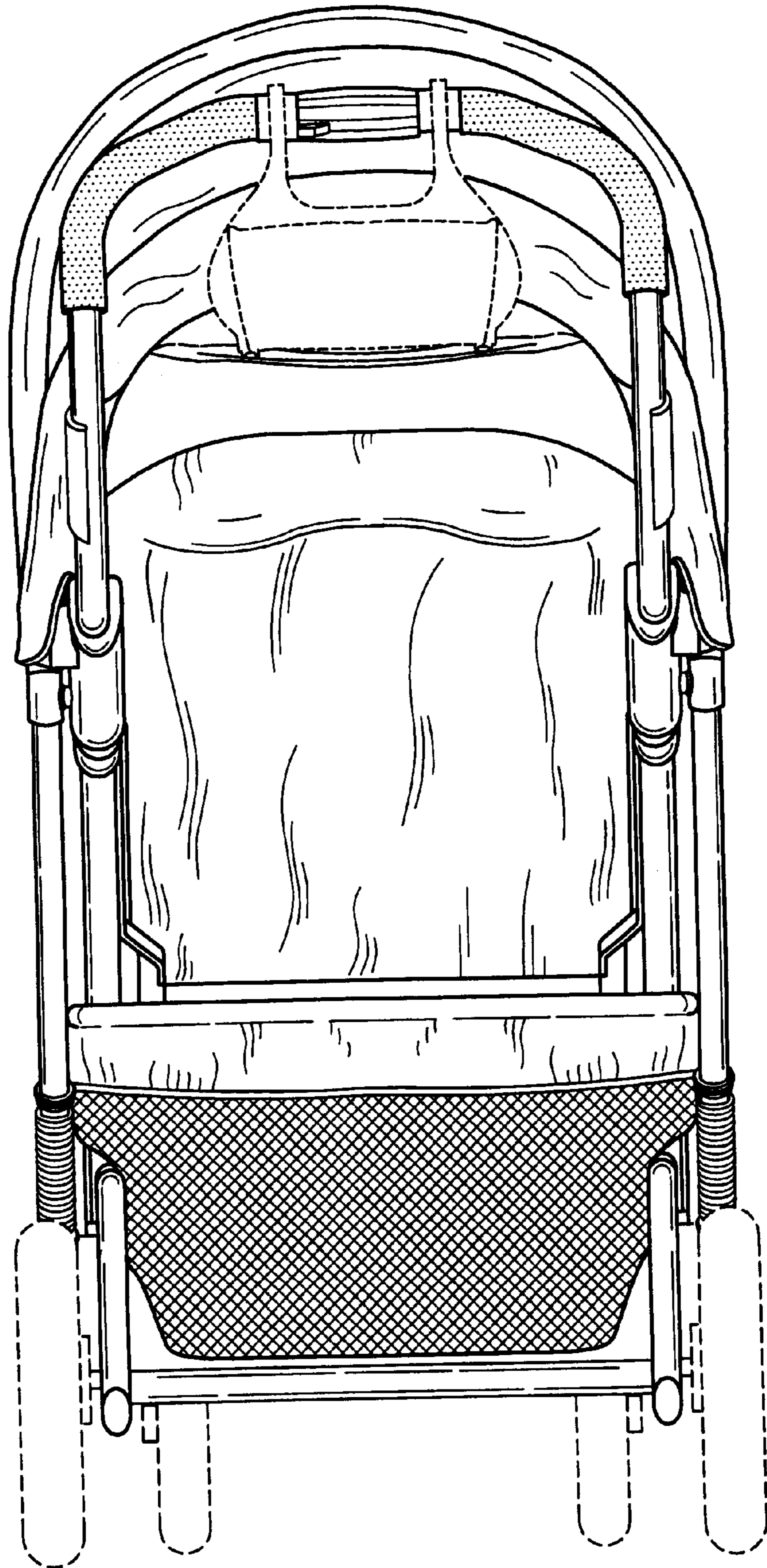

FIG.4

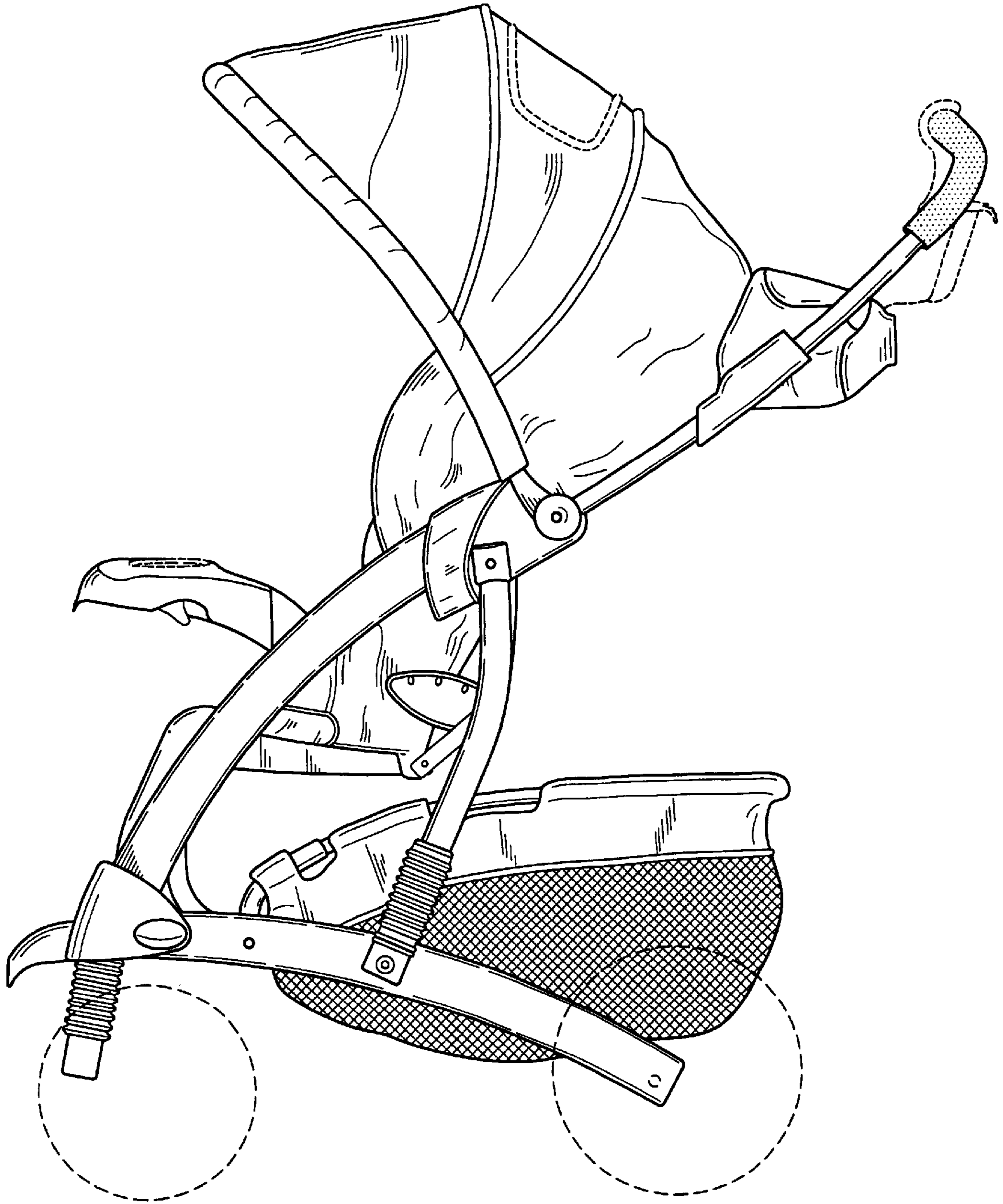

FIG. 5

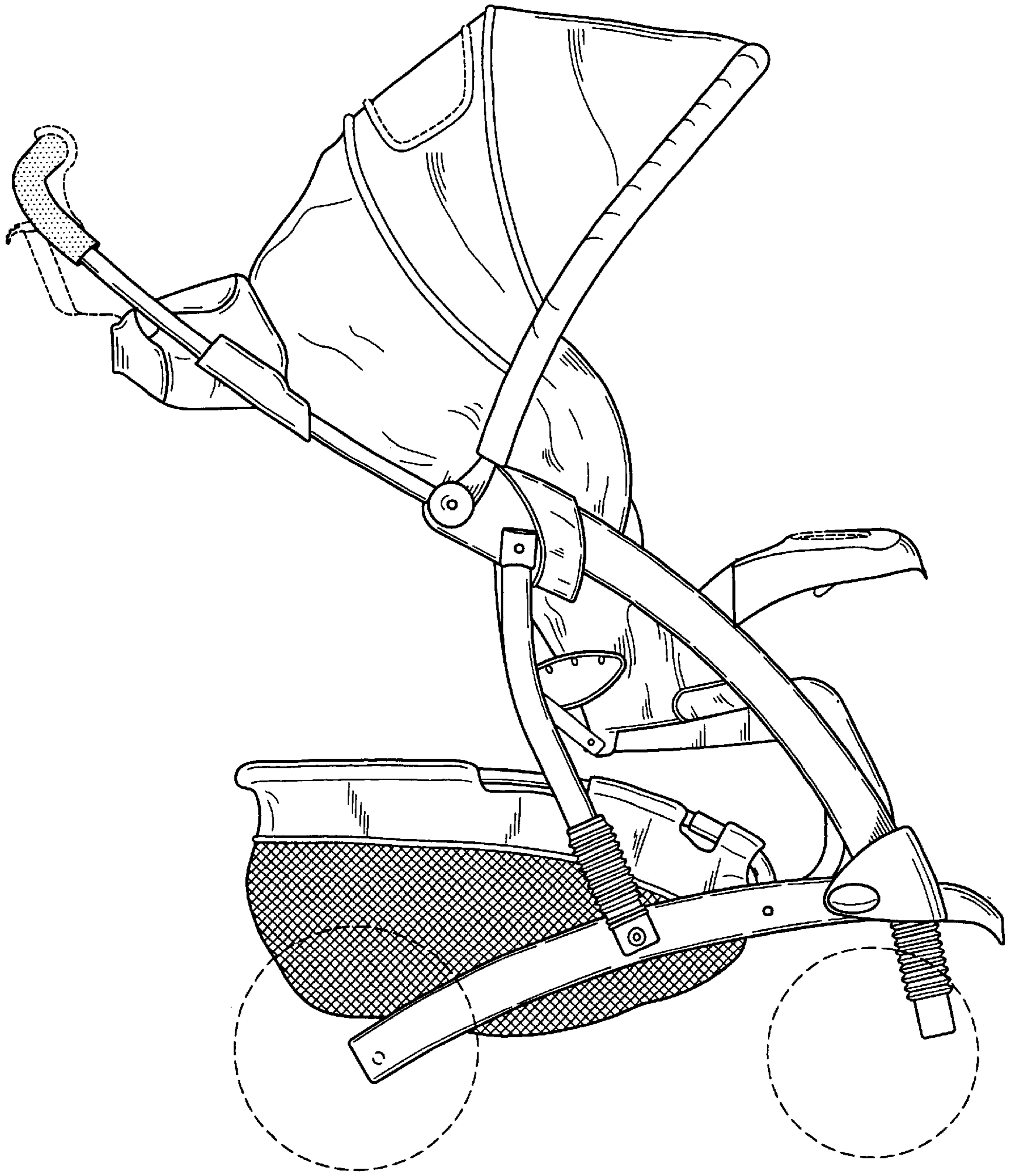

FIG. 6

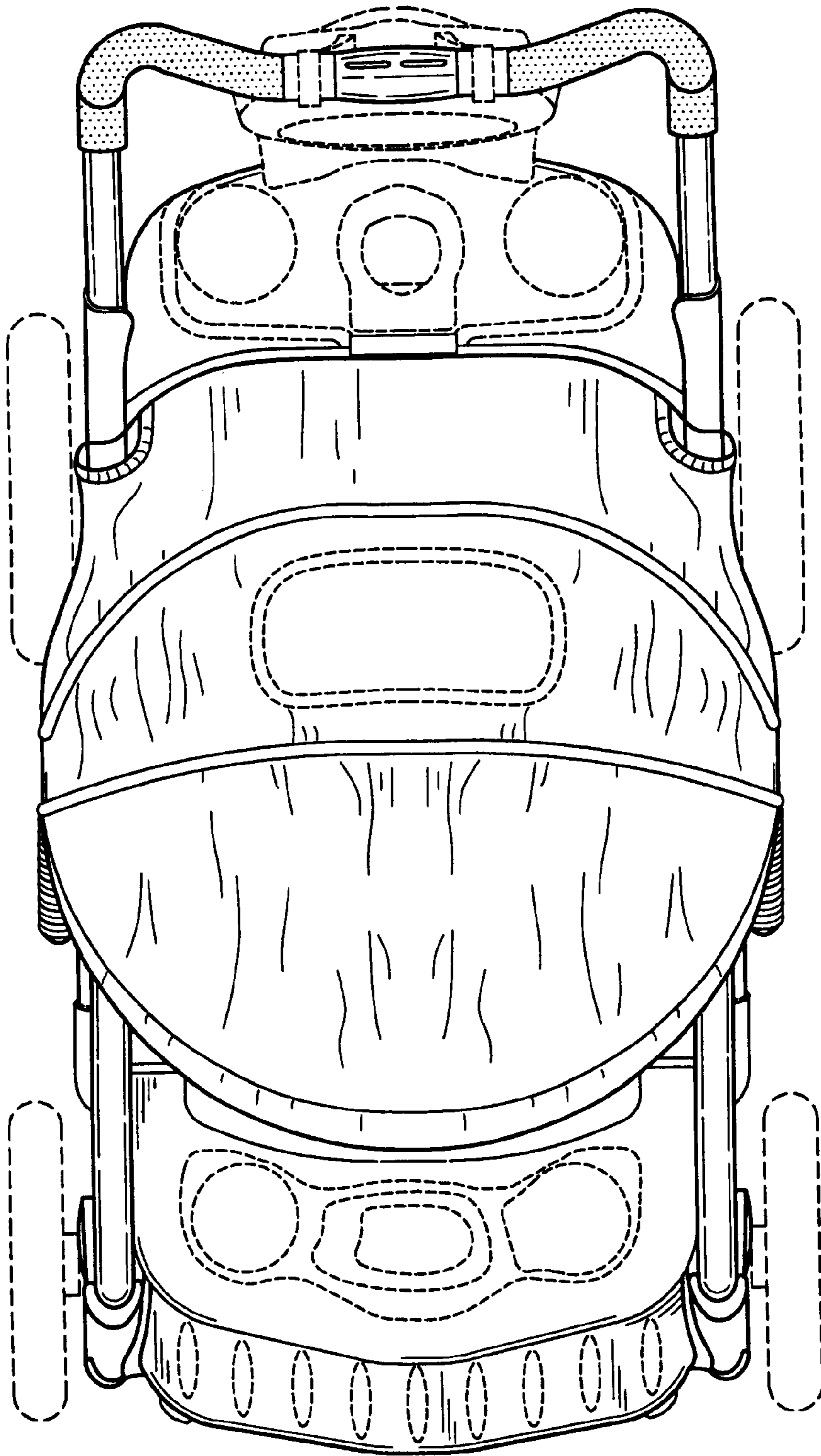

FIG.7

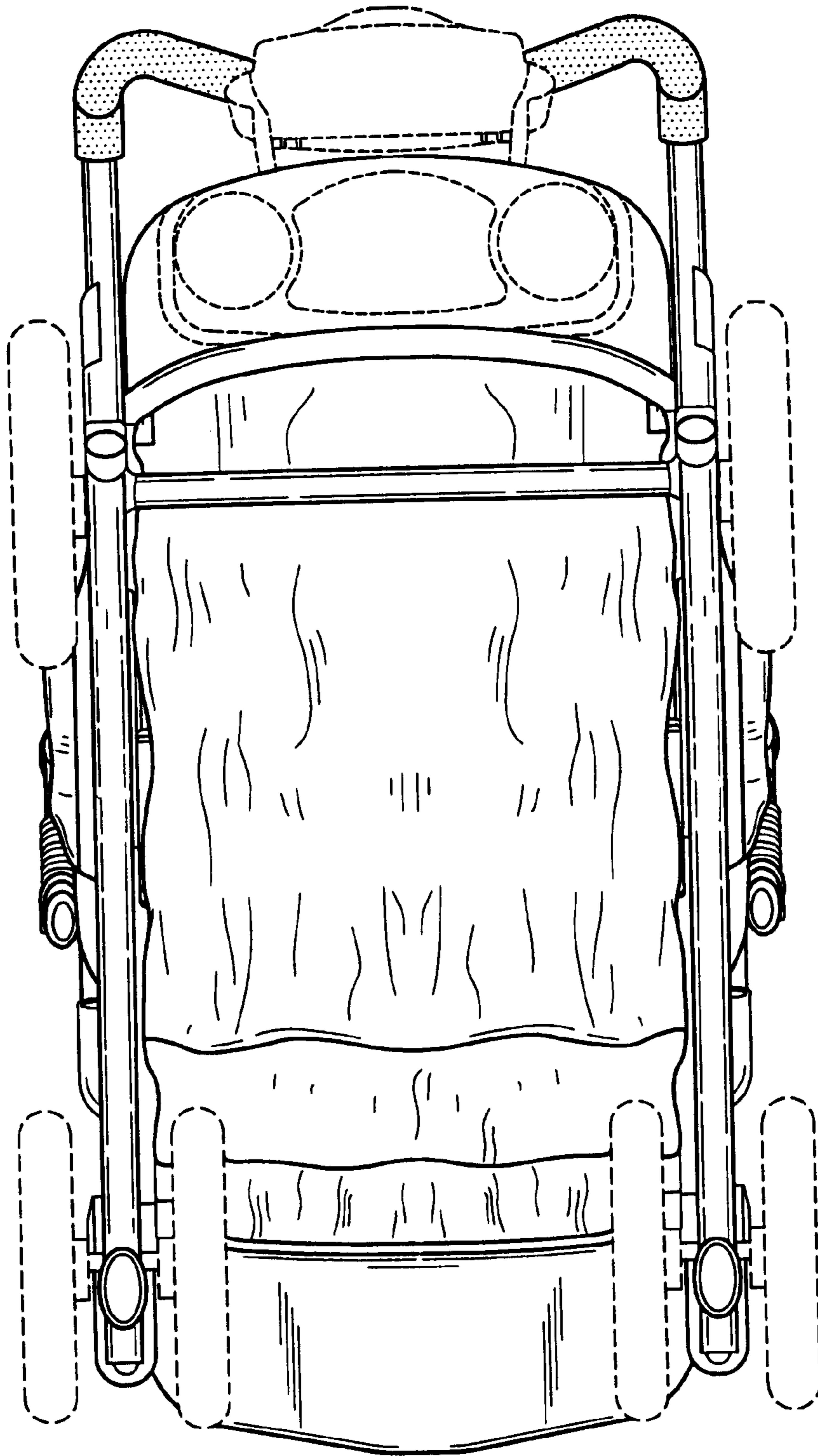

FIG.8