



US00D474706S

(12) **United States Design Patent**  
**Kresse et al.**

(10) **Patent No.:** **US D474,706 S**

(45) **Date of Patent:** **\*\* May 20, 2003**

(54) **NONINTRUSIVE X-RAY-BASED LUGGAGE SCANNER**

6,430,255 B2 \* 8/2002 Fenkart et al. .... 378/57

\* cited by examiner

(75) Inventors: **David E. Kresse**, Walnut Creek, CA (US); **Andrew J. Banchieri**, Newark, CA (US); **Bradley T. Sykes**, Mill Valley, CA (US)

*Primary Examiner*—Antoine Duval Davis  
(74) *Attorney, Agent, or Firm*—Blakely Sokoloff Taylor & Zafman LLP

(73) Assignee: **InVision Technologies, Inc.**, Newark, CA (US)

(57) **CLAIM**

The ornamental design for a nonintrusive x-ray-based luggage scanner, as shown and described.

(\*\*) Term: **14 Years**

**DESCRIPTION**

(21) Appl. No.: **29/164,767**

FIG. 1 is a perspective view of a nonintrusive x-ray-based luggage scanner showing our new design; FIG. 2 is a front view thereof; FIG. 3 is a rear view thereof; FIG. 4 is a top plan view thereof; FIG. 5 is a right side view thereof; FIG. 6 is a left side view thereof; FIG. 7 is a front view thereof, further illustrating two people in phantom lines for purposes of providing scale to the scanner; and, FIG. 8 is a perspective view thereof with a door in an open position.

(22) Filed: **Jul. 29, 2002**

(51) **LOC (7) Cl.** ..... **10-05**

(52) **U.S. Cl.** ..... **D10/106**

(58) **Field of Search** ..... D10/46, 104, 106;  
378/98.9, 98.11, 157, 57, 4, 5, 21, 98.12,  
203

(56) **References Cited**

**U.S. PATENT DOCUMENTS**

4,884,289 A \* 11/1989 Glockmann et al. .... 378/57  
5,870,449 A \* 2/1999 Lee et al. .... 378/57

**1 Claim, 8 Drawing Sheets**

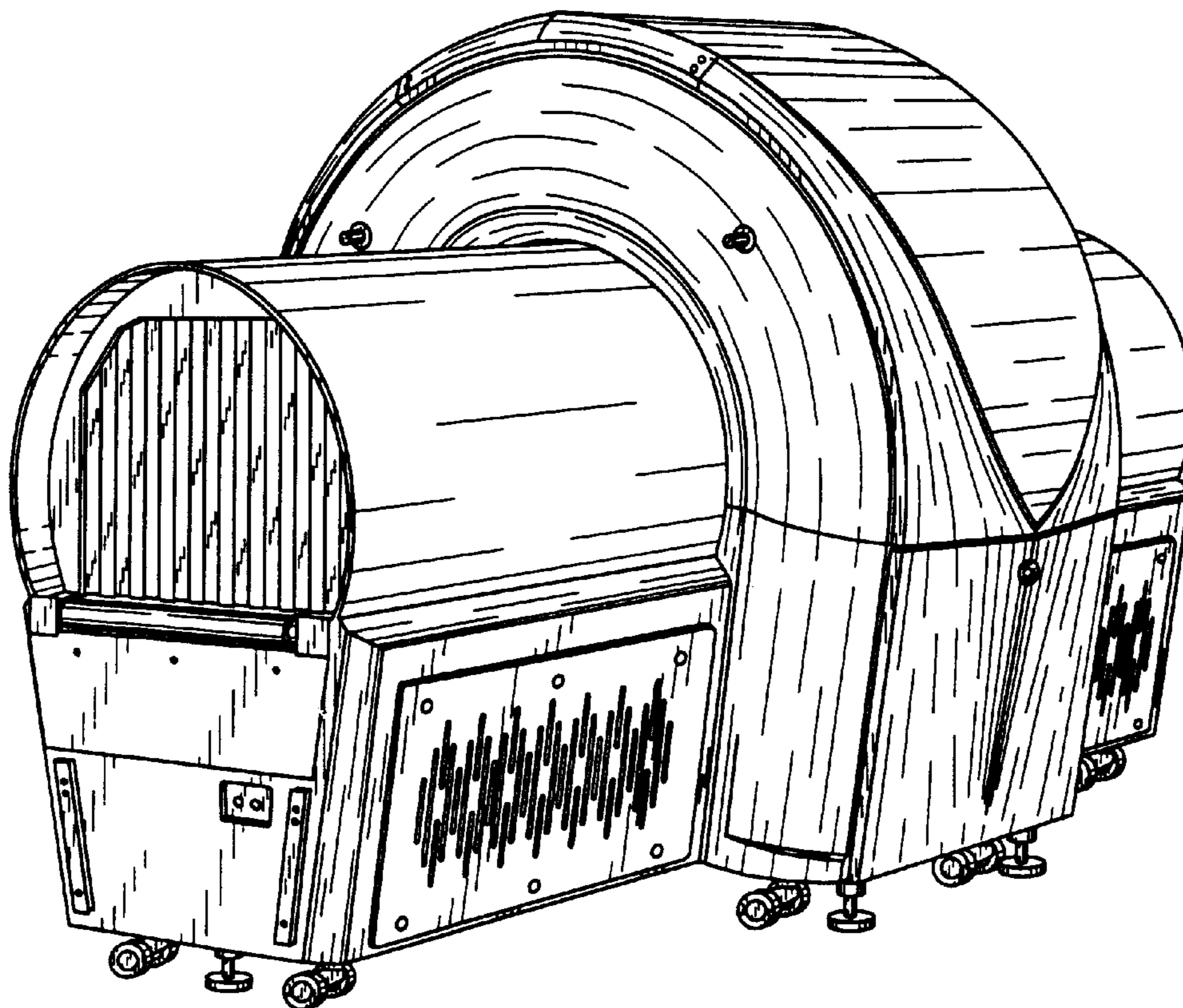

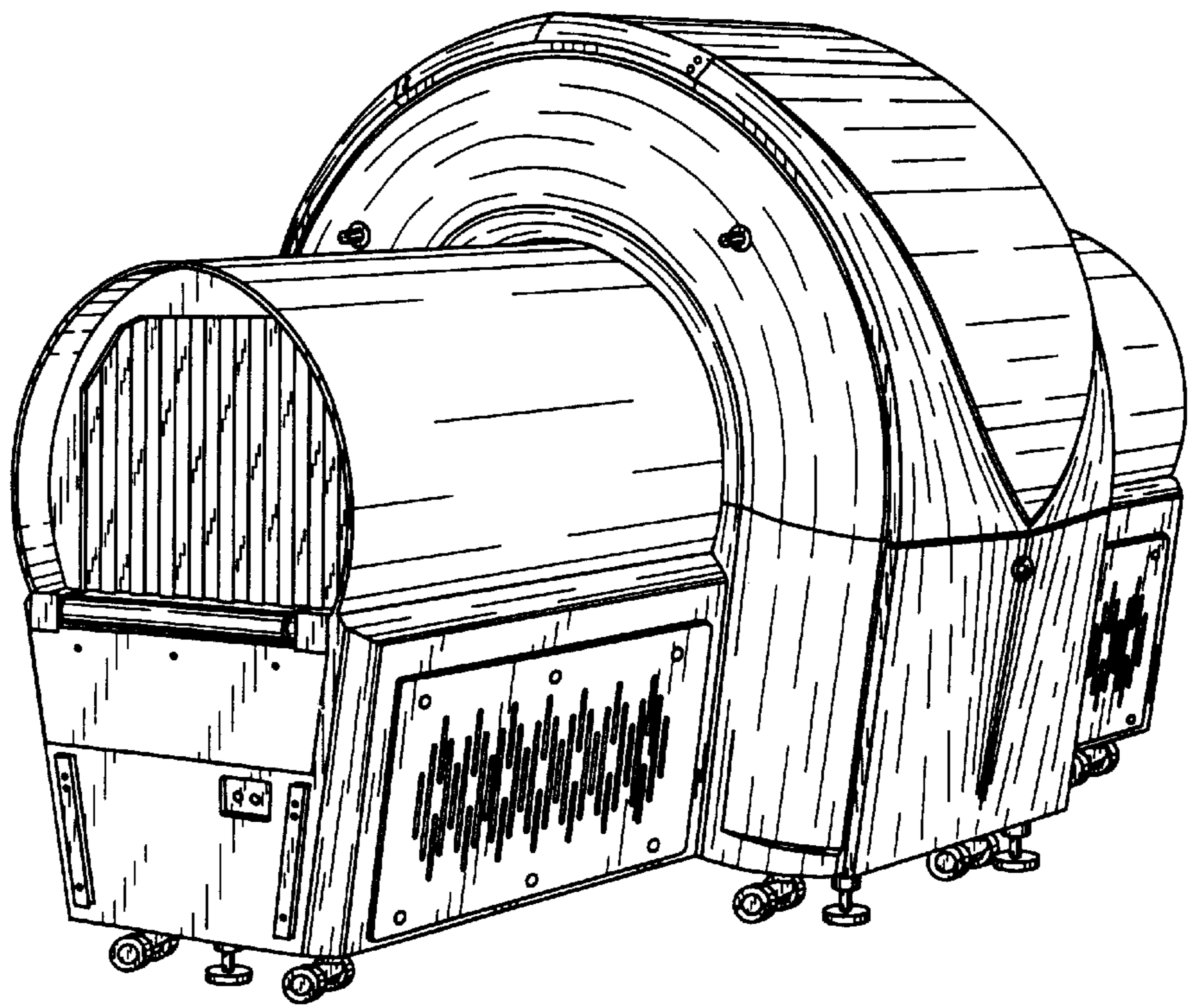

FIG. 1

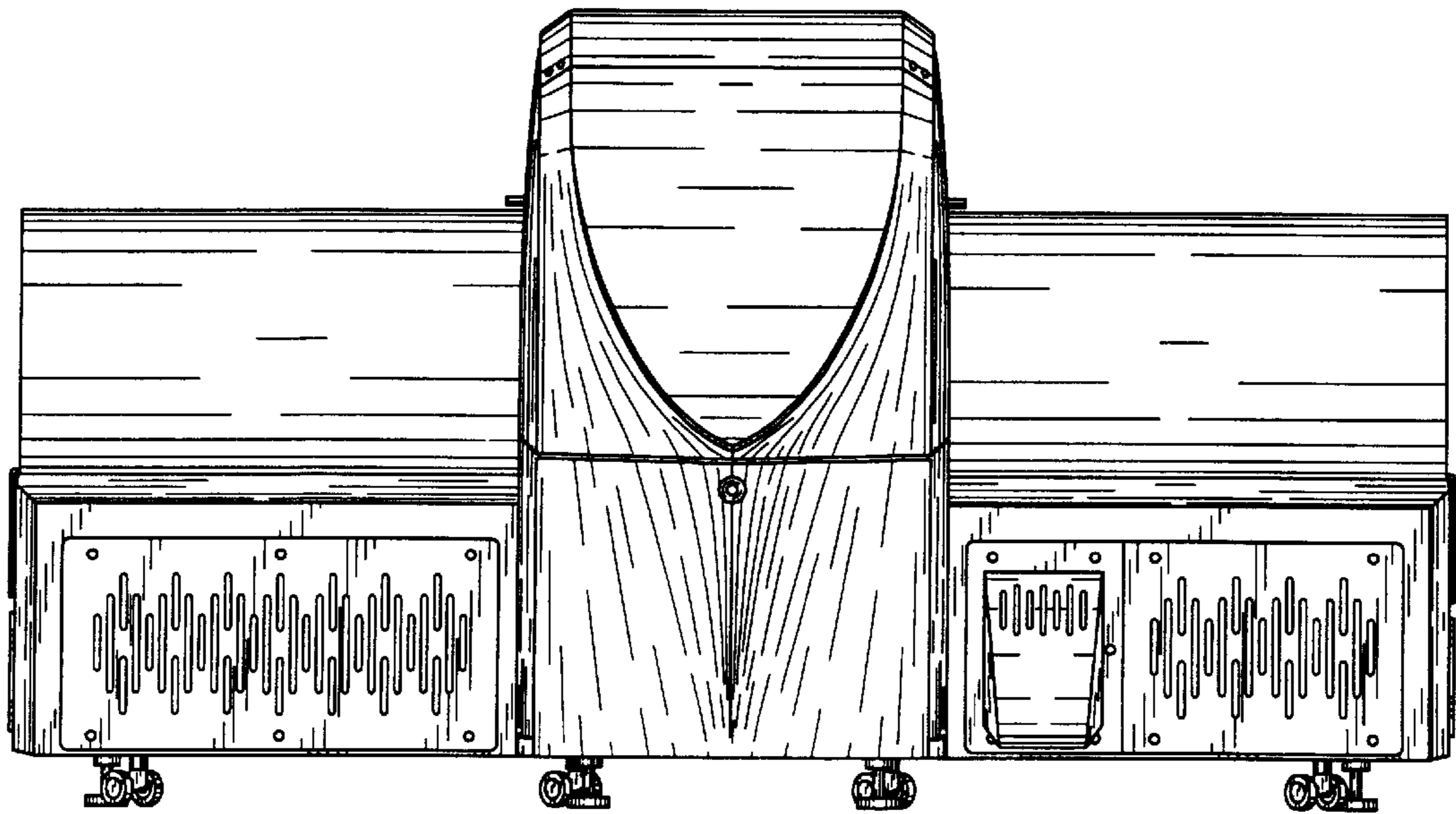

FIG. 2

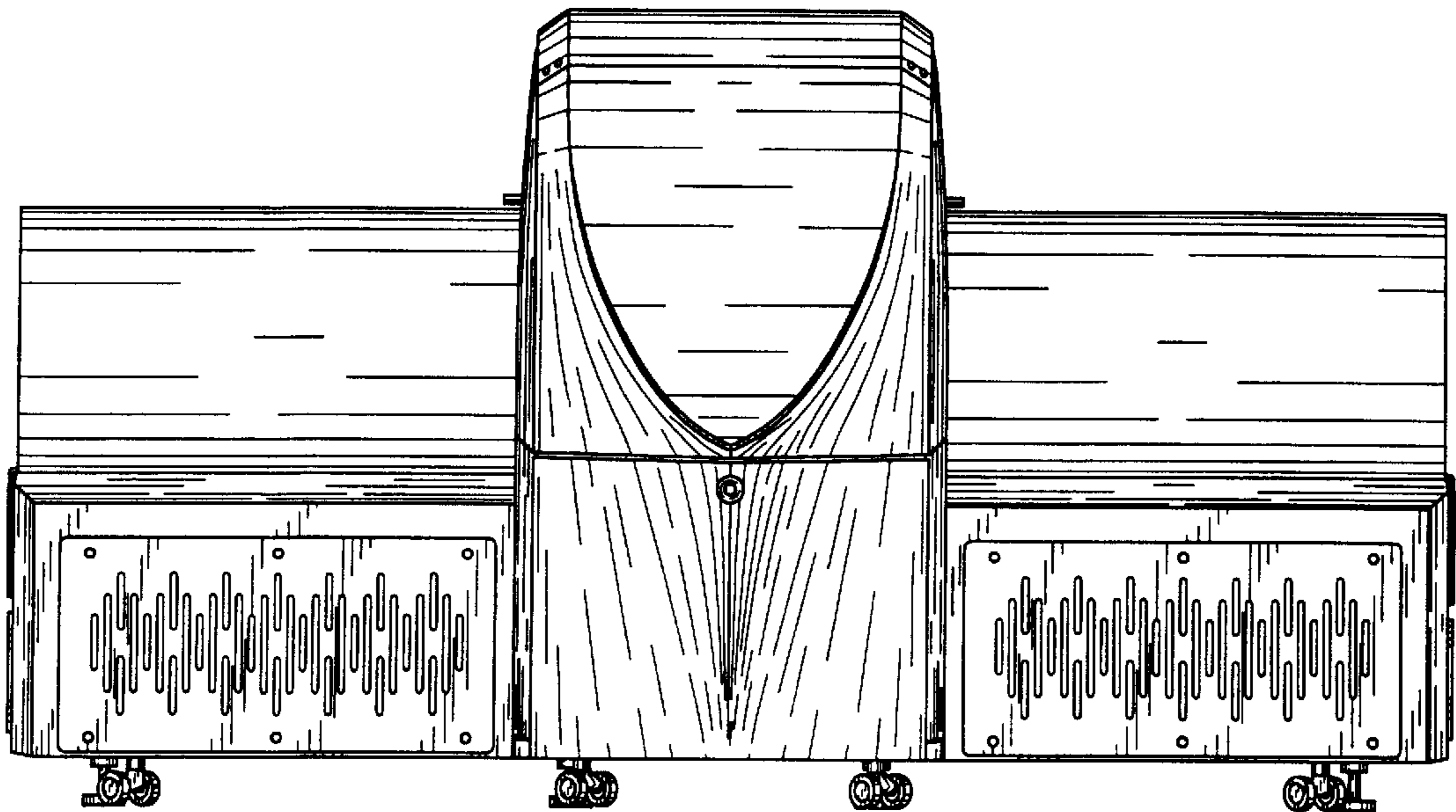

FIG. 3

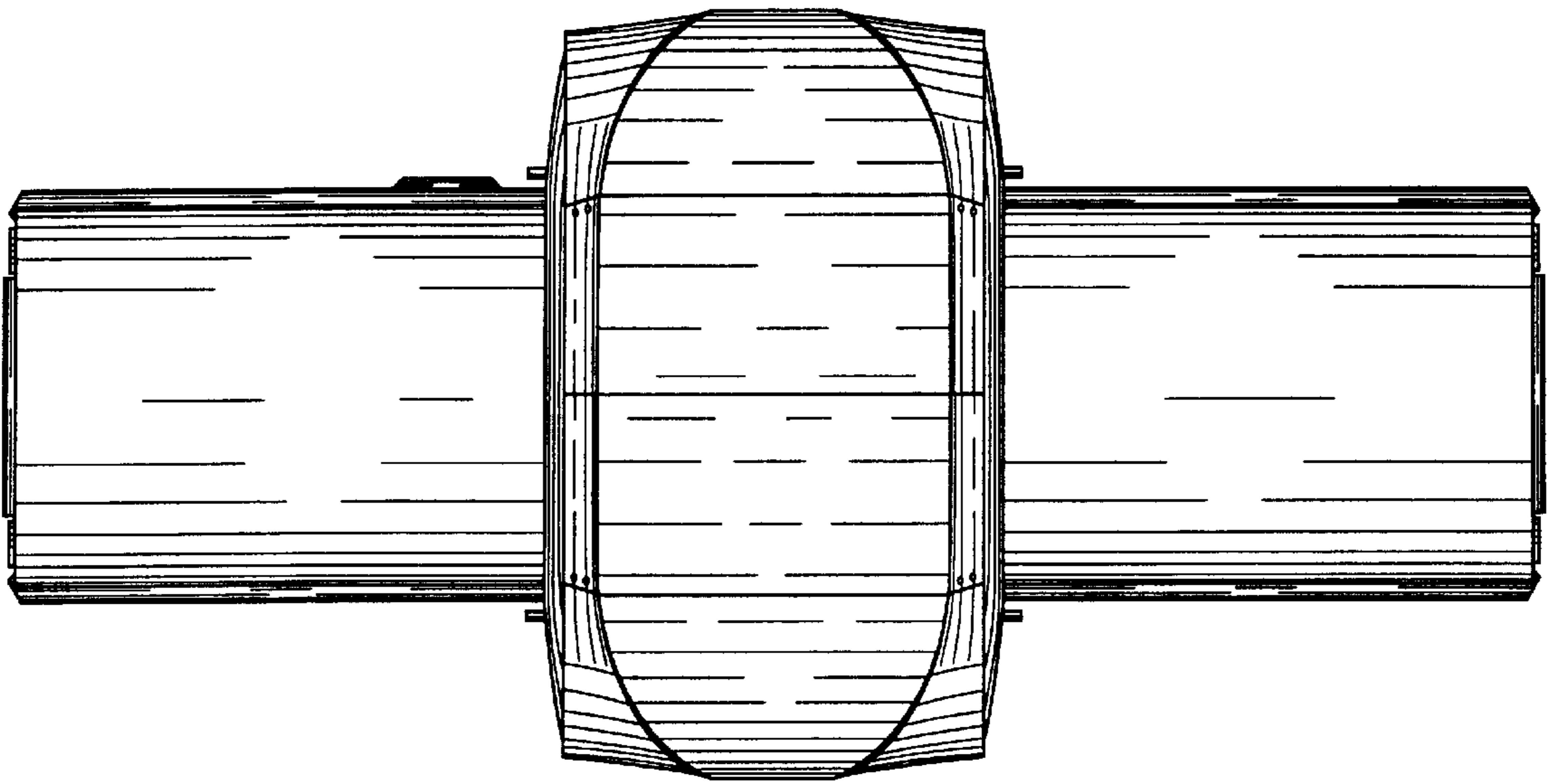

FIG. 4

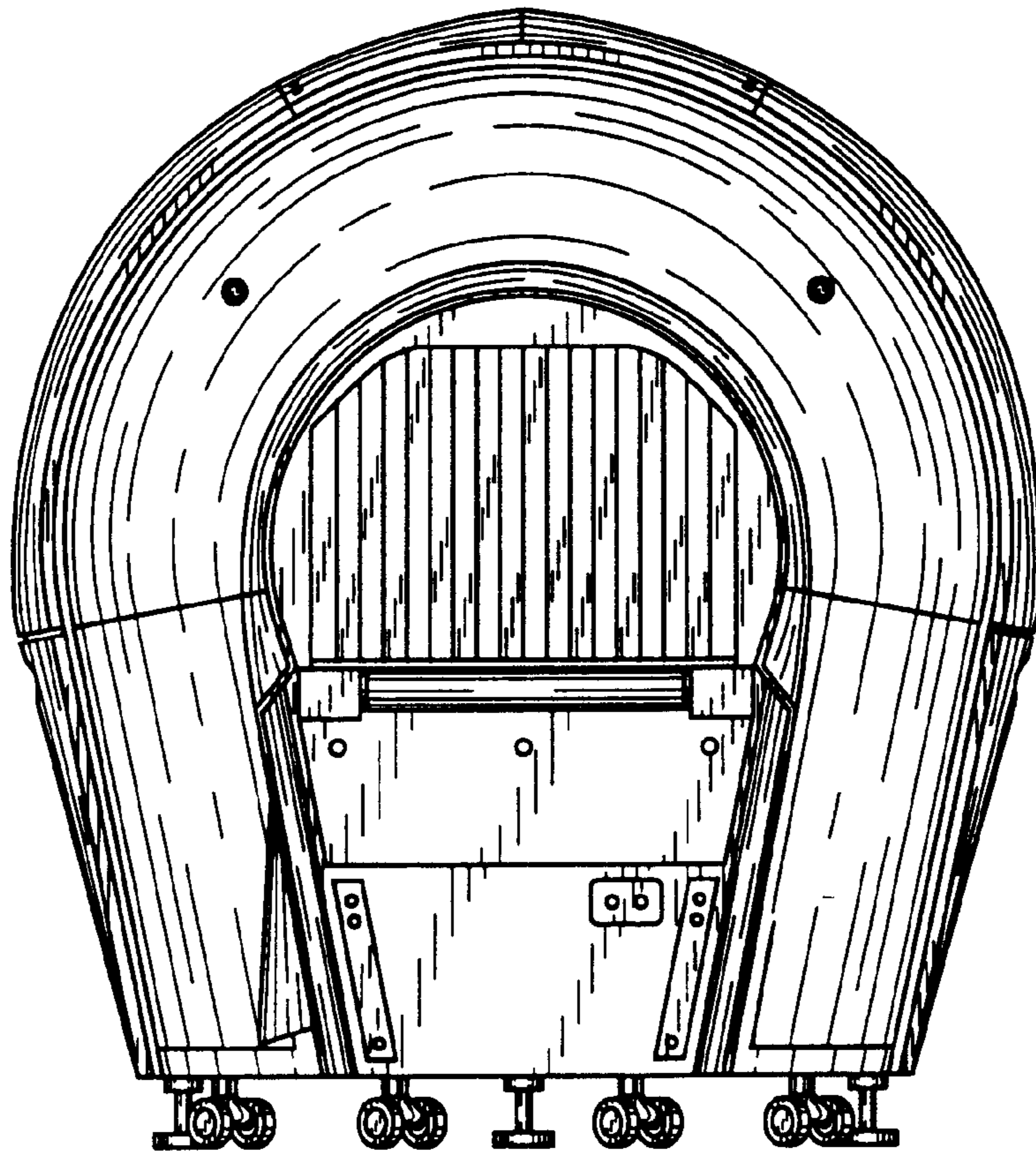

FIG. 5

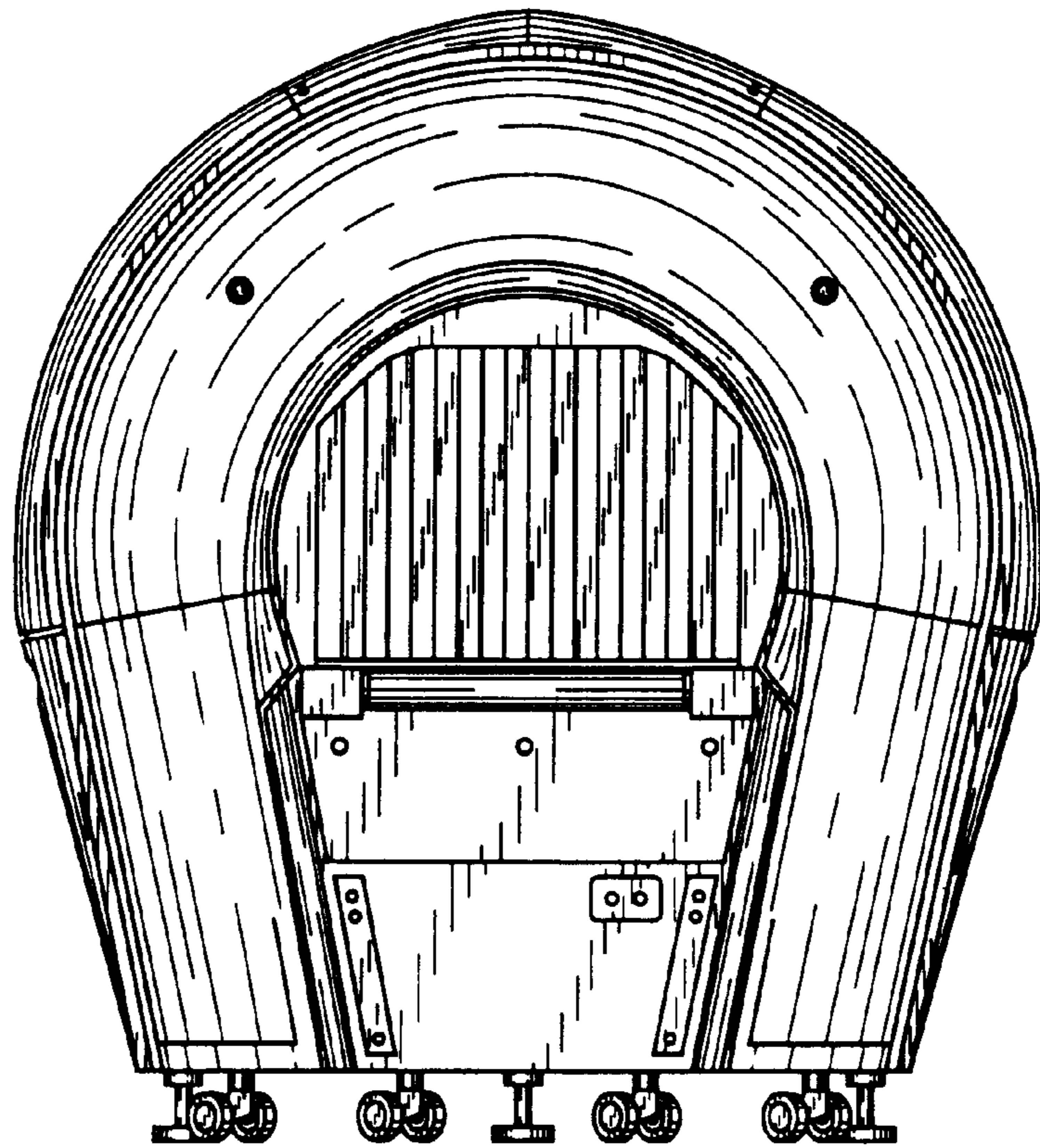

FIG. 6

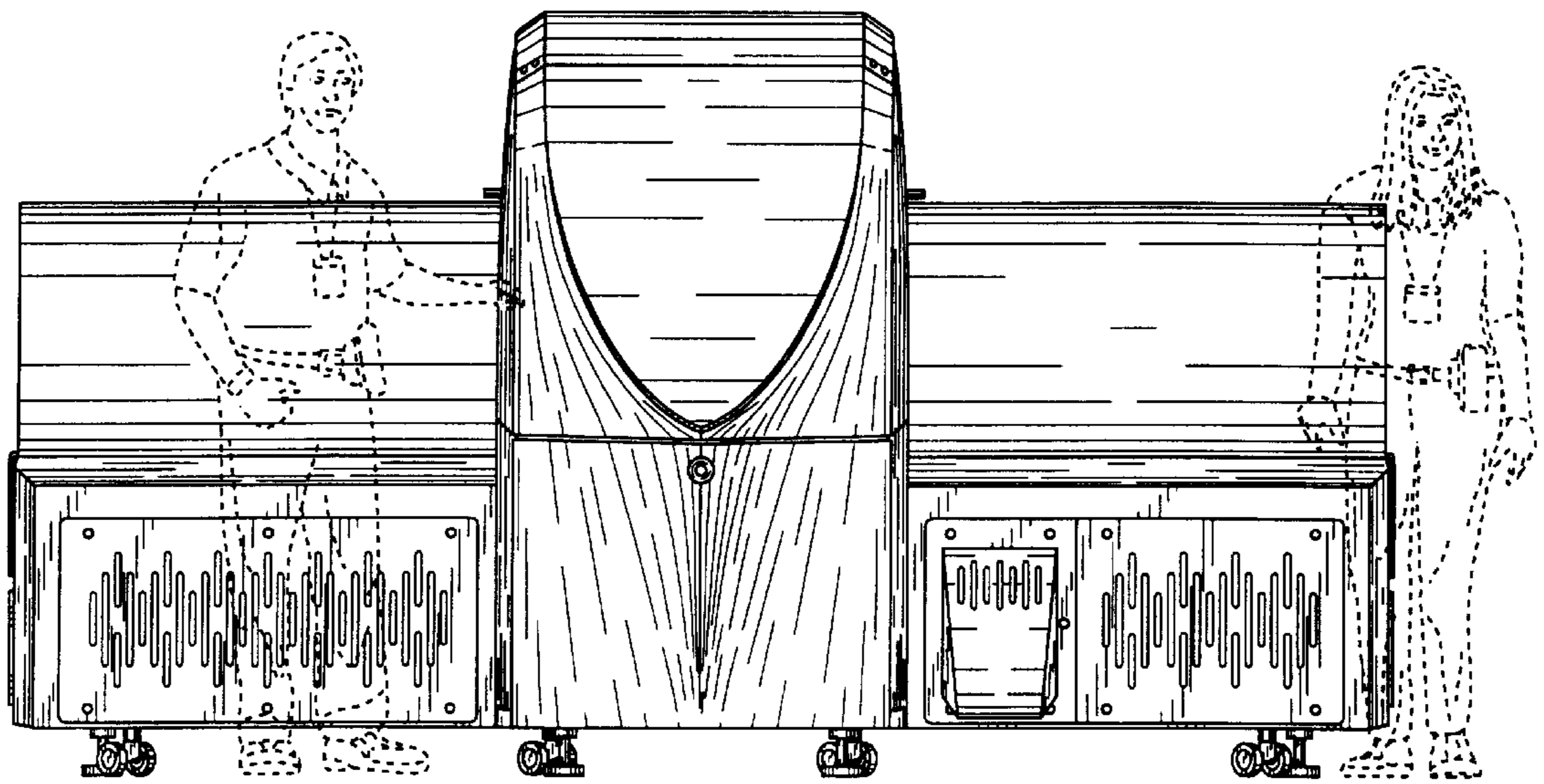

FIG. 7



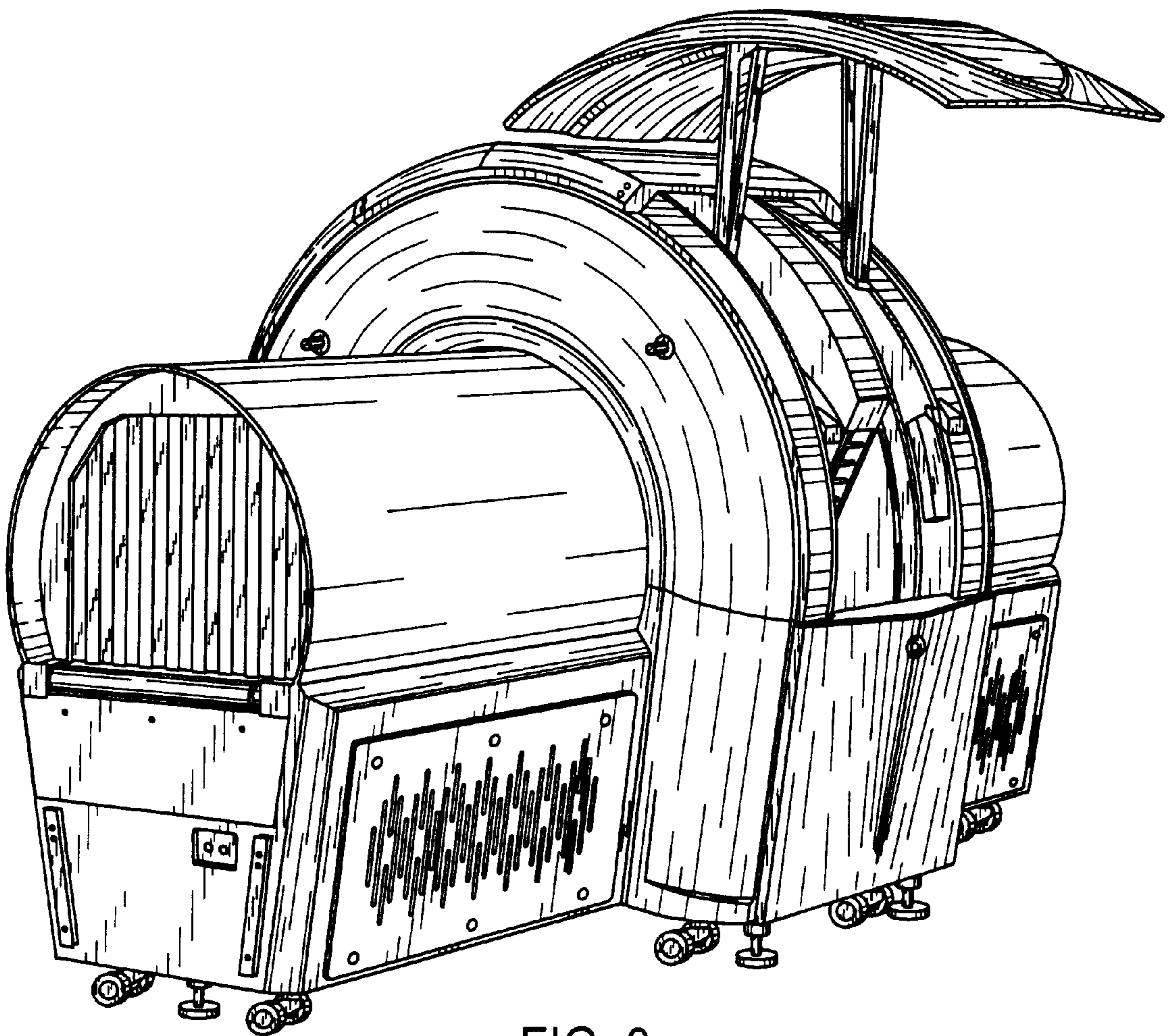

FIG. 8