



US00D474676S

(12) **United States Design Patent** (10) **Patent No.:** **US D474,676 S**
Bainbridge (45) **Date of Patent:** **** May 20, 2003**

(54) **BRACKET ASSEMBLY**

(76) Inventor: **James R. Bainbridge**, 22724 96th Ave., Marcellus, MI (US) 49067

(**) Term: **14 Years**

(21) Appl. No.: **29/154,650**

(22) Filed: **Jan. 25, 2002**

(51) **LOC (7) Cl.** **08-05**

(52) **U.S. Cl.** **D8/354; D8/380**

(58) **Field of Search** D8/380, 349, 373, D8/354; D25/133; 248/200, 68.1, 300, 225.11, 49, 73, 146, 223.41, 903, 910, 65, 534, 519, 523, 346.01, 346.02, 346.03, 228.1, 247, 246; 211/13.1, 22

(56) **References Cited**

U.S. PATENT DOCUMENTS

| | | | | |
|----------------|---------|--------------|-------|---------|
| D226,421 S * | 3/1973 | Rieb | | D8/380 |
| D248,447 S * | 7/1978 | Hornung | | D8/354 |
| D322,551 S * | 12/1991 | Tosevski | | D8/349 |
| 5,524,856 A * | 6/1996 | Neely et al. | | 248/534 |
| 6,244,558 B1 * | 6/2001 | Castle | | 248/544 |

* cited by examiner

Primary Examiner—Pamela Burgess

(74) *Attorney, Agent, or Firm*—Flynn, Thiel, Boutell & Tanis, P.C.

(57) **CLAIM**

The ornamental designs for a bracket assembly, as shown and described.

DESCRIPTION

FIG. 1 is a top, right, front isometric view of a first

embodiment of a bracket assembly, embodying my new design;

FIG. 2 is a front view thereof;

FIG. 3 is a right side view thereof;

FIG. 4 is a rear view thereof;

FIG. 5 is a top view thereof;

FIG. 6 is a bottom view thereof;

FIG. 7 is a top, right, front isometric view of a second embodiment of a bracket assembly, embodying my new design;

FIG. 8 is a front view thereof;

FIG. 9 is a right side view thereof;

FIG. 10 is a rear view thereof;

FIG. 11 is a top view thereof;

FIG. 12 is a bottom view thereof;

FIG. 13 is a top, right, front isometric view of a third embodiment of a bracket assembly, embodying my new design;

FIG. 14 is a front view thereof;

FIG. 15 is a right side view thereof;

FIG. 16 is a rear view thereof;

FIG. 17 is a top view thereof;

FIG. 18 is a bottom view thereof;

FIG. 19 is a top, right, front isometric view of a fourth embodiment of a bracket assembly, embodying my new design;

FIG. 20 is a front view thereof;

FIG. 21 is a right side view thereof;

FIG. 22 is a rear view thereof;

FIG. 23 is a top view thereof; and,

FIG. 24 is a bottom view thereof.

1 Claim, 20 Drawing Sheets

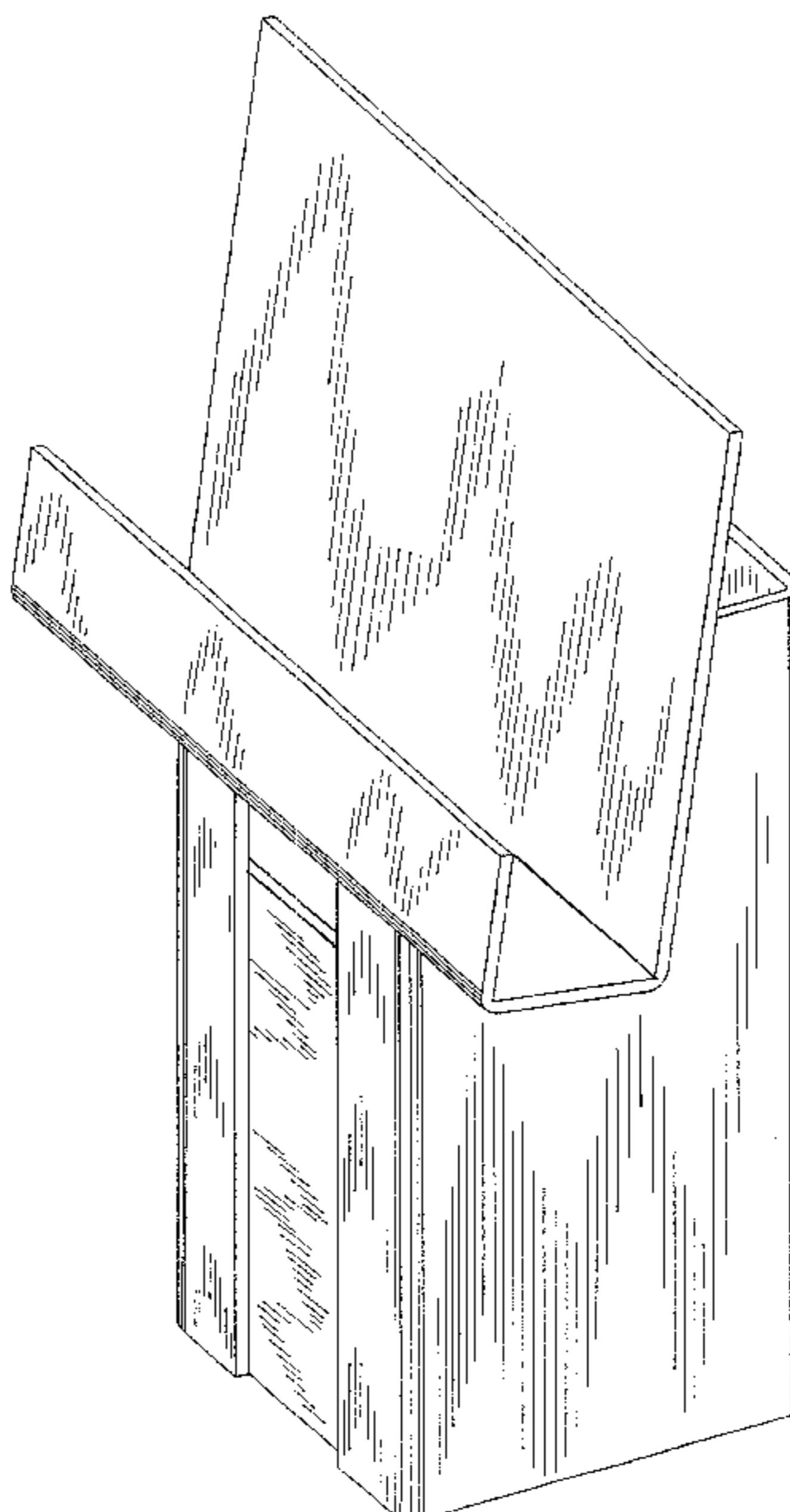

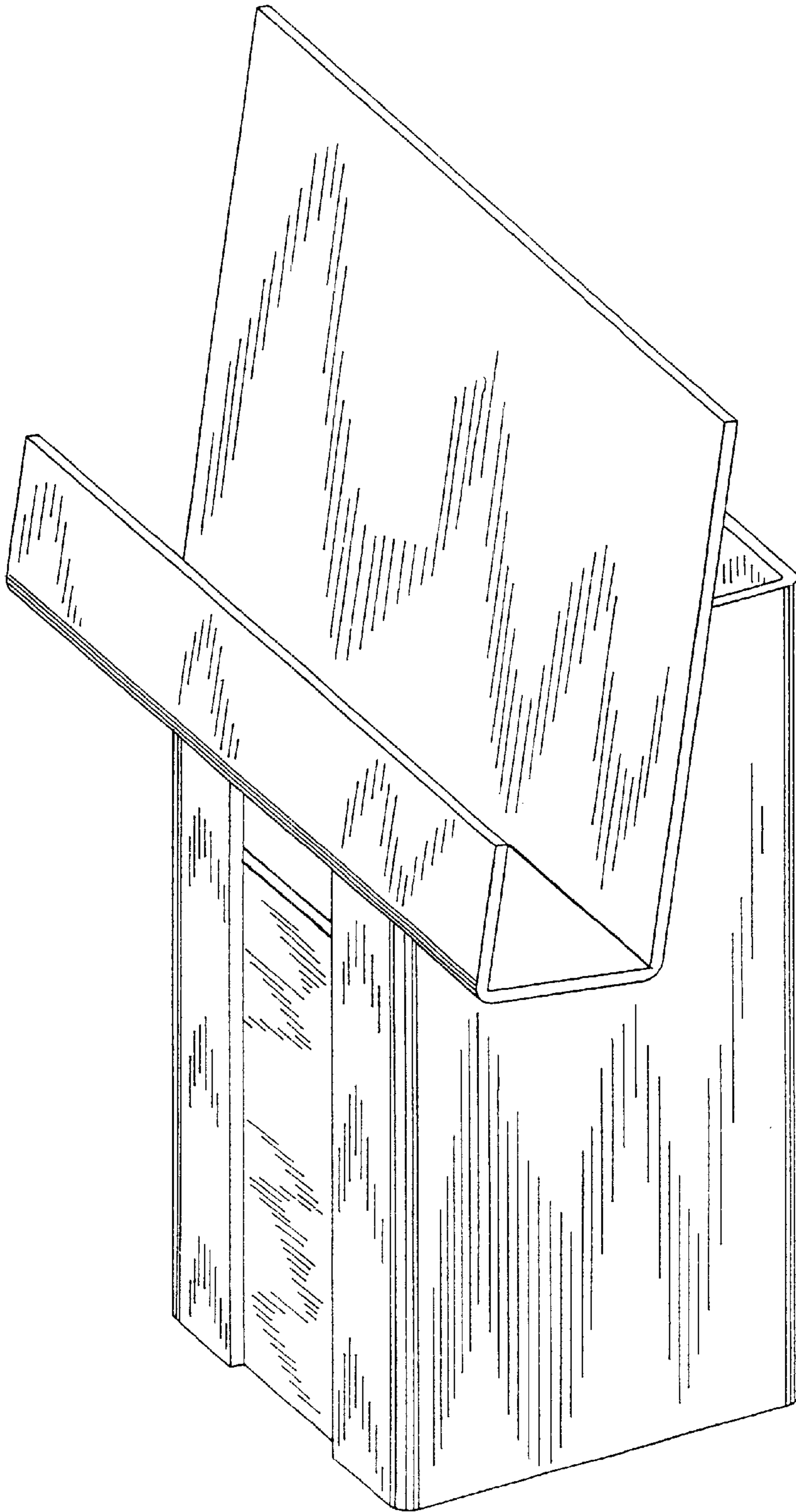

FIG. 1

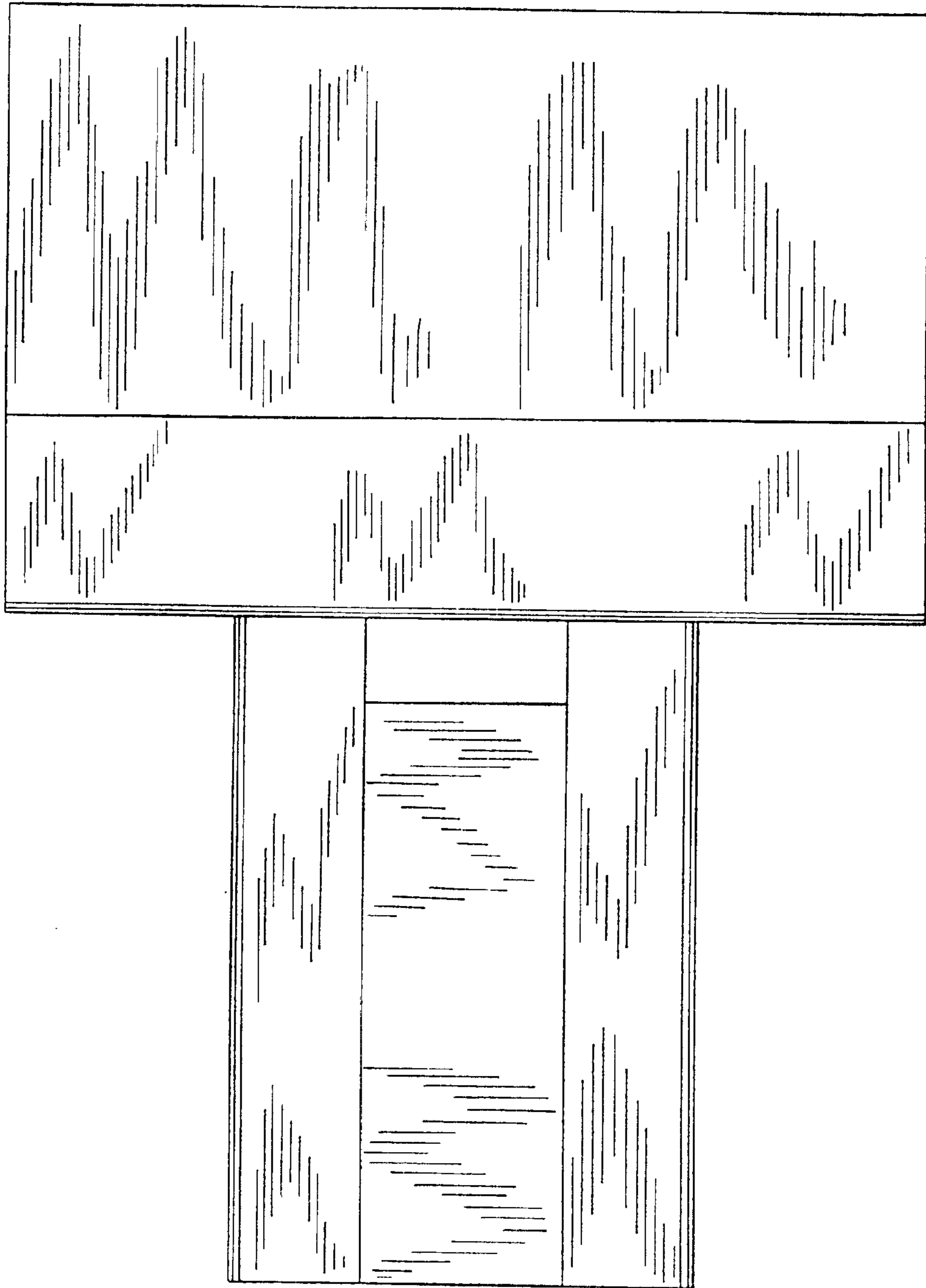

FIG. 2

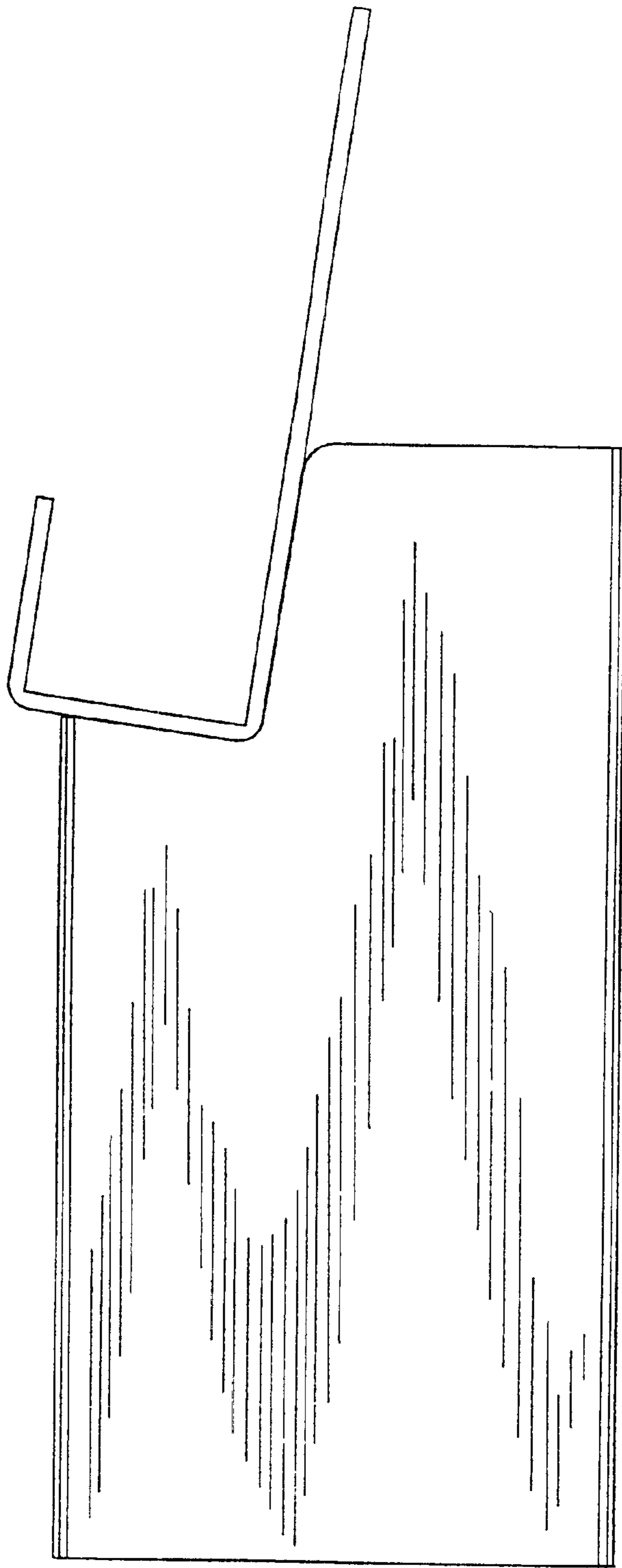

FIG. 3

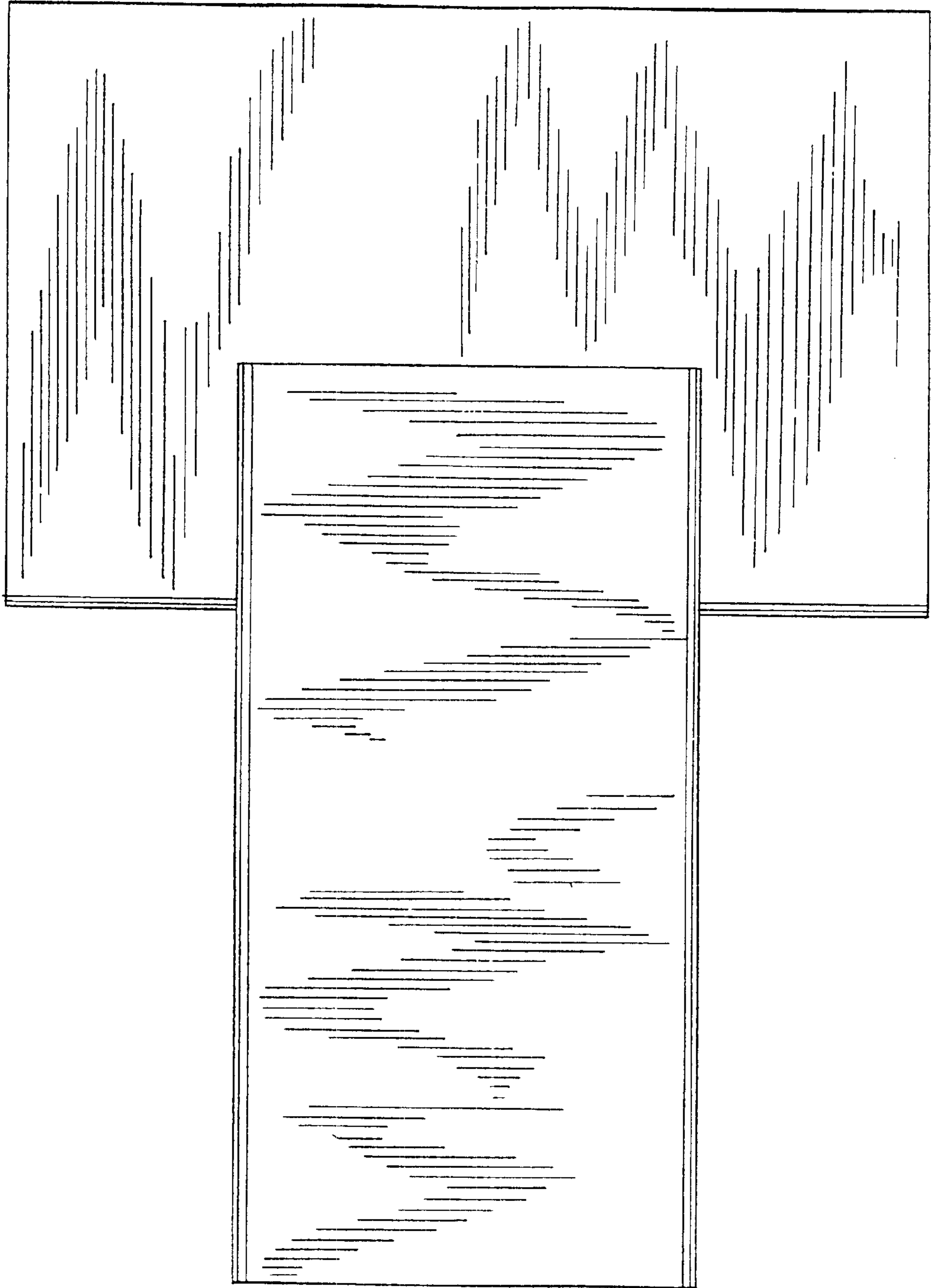

FIG. 4

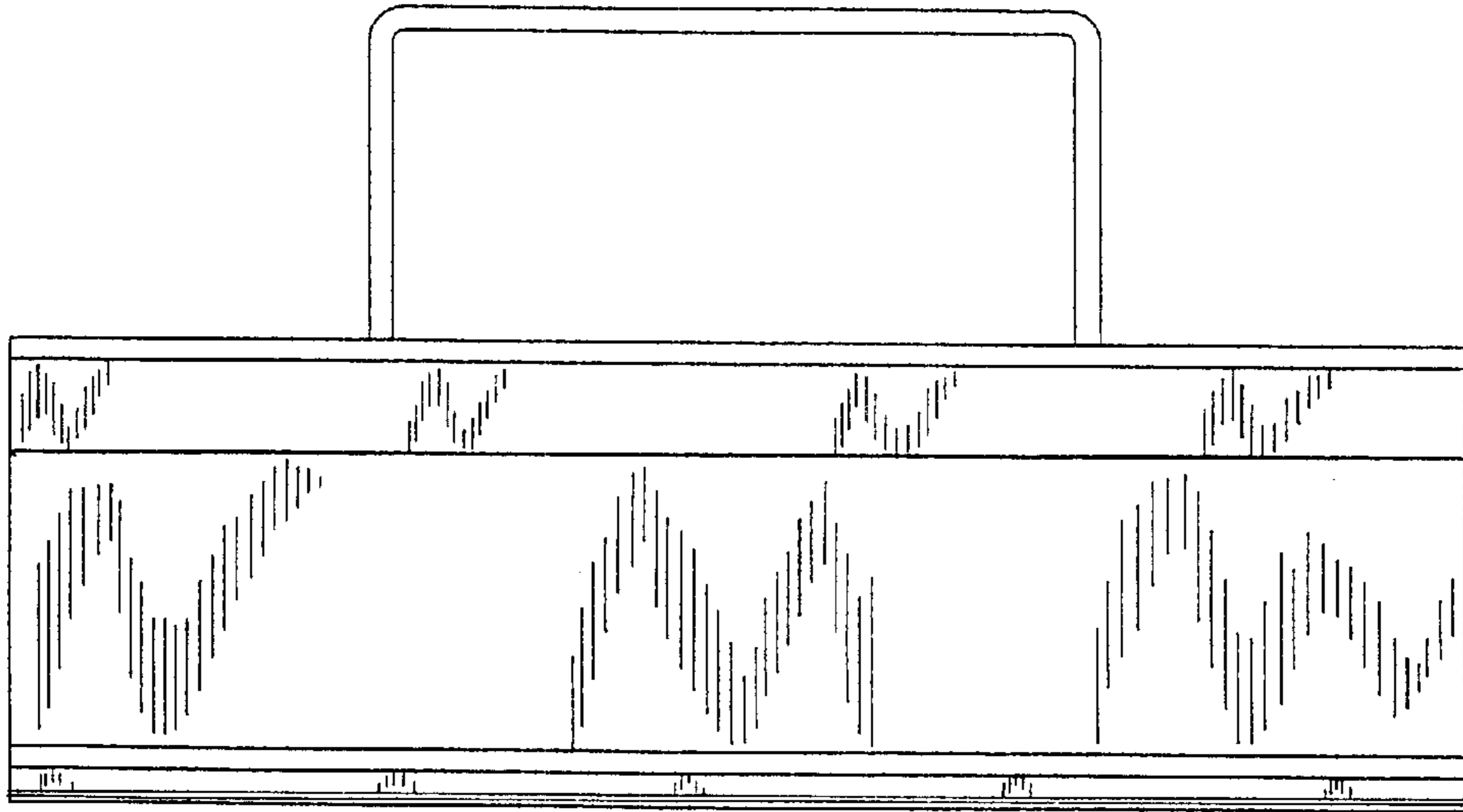

FIG. 5

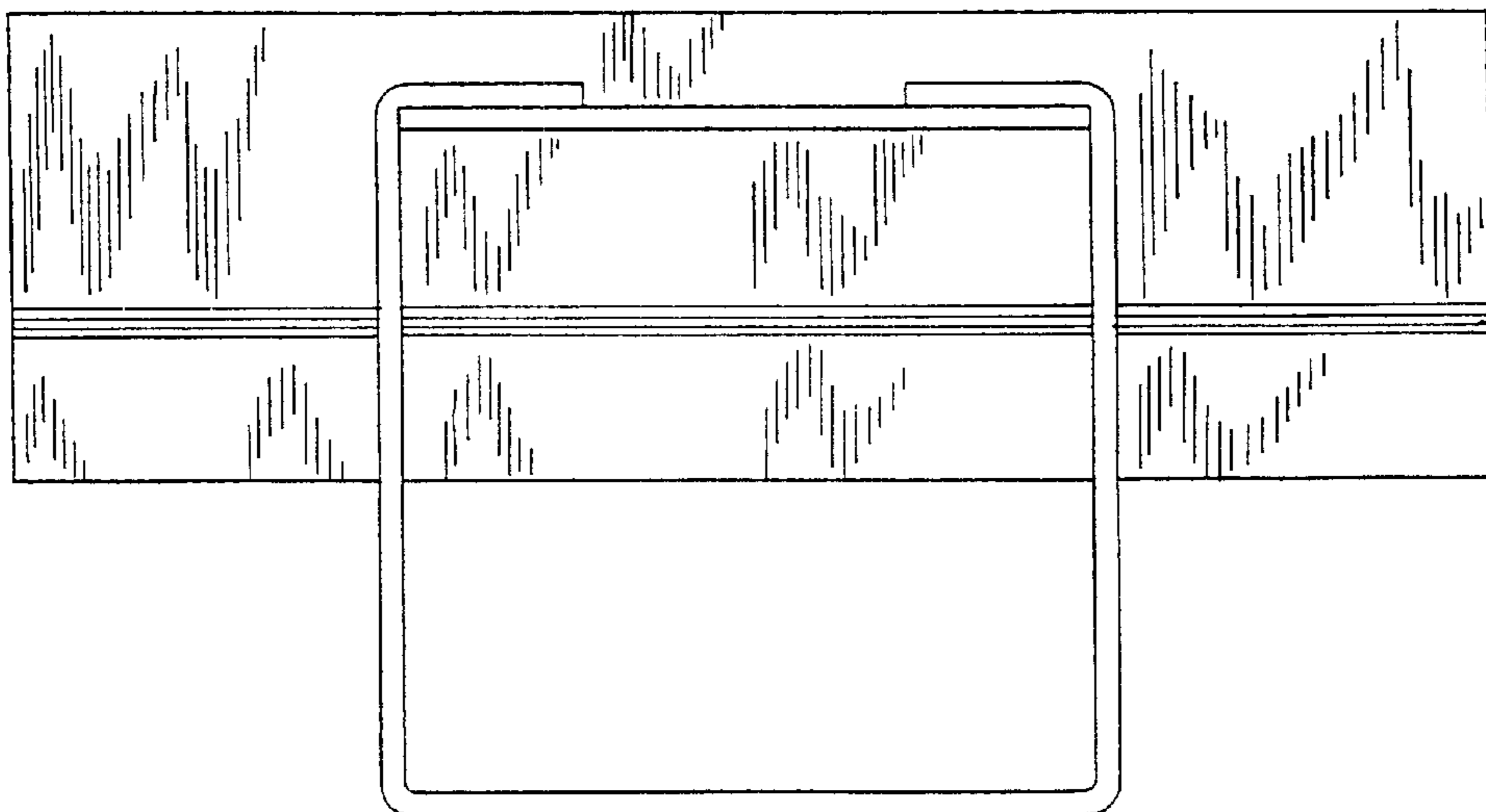

FIG. 6

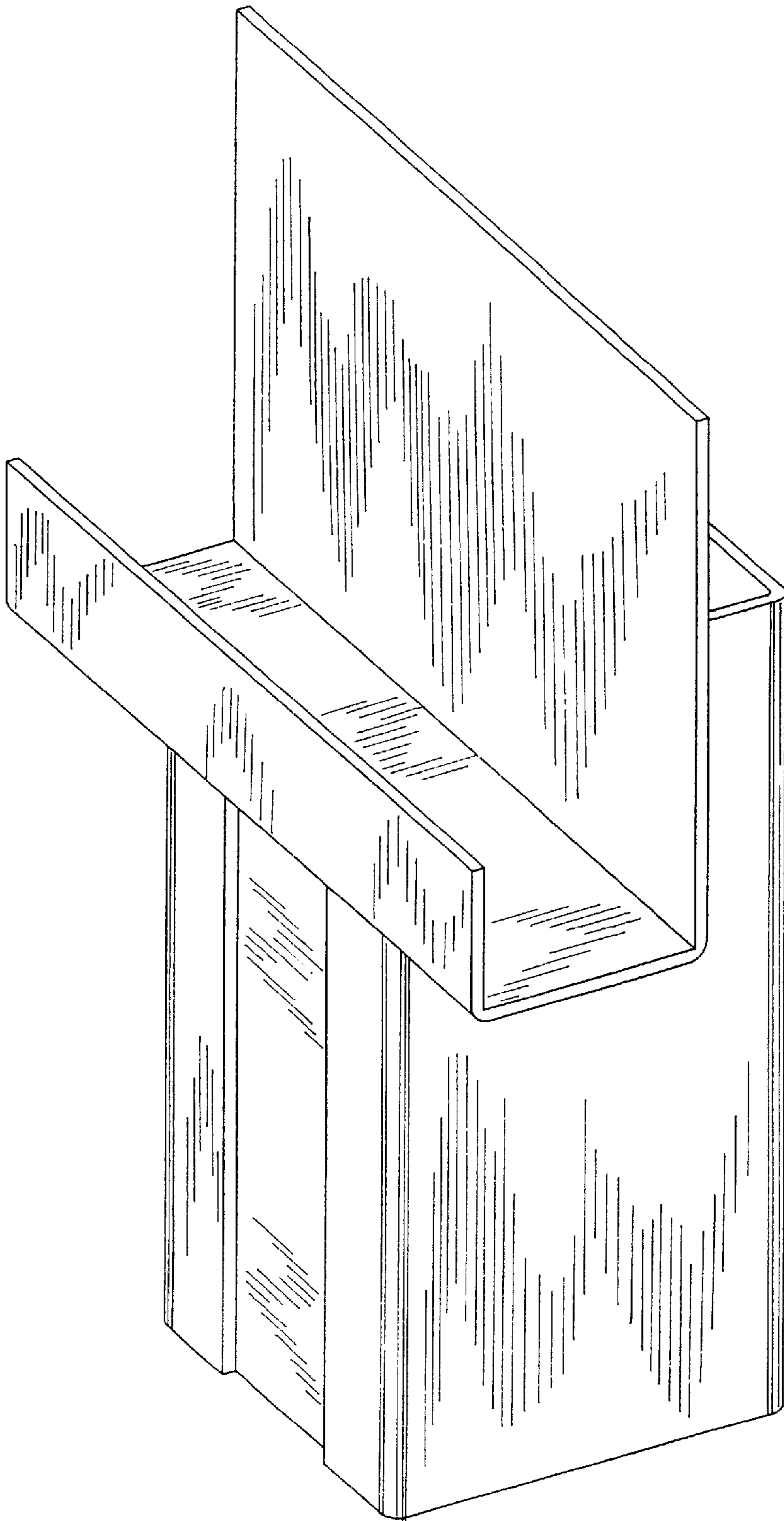

FIG. 7

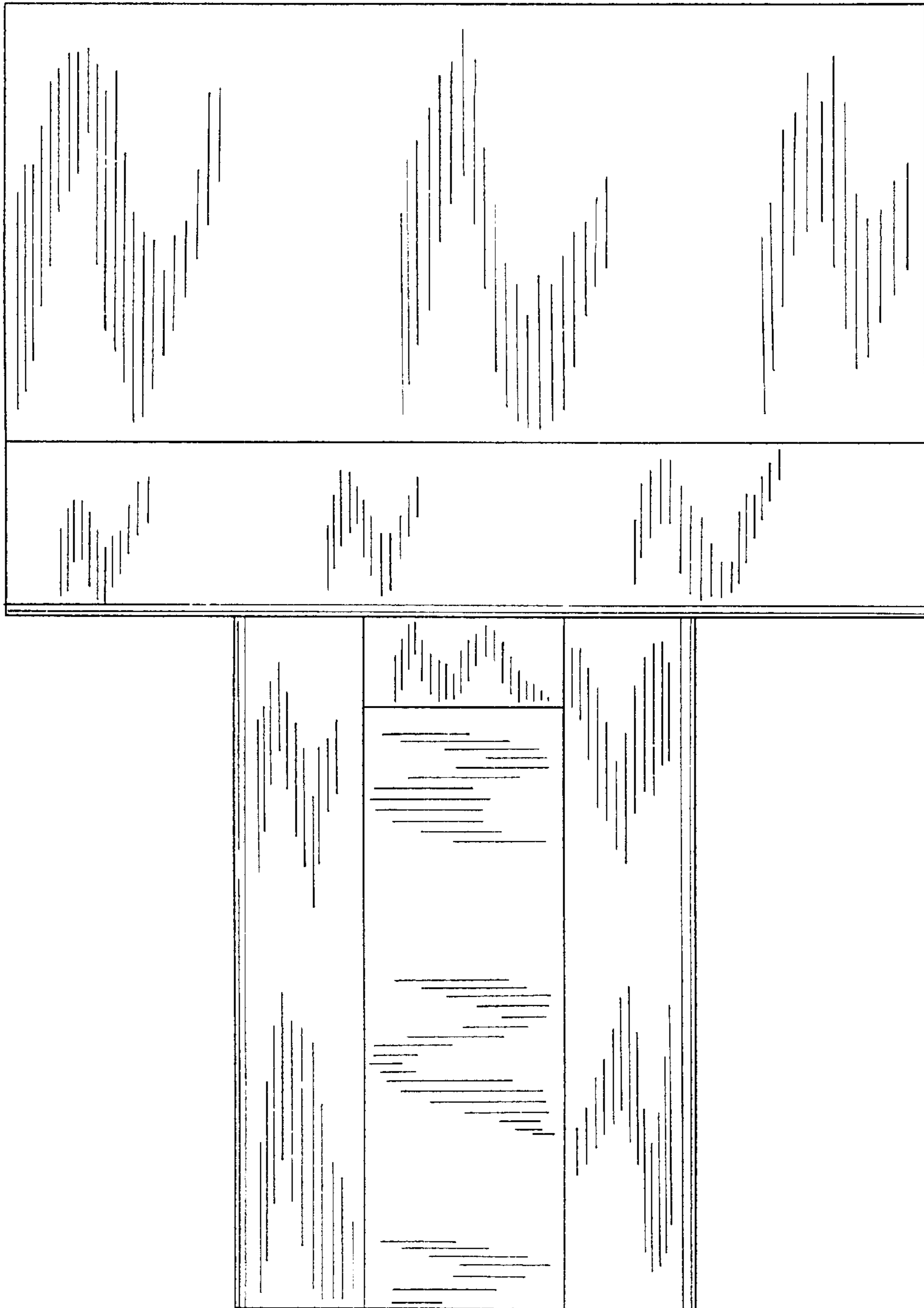

FIG. 8

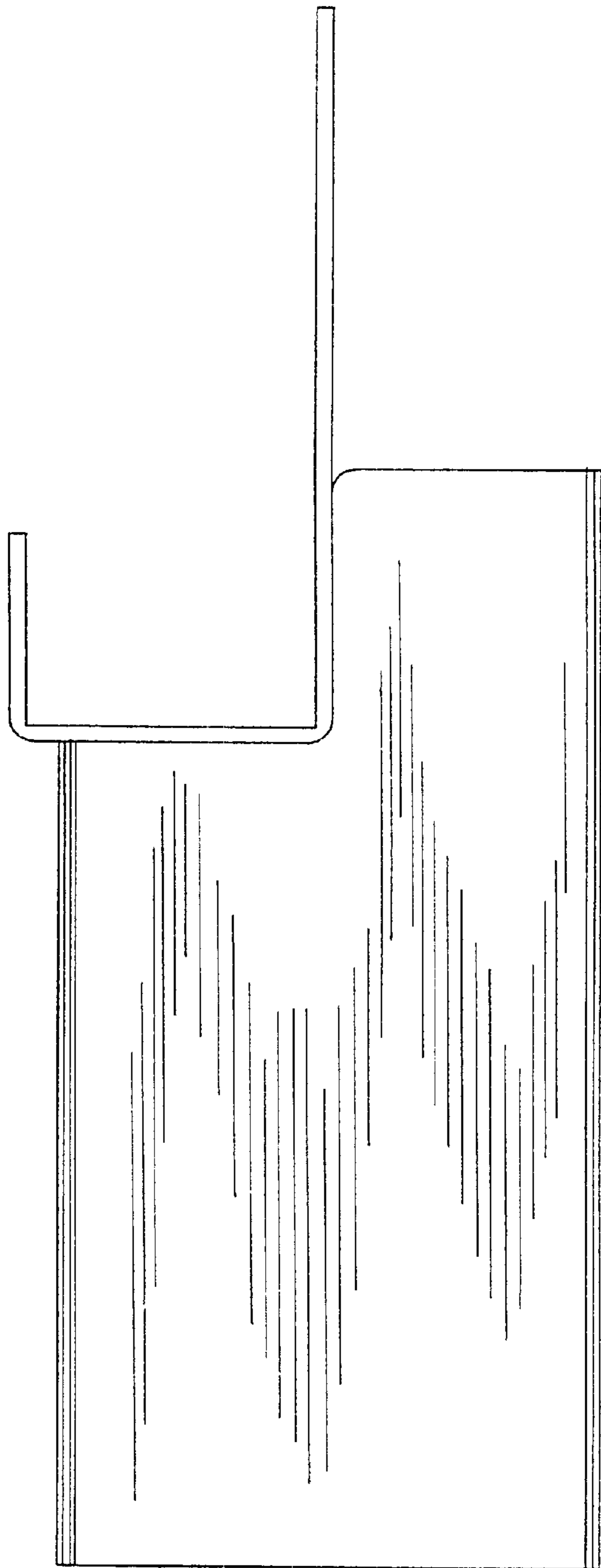

FIG. 9

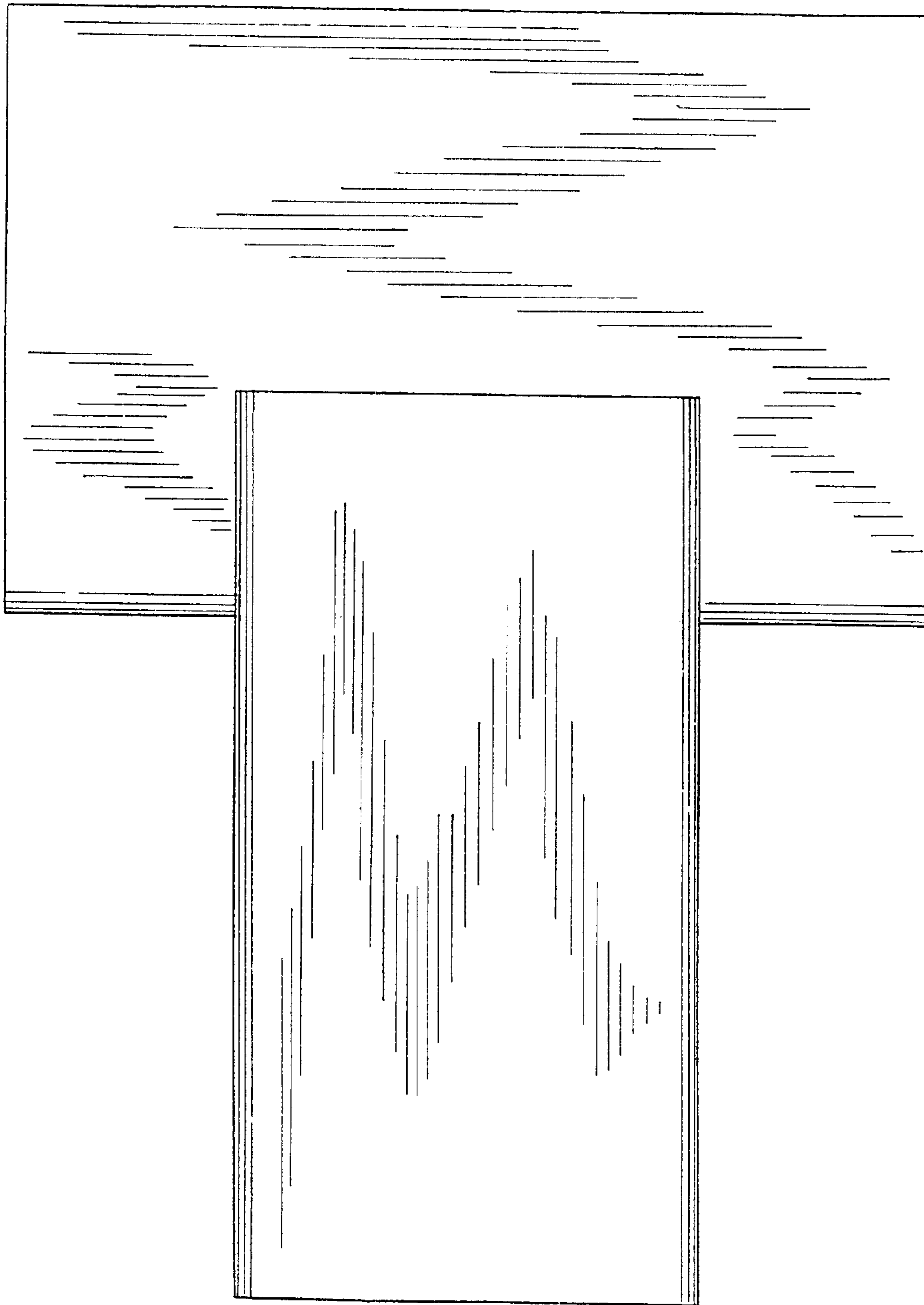

FIG. 10

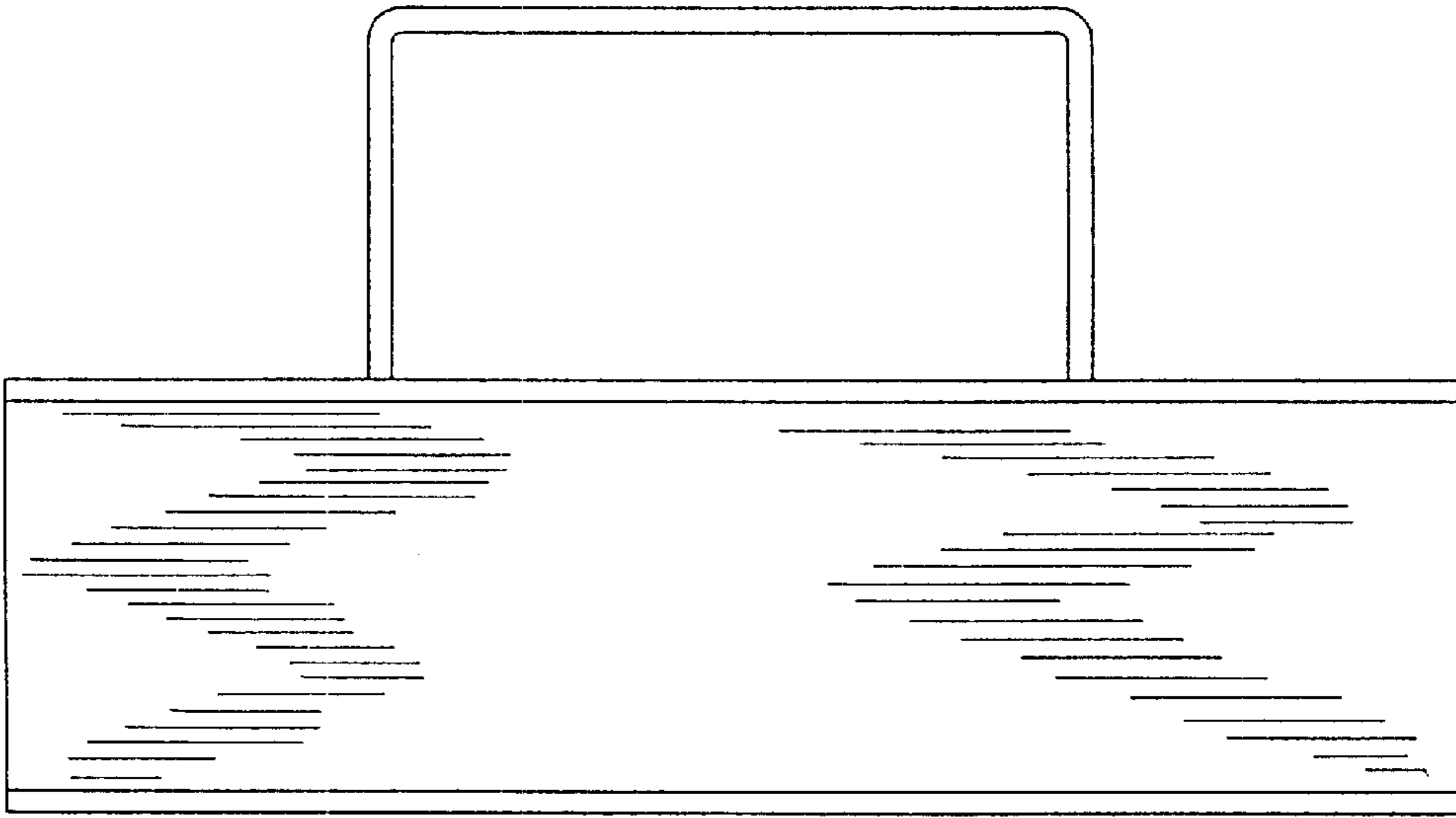

FIG. 11

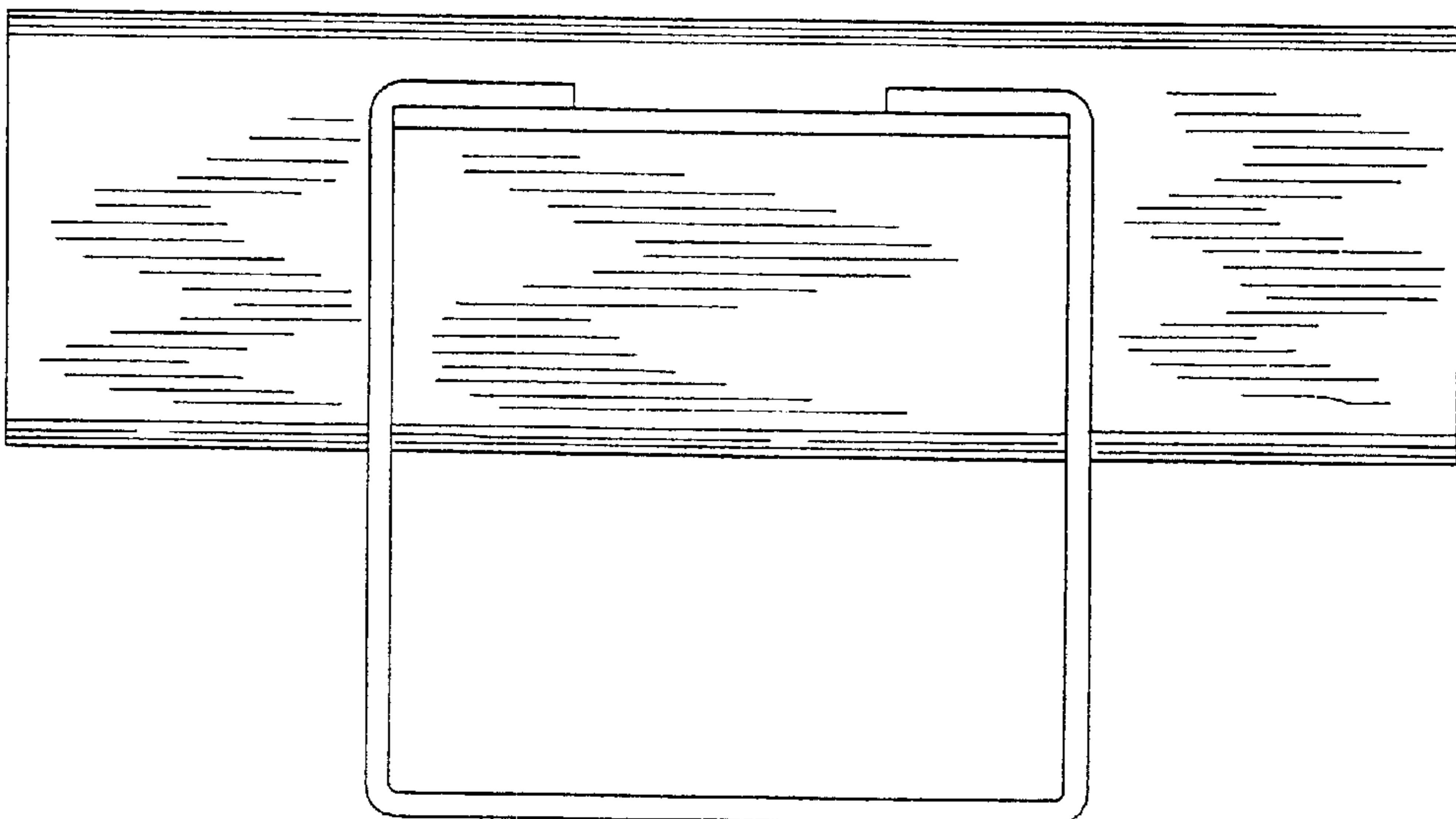

FIG. 12

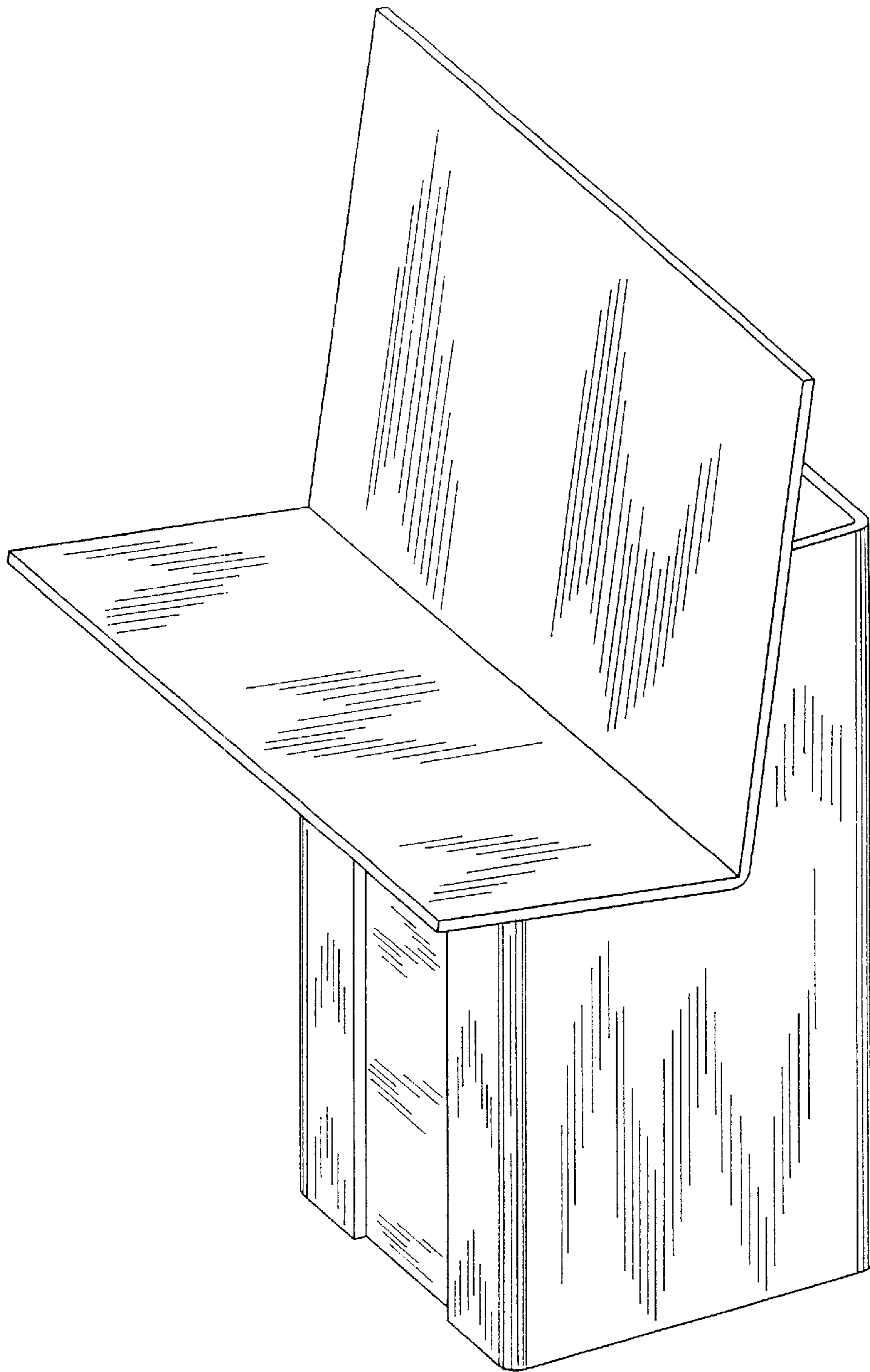

FIG. 13

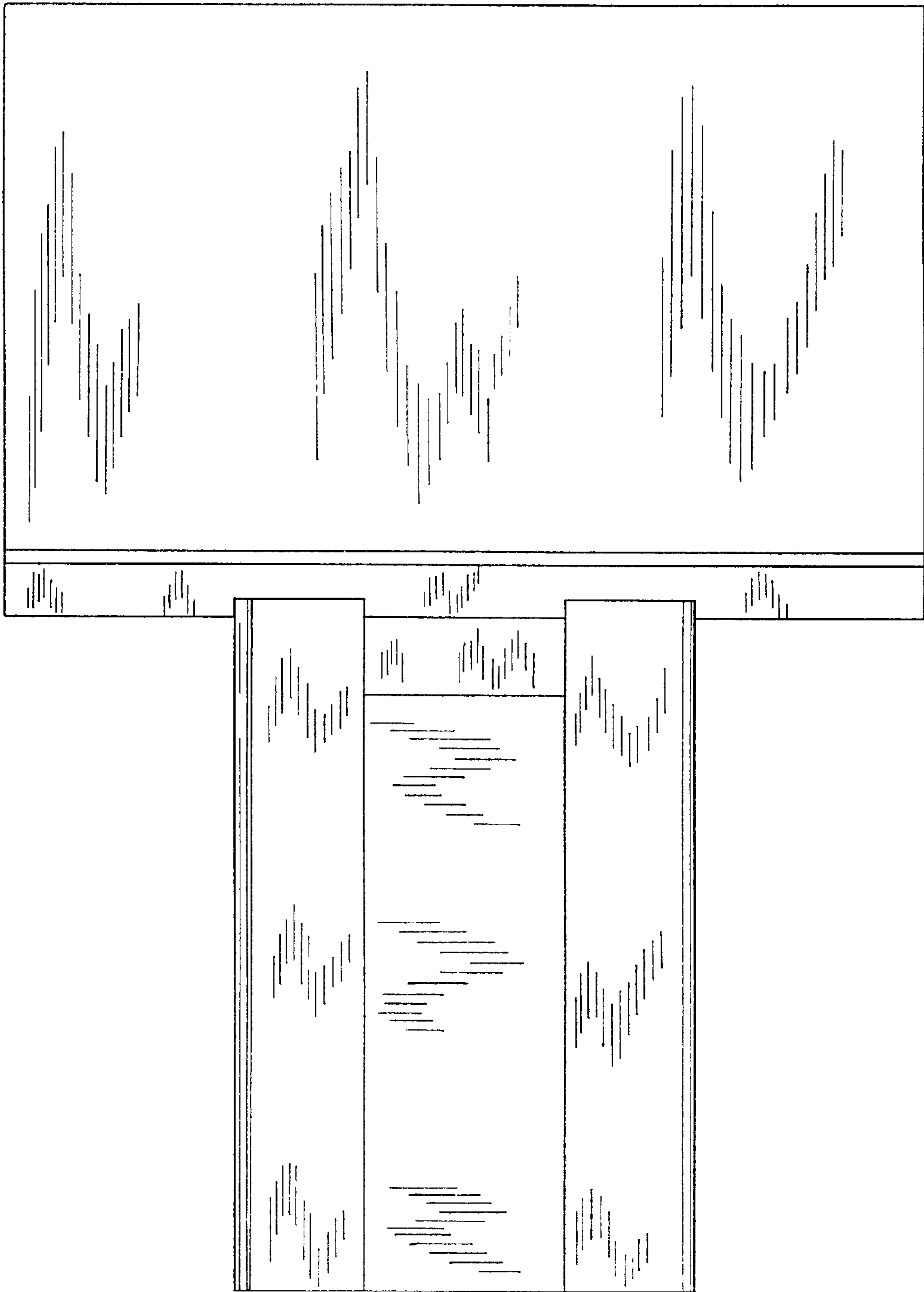

FIG. 14

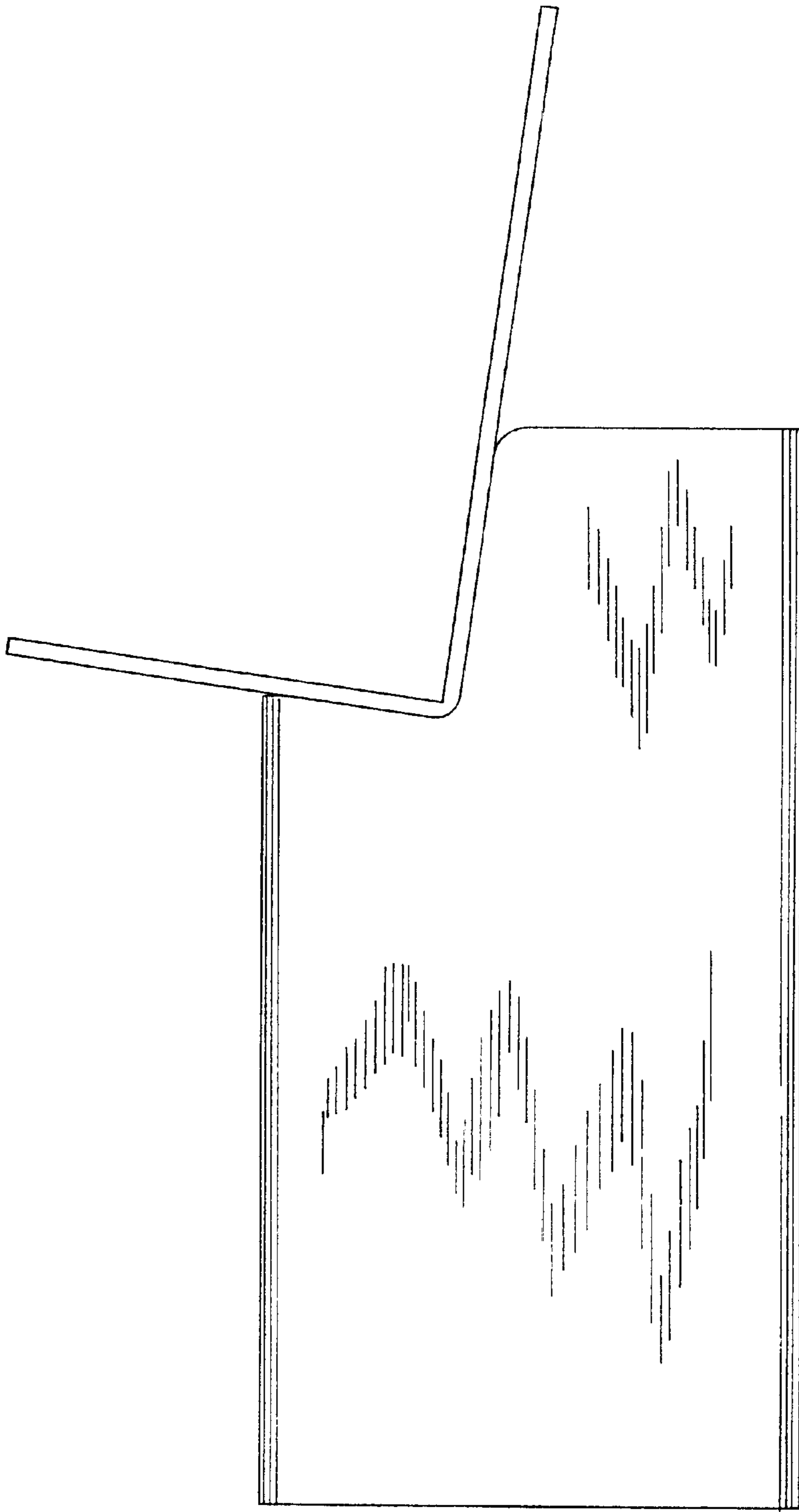

FIG. 15

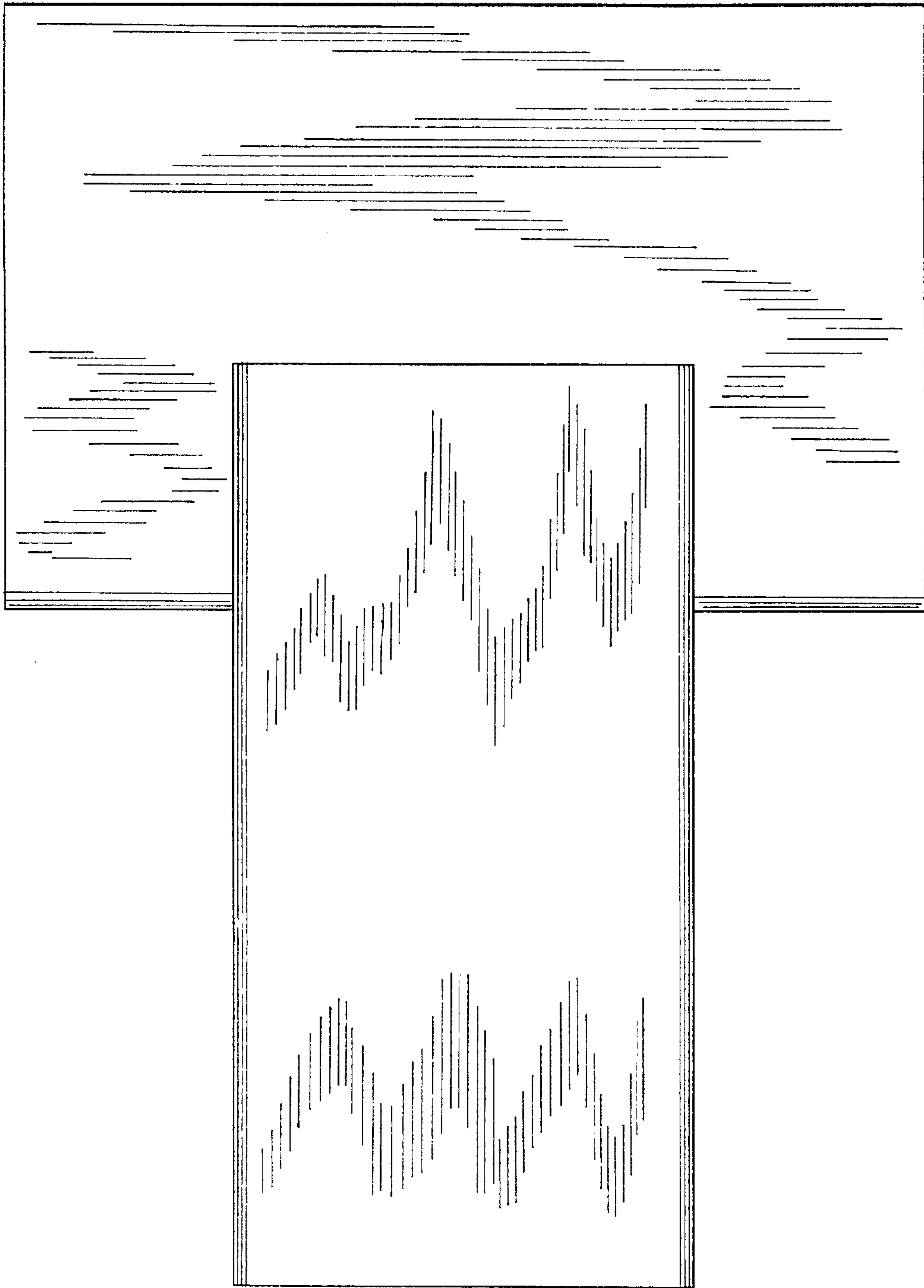

FIG. 16

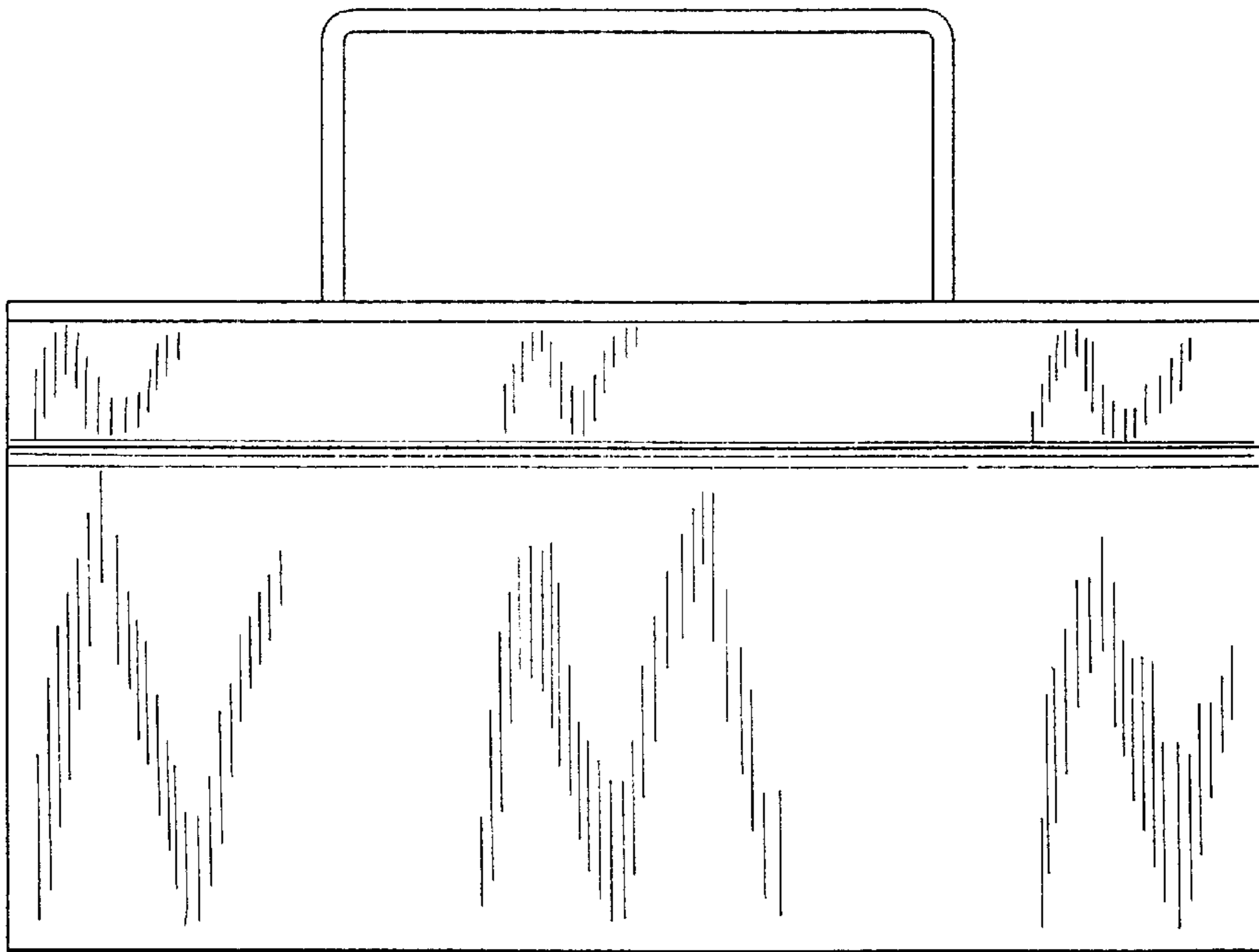

FIG. 17

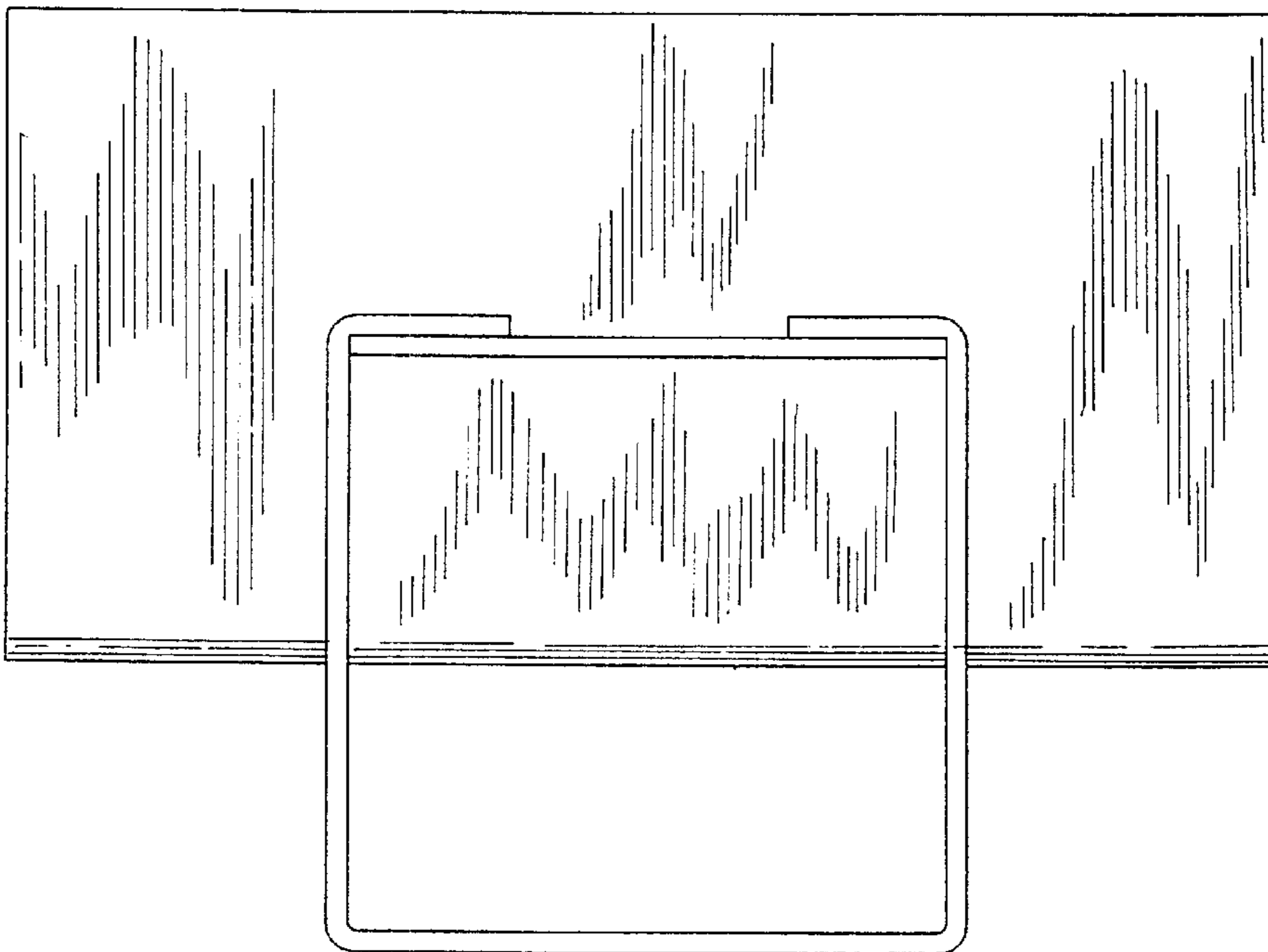

FIG. 18

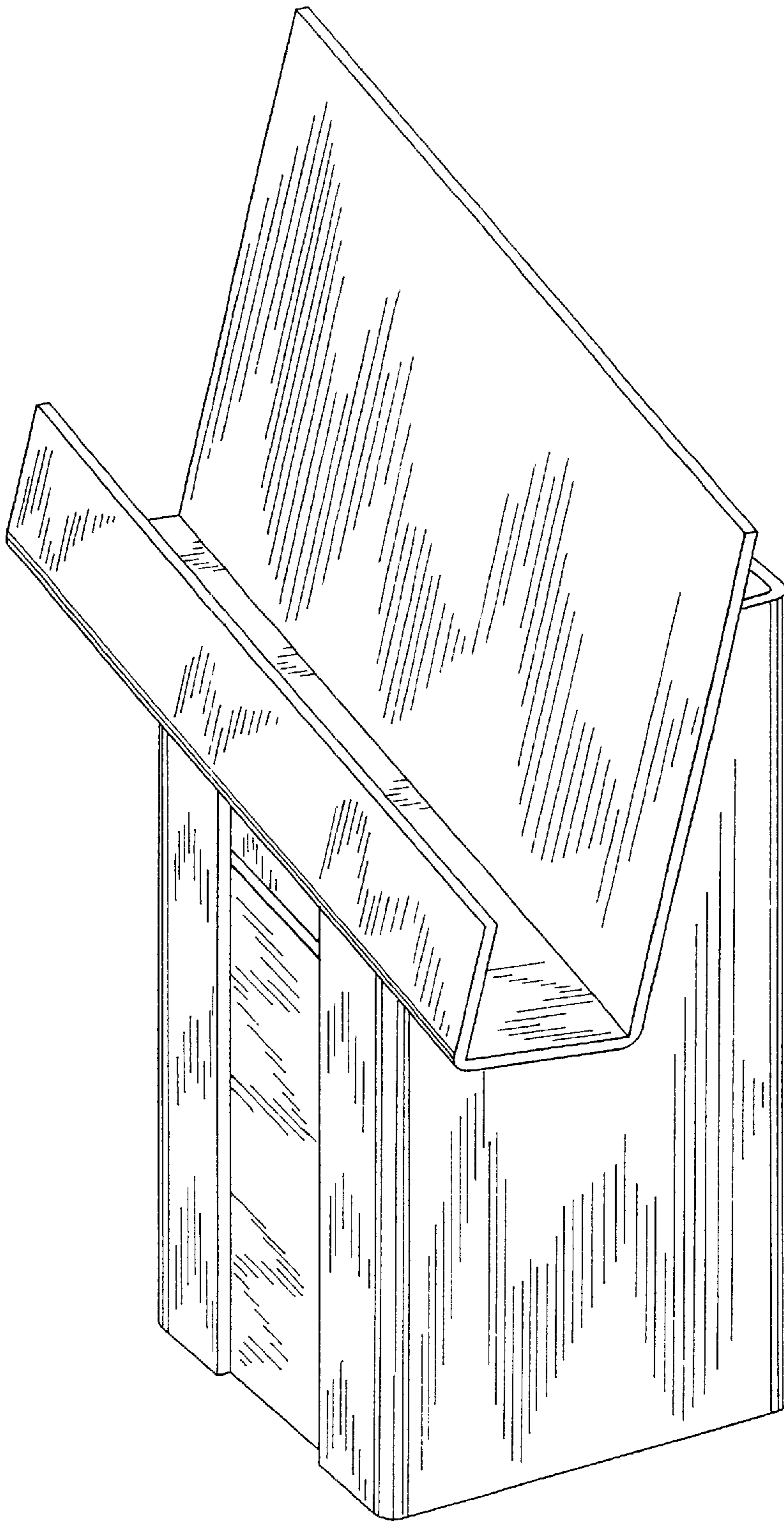

FIG. 19

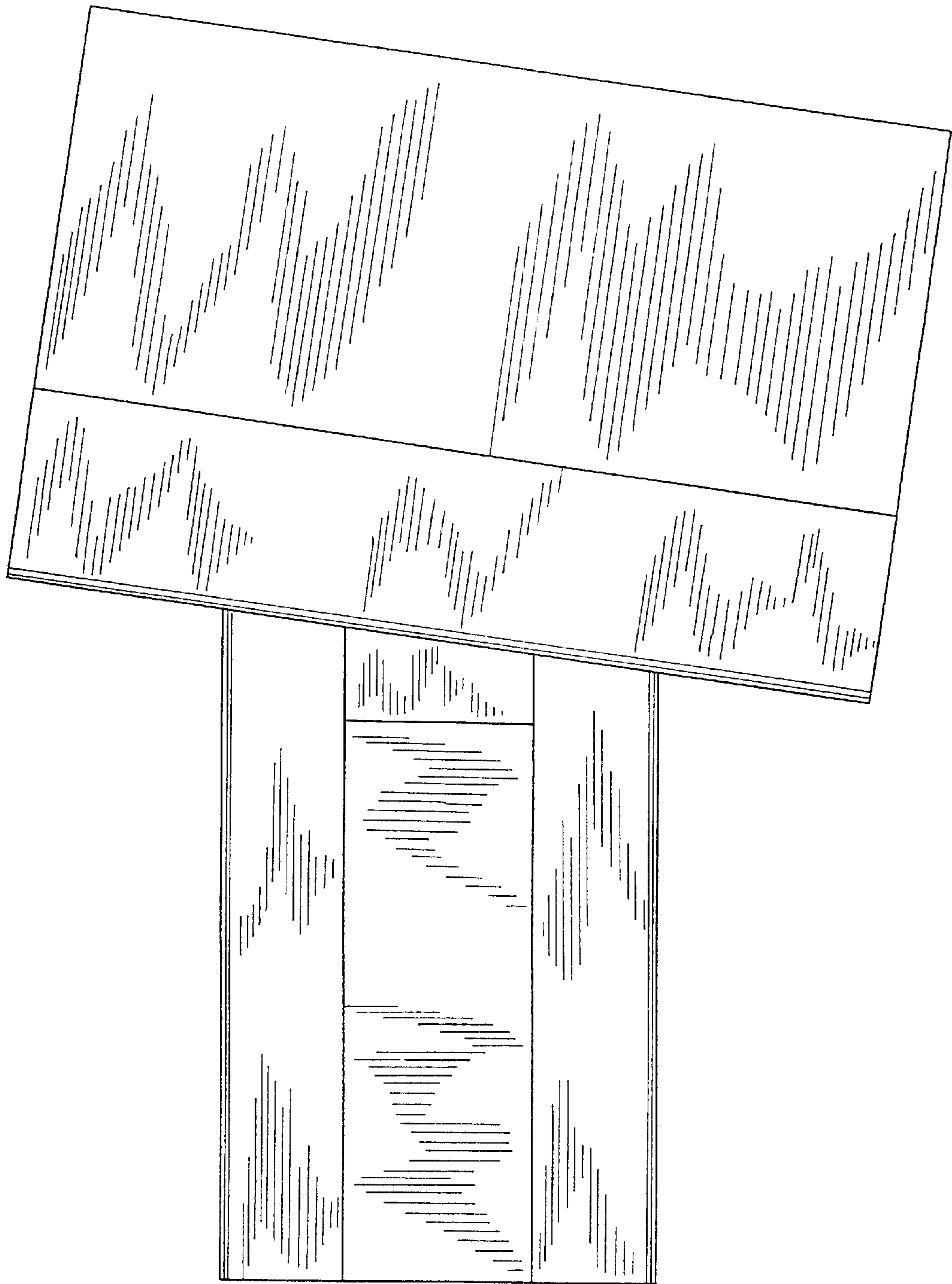

FIG. 20

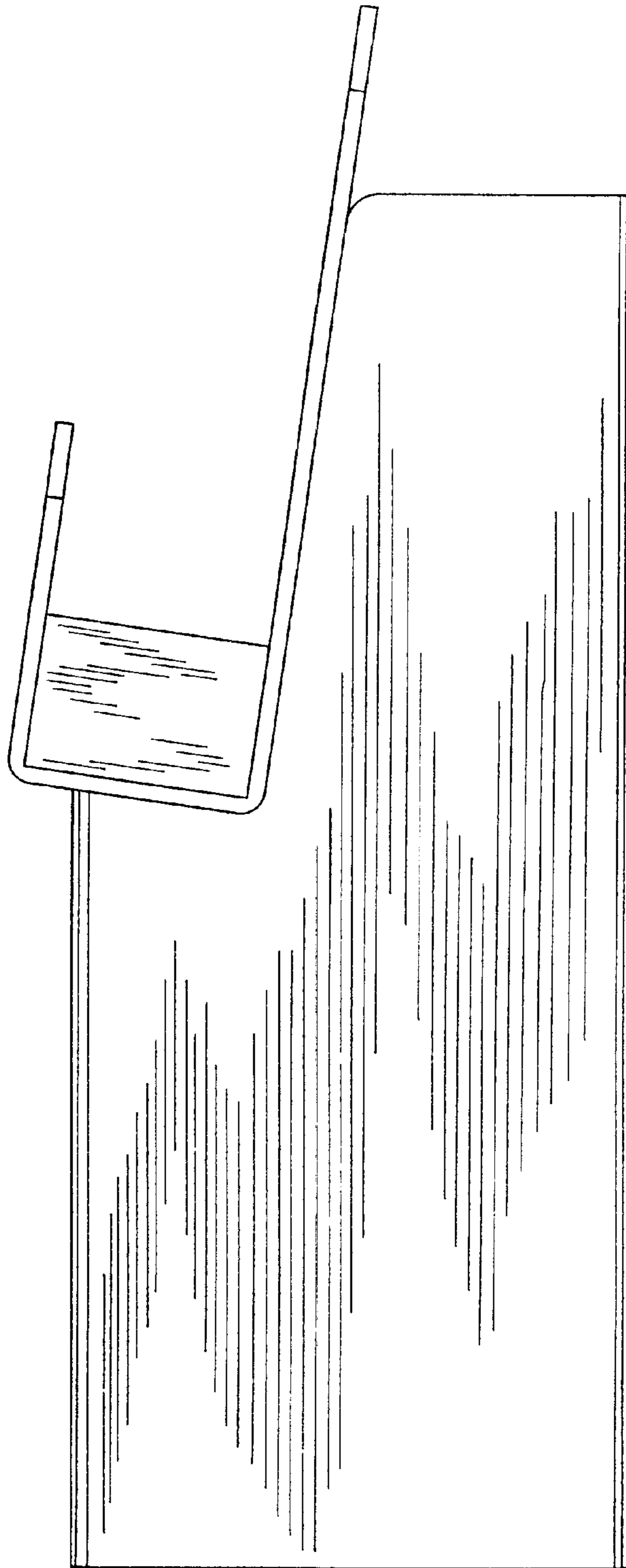

FIG. 21

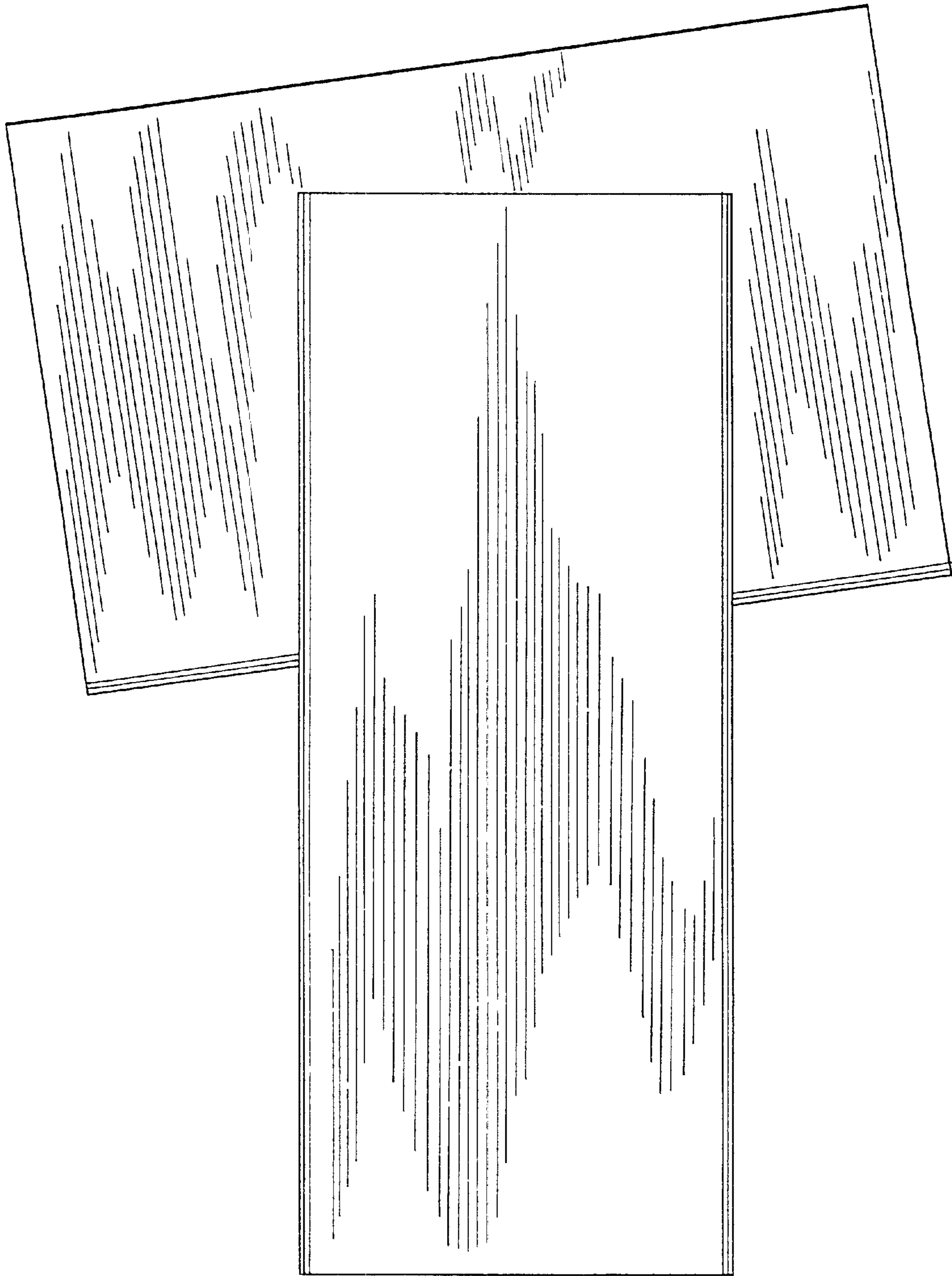

FIG. 22

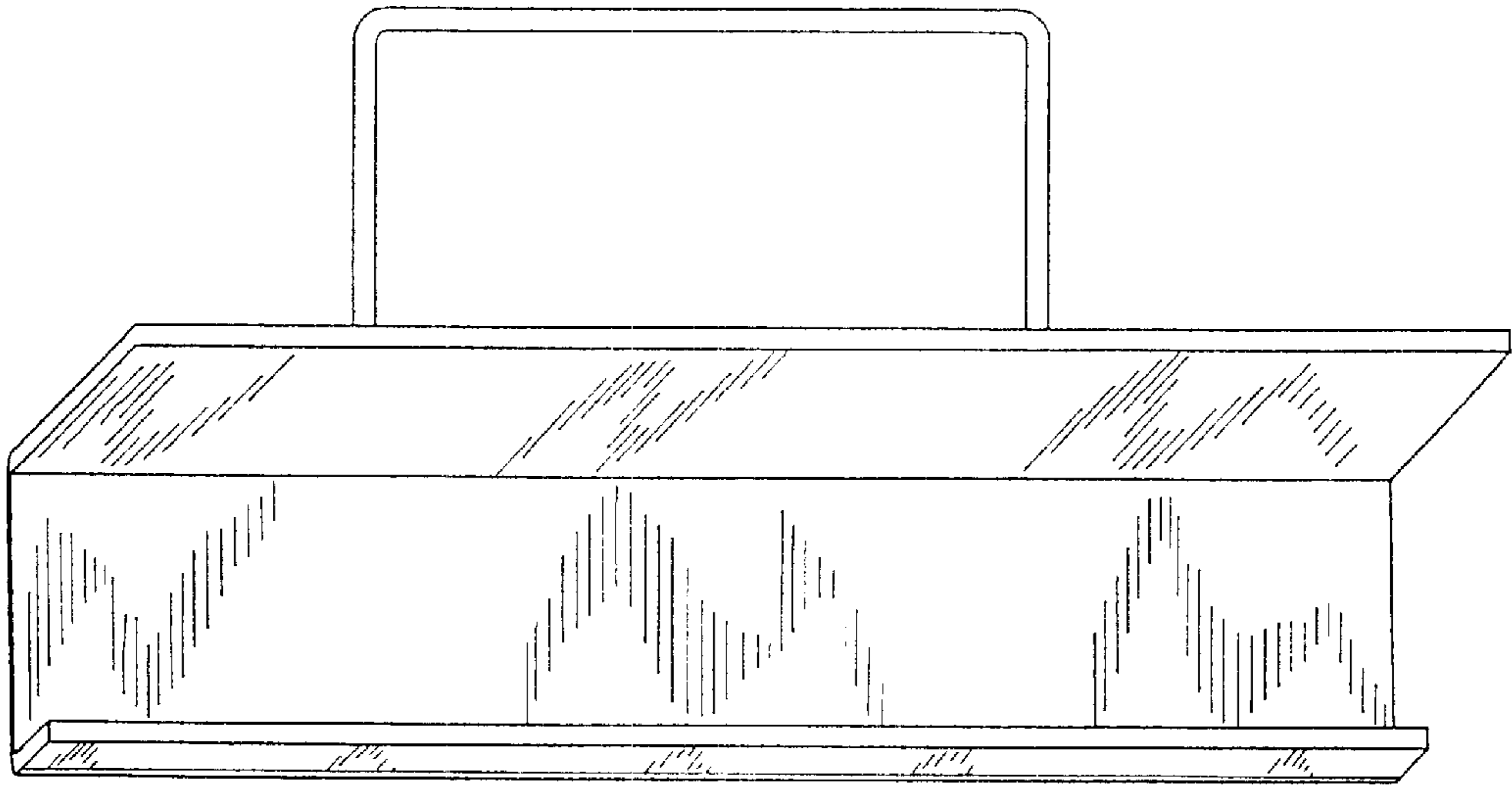

FIG. 23

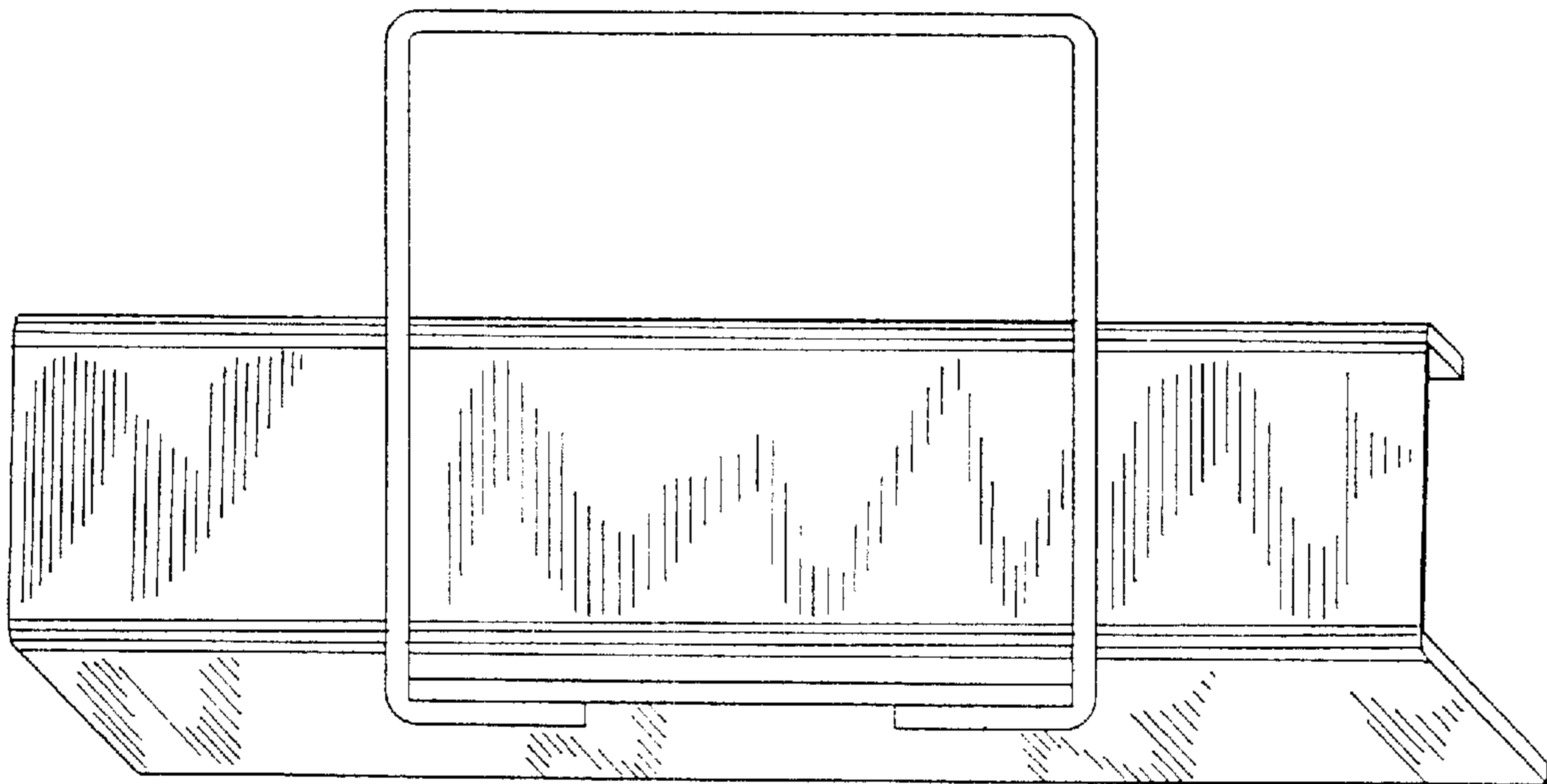

FIG. 24