



US00D474669S

(12) **United States Design Patent**
Onion

(10) **Patent No.:** **US D474,669 S**

(45) **Date of Patent:** **** May 20, 2003**

(54) **POCKET KNIFE**

FOREIGN PATENT DOCUMENTS

(76) Inventor: **Kenneth J. Onion**, Dept. BL8, 91-990
Oaniani St., Kapolei, HI (US) 96707

FR 1069862 7/1954

(**) Term: **14 Years**

OTHER PUBLICATIONS

(21) Appl. No.: **29/143,656**

Advertisements from the Aug., 1999 issue of *Blade* (pp. 8, 9, 15, 18, 20, 34, 73, 79, 116, 129, 137, 140 and 145-146).

(22) Filed: **Jun. 18, 2001**

* cited by examiner

(51) **LOC (7) Cl.** **08-03**

Primary Examiner—Philip S. Hyder

(52) **U.S. Cl.** **D8/99**

(74) *Attorney, Agent, or Firm*—Kolisch Hartwell, P.C.

(58) **Field of Search** D8/98, 99, 100;
30/151, 152, 153, 154, 155, 156, 157, 158,
159, 160

(57) **CLAIM**

The ornamental design for a pocket knife, as shown and described.

(56) **References Cited**

DESCRIPTION

U.S. PATENT DOCUMENTS

| | | | |
|-------------|-----------|-----------------|--------|
| 4,741,106 A | 5/1988 | Yamagishi | 30/161 |
| 5,060,379 A | 10/1991 | Neely | 30/161 |
| D333,251 S | 2/1993 | Glessner | D8/99 |
| D345,289 S | 3/1994 | Sakai | D8/99 |
| D347,375 S | 5/1994 | Sakai | D8/99 |
| 5,400,509 A | 3/1995 | Collins | 30/161 |
| 5,437,101 A | 8/1995 | Collins | 30/153 |
| D366,408 S | 1/1996 | Sessions et al. | D8/99 |
| D373,716 S | 9/1996 | Keys et al. | D8/99 |
| 5,581,895 A | 12/1996 | Jeffcoat | 30/294 |
| D377,744 S | 2/1997 | Hasegawa | D8/99 |
| D384,871 S | 10/1997 | McWillis | D8/99 |
| D389,718 S | * 1/1998 | Wegner | D8/99 |
| D392,538 S | 3/1998 | Buck et al. | D8/99 |
| D392,539 S | 3/1998 | Balolia | D8/99 |
| 5,802,722 A | 9/1998 | Maxey et al. | 30/160 |
| D399,113 S | 10/1998 | Balolia | D8/99 |
| 5,815,927 A | 10/1998 | Collins | 30/161 |
| 5,845,404 A | 12/1998 | Jeffcoat | 30/125 |
| D407,003 S | * 3/1999 | Macowski et al. | D8/99 |
| D422,479 S | * 4/2000 | Pardue | D8/99 |
| 6,145,202 A | 11/2000 | Onion | 30/160 |
| D434,631 S | * 12/2000 | Lum | D8/99 |
| D438,085 S | 2/2001 | Onion | D8/99 |

FIG. 1 is a front view of an embodiment of the pocket knife in closed form according to the present invention.

FIG. 2 is a rear view of the embodiment shown in FIG. 1.

FIG. 3 is a top view of the embodiment shown in FIG. 2.

FIG. 4 is a bottom view of the embodiment shown in FIG. 2.

FIG. 5 is a left end view of the embodiment shown in FIG. 2.

FIG. 6 is a right end view of the embodiment shown in FIG. 2.

FIG. 7 is a front view of an embodiment of the pocket knife in opened form according to the present invention.

FIG. 8 is a rear view of the embodiment shown in FIG. 7.

FIG. 9 is a top view of the embodiment shown in FIG. 8.

FIG. 10 is a bottom view of the embodiment shown in FIG. 8.

FIG. 11 is a left end view of the embodiment shown in FIG. 8; and,

FIG. 12 is a right end view of the embodiment shown in FIG. 8.

The broken line portions of the disclosure are for illustrative purposes only and form no part of the claimed design.

1 Claim, 3 Drawing Sheets

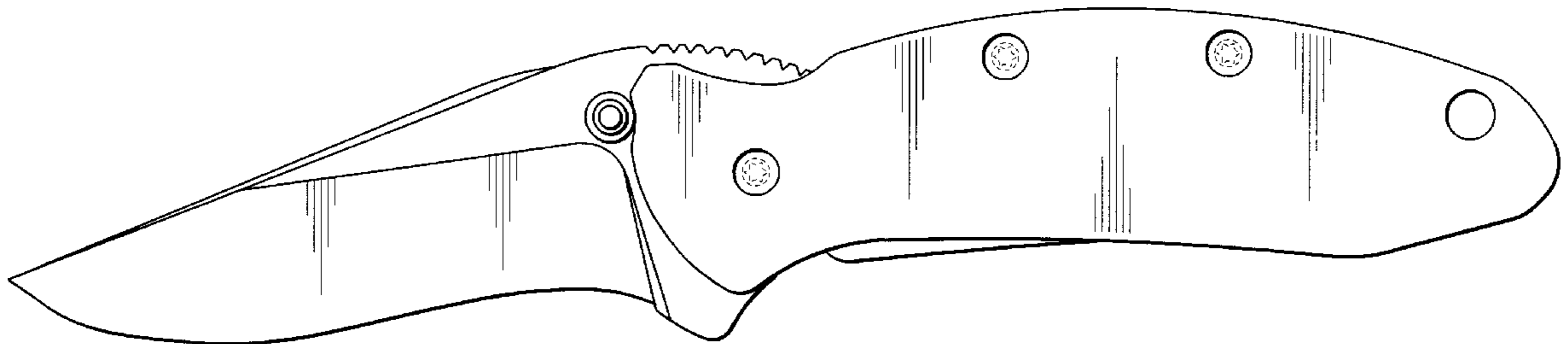

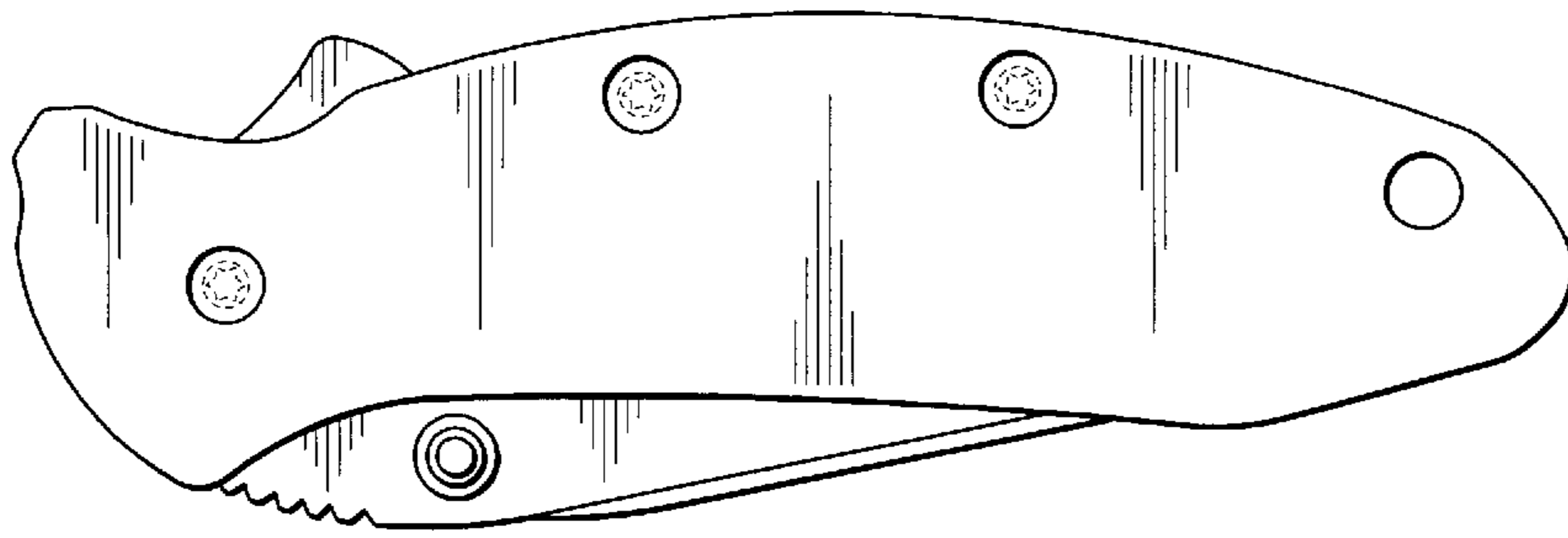

FIG. 1

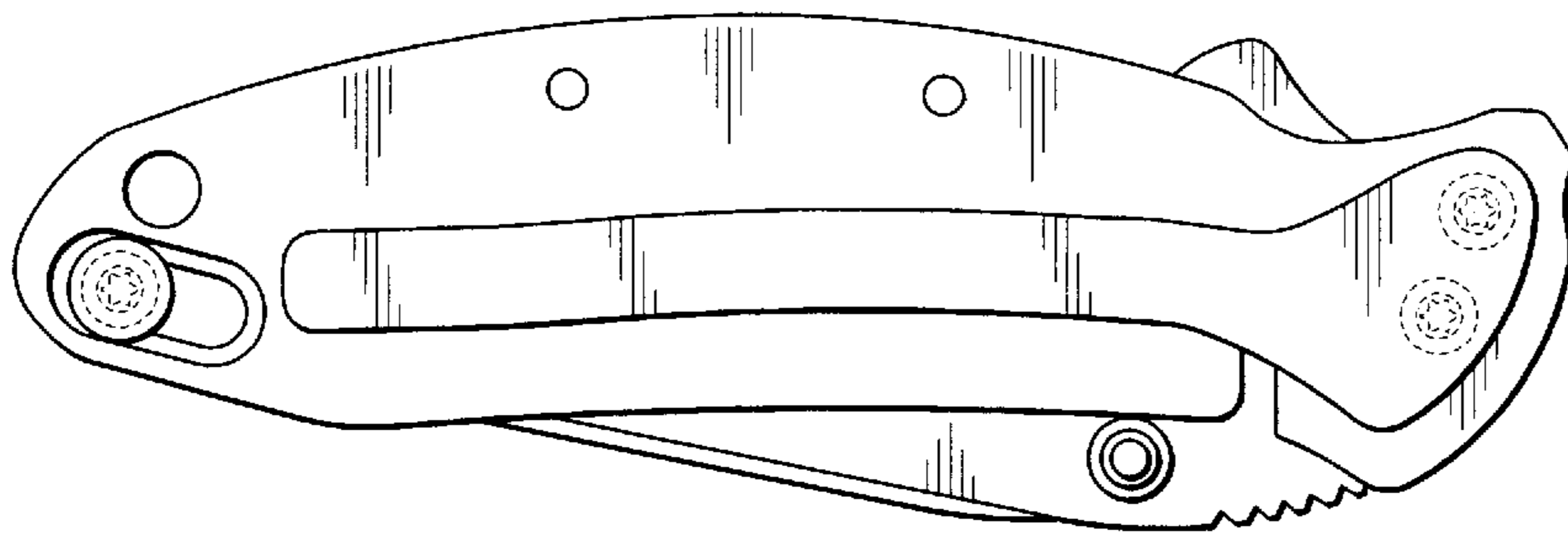

FIG. 2

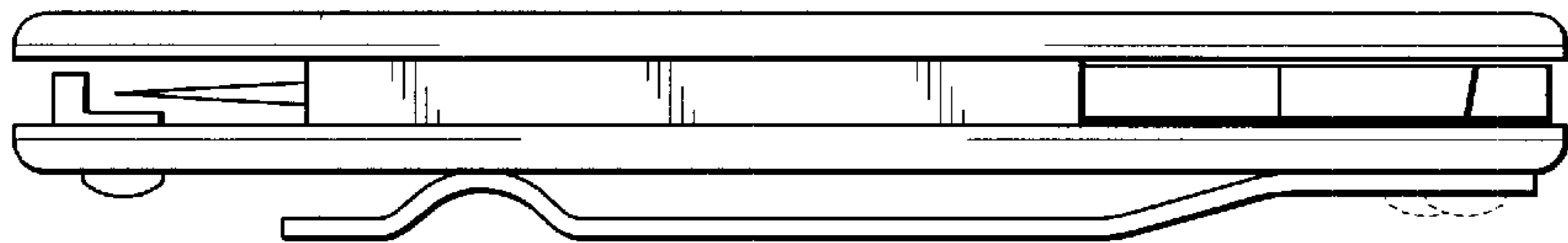

FIG. 3

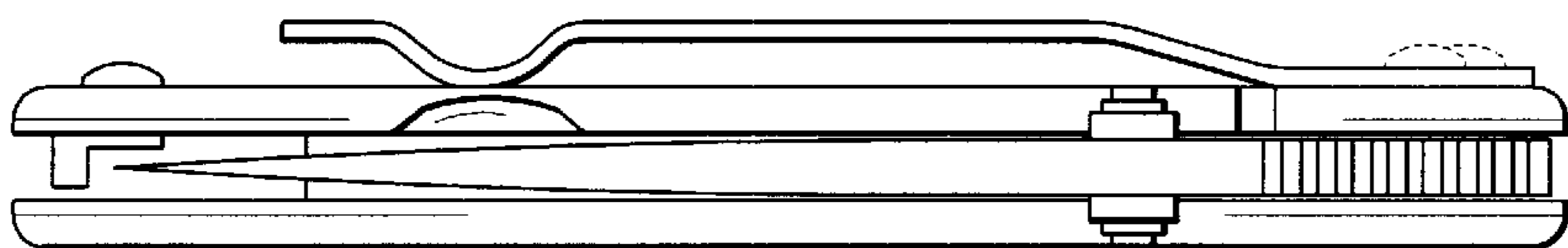

FIG. 4

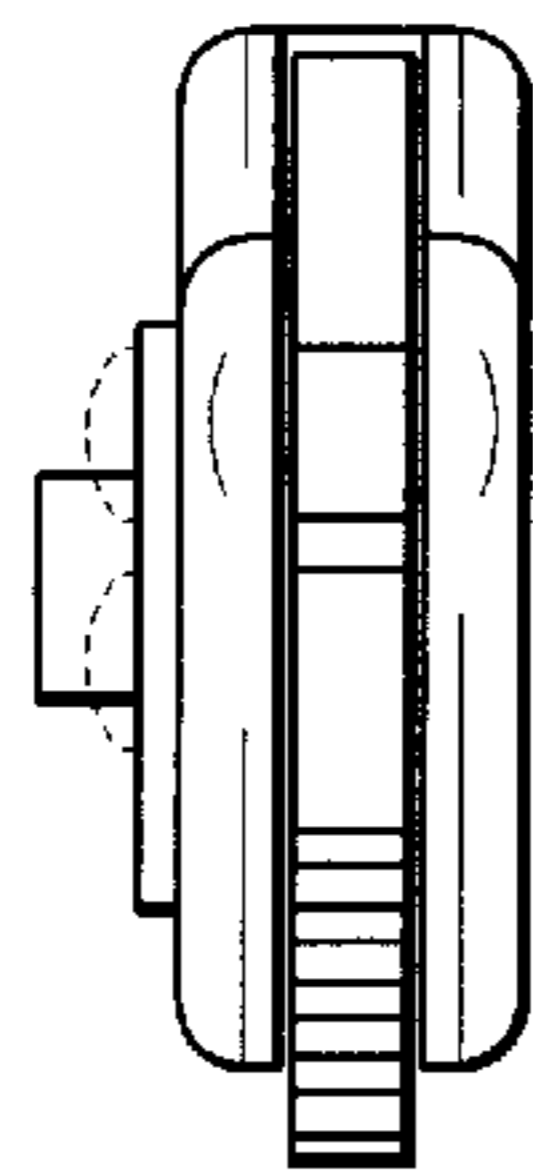

FIG. 5

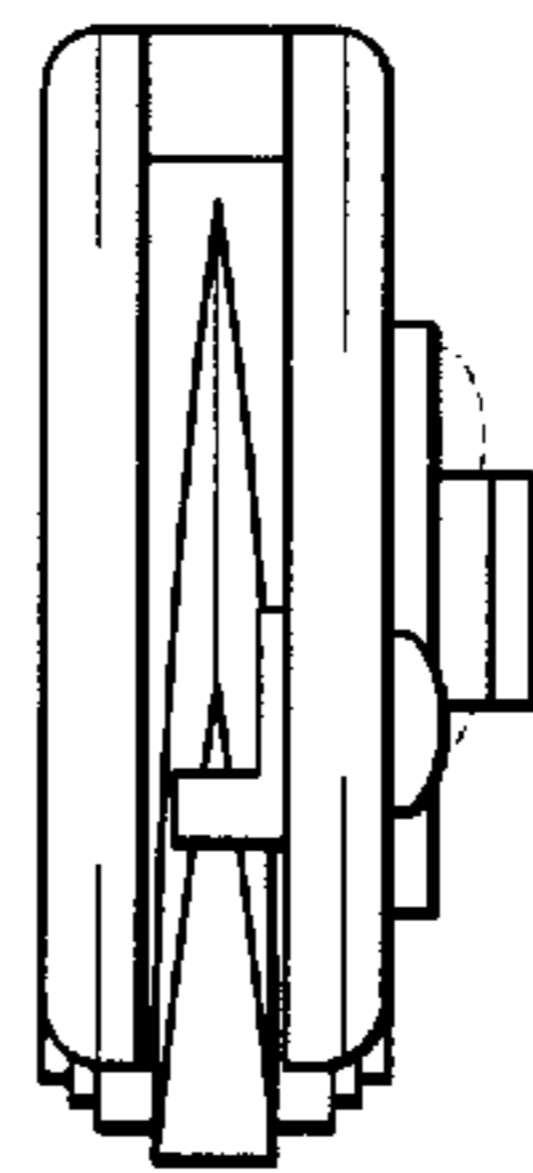
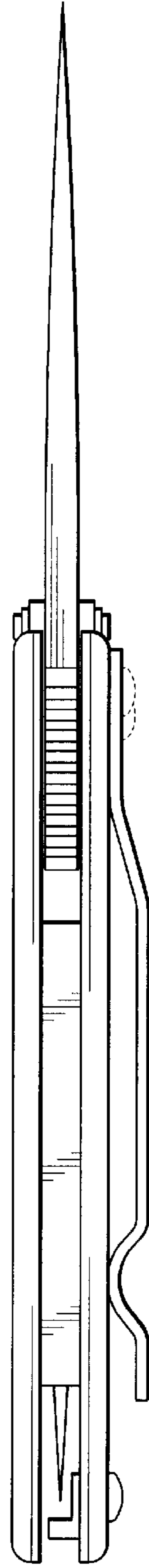
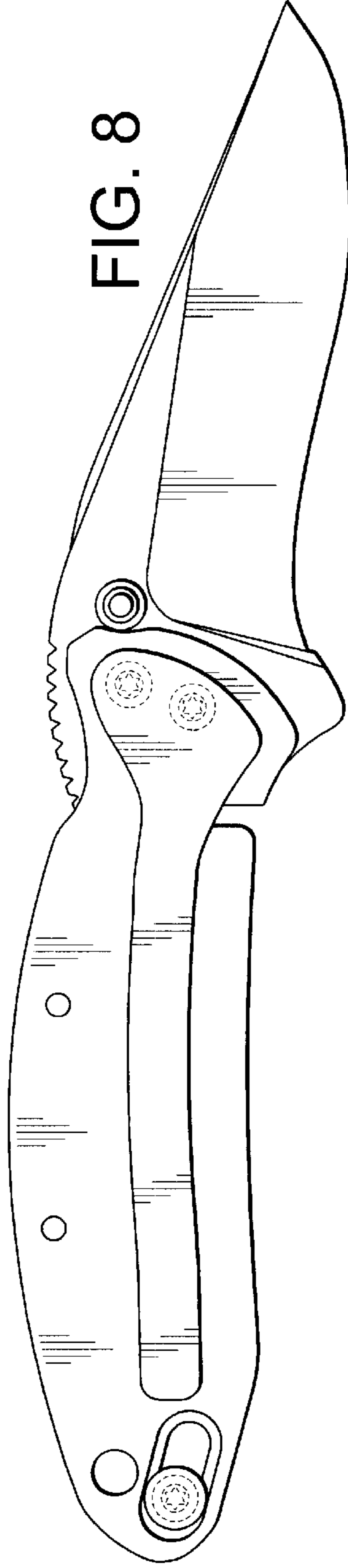
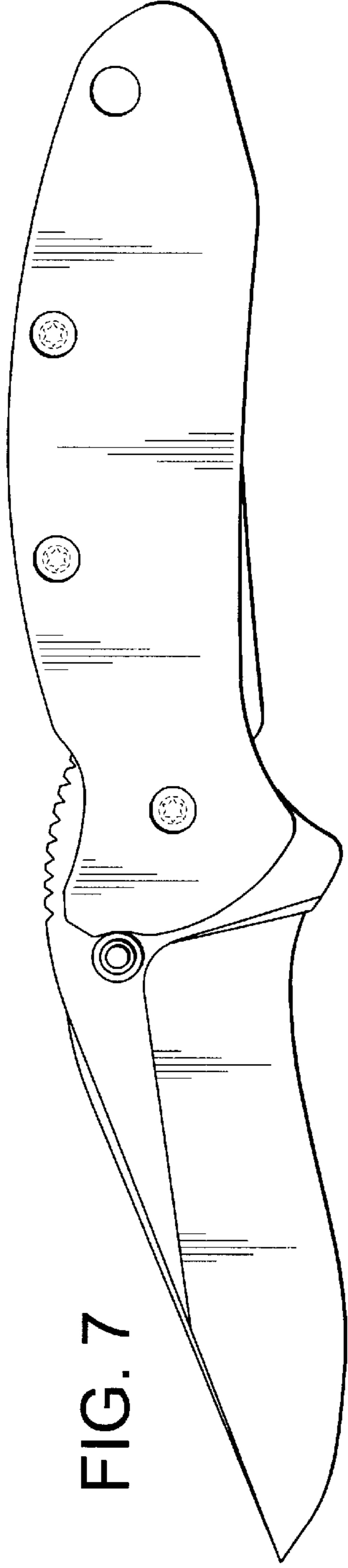

FIG. 6



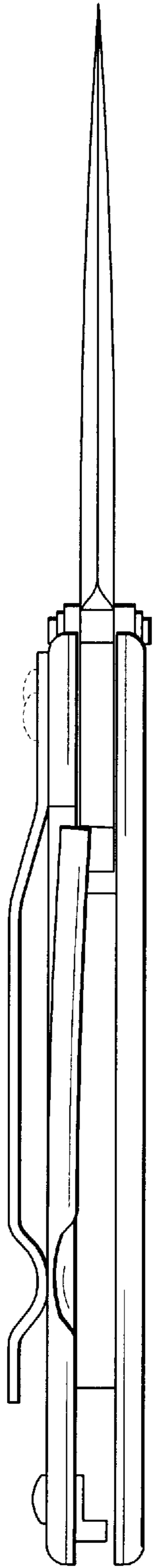

FIG. 10

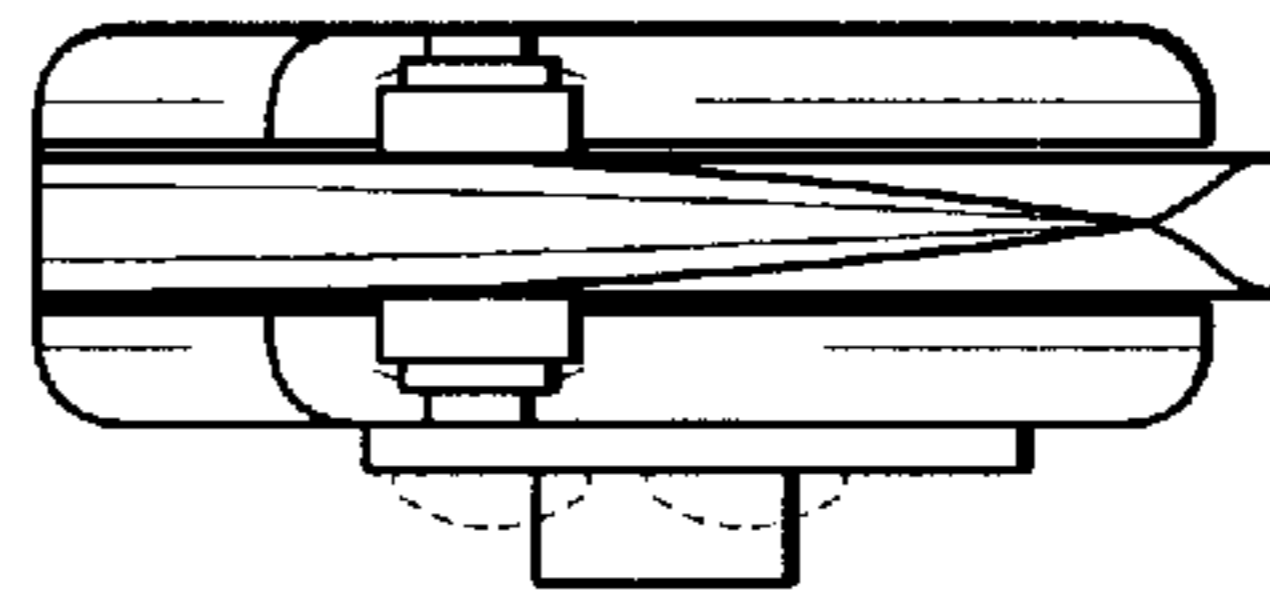

FIG. 11

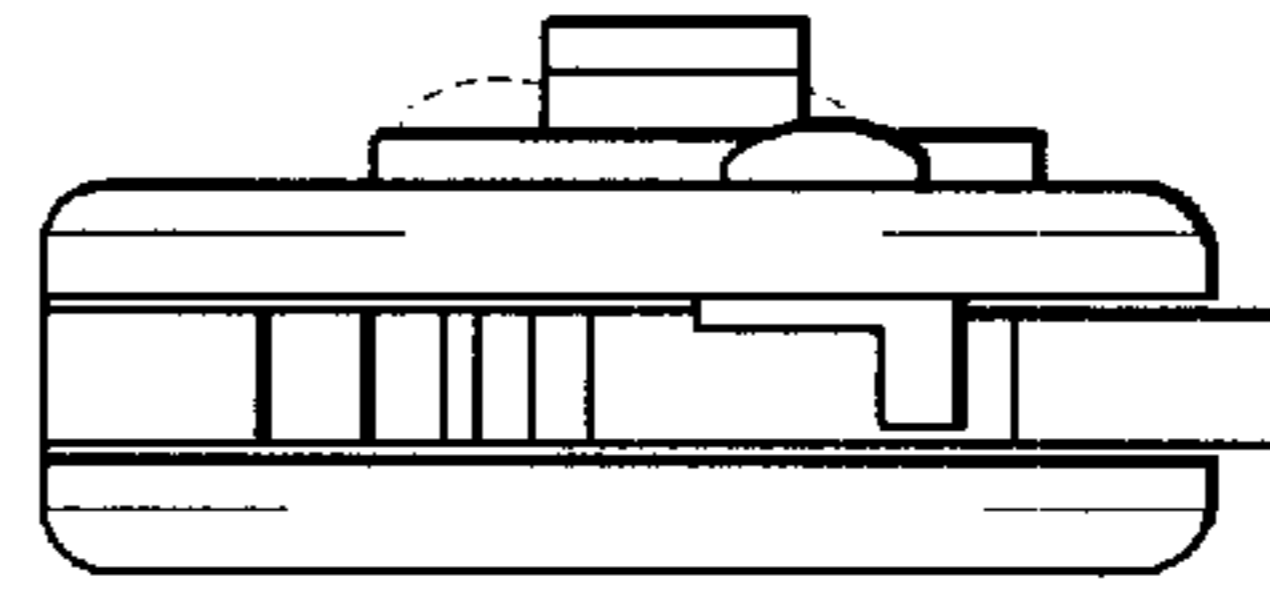

FIG. 12