



US00D474655S

(12) **United States Design Patent**
Schmidt

(10) **Patent No.:** **US D474,655 S**

(45) **Date of Patent:** **** May 20, 2003**

(54) **HANDLE FOR KNIFE**

DESCRIPTION

(75) Inventor: **George Schmidt**, Douglaston, NY (US)

(73) Assignee: **Excel Importing Corp.**, Hicksville, NY (US)

(**) Term: **14 Years**

(21) Appl. No.: **29/168,492**

(22) Filed: **Oct. 3, 2002**

(51) **LOC (7) Cl.** **07-03**

(52) **U.S. Cl.** **D7/649; D7/401.2**

(58) **Field of Search** **D7/642, 645, 649, D7/650, 652, 401.2; D22/118; 30/329, 340, 342-345**

(56) **References Cited**

U.S. PATENT DOCUMENTS

D333,239 S * 2/1993 Pogue D7/649
D365,725 S * 1/1996 Hasegawa D7/401.2

* cited by examiner

Primary Examiner—Caron D. Veynar

(74) *Attorney, Agent, or Firm*—Cohen, Pontani, Lieberman & Pavane

(57) **CLAIM**

The ornamental design for a handle for knife, as shown and described.

FIG. 1 is a side elevation view of a handle for knife showing my new design, the opposite side view is a mirror image; FIG. 2 is a top plan view thereof; FIG. 3 is a rear elevational view thereof; FIG. 4 is a front elevational view thereof; FIG. 5 is a bottom plan view thereof; FIG. 6 is a cross-sectional view taken along line 6—6 in FIG. 1; FIG. 7 is a cross-sectional view taken along line 7—7 in FIG. 1; FIG. 8 is a cross-sectional view taken along line 8—8 in FIG. 1; FIG. 9 is a side elevation view of a second embodiment of the handle for knife, the opposite side view is a mirror image; FIG. 10 is a top plan view thereof; FIG. 11 is a rear elevational view thereof; FIG. 12 is a front elevational view thereof; FIG. 13 is a bottom plan view thereof; FIG. 14 is a side elevation view of a third embodiment of the handle for knife, the opposite side view is a mirror image; FIG. 15 is a top plan view thereof; FIG. 16 is a rear elevational view thereof; FIG. 17 is a front elevational view thereof; and, FIG. 18 is a bottom plan view thereof. The broken line showing of a knife blade in FIGS. 1, 2, 4, 5, 9, 10, 12, 13, 14, 15, 17, and 18 are for illustrative purposes only and form no part of the claimed design.

1 Claim, 6 Drawing Sheets

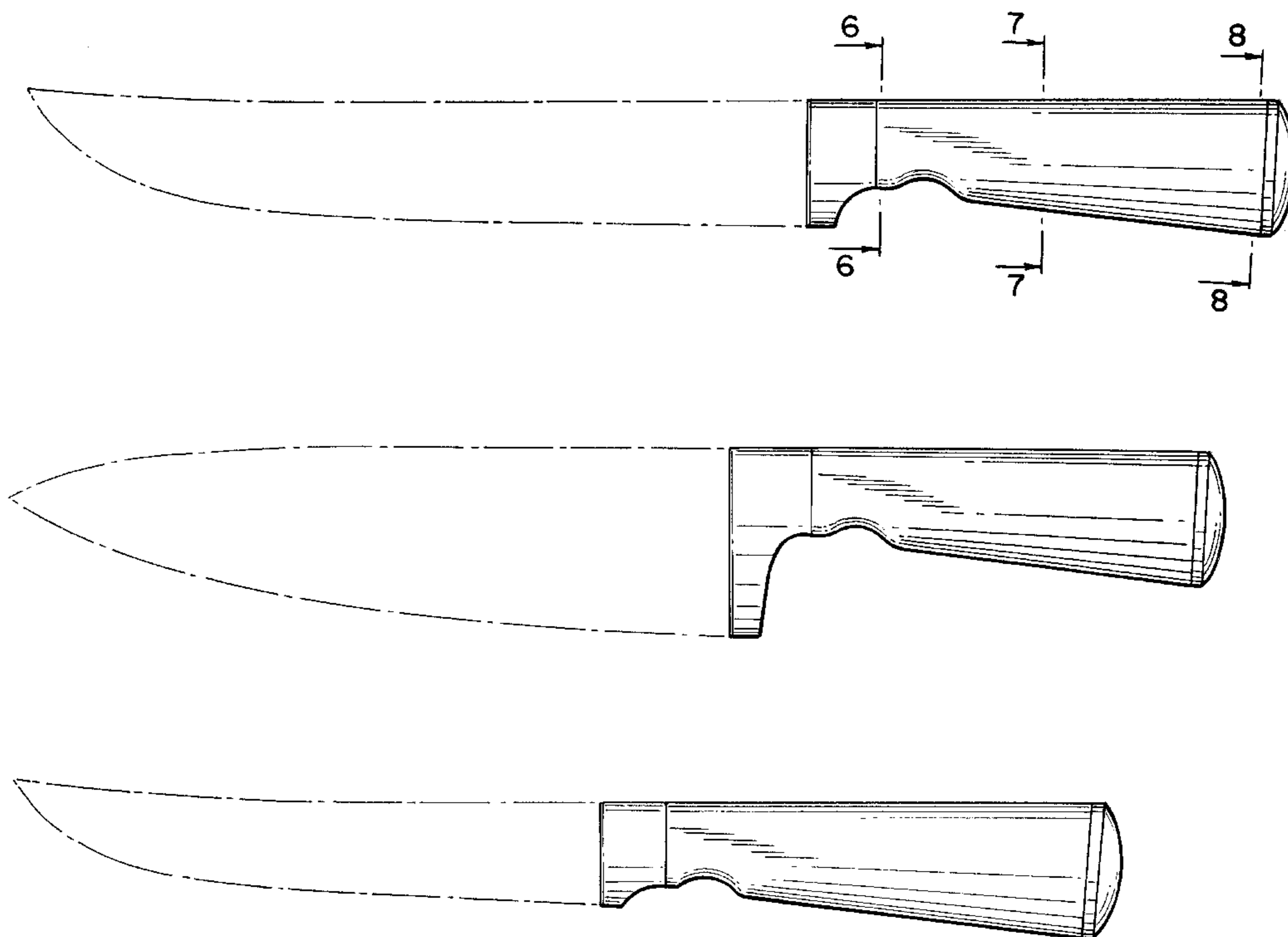

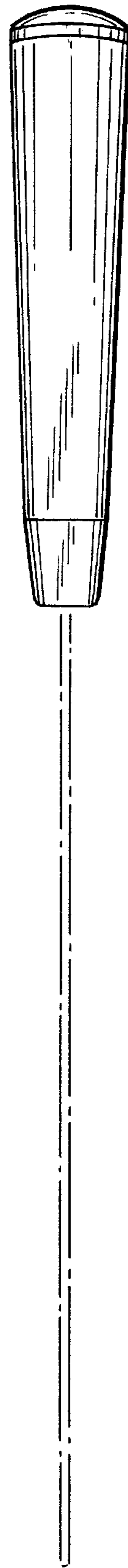
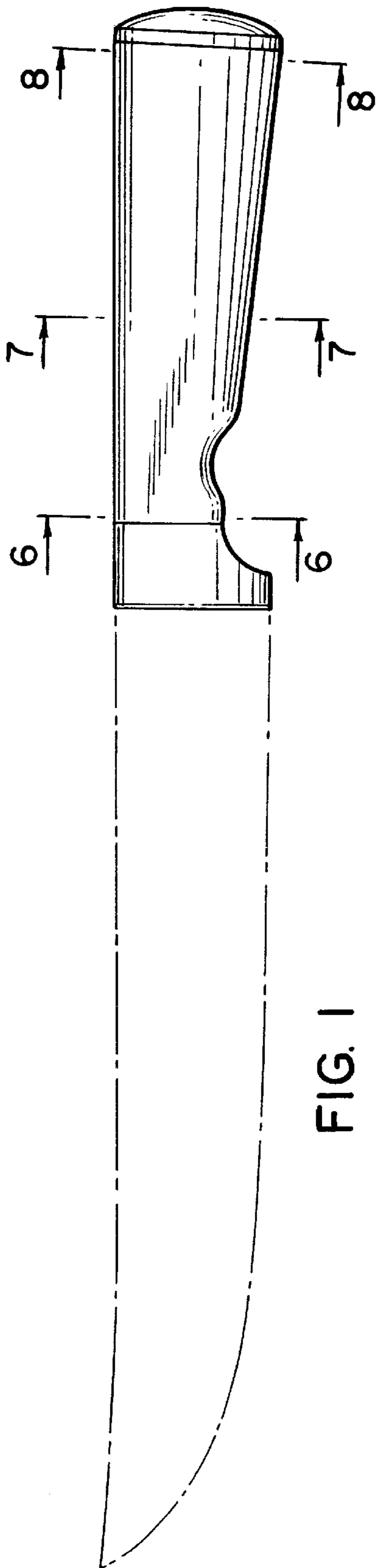

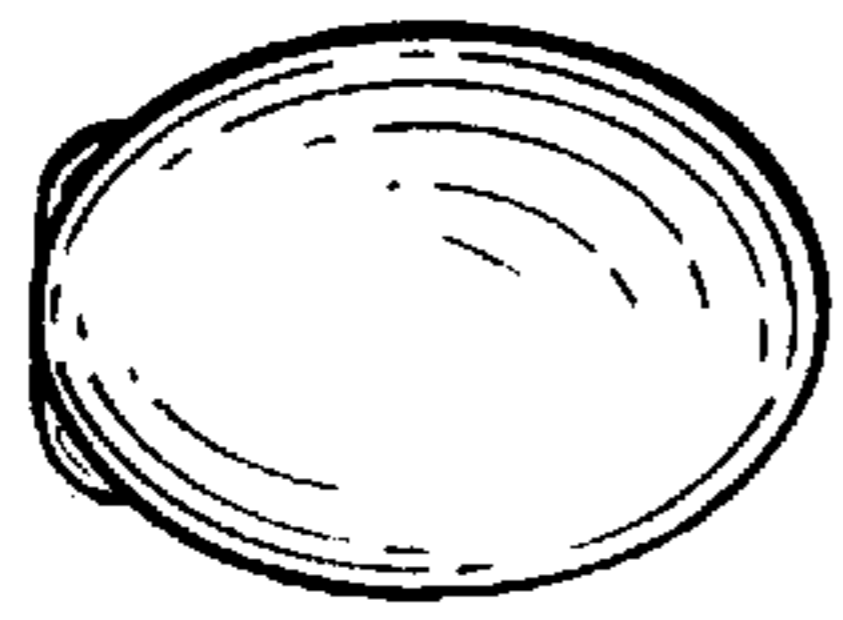

FIG. 3

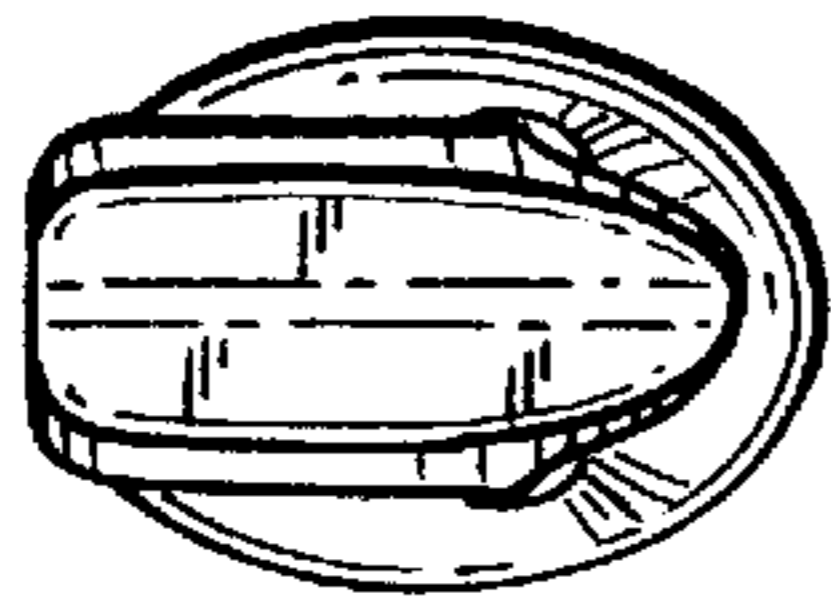

FIG. 4



FIG. 6



FIG. 7

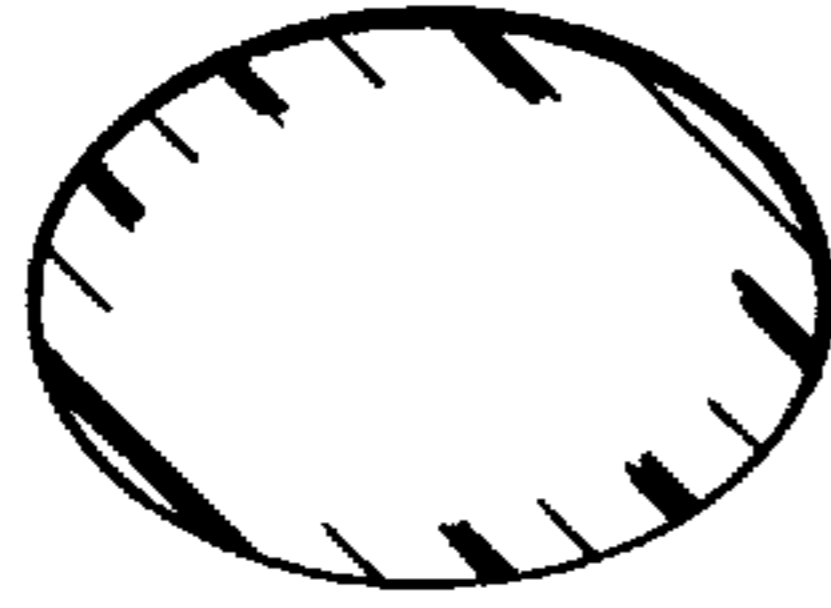

FIG. 8

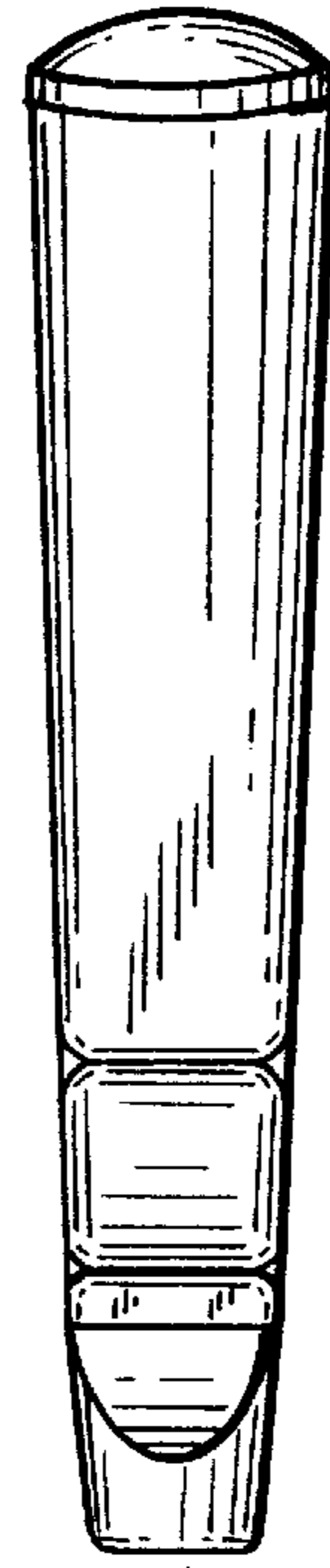

FIG. 5

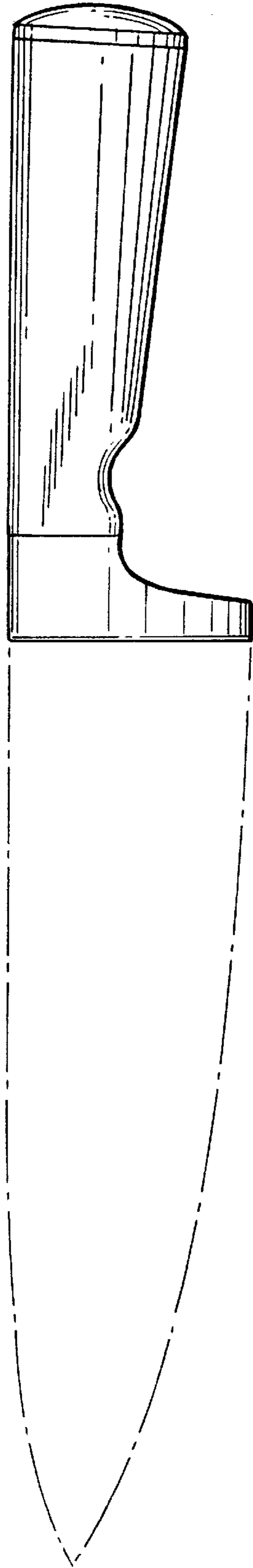

FIG. 9

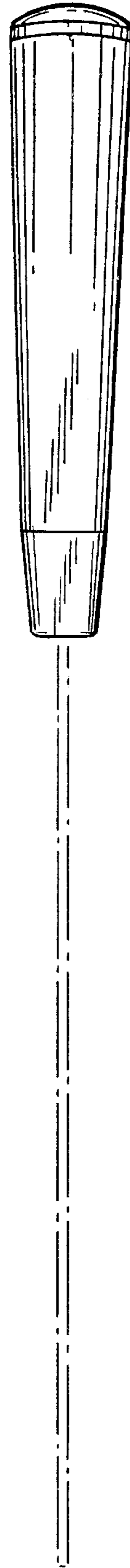

FIG. 10

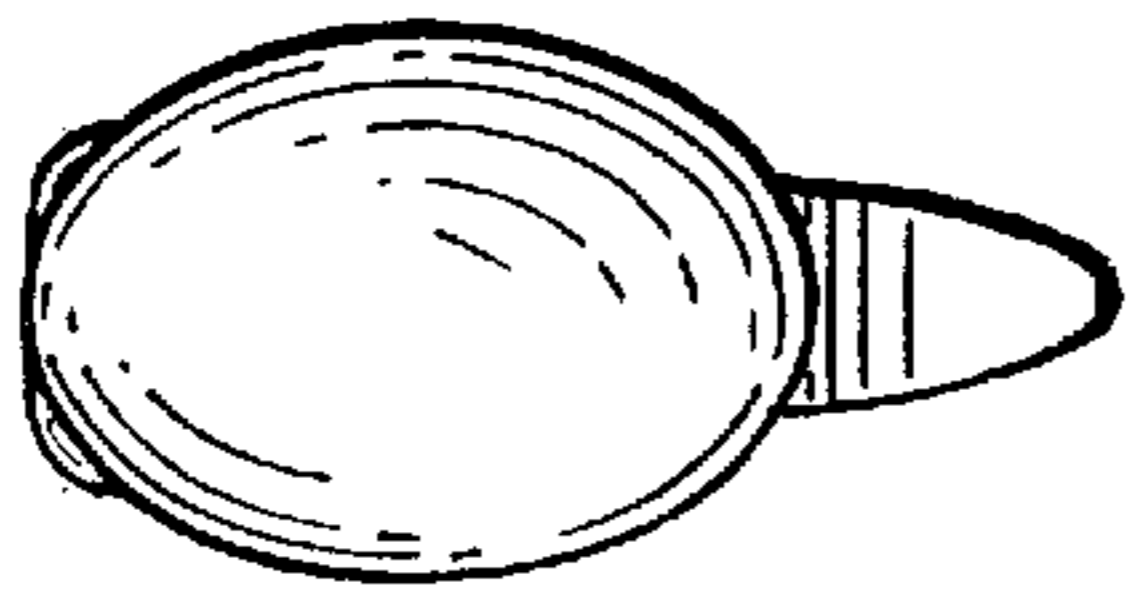

FIG. 11

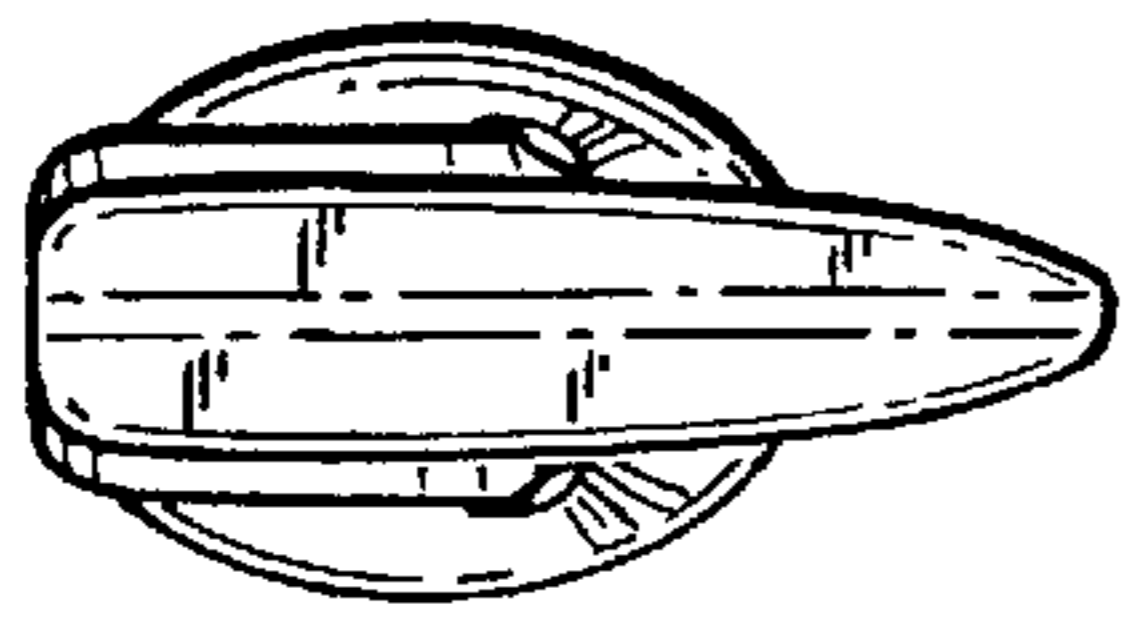

FIG. 12

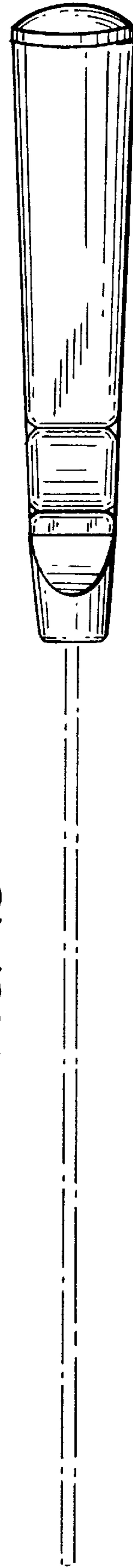

FIG. 13

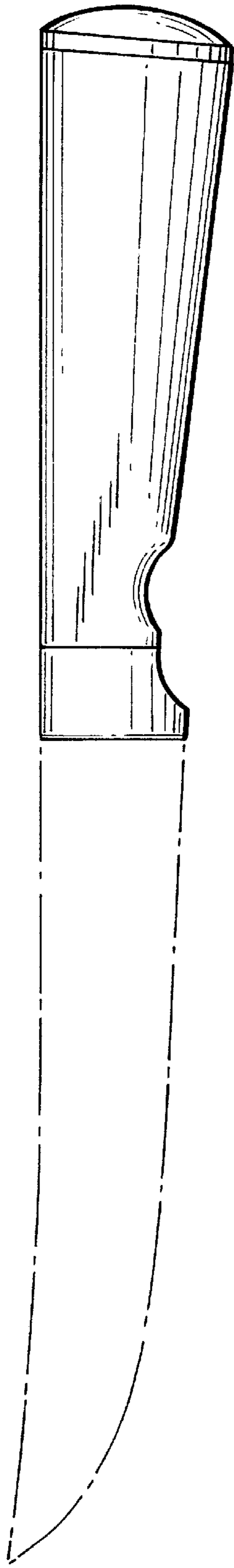

FIG. 14

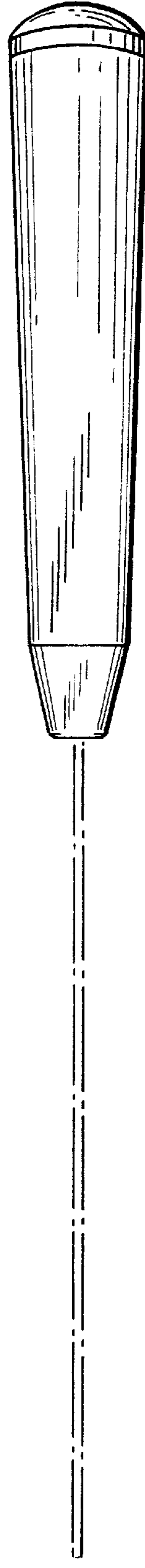

FIG. 15

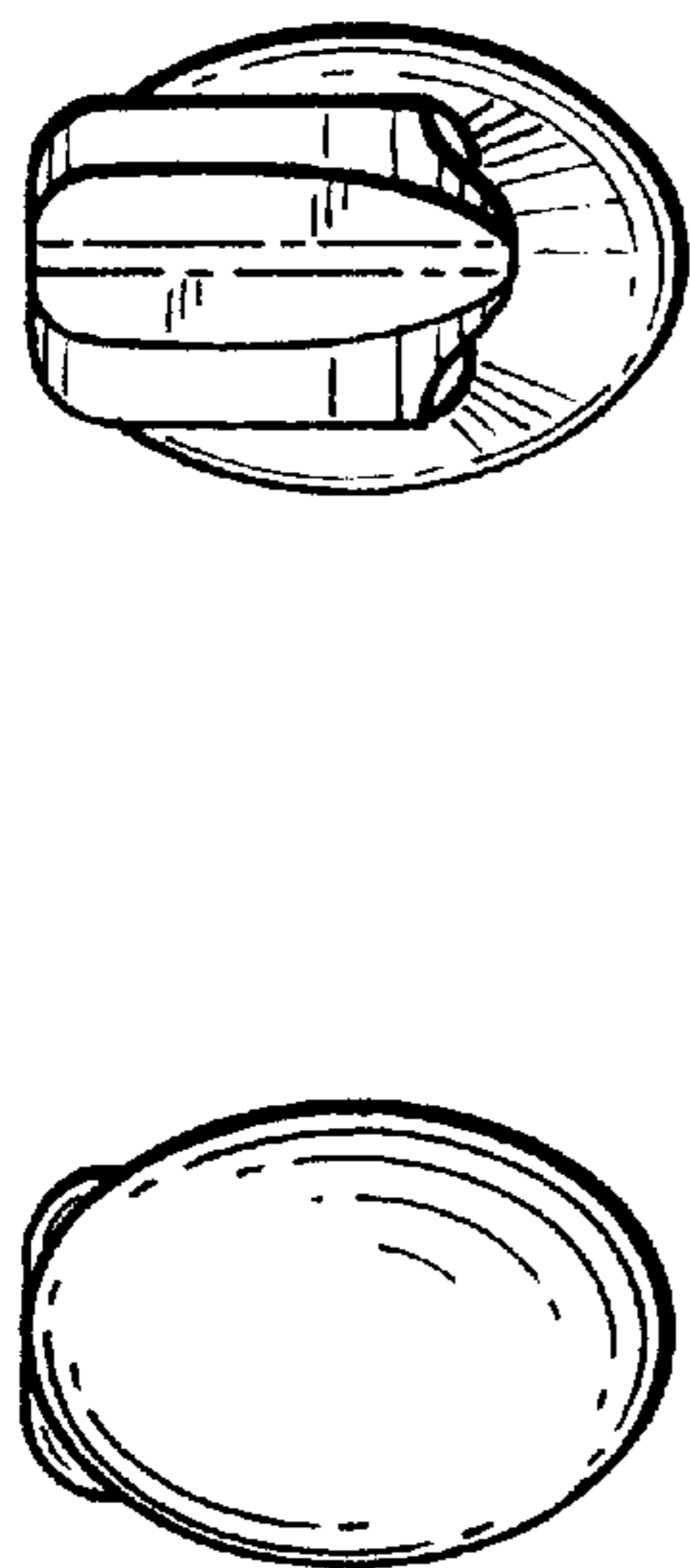

FIG. 16

FIG. 17

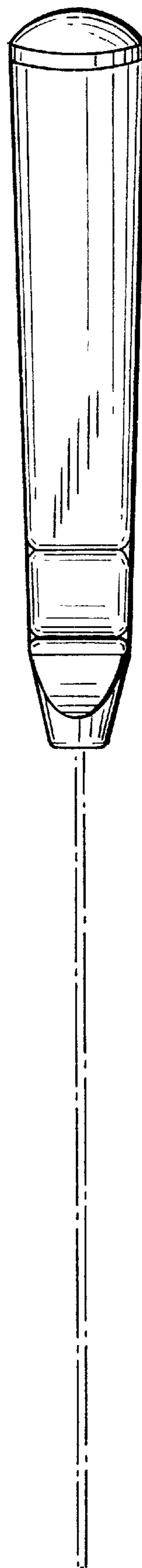

FIG. 18