



US00D474600S

(12) **United States Design Patent**
Lewis

(10) **Patent No.:** **US D474,600 S**

(45) **Date of Patent:** **** May 20, 2003**

(54) **MUSICIAN'S STAGE BOX**

(76) Inventor: **Keith A. Lewis**, 375 Brown Rd., Ennis, TX (US) 75119

(**) Term: **14 Years**

(21) Appl. No.: **29/166,640**

(22) Filed: **Aug. 28, 2002**

(51) **LOC (7) Cl.** **03-01**

(52) **U.S. Cl.** **D3/284; D3/298; D3/295**

(58) **Field of Search** **D3/273, 283, 284, D3/294, 295, 296, 297, 298; 206/314, 315.1, 315.11, 349, 372, 373; 312/117**

Illustrations of Star Case cases off of Starcase.com websight.

Illustrations of Amptown flight cases off of amptown-case.co.uk/flightcases.

Illustrations of Genz-Benz cases off of genz-benz.com websight.

* cited by examiner

Primary Examiner—Philip S. Hyder

(74) *Attorney, Agent, or Firm*—John R. Lansdowne

(57) **CLAIM**

The ornamental design for a musician's stage box, as shown and described.

(56) **References Cited**

U.S. PATENT DOCUMENTS

D94,708 S	*	2/1935	Piffath	D3/284
D228,820 S	*	10/1973	Day	D3/284
4,244,632 A	*	1/1981	Molinari	312/231
4,303,158 A	*	12/1981	Perkins	206/373
D281,837 S	*	12/1985	Lin	D3/284
4,832,193 A	*	5/1989	Kime	206/372
D318,175 S	*	7/1991	Venanzini	D3/284
5,456,358 A	*	10/1995	Schmidt	206/373
5,806,673 A		9/1998	Sanderson	206/314
5,829,615 A		11/1998	Rickinger et al.	220/4.01
D402,462 S		12/1998	Sanderson	D3/276
D447,870 S		9/2001	Purcel	D3/272
D460,259 S	*	7/2002	Oelfke	D3/284

OTHER PUBLICATIONS

Illustrations of Rock Hard cases off of internet Rockhard-case.com.

Illustrations of Continental cases off of Continentalcase.com websight.

DESCRIPTION

FIG. 1 is a perspective view of a musician's stage box showing my new design, with the top and bottom covers removed and a sliding tray in the bottom compartment extended;

FIG. 2 top plan view thereof;

FIG. 3 is a bottom plan view thereof;

FIG. 4 is a front elevation view thereof;

FIG. 5 is a rear elevation view thereof;

FIG. 6 is a right side elevation view thereof;

FIG. 7 is a left side elevation view thereof; and,

FIG. 8 is a perspective view thereof, with said top and bottom covers in place and said tray retracted.

The broken line portions of the disclosure are for illustrative purposes only and form no part of the claimed design.

1 Claim, 8 Drawing Sheets

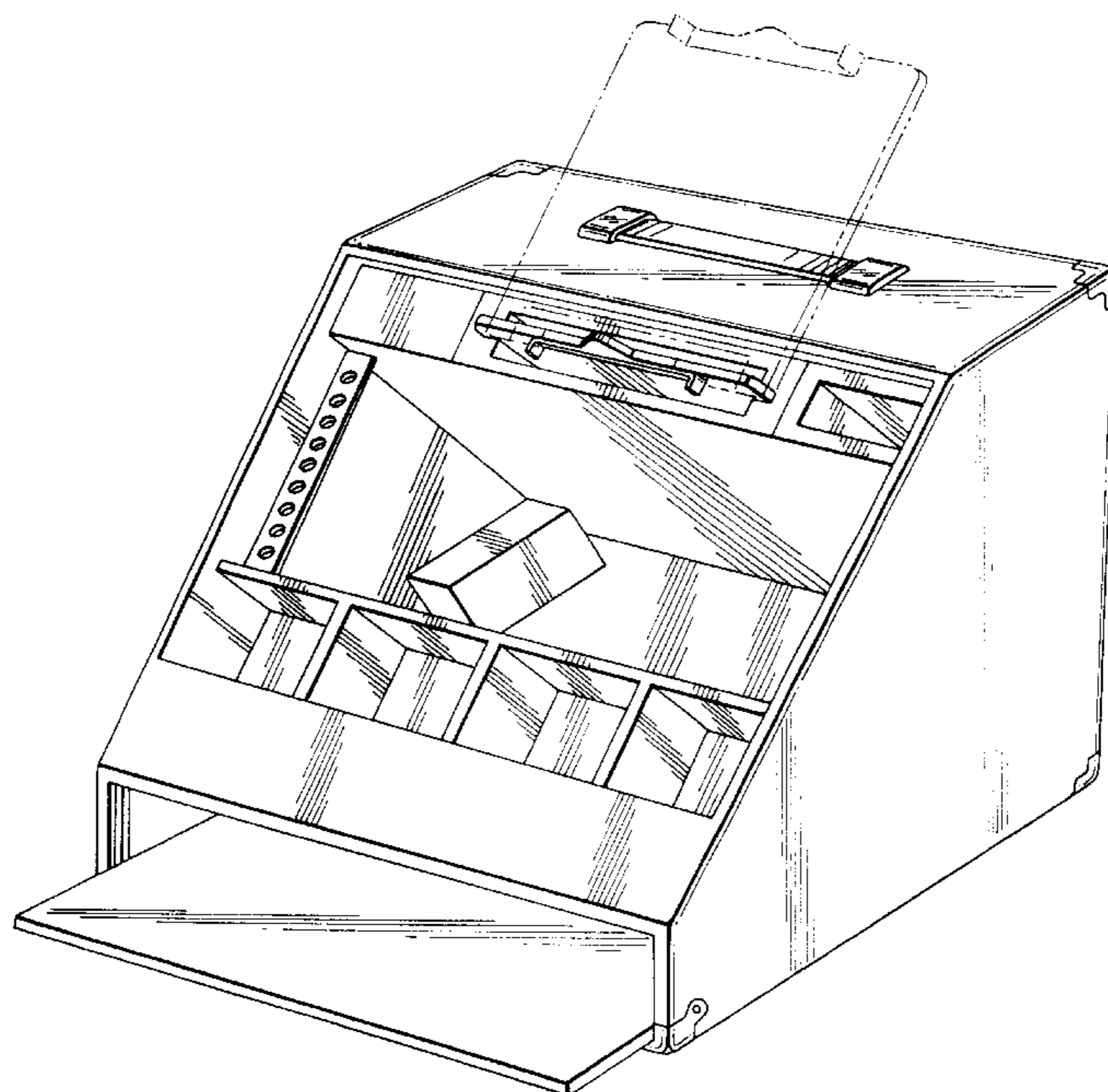

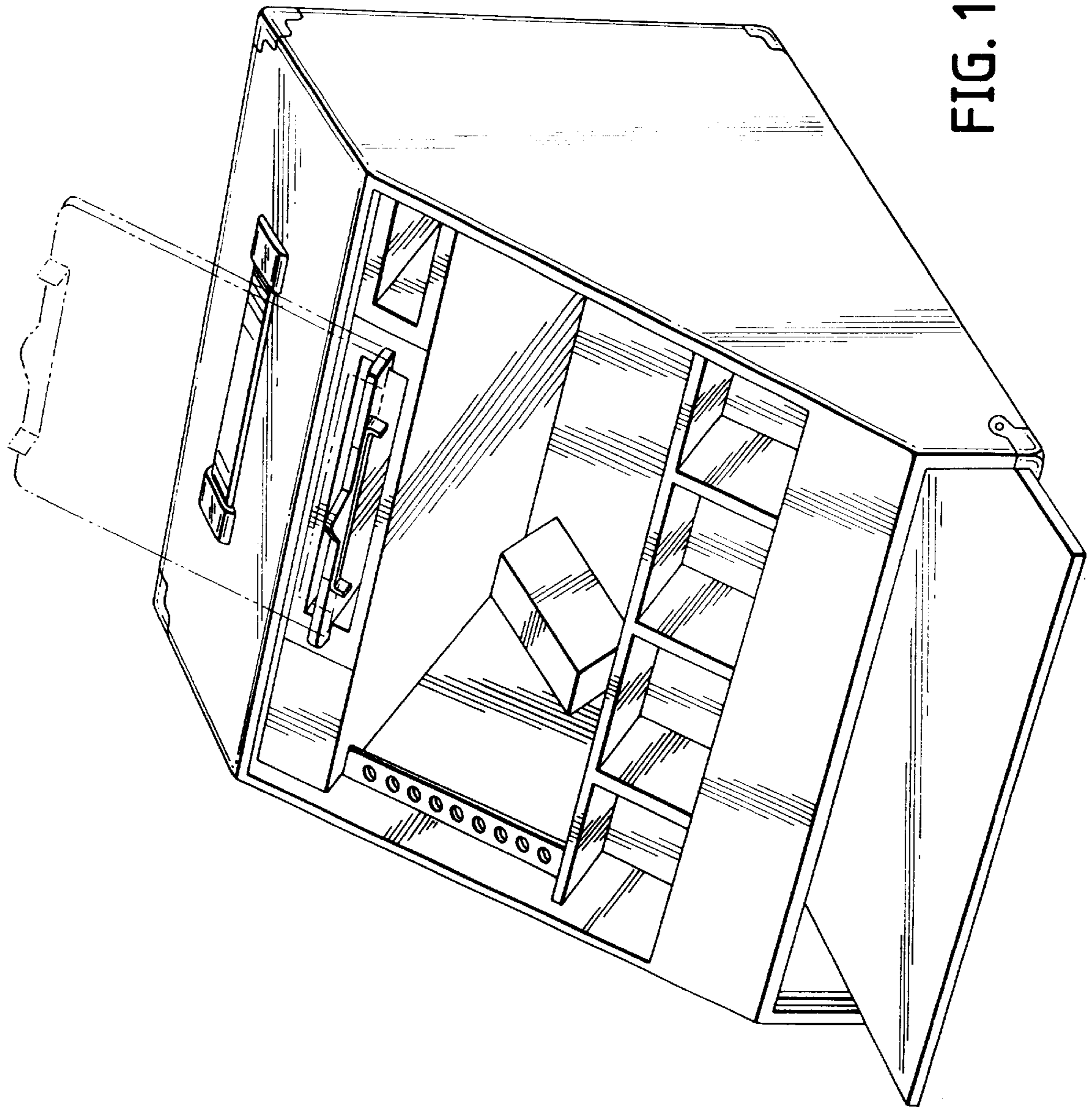

FIG. 1

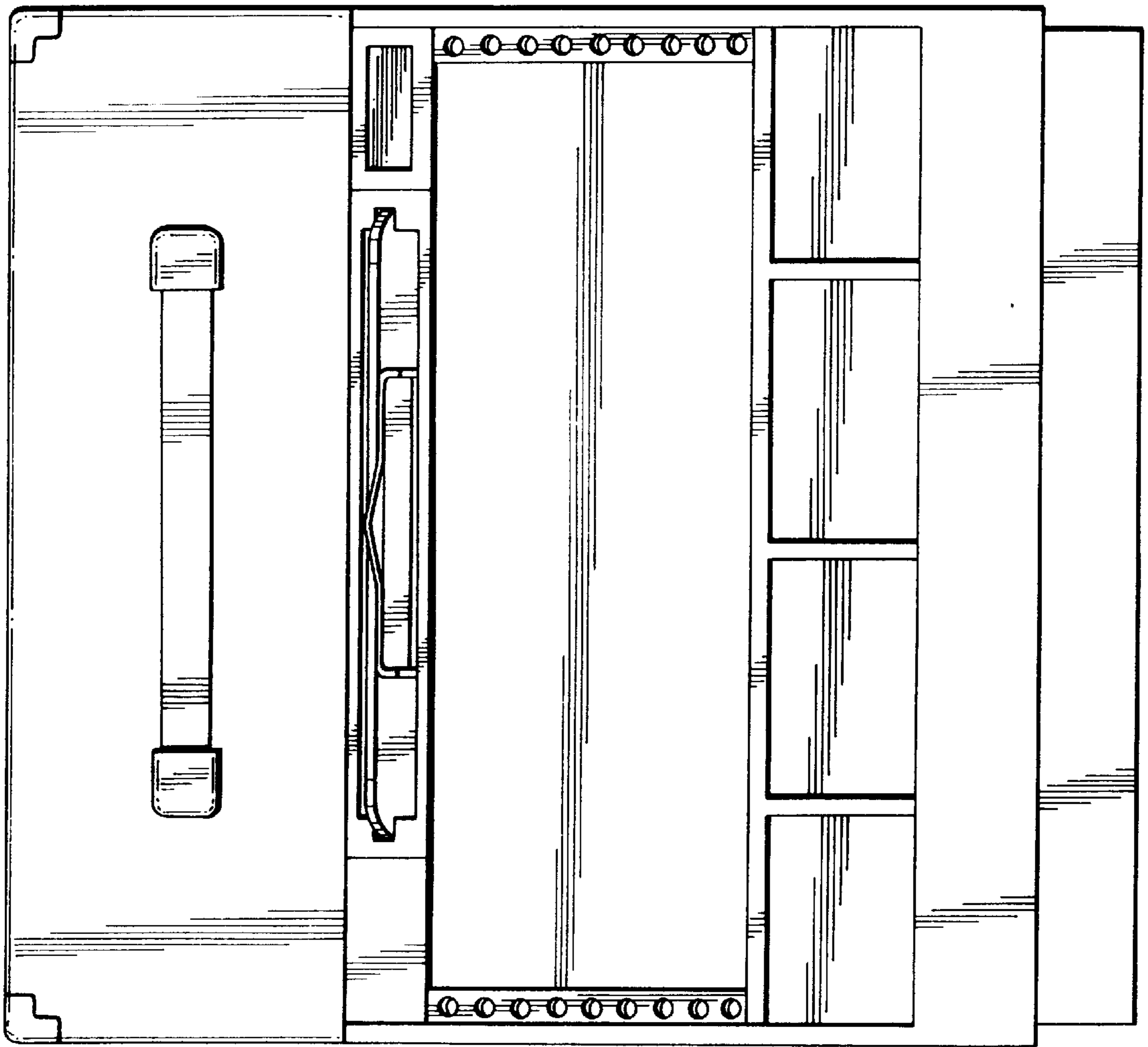

FIG. 2

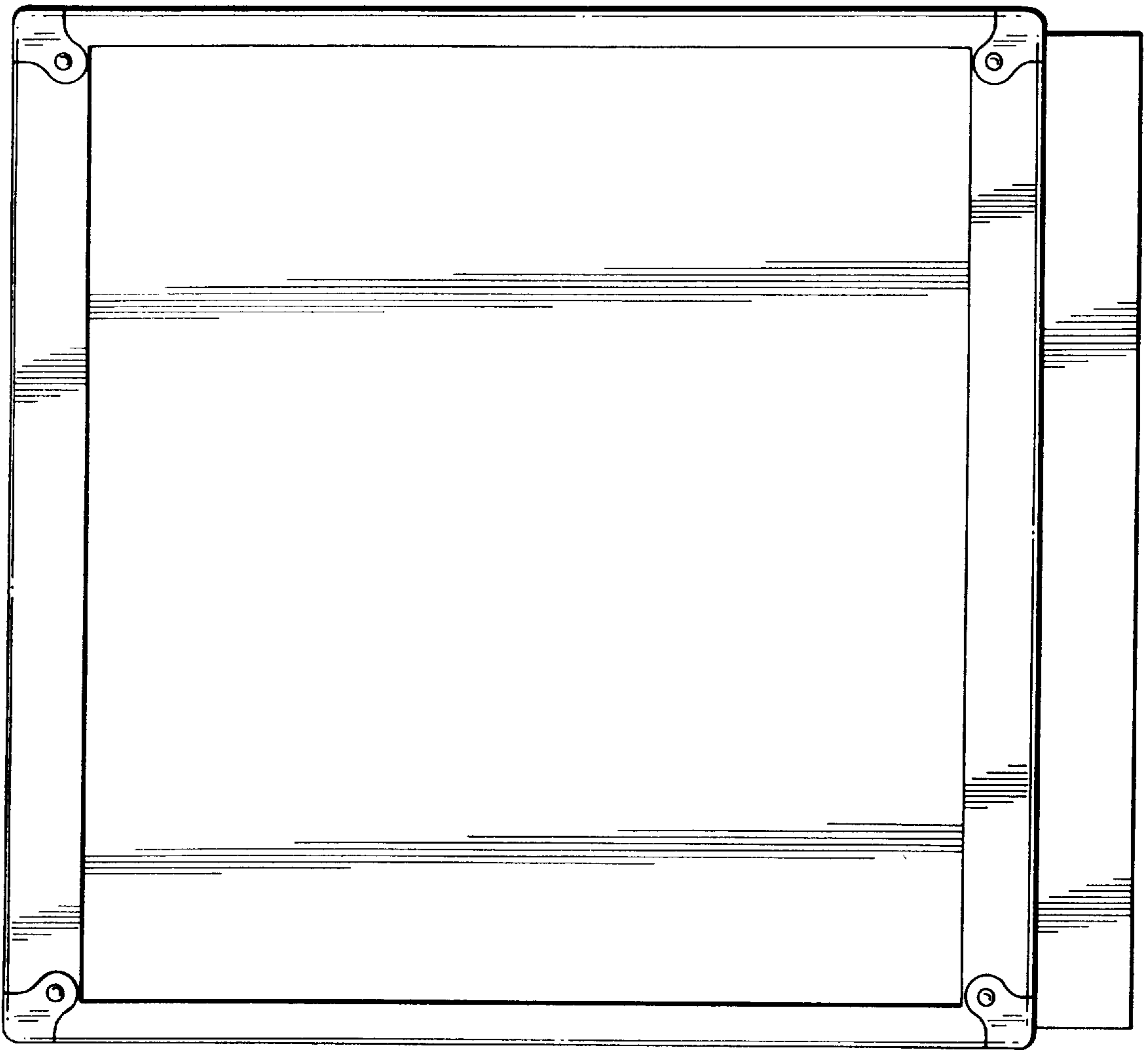

FIG. 3

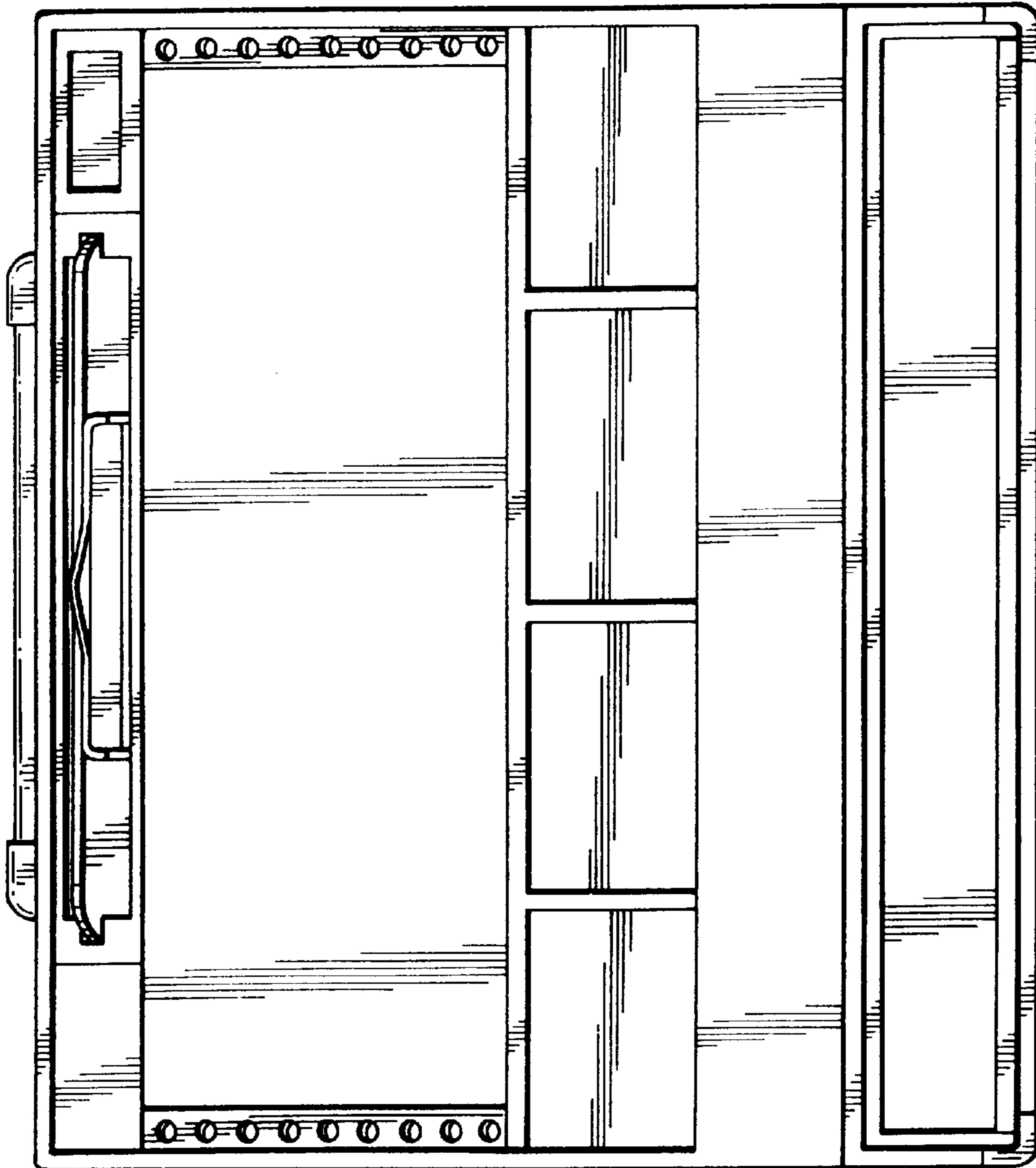

FIG. 4

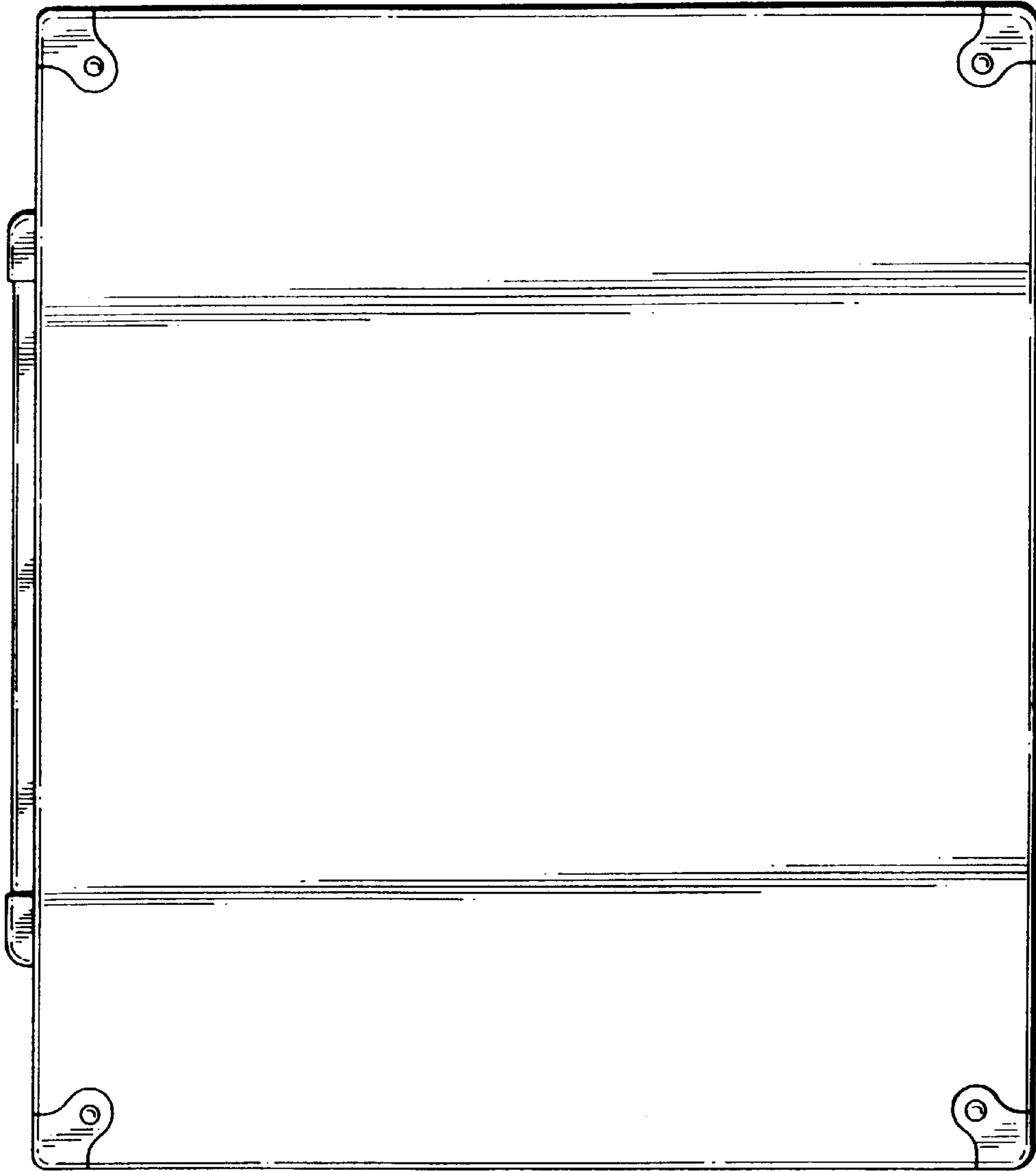

FIG. 5

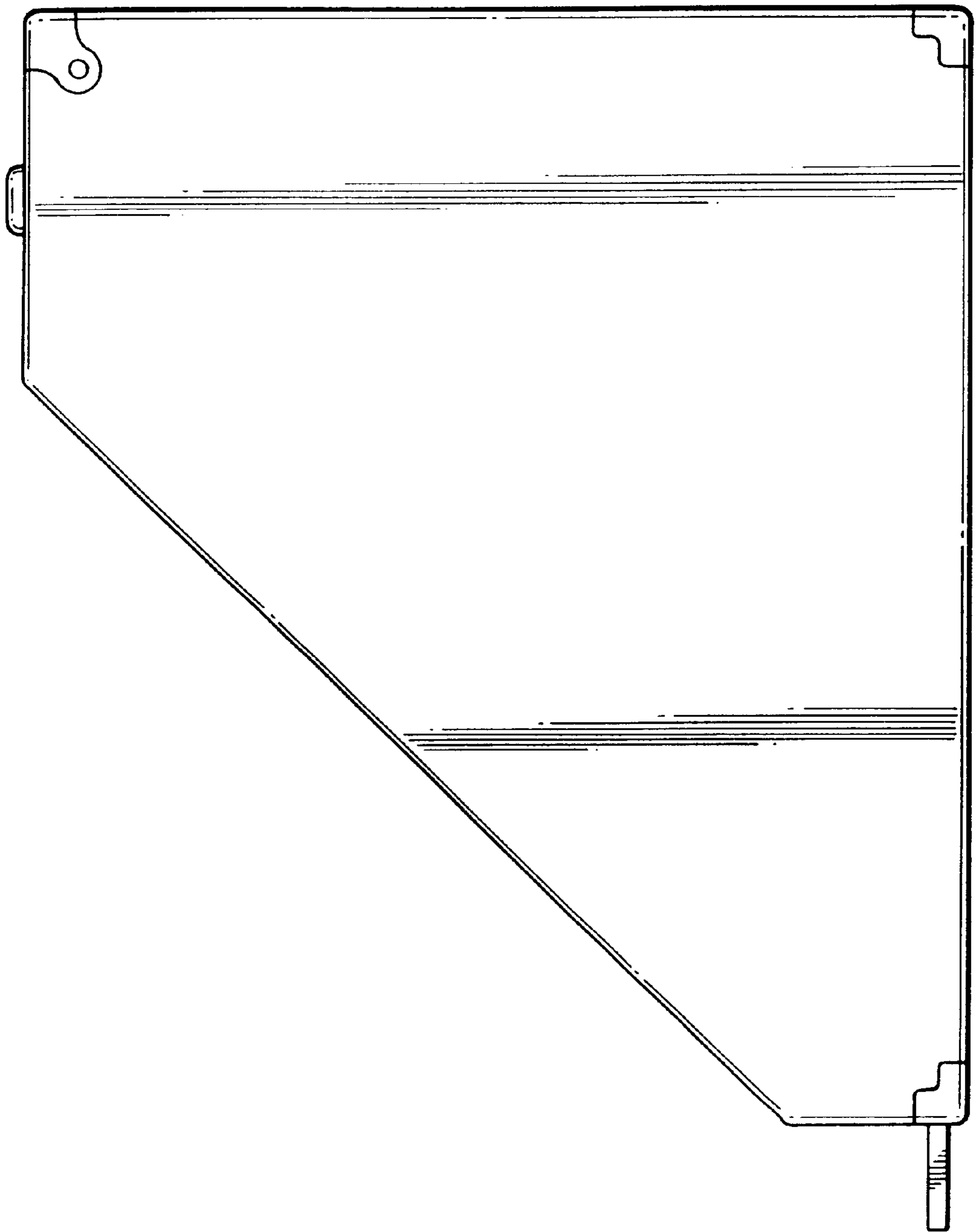

FIG. 6

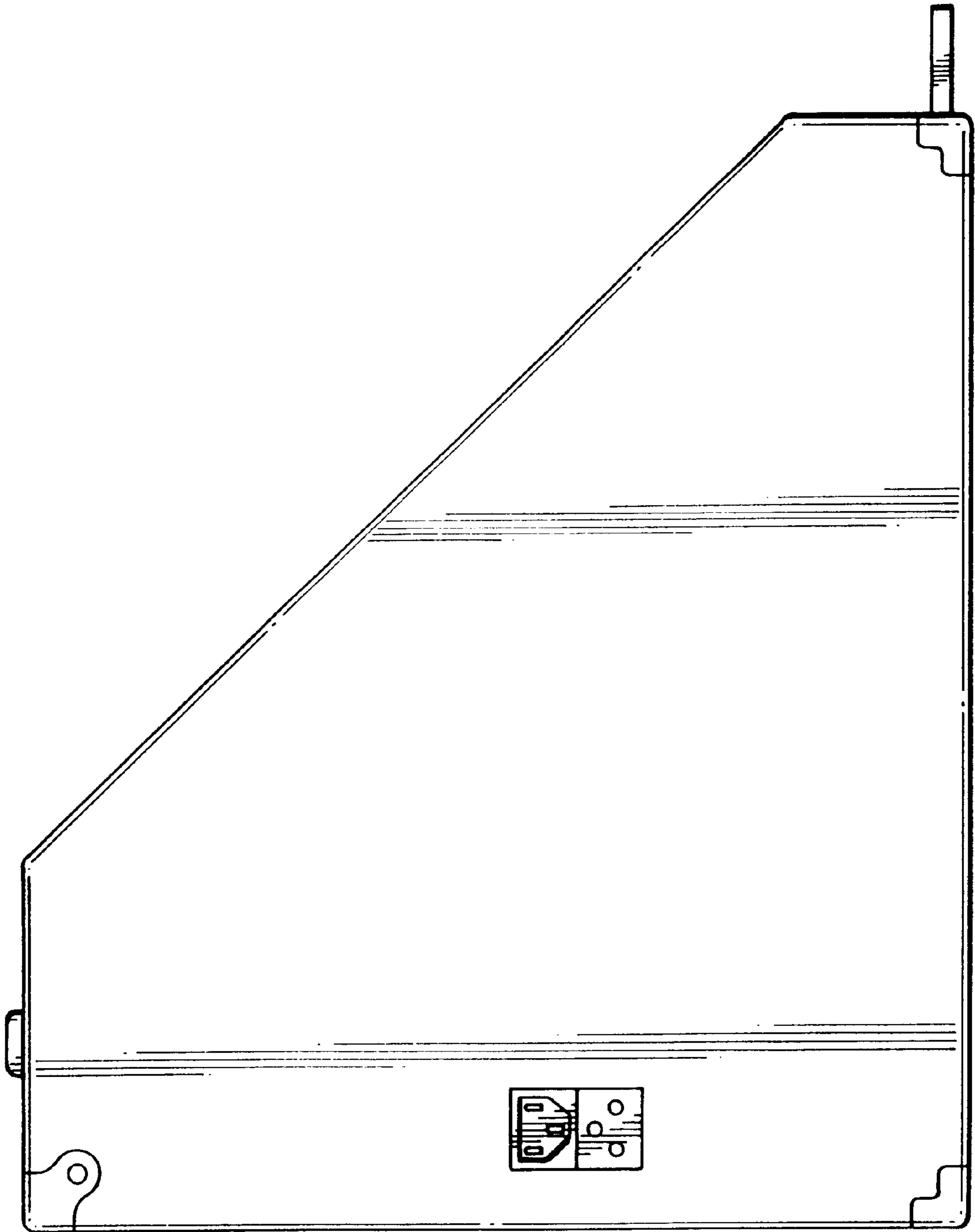

FIG. 7

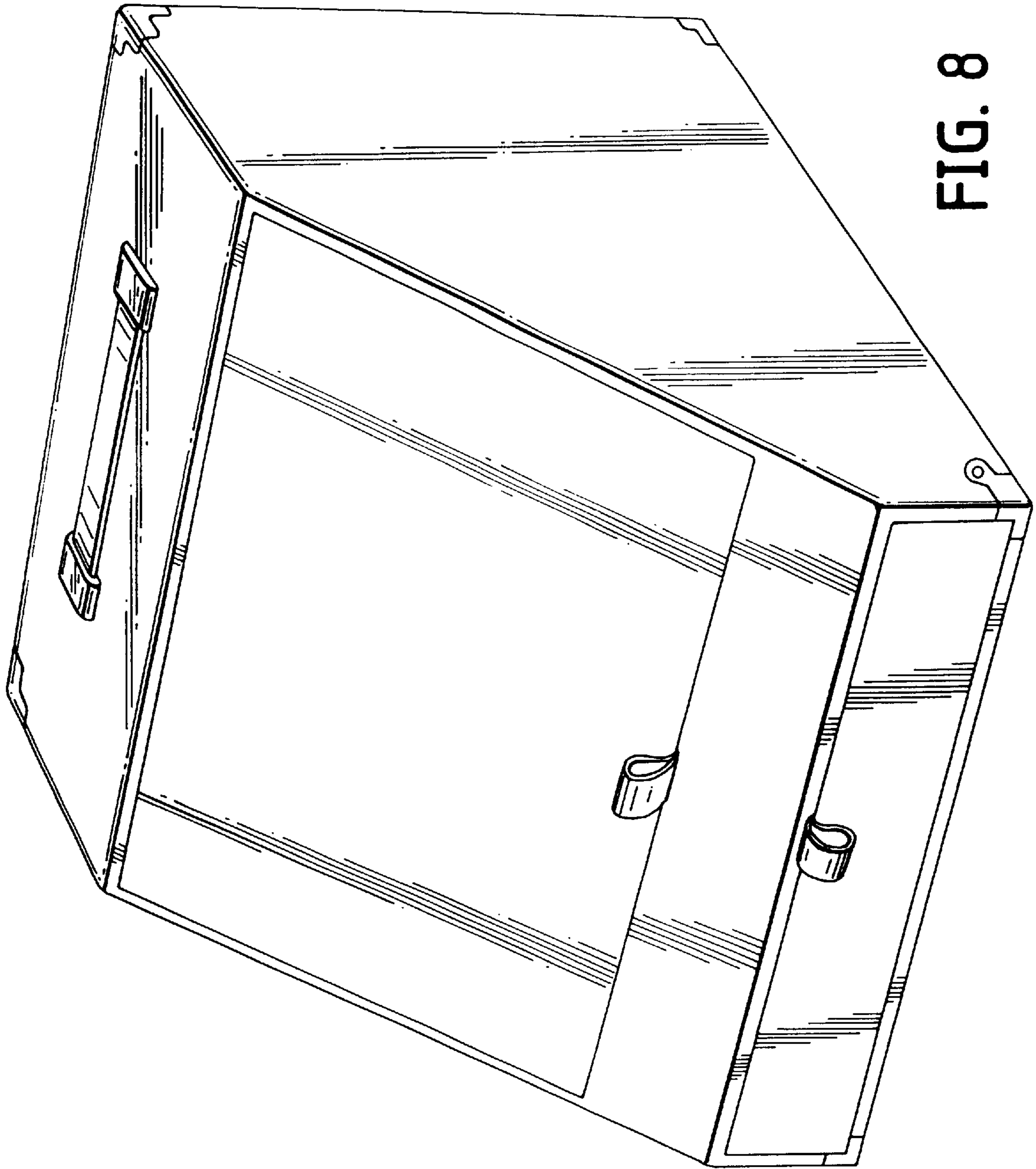

FIG. 8