



US00D474596S

(12) **United States Design Patent**  
**Osiecki et al.**

(10) **Patent No.:** **US D474,596 S**

(45) **Date of Patent:** **\*\* May 20, 2003**

(54) **STEP-UP CASE**

D446,011 S \* 8/2001 Ogilvie et al. .... D3/273

\* cited by examiner

(75) Inventors: **Scott W. Osiecki**, Skaneateles, NY  
(US); **Peter F. Lynch**, Skaneateles, NY  
(US); **Timothy R. Fitch**, Syracuse, NY  
(US)

*Primary Examiner*—Philip S. Hyder  
(74) *Attorney, Agent, or Firm*—Ronald S. Kareken; Jaekle  
Fleischmann & Mugel, LLP

(73) Assignee: **John D. Brush & Co., Inc.**, Rochester,  
NY (US)

(57) **CLAIM**

(\*\*) Term: **14 Years**

We claim the ornamental design for a step-up case, as shown  
and described.

(21) Appl. No.: **29/159,937**

**DESCRIPTION**

(22) Filed: **Apr. 30, 2002**

FIG. 1 is a perspective view of a step-up case, showing my  
new design.

(51) **LOC (7) Cl.** ..... **03-01**

FIG. 2 is a front side view.

(52) **U.S. Cl.** ..... **D3/273; D99/28**

FIG. 3 is a back side view.

(58) **Field of Search** ..... D3/273, 272, 281,  
D3/291, 294, 295; D99/28; 109/45, 46,  
48, 49

FIG. 4 is a left side view.

FIG. 5 is a right side view.

FIG. 6 is a top view.

FIG. 7 is a bottom view.

(56) **References Cited**

FIG. 8 is a perspective view of a second embodiment of the  
step-up case.

FIG. 9 is a front side view.

FIG. 10 is a back side view.

FIG. 11 is a right side view.

FIG. 12 is a left side view.

FIG. 13 is a top view; and,

FIG. 14 is a bottom view.

**U.S. PATENT DOCUMENTS**

- D289,582 S \* 5/1987 Brush et al. .... D3/281
- D302,491 S \* 8/1989 Brush et al. .... D3/294
- D335,378 S \* 5/1993 Mariol ..... D99/28
- 5,377,514 A \* 1/1995 Robbins et al. .... 70/452
- D386,307 S \* 11/1997 Naas et al. .... D3/294
- D399,632 S \* 10/1998 Davis et al. .... D99/28

**1 Claim, 10 Drawing Sheets**

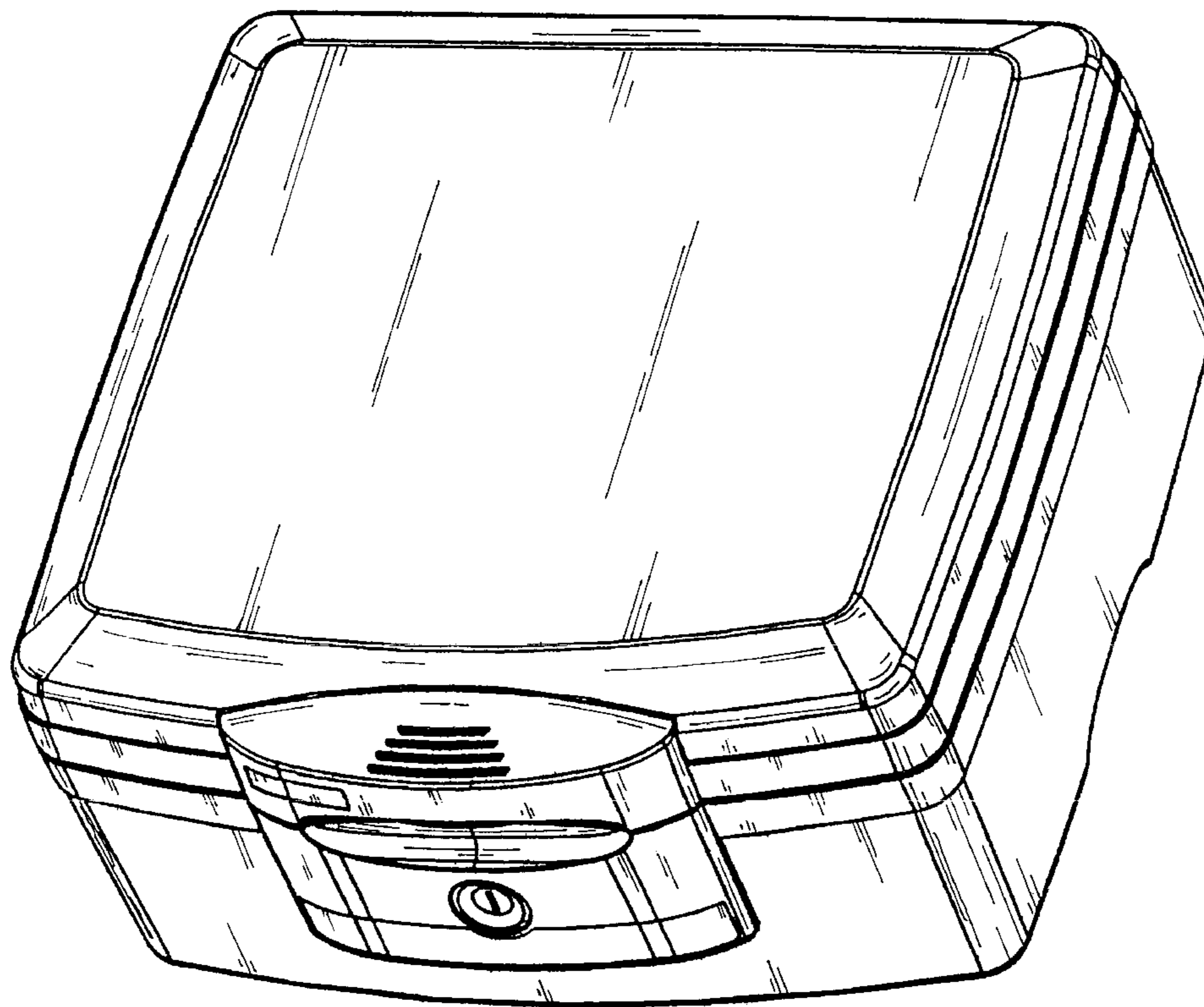

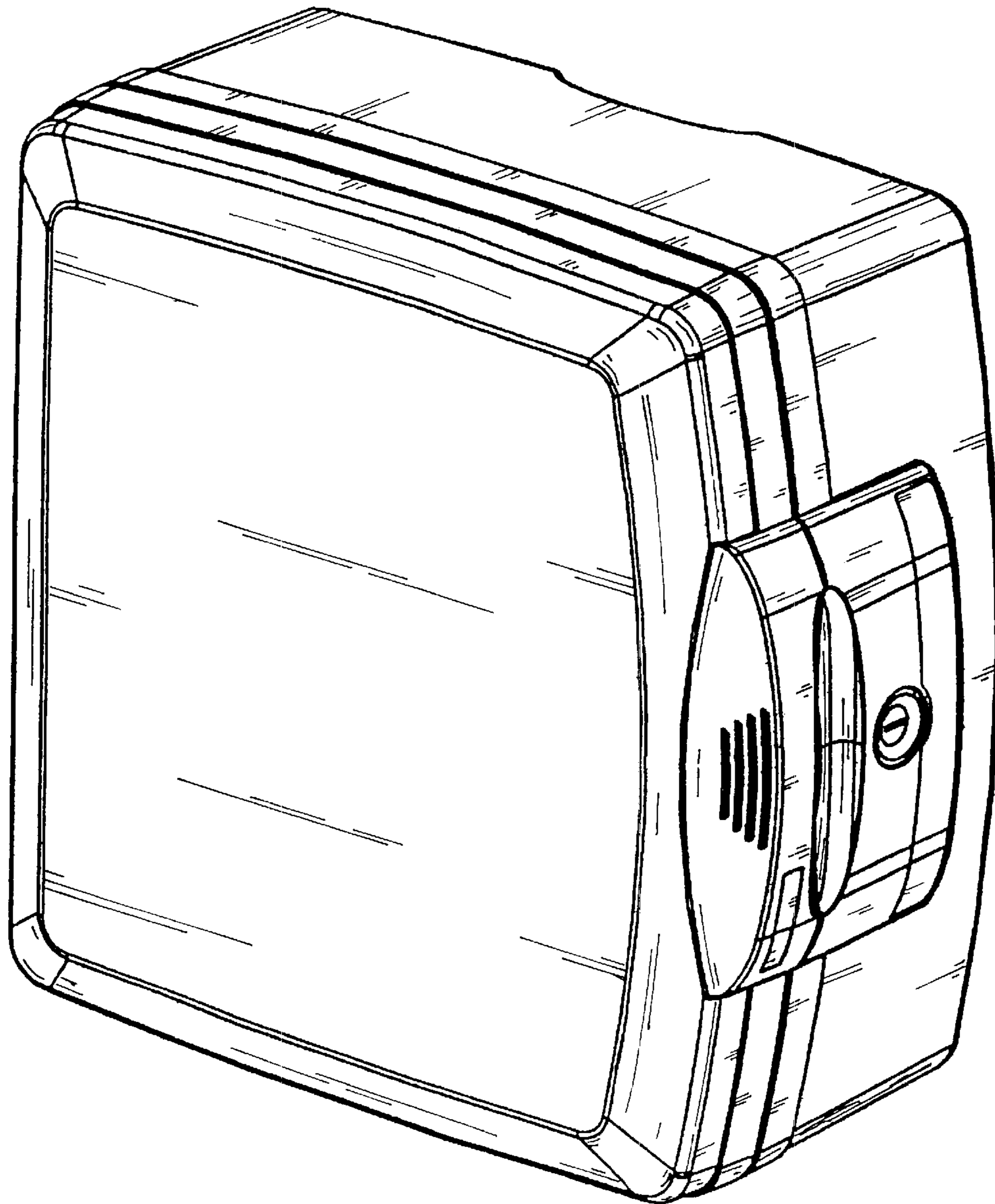

FIG. 1

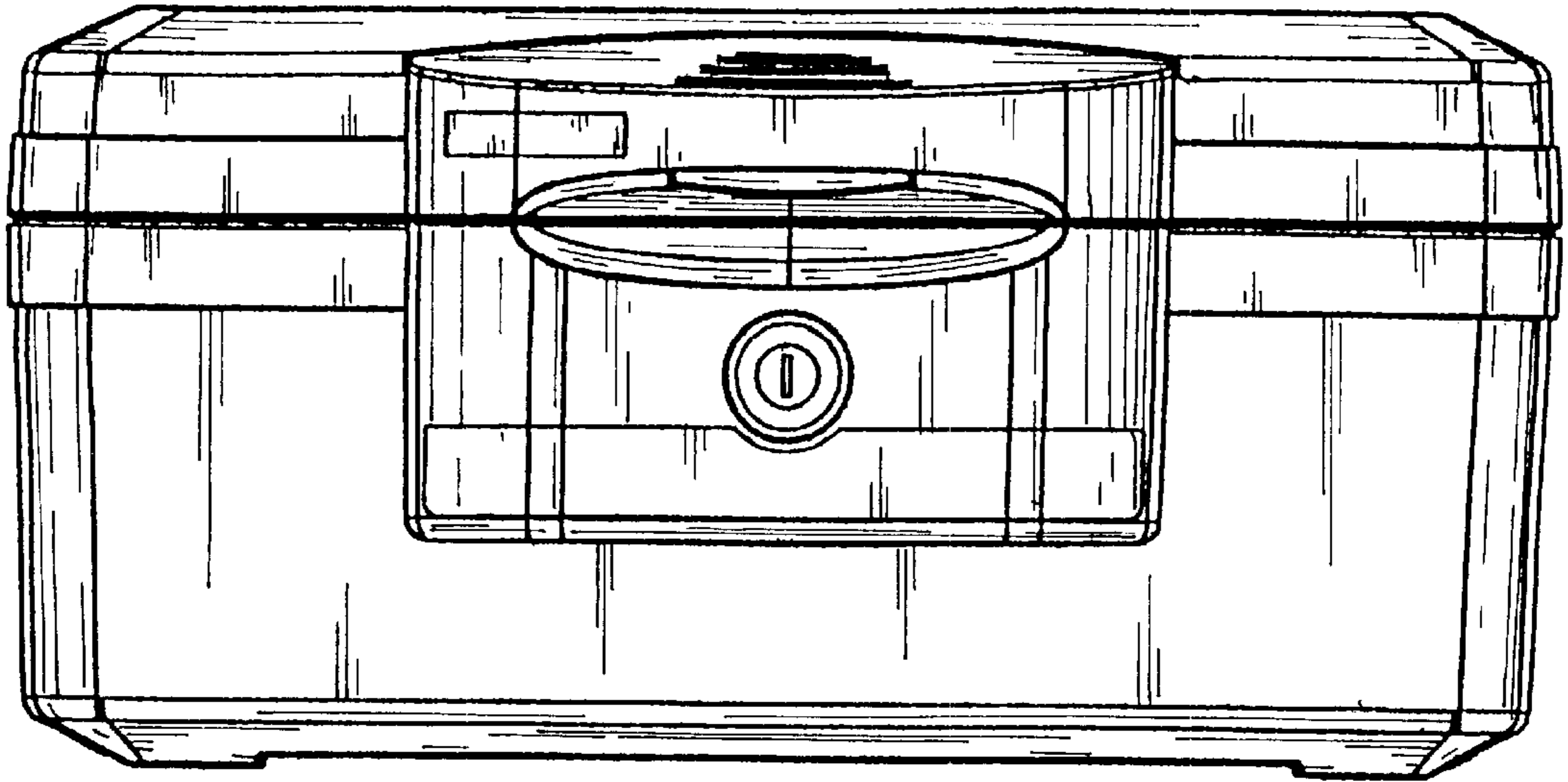

FIG. 2

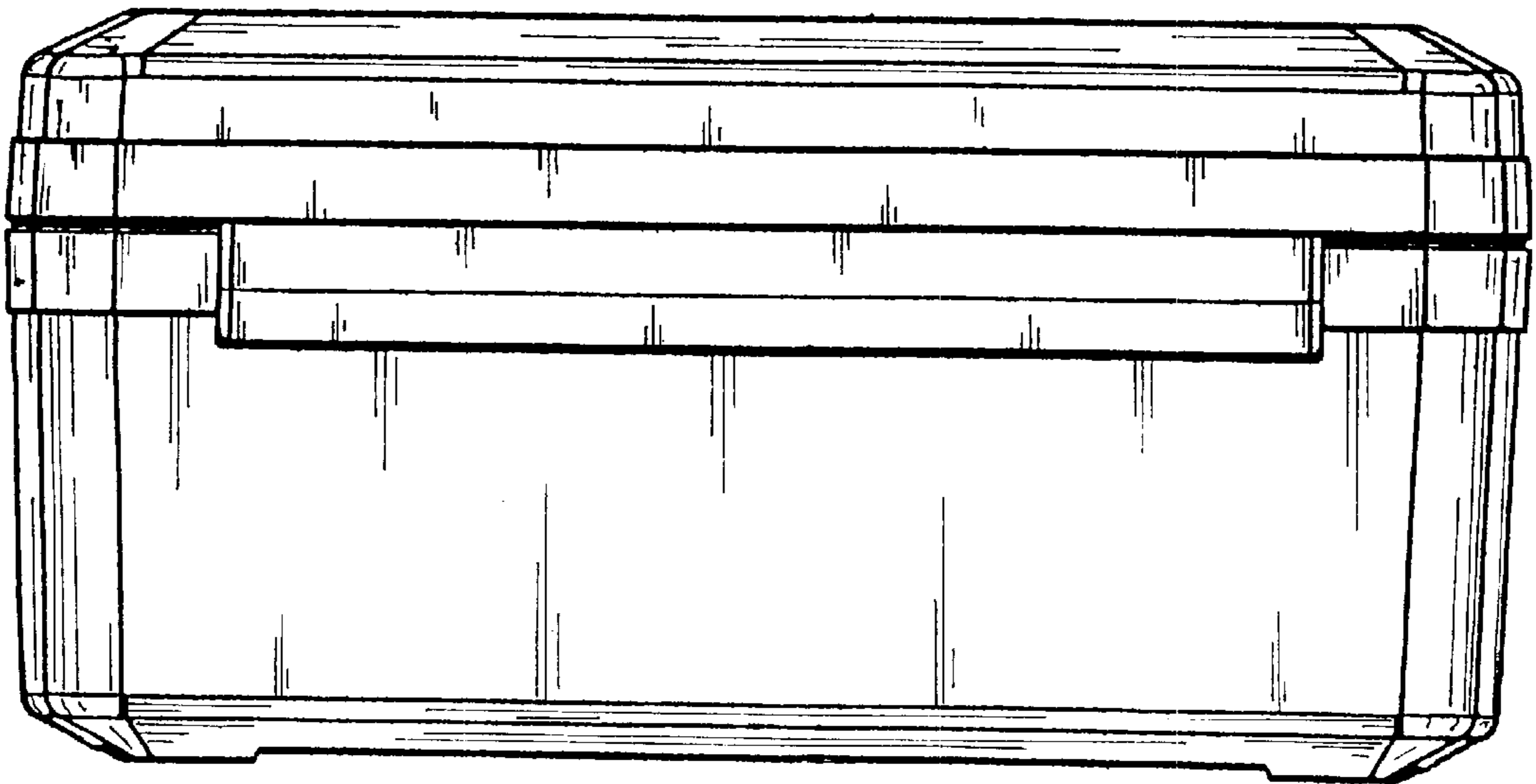

FIG. 3

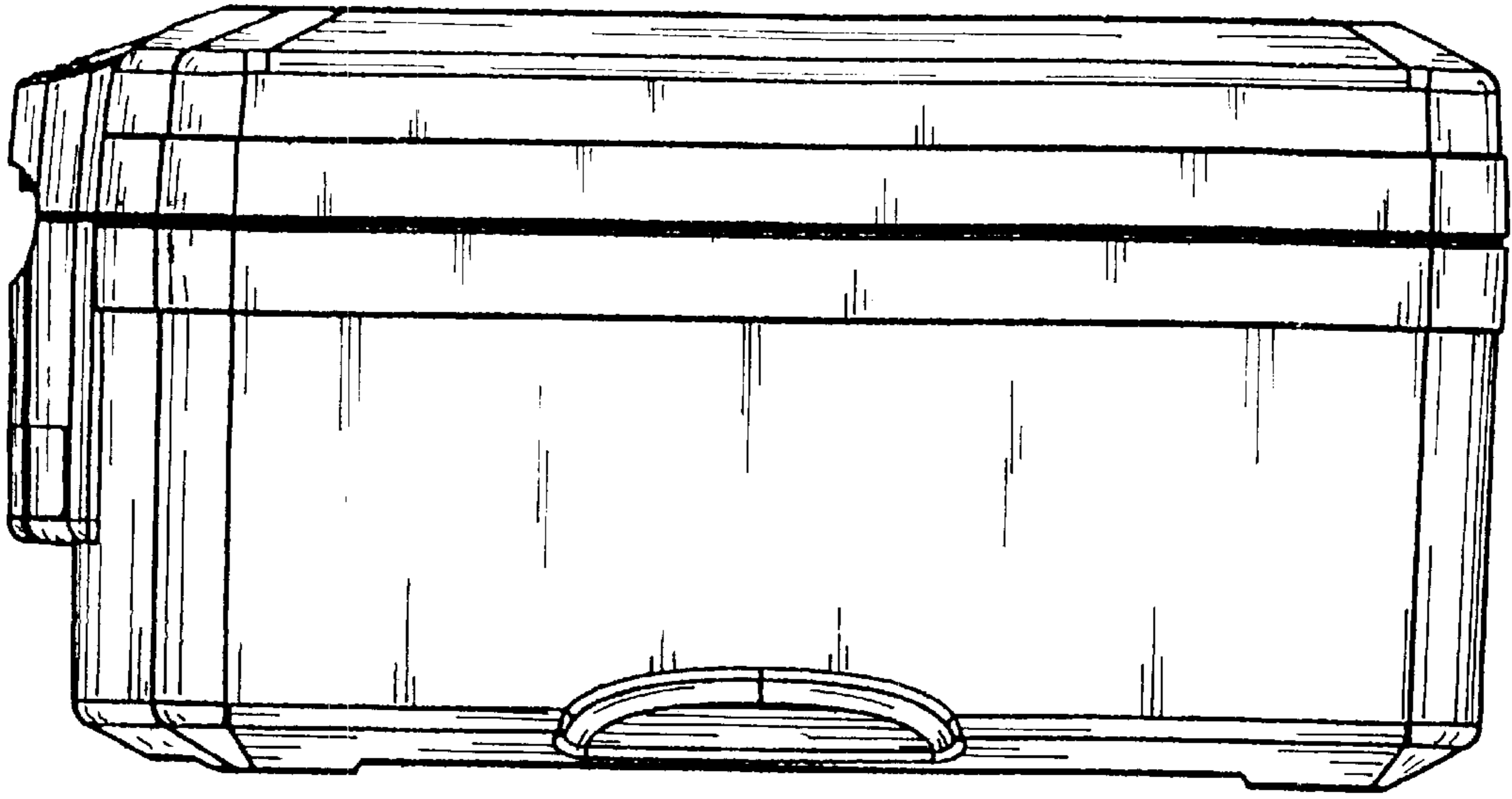

FIG. 4

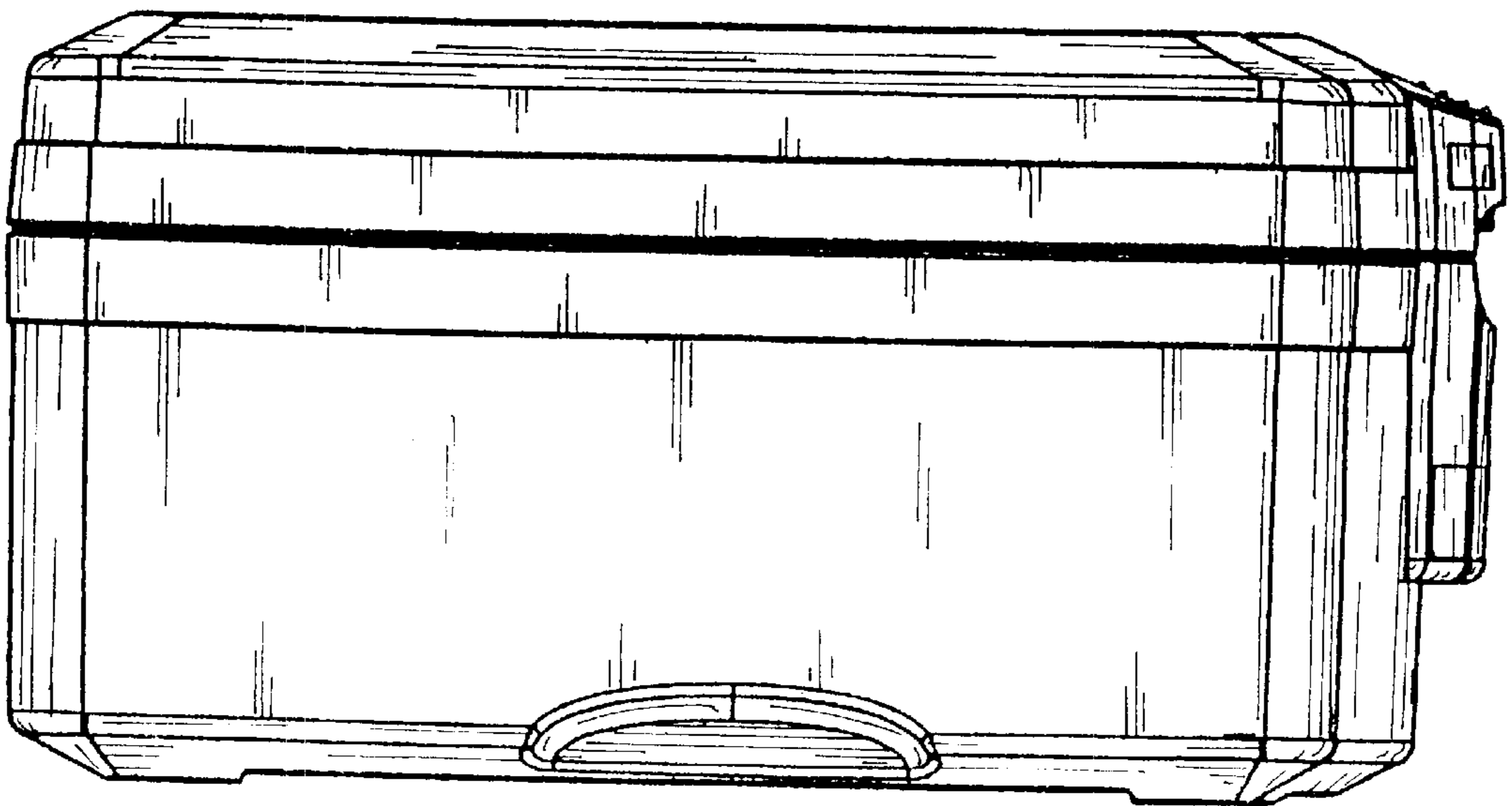

FIG. 5

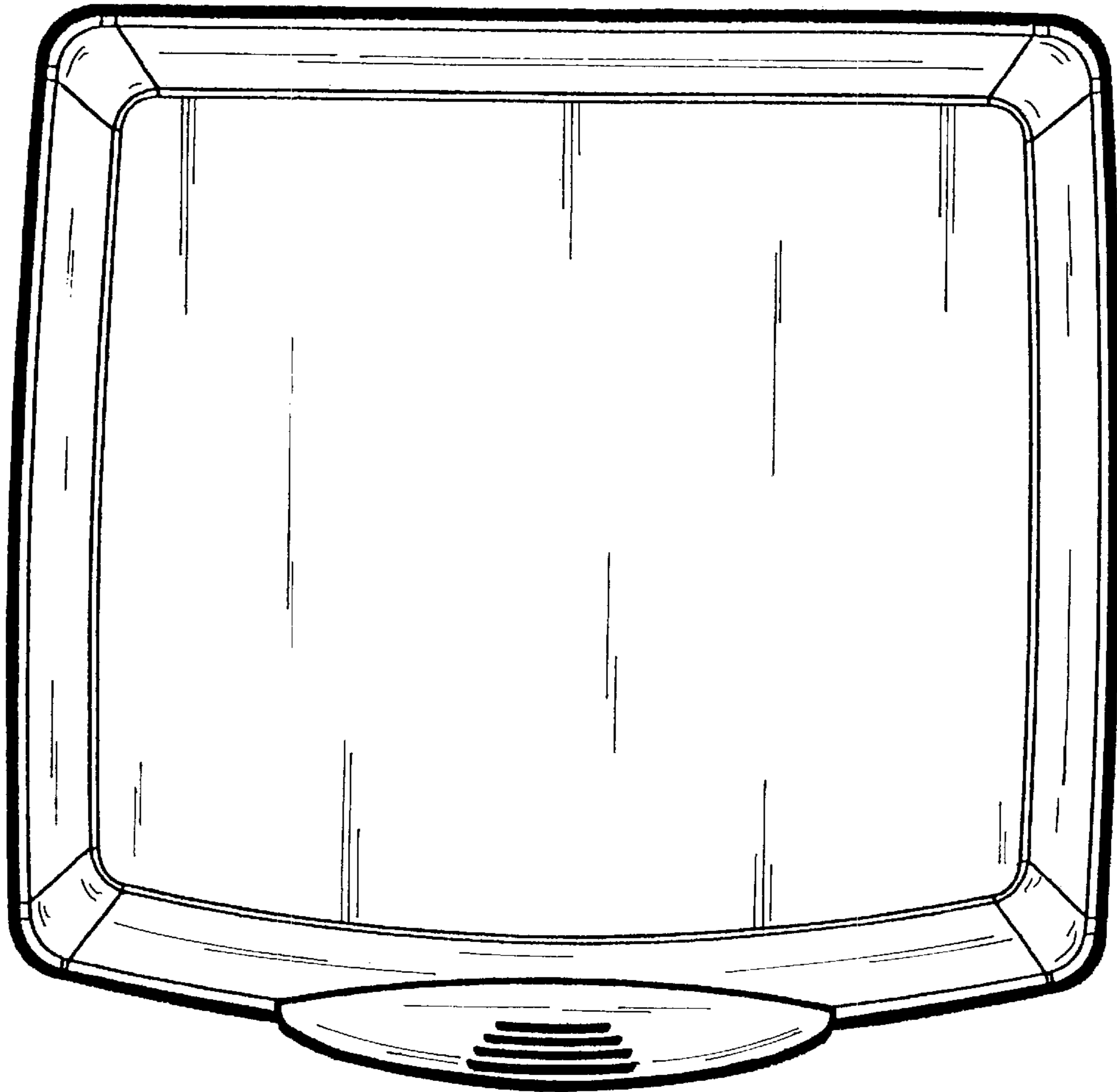

FIG. 6



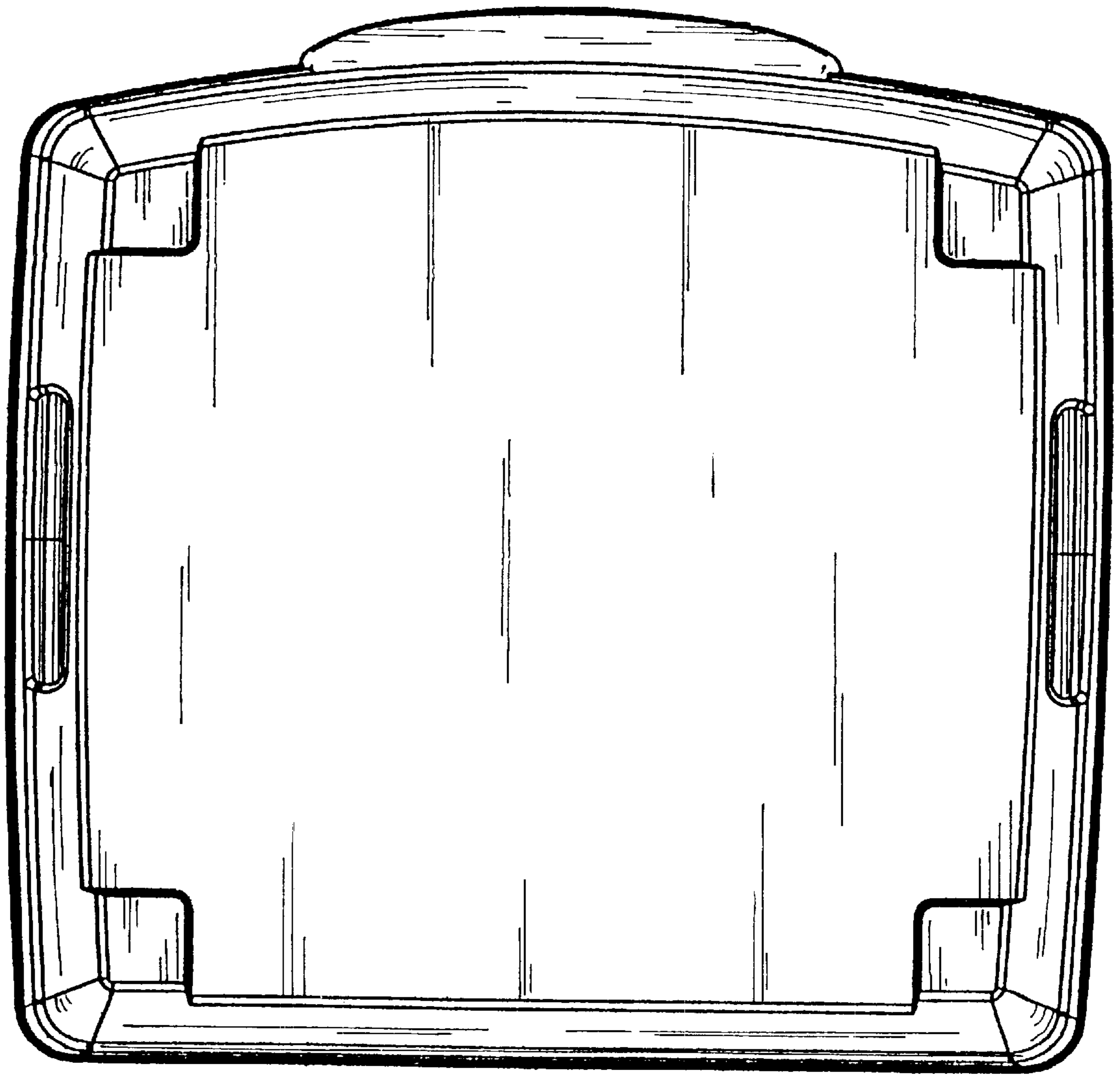

FIG. 7

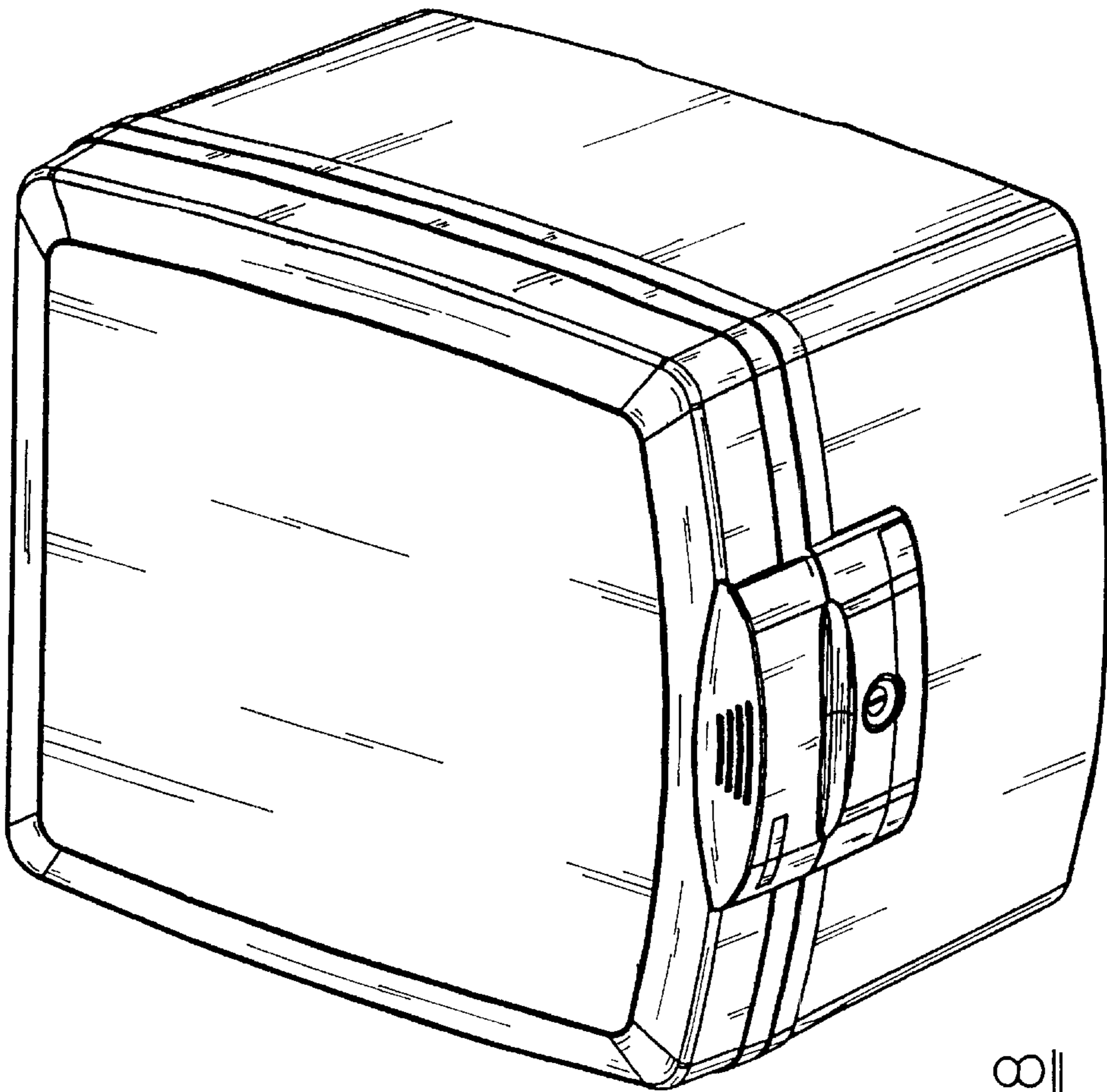

FIG. 8

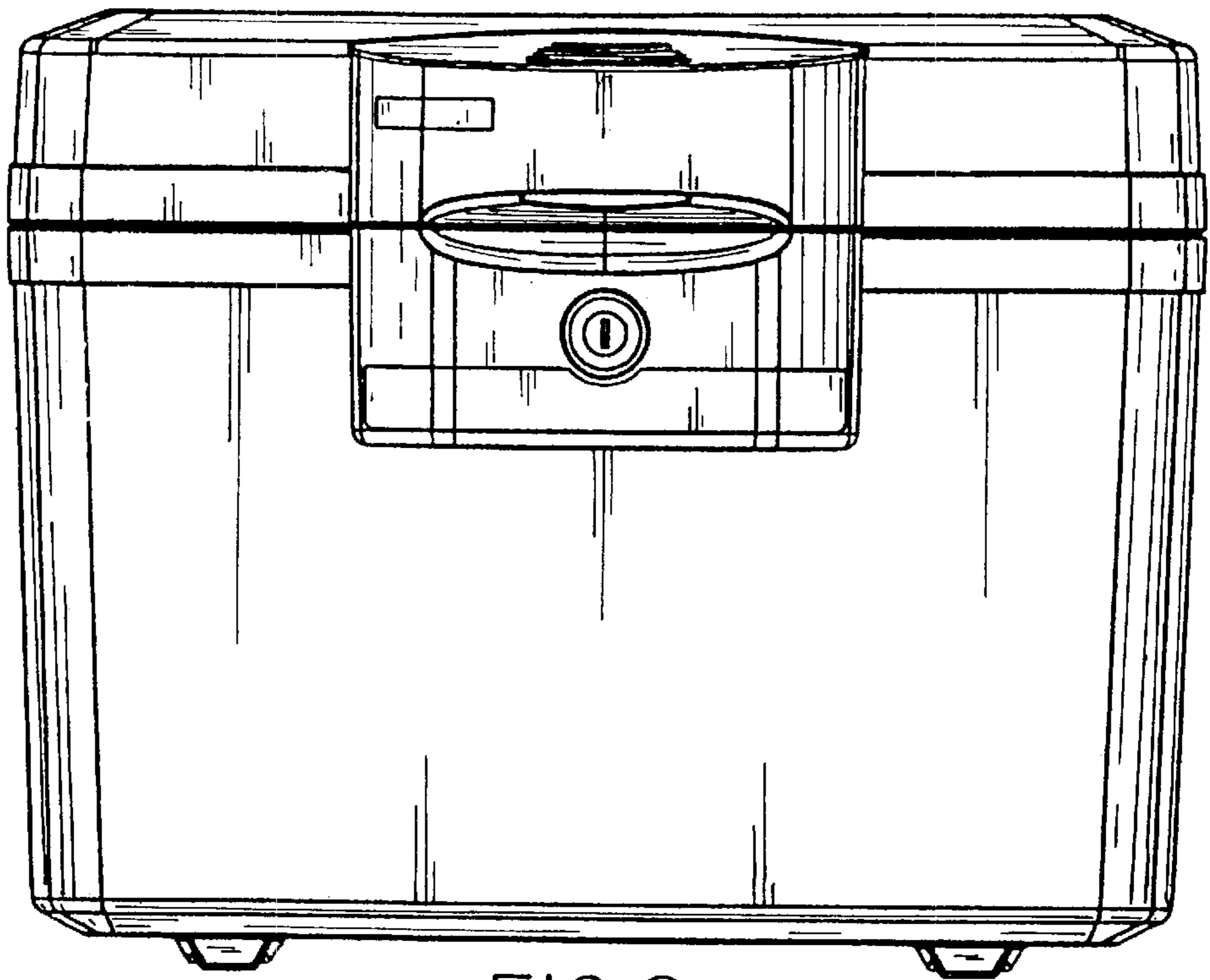

FIG. 9

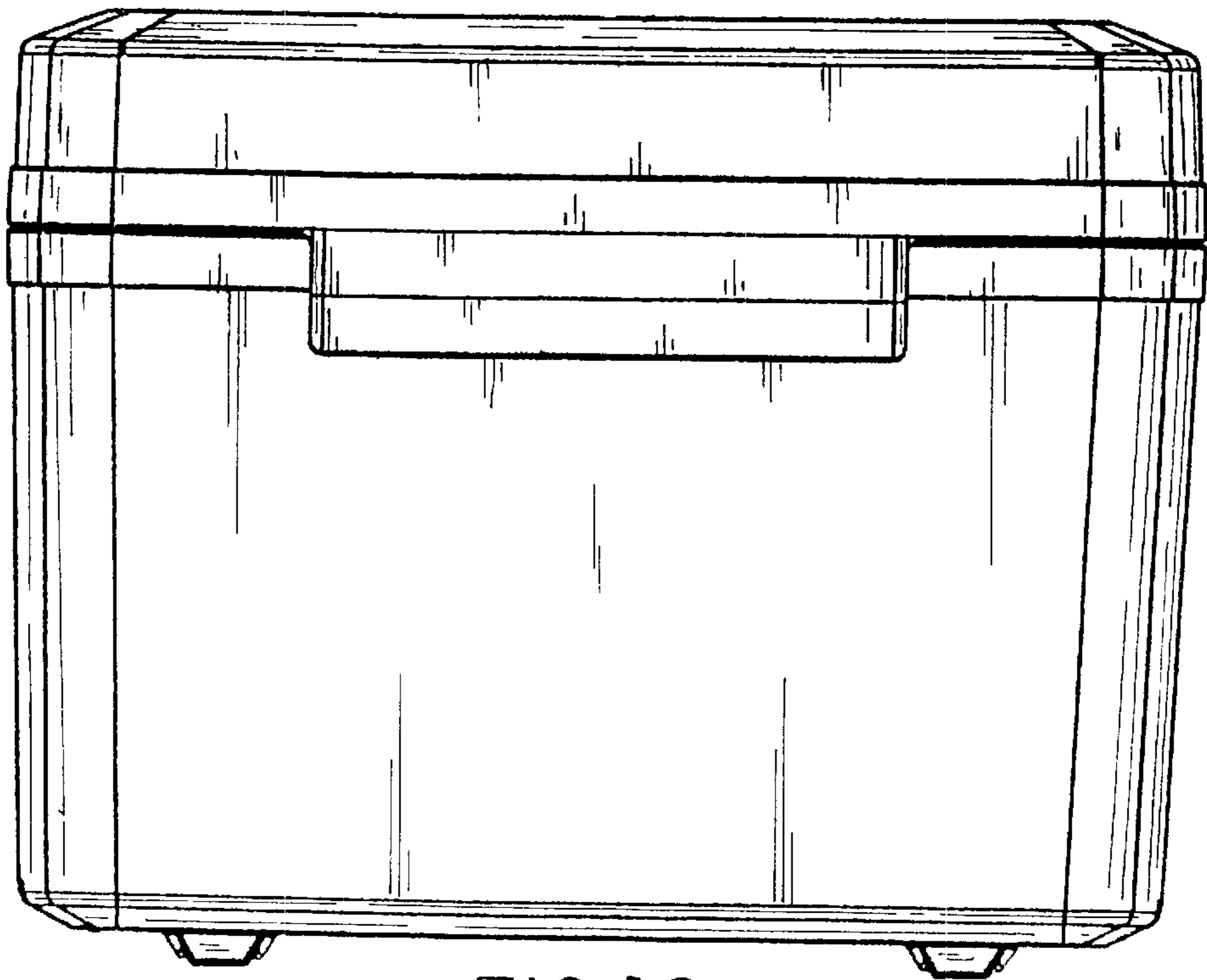

FIG. 10



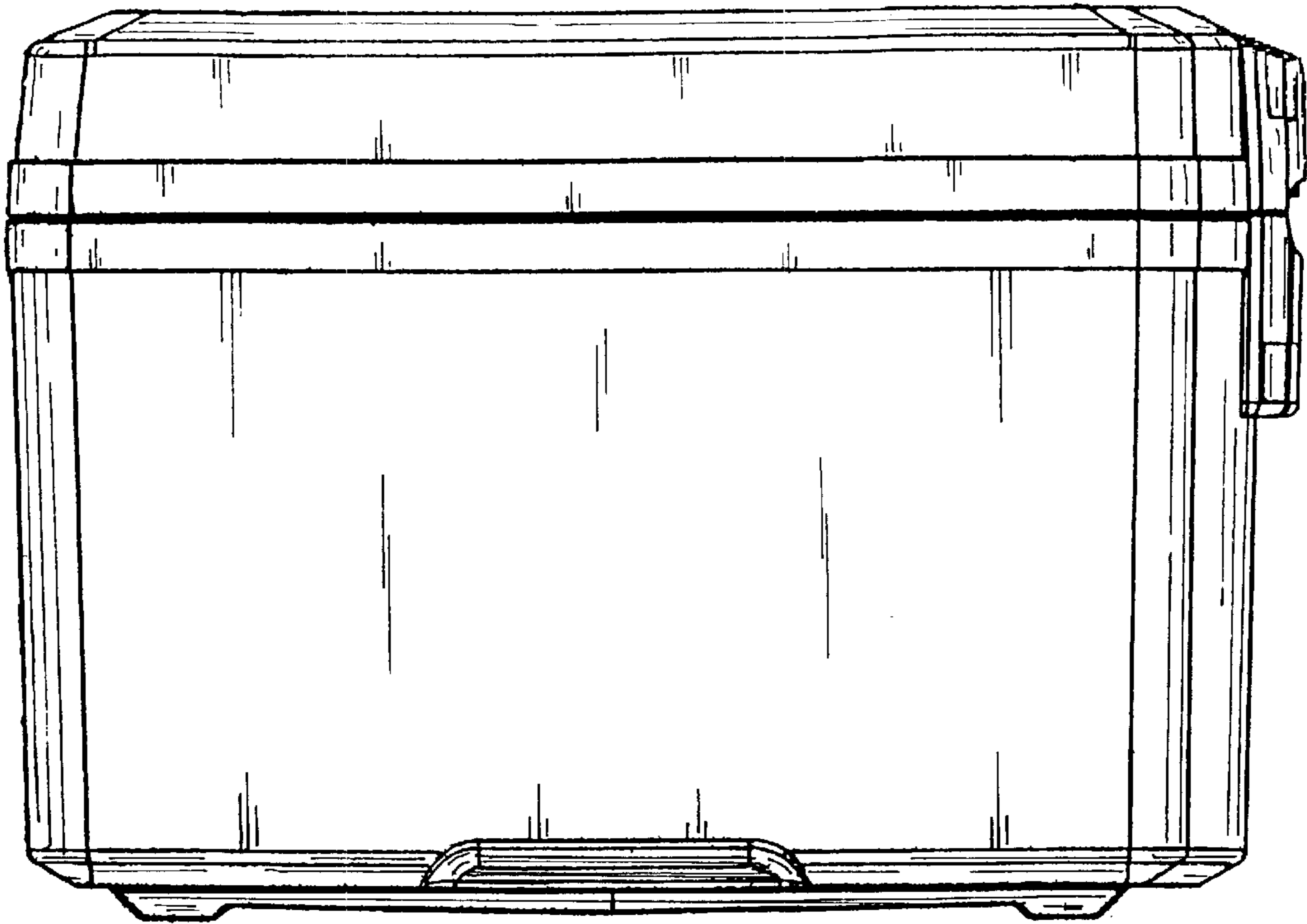

FIG. 11

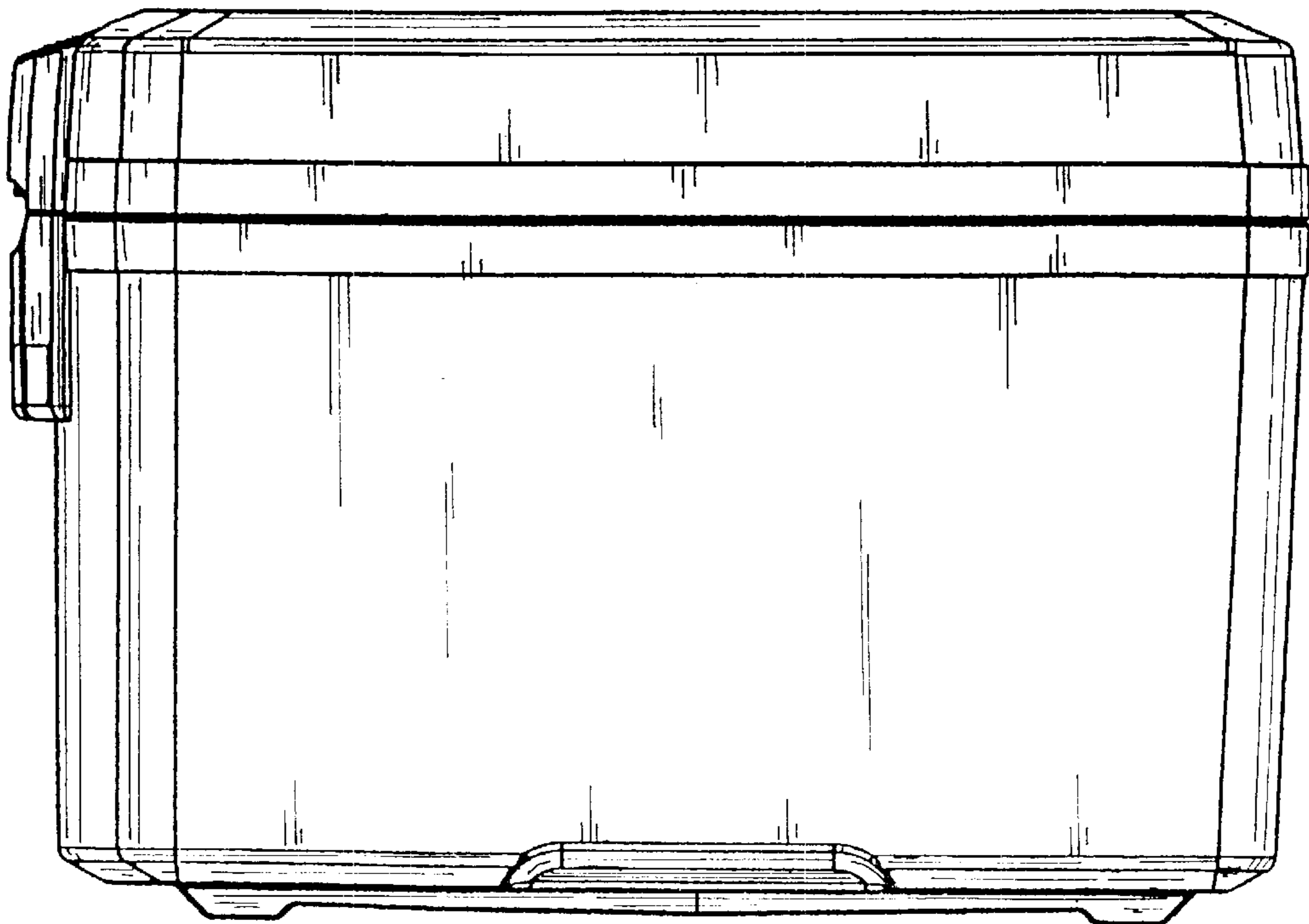

FIG. 12

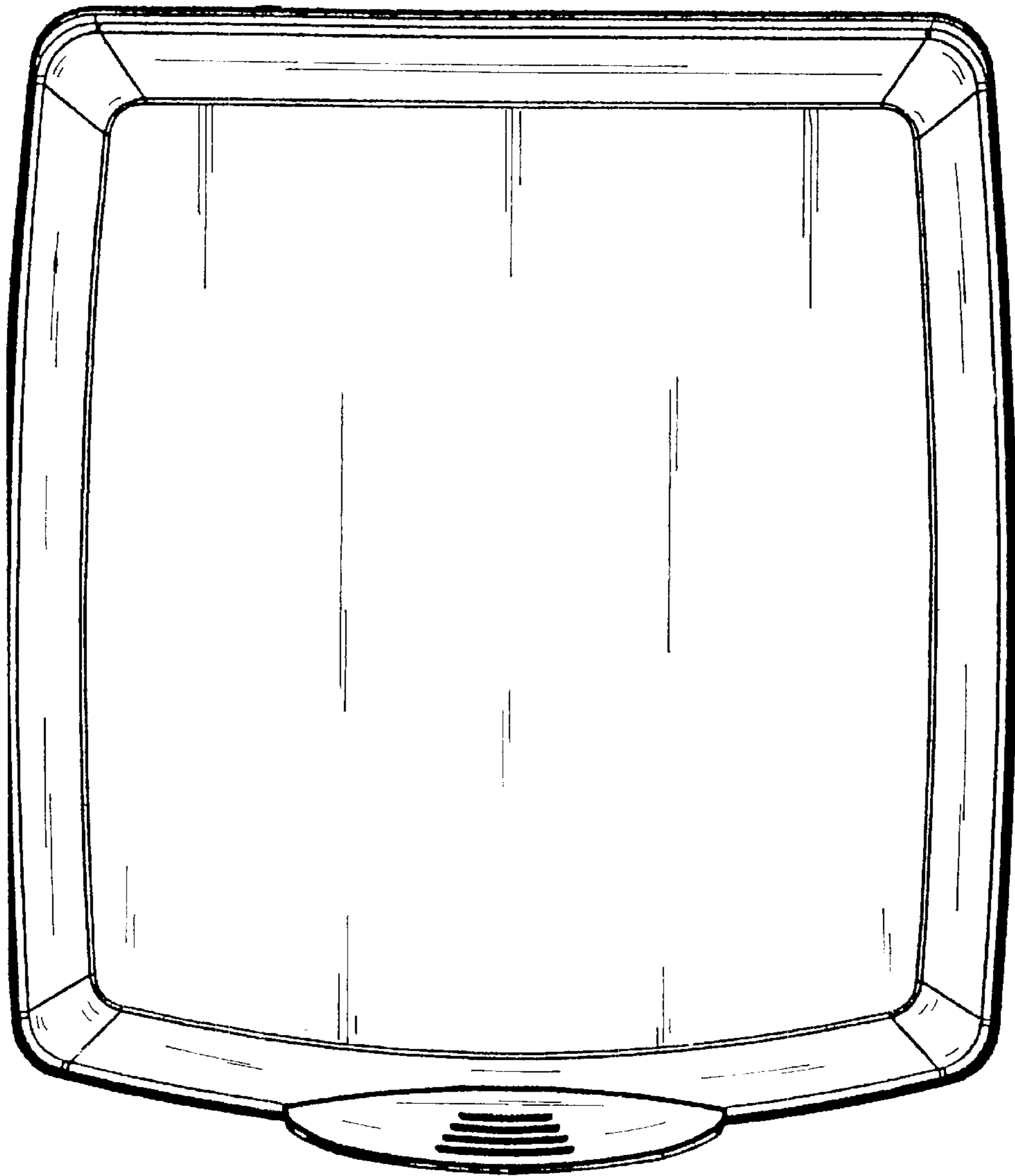

FIG. 13

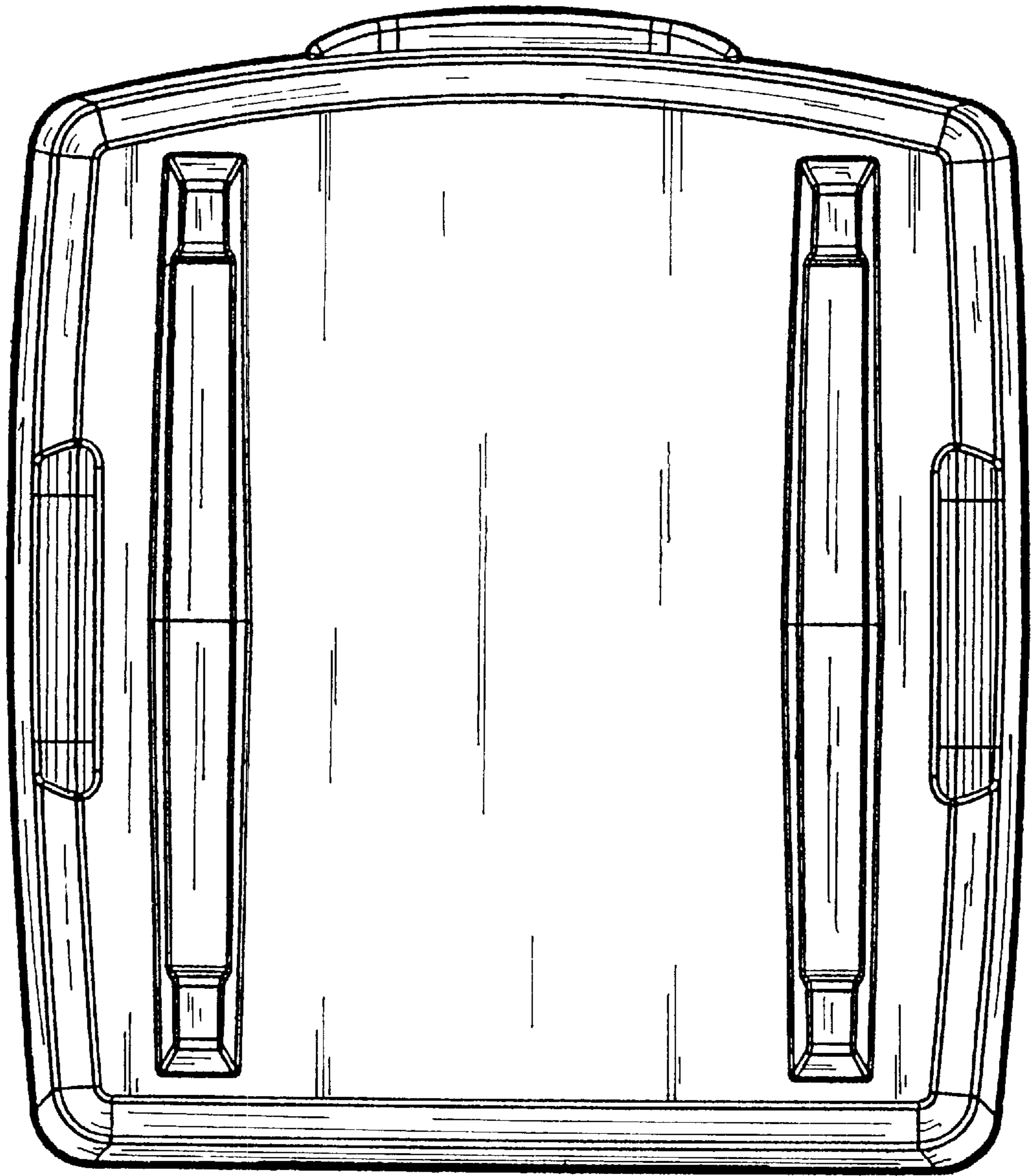

FIG. 14