



US00D474476S

(12) **United States Design Patent**  
**Chien et al.**

(10) **Patent No.:** **US D474,476 S**

(45) **Date of Patent:** **\*\* May 13, 2003**

(54) **COMPUTER FRONT BEZEL**

(75) Inventors: **Chieh Nan Chien**, Tu-Chen (TW);  
**Fu-Ming Chen**, Tu-Chen (TW); **Yin Sheng Yeh**, Tu-Chen (TW)

(73) Assignee: **Hon Hai Precision Ind. Co., Ltd.**,  
Taipei Hsien (TW)

(\*\*) Term: **14 Years**

(21) Appl. No.: **29/165,582**

(22) Filed: **Aug. 12, 2002**

(30) **Foreign Application Priority Data**

Jun. 8, 2002 (CN) ..... 02356786

(51) **LOC (7) Cl.** ..... **14-02**

(52) **U.S. Cl.** ..... **D14/444**

(58) **Field of Search** ..... D14/441-446,  
D14/240; D6/492; D13/162, 184, 199; 174/35 GC;  
220/4.28; 312/223.2, 223.3; 360/92; 361/680-686,  
641, 724

(56) **References Cited**

**U.S. PATENT DOCUMENTS**

6,000,769 A \* 12/1999 Chen ..... 312/223.2  
D425,044 S \* 5/2000 Jean et al. .... D14/446

D440,978 S \* 4/2001 Jean et al. .... D14/444  
D453,518 S \* 2/2002 Jean et al. .... D14/444  
D454,134 S \* 3/2002 Chien et al. .... D14/444  
D459,356 S \* 6/2002 Chien et al. .... D14/441

\* cited by examiner

*Primary Examiner*—Freda Nunn

(74) *Attorney, Agent, or Firm*—Wei Te Chung

(57) **CLAIM**

The ornamental design for a computer front bezel, as shown and described.

**DESCRIPTION**

FIG. 1 is a perspective view of a computer front bezel of our new design;  
FIG. 2 is a front elevational view thereof;  
FIG. 3 is a rear elevational view thereof;  
FIG. 4 is a left side elevational view thereof;  
FIG. 5 is a right side elevational view thereof;  
FIG. 6 is a top plan view thereof;  
FIG. 7 is a bottom plan view thereof; and,  
FIG. 8 is a view similar to FIG. 1 with the computer front bezel being mounted to a computer case which is shown in broken lines for illustrative purposes only and forms no part of the claimed design.

**1 Claim, 6 Drawing Sheets**

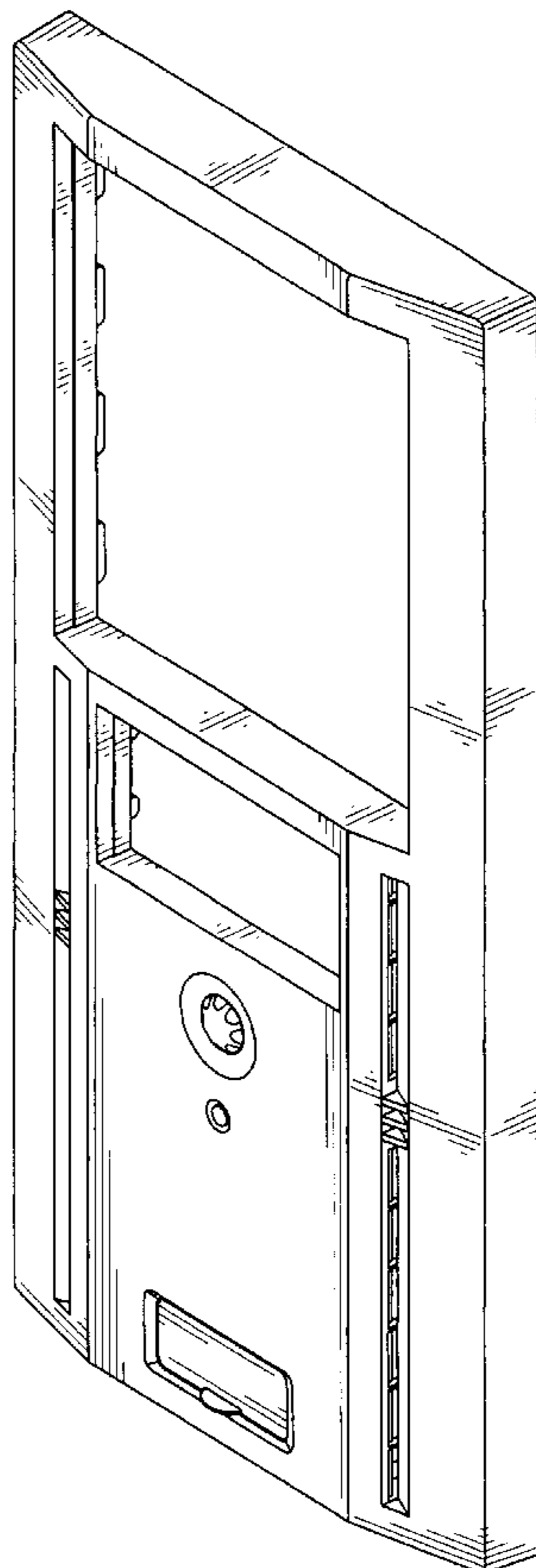

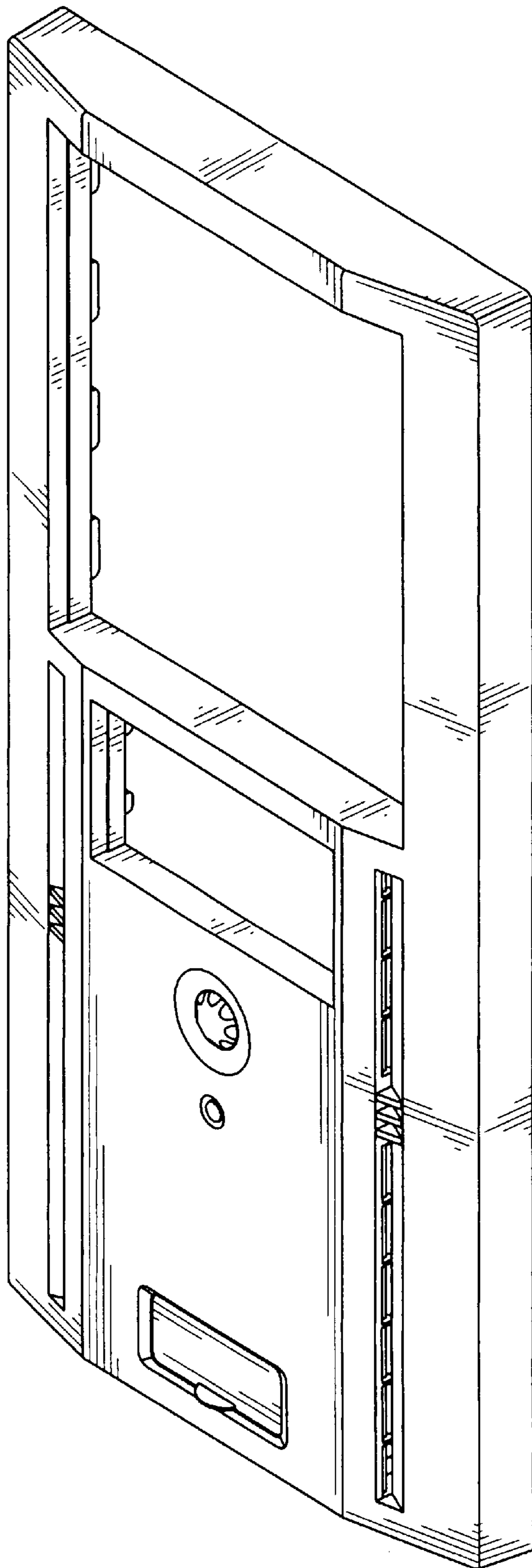

FIG. 1

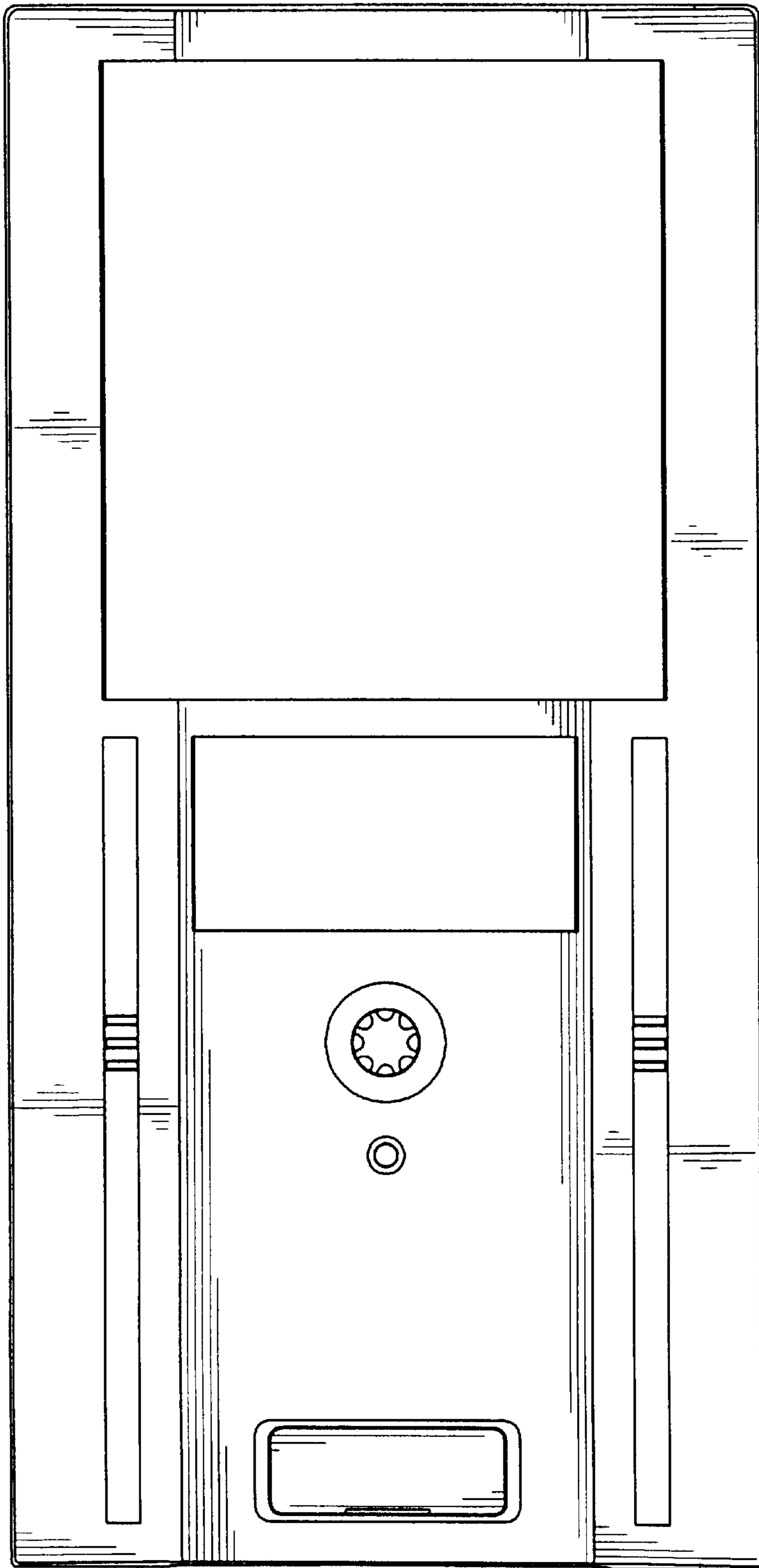

FIG. 2

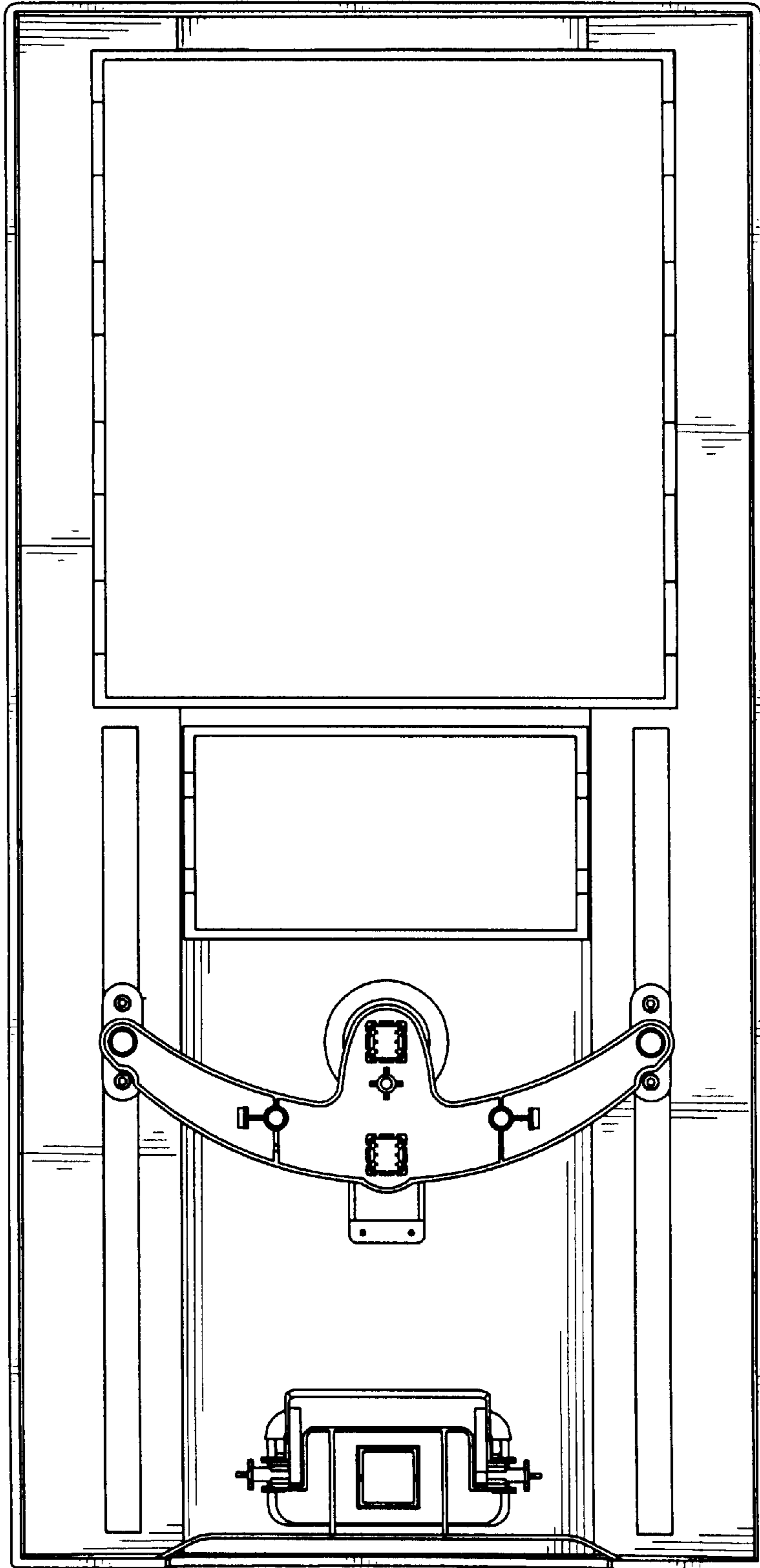

FIG. 3

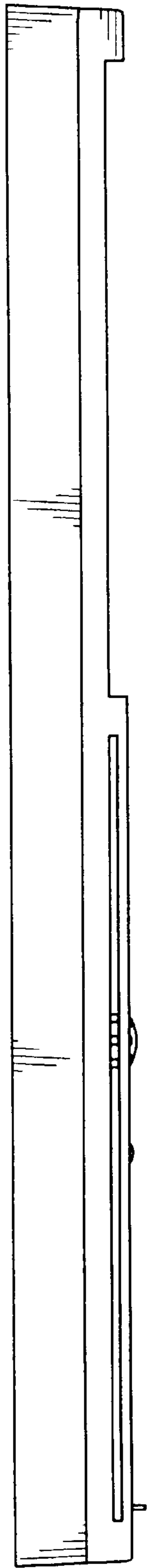

FIG. 4

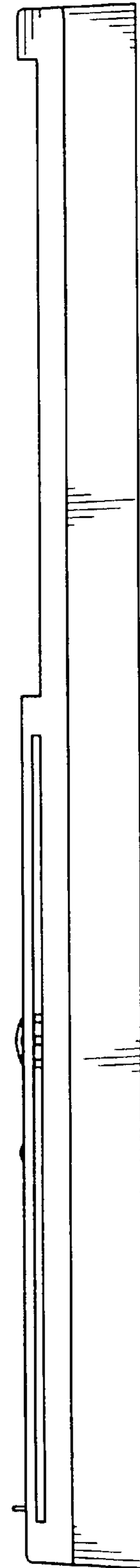

FIG. 5

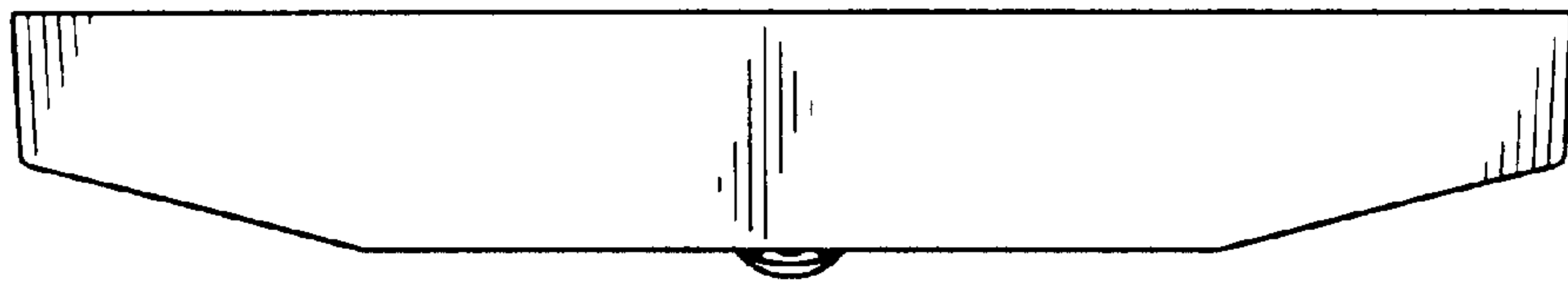

FIG. 6

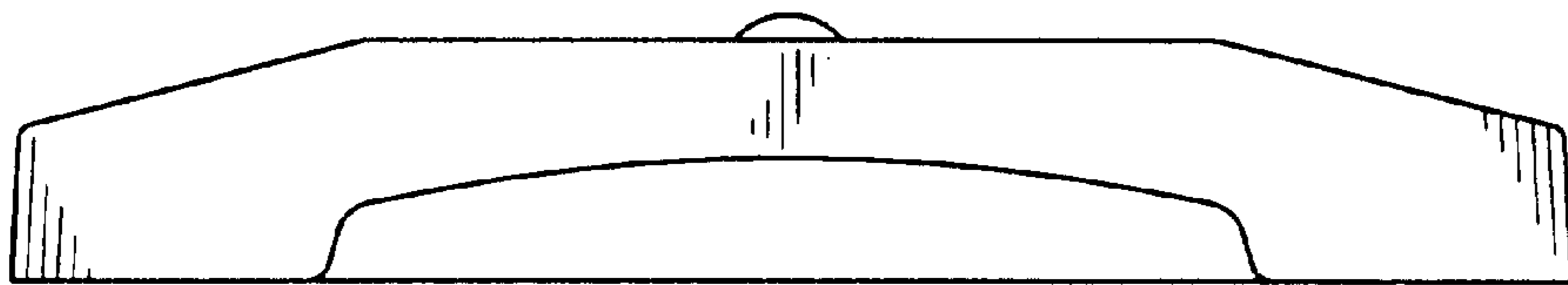

FIG. 7

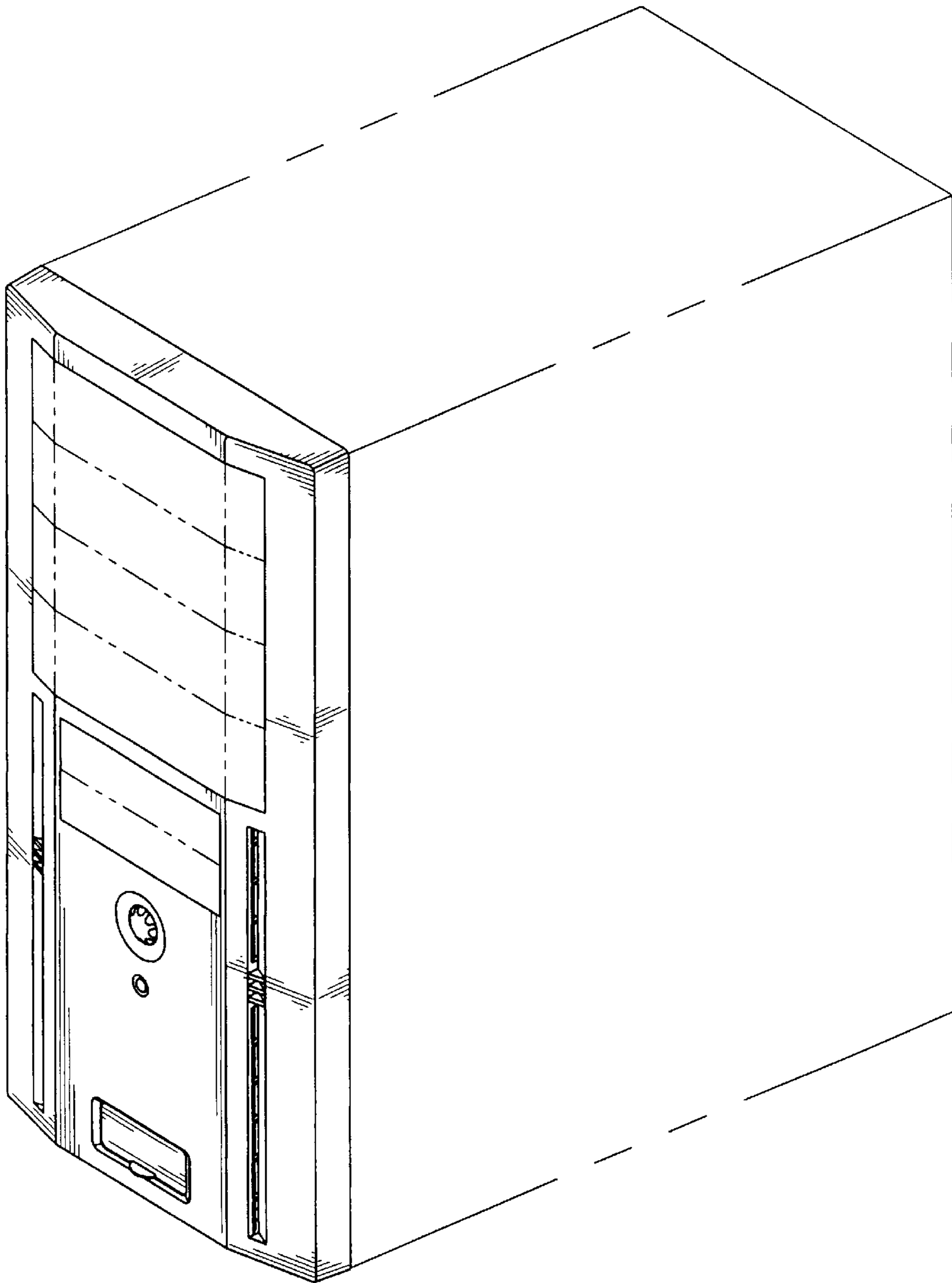

FIG. 8