



US00D474456S

(12) **United States Design Patent**
Rupe

(10) **Patent No.:** **US D474,456 S**

(45) **Date of Patent:** **** May 13, 2003**

(54) **ROOF MOUNTED HOUSING FOR AN IN-VEHICLE VIDEO RECORDER SYSTEM**

(76) Inventor: **Steven M. Rupe**, 3666 Park Ave. West,
P.O. Box 63, Ontario, OH (US) 44862

(**) Term: **14 Years**

(21) Appl. No.: **29/157,345**

(22) Filed: **Mar. 18, 2002**

(51) **LOC (7) Cl.** **14-01**

(52) **U.S. Cl.** **D14/167**

(58) **Field of Search** D12/132, 418;
D14/156-157, 167-168, 188-189, 207,
258, 260, 299; 180/90; 296/24.1, 37.1,
37.7, 37.8

(56) **References Cited**

U.S. PATENT DOCUMENTS

D260,507 S	*	9/1981	Kosugi et al.	D12/418
D297,527 S	*	9/1988	Iacovelli	D12/418
4,789,904 A		12/1988	Peterson		
4,949,186 A		8/1990	Peterson		
5,469,298 A	*	11/1995	Suman et al.	296/37.7
D413,856 S	*	9/1999	Scribner	D12/418
6,333,759 B1		12/2001	Mazzilli		
D455,130 S		4/2002	Skaff et al.		

* cited by examiner

Primary Examiner—Nanda Bondade

(74) *Attorney, Agent, or Firm*—Taft, Stettinius & Hollister
LLP

(57) **CLAIM**

I claim the ornamental design for a roof mounted housing for an in-vehicle video recorder system, as shown and described.

DESCRIPTION

FIG. 1 is a perspective bottom view of a roof mounted housing for an in-vehicle video recorder system, showing my new design;

FIG. 2 is a left side environmental view thereof;

FIG. 3 is a bottom plan view thereof;

FIG. 4 is a right side elevational view thereof;

FIG. 5 is a left side elevational view thereof;

FIG. 6 is a rear elevational view thereof; and,

FIG. 7 is a front elevational view thereof.

FIG. 2 is on a reduced scale.

The broken lines showing the light fixture or a portion of the light fixture in FIGS. 1-7 and the environmental structure on FIG. 2 are for illustrative purposes only and form no part of the claimed design.

1 Claim, 7 Drawing Sheets

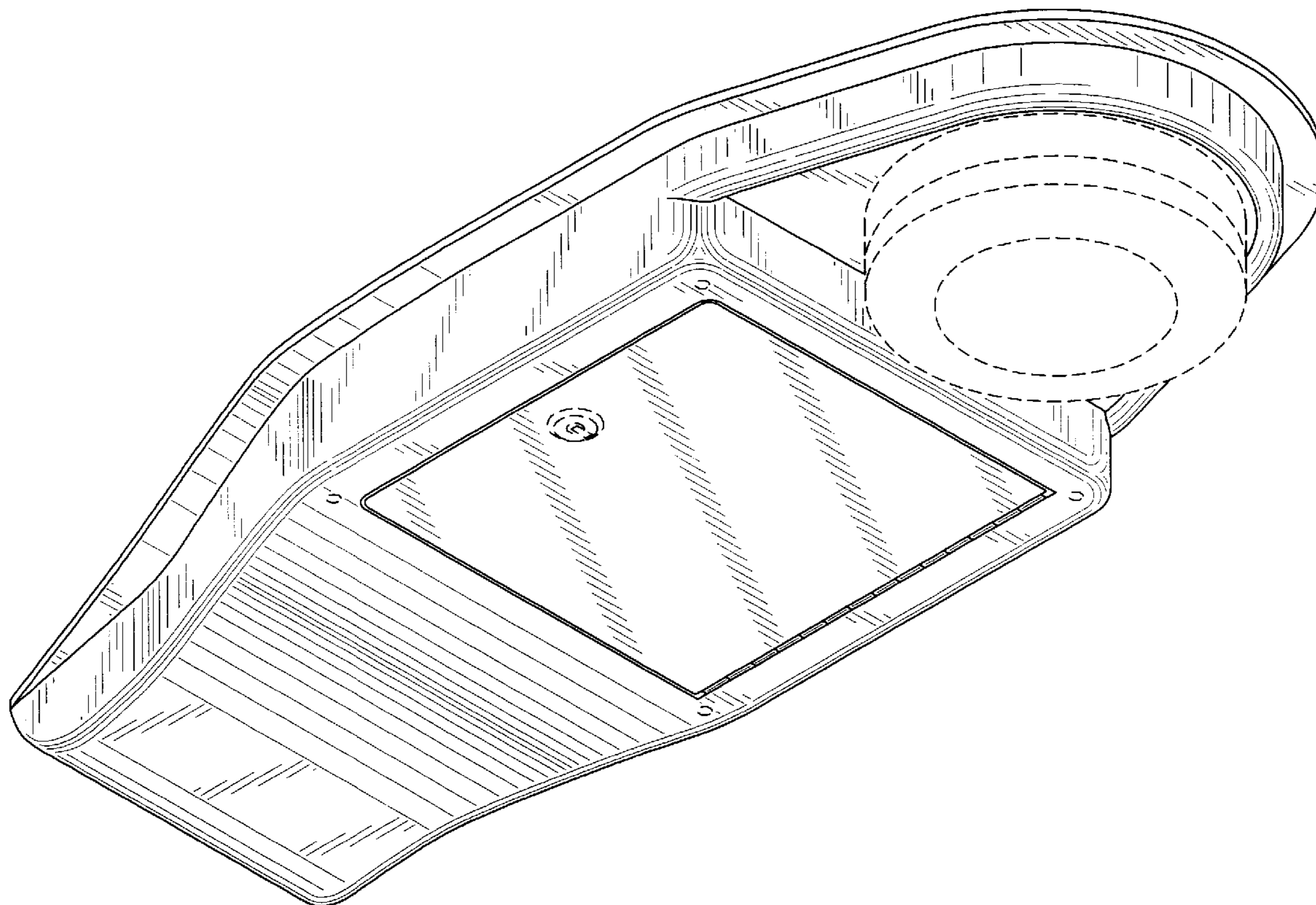

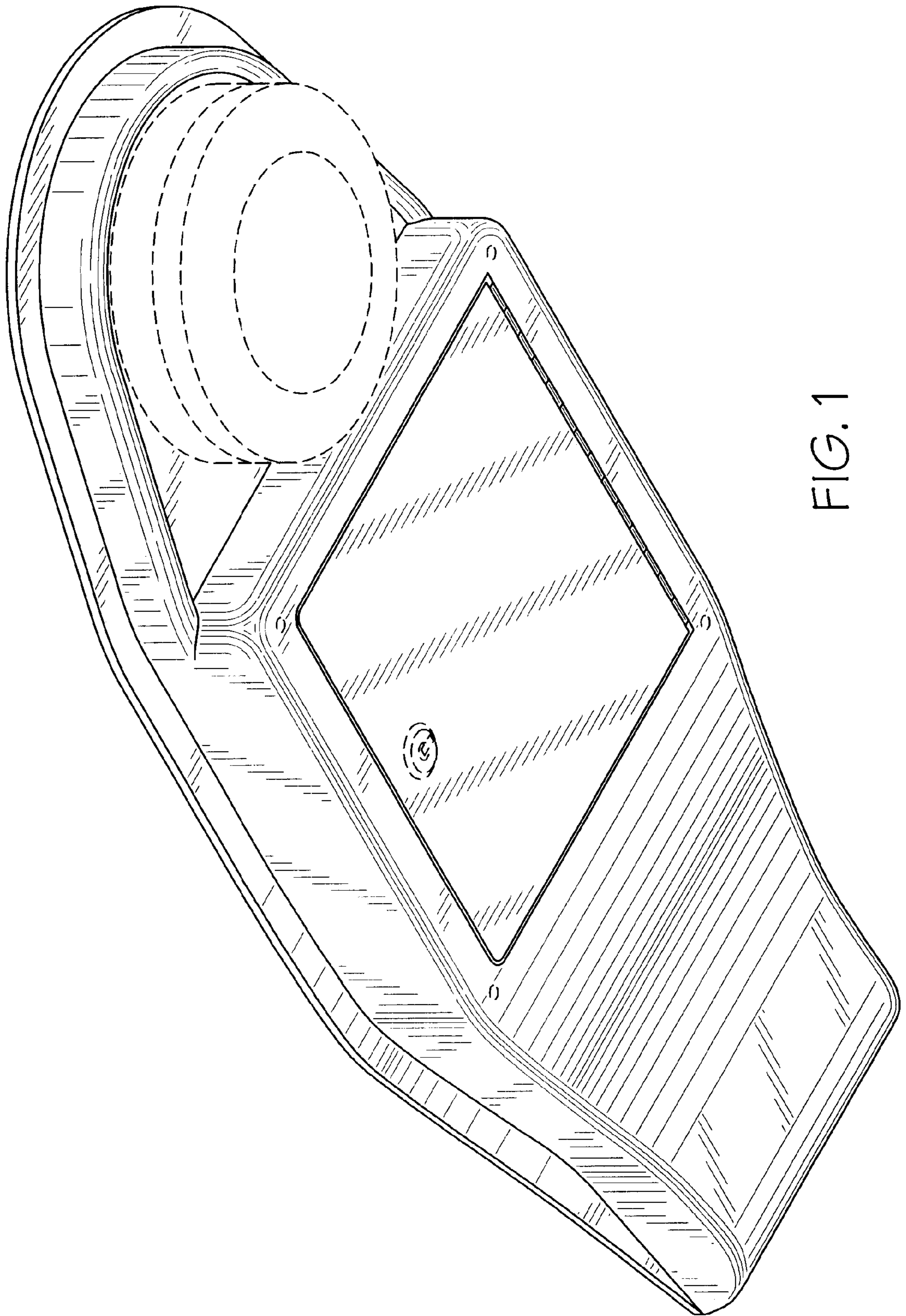

FIG. 1

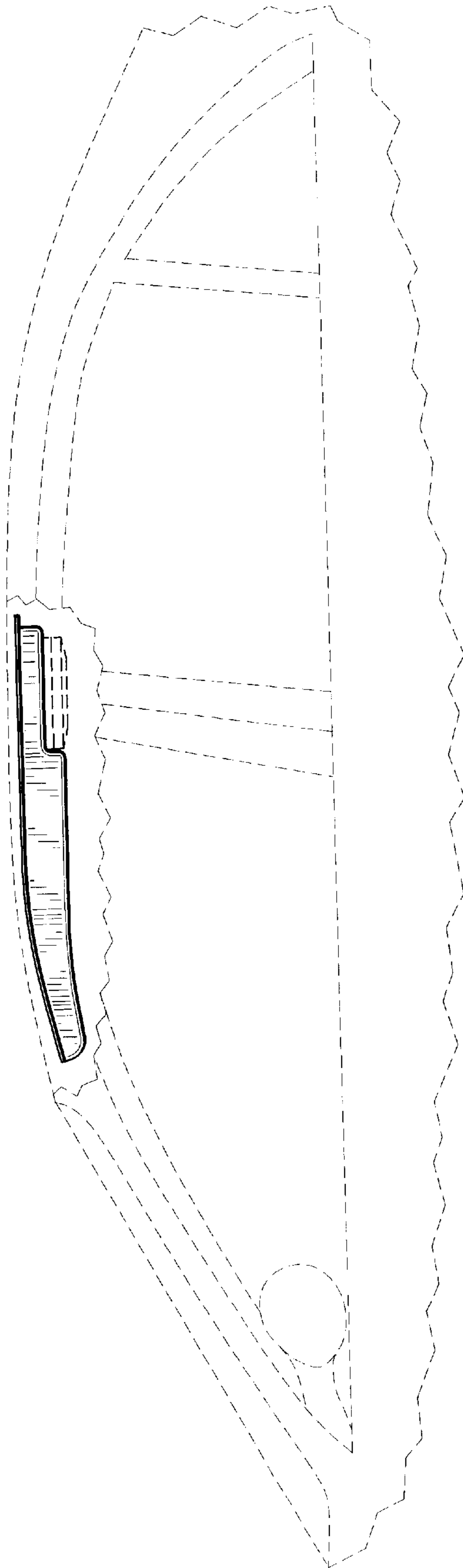

FIG. 2

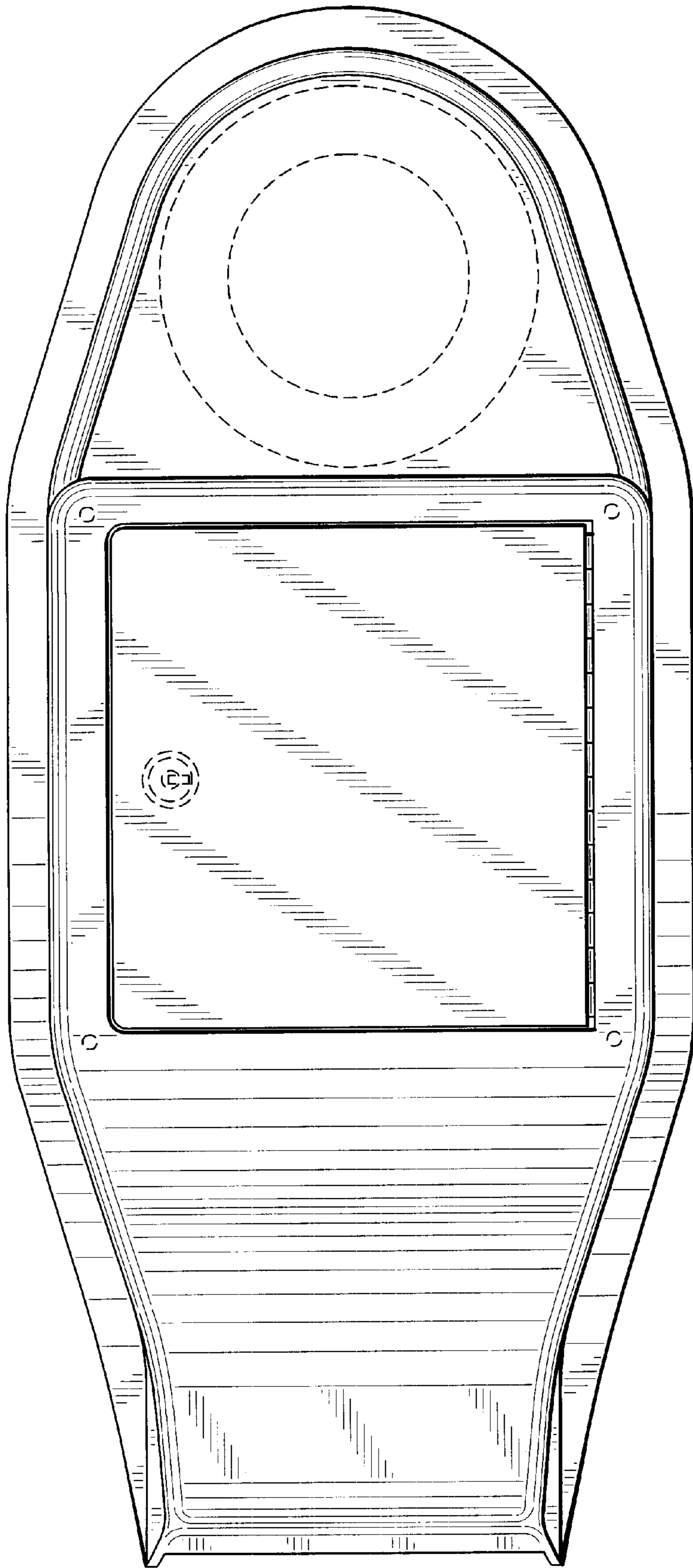

FIG. 3

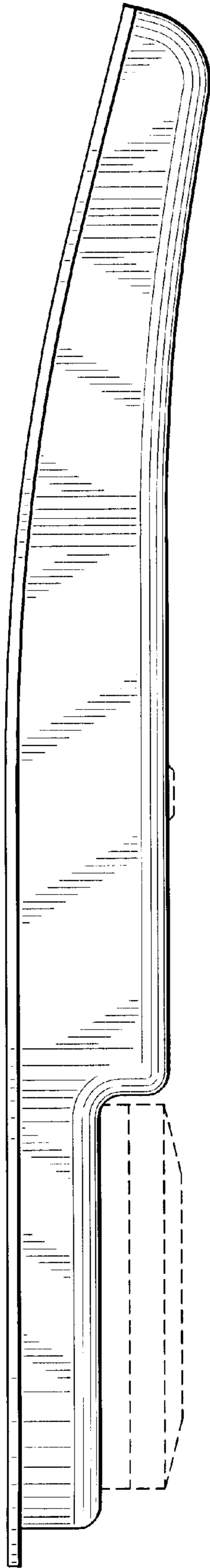

FIG. 4

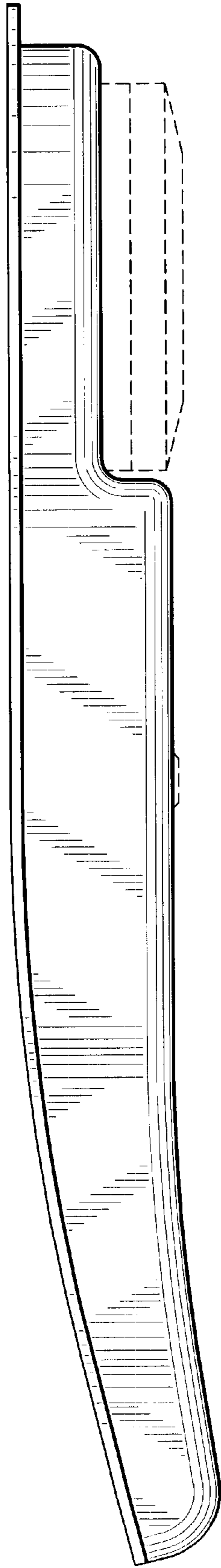

FIG. 5

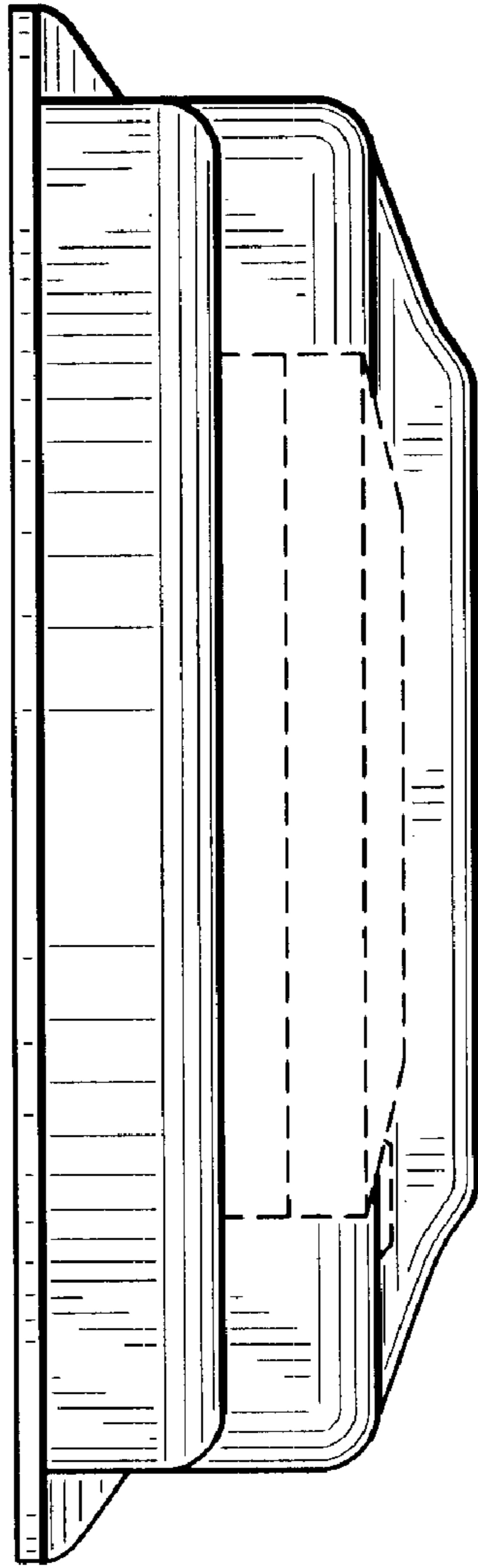

FIG. 6

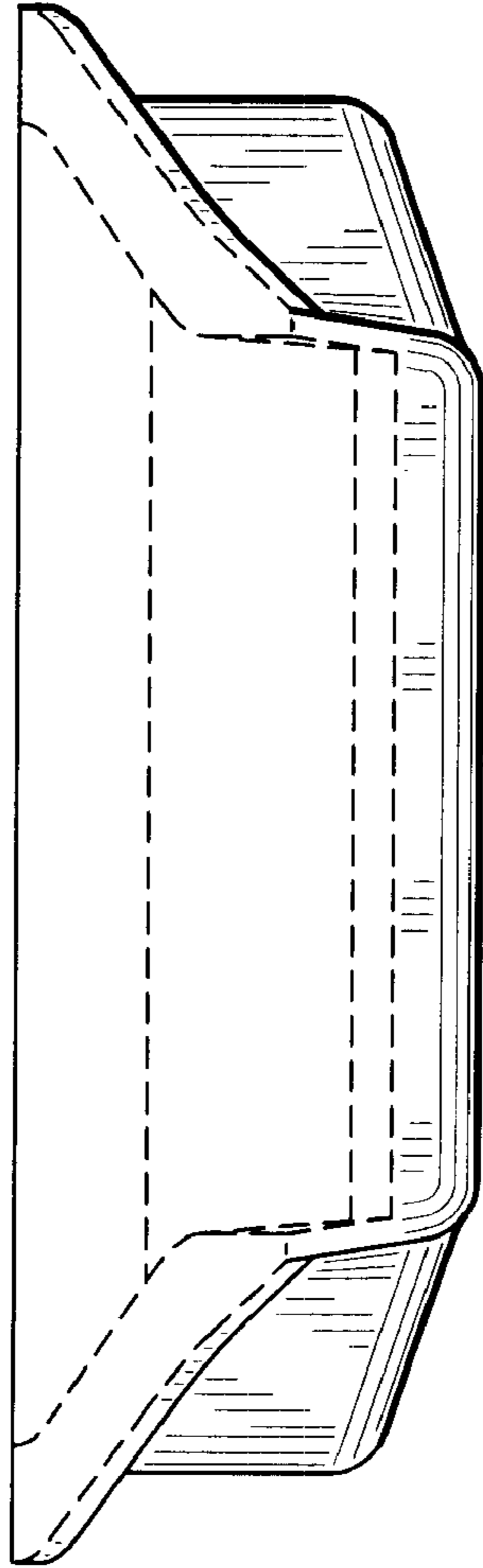

FIG. 7