



US00D474361S

(12) **United States Design Patent**
Ancona

(10) **Patent No.:** **US D474,361 S**

(45) **Date of Patent:** **** May 13, 2003**

(54) **PAPER TOWEL HOLDER**

6,302,348 B1 * 10/2001 Lillelund et al. 242/597.7 X
D459,929 S * 7/2002 Snell D6/521

(75) Inventor: **Bruce Ancona**, New York, NY (US)

* cited by examiner

(73) Assignee: **J.P. Products, L.L.C.**, New York, NY (US)

Primary Examiner—Brian N. Vinson
(74) *Attorney, Agent, or Firm*—Shughart Thomson & Kilroy, P.C.; Gerald M. Kraai

(**) Term: **14 Years**

(21) Appl. No.: **29/171,362**

(57) **CLAIM**

(22) Filed: **Nov. 21, 2002**

The ornamental design for a paper towel holder, as shown and described.

(51) **LOC (7) Cl.** **23-02**

DESCRIPTION

(52) **U.S. Cl.** **D6/522; D6/521**

FIG. 1 is a perspective view of a paper towel holder according to my invention.

(58) **Field of Search** D6/518, 521, 522,

D6/566; 222/173; 206/389; 211/16, 44, 57.1, 181.1; 242/570, 590, 596, 597; 248/175, 302, 309.2

FIG. 2 is a top plan view of the paper towel holder.

FIG. 3 is a bottom plan view of the paper towel holder.

FIG. 4 is a front view of the paper towel holder.

FIG. 5 is a rear view of the paper towel holder; and,

FIG. 6. is a right side view of the paper towel holder; the left side view of the paper towel holder is a mirror image of the right side view of the paper towel holder.

(56) **References Cited**

U.S. PATENT DOCUMENTS

- D390,054 S * 2/1998 Goodman D6/522
- D405,304 S * 2/1999 Goodman et al. D6/522
- D412,803 S * 8/1999 Goodman et al. D6/521

1 Claim, 6 Drawing Sheets

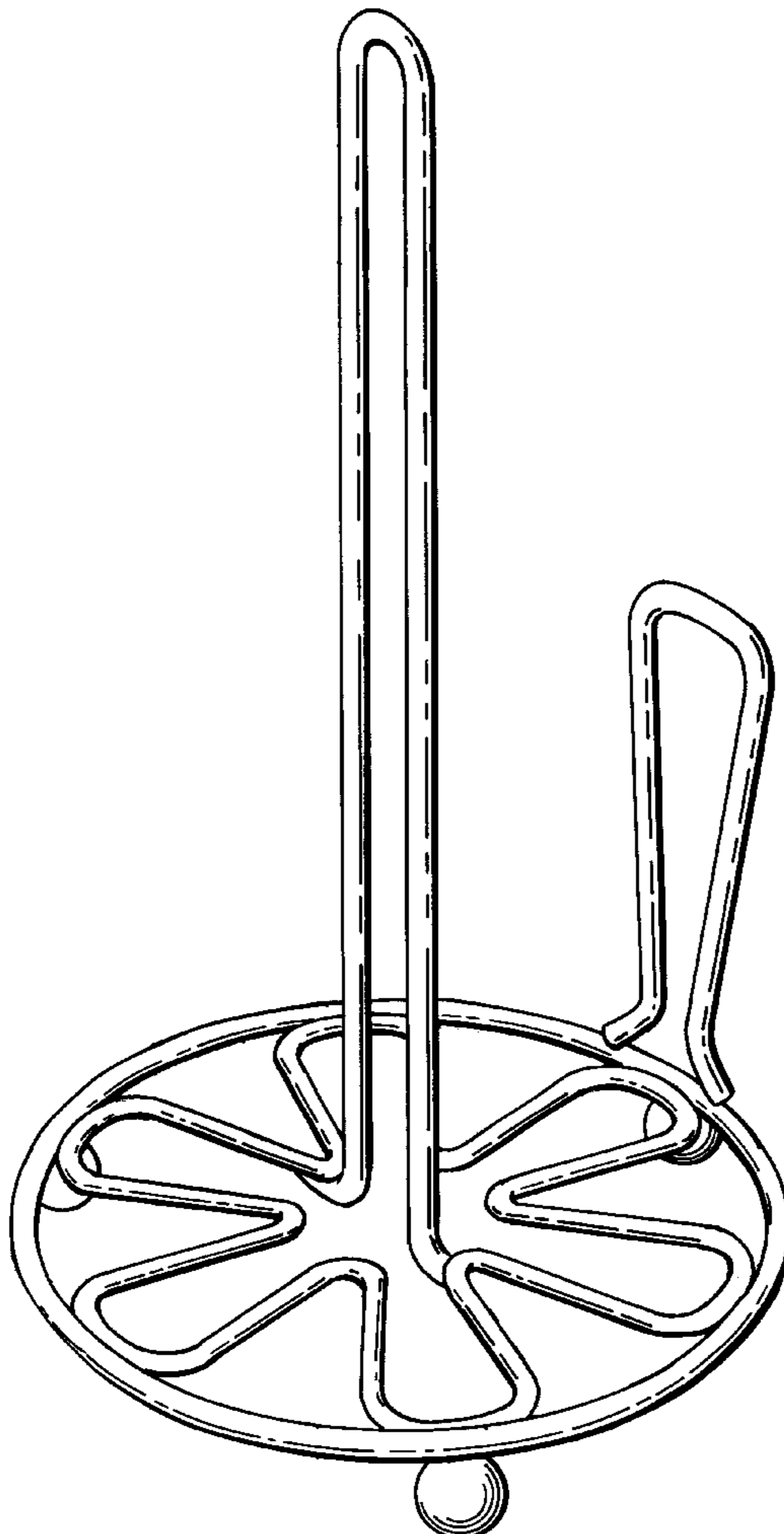
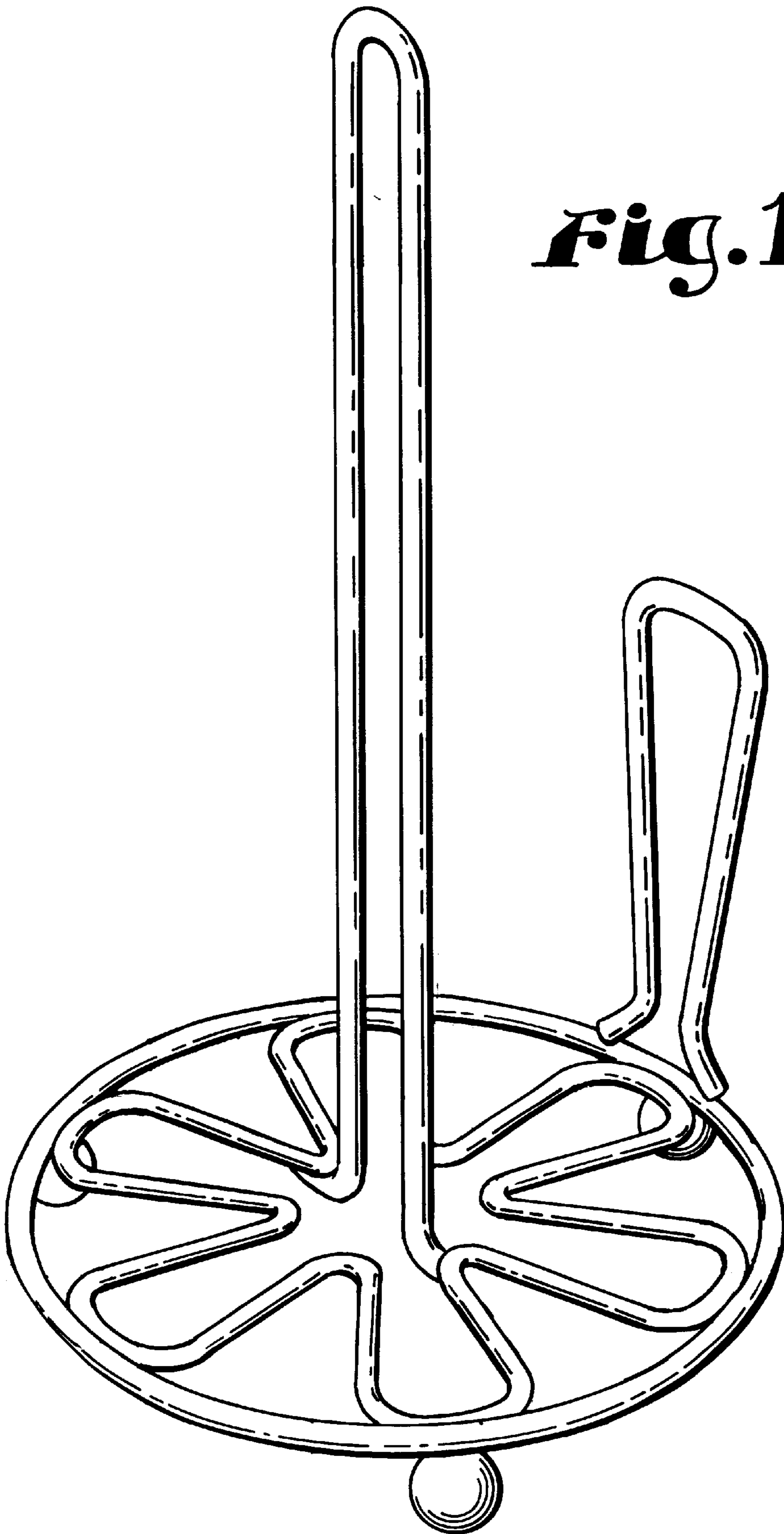

Fig. 1.



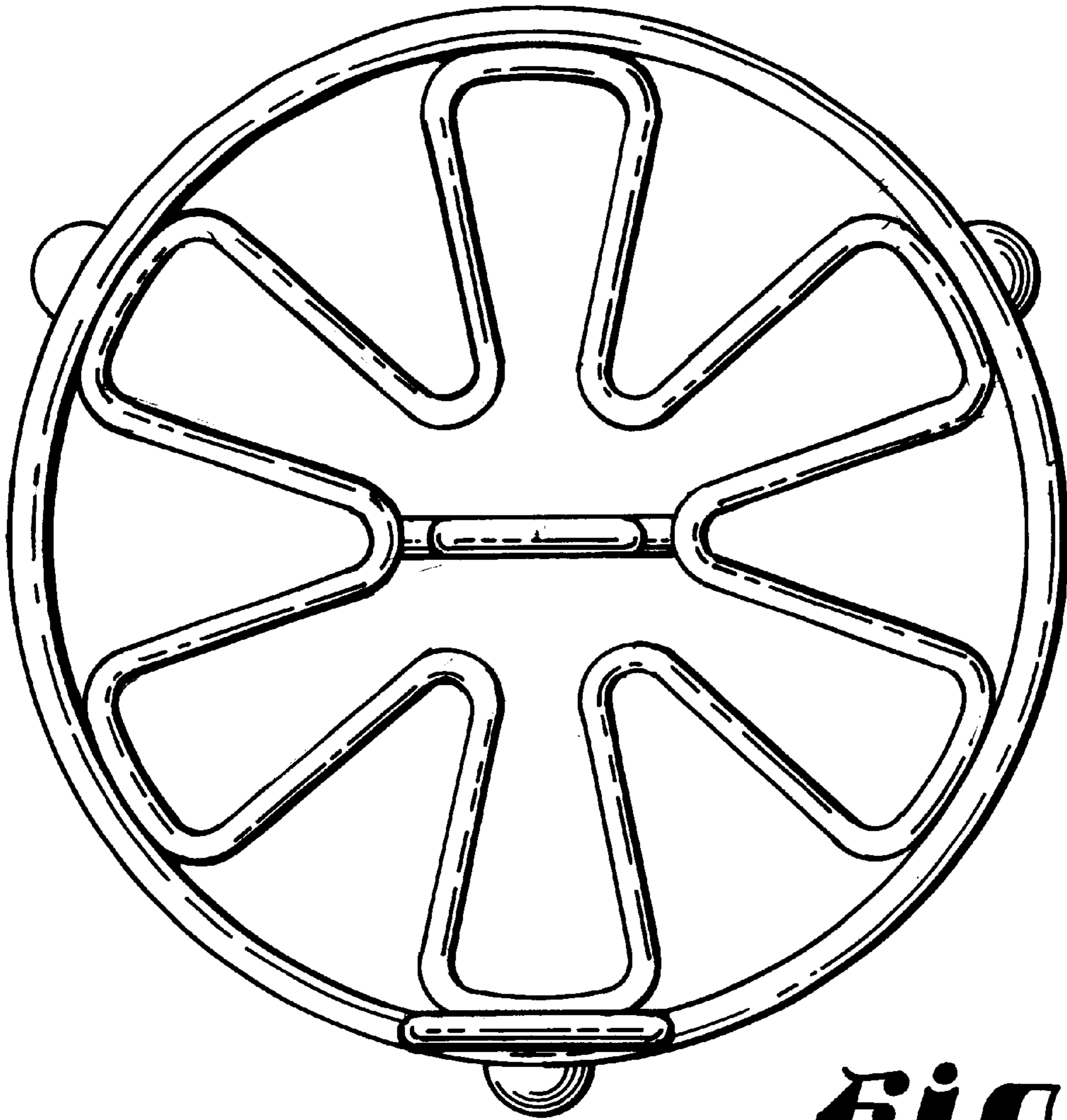
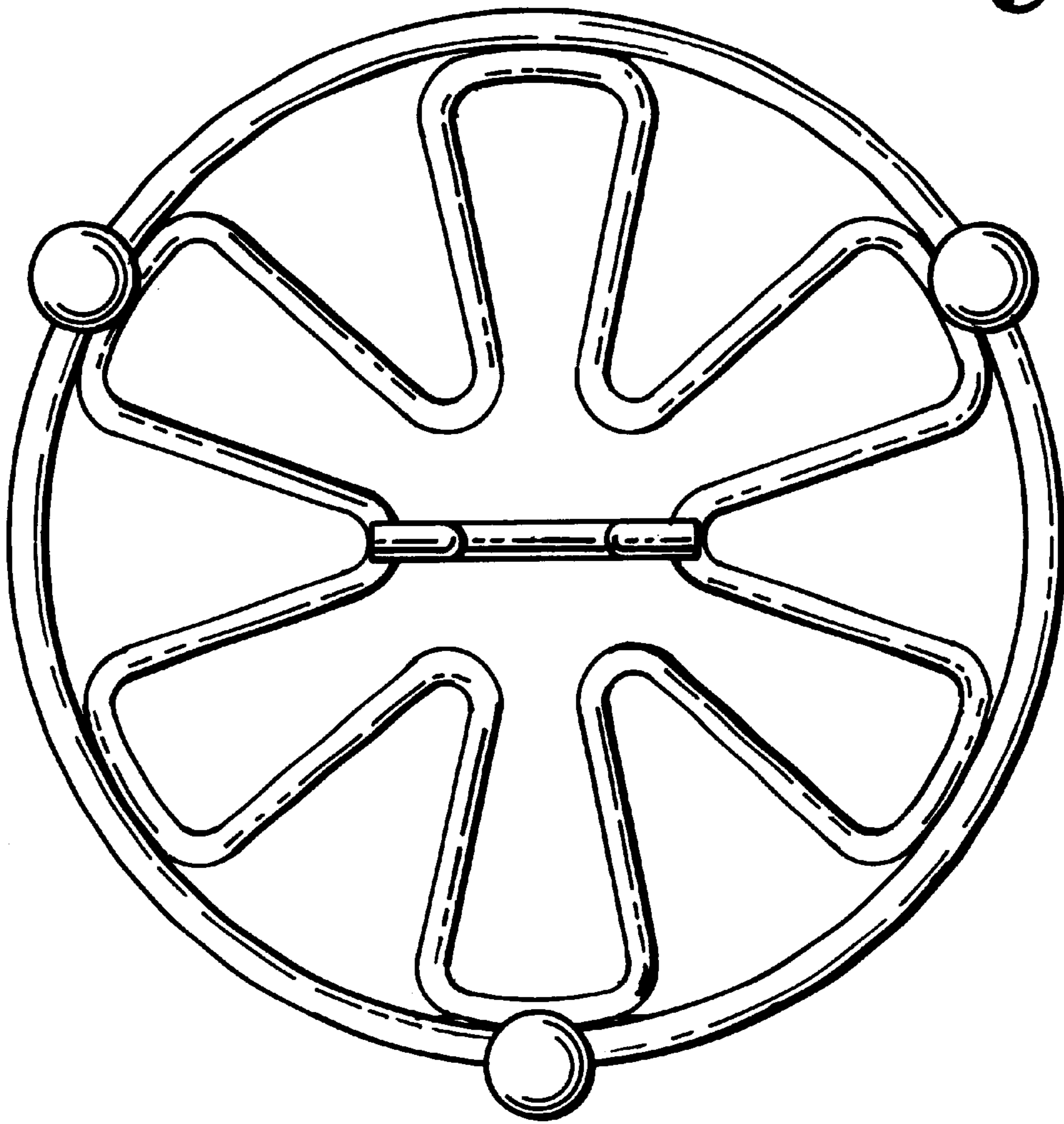

Fig. 2.

Fig. 3.



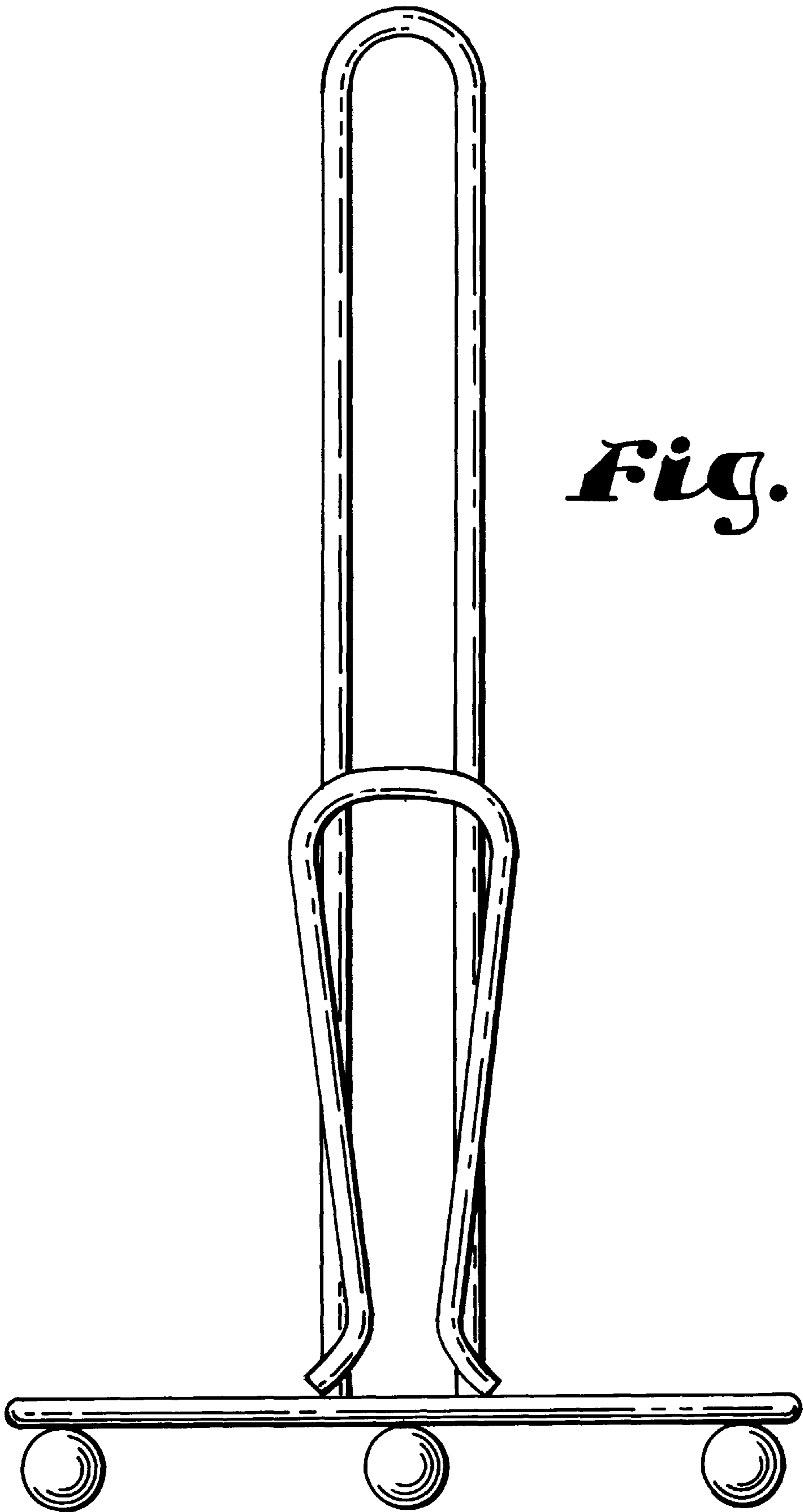

Fig. 4.

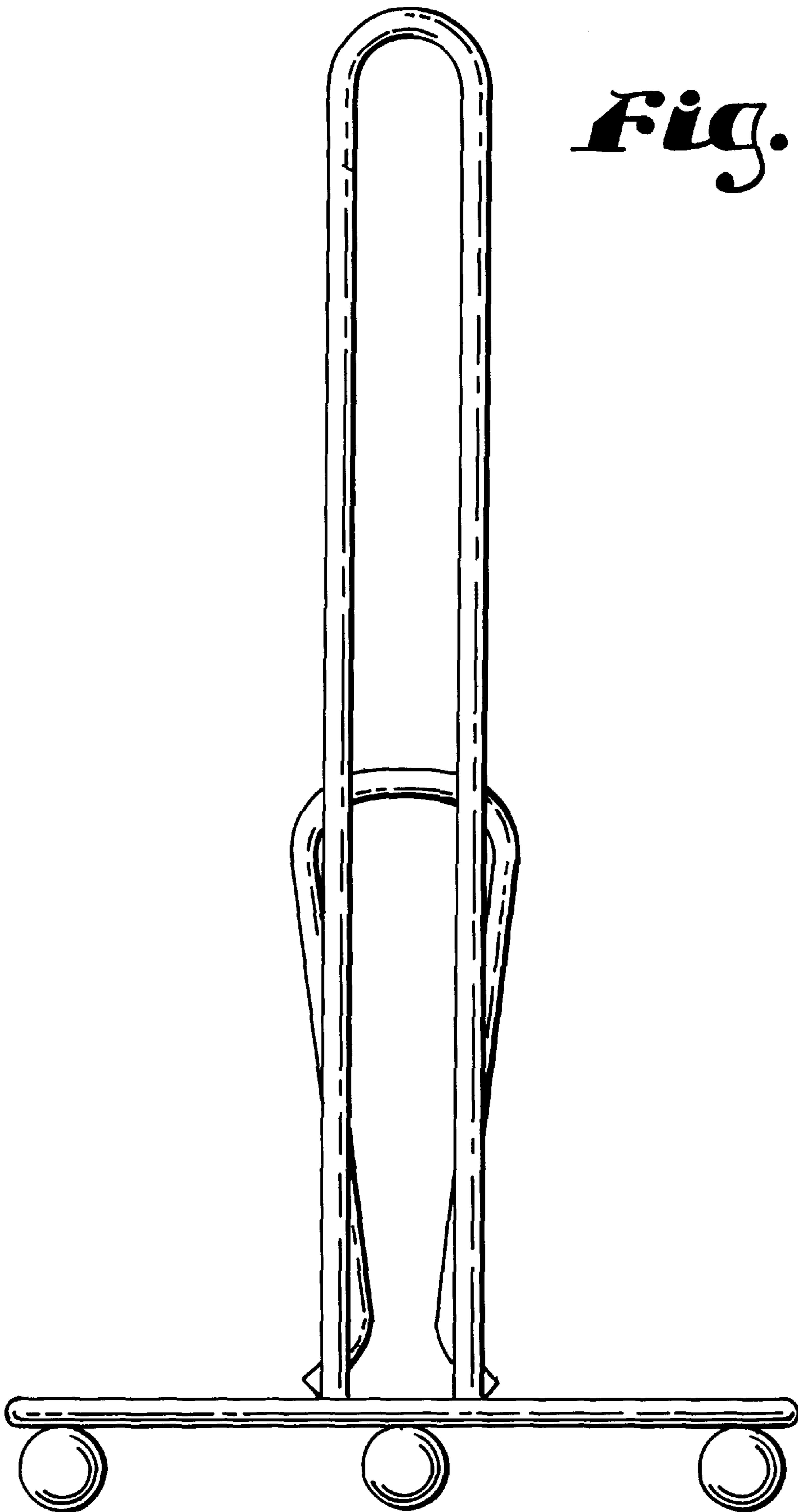

Fig. 5.

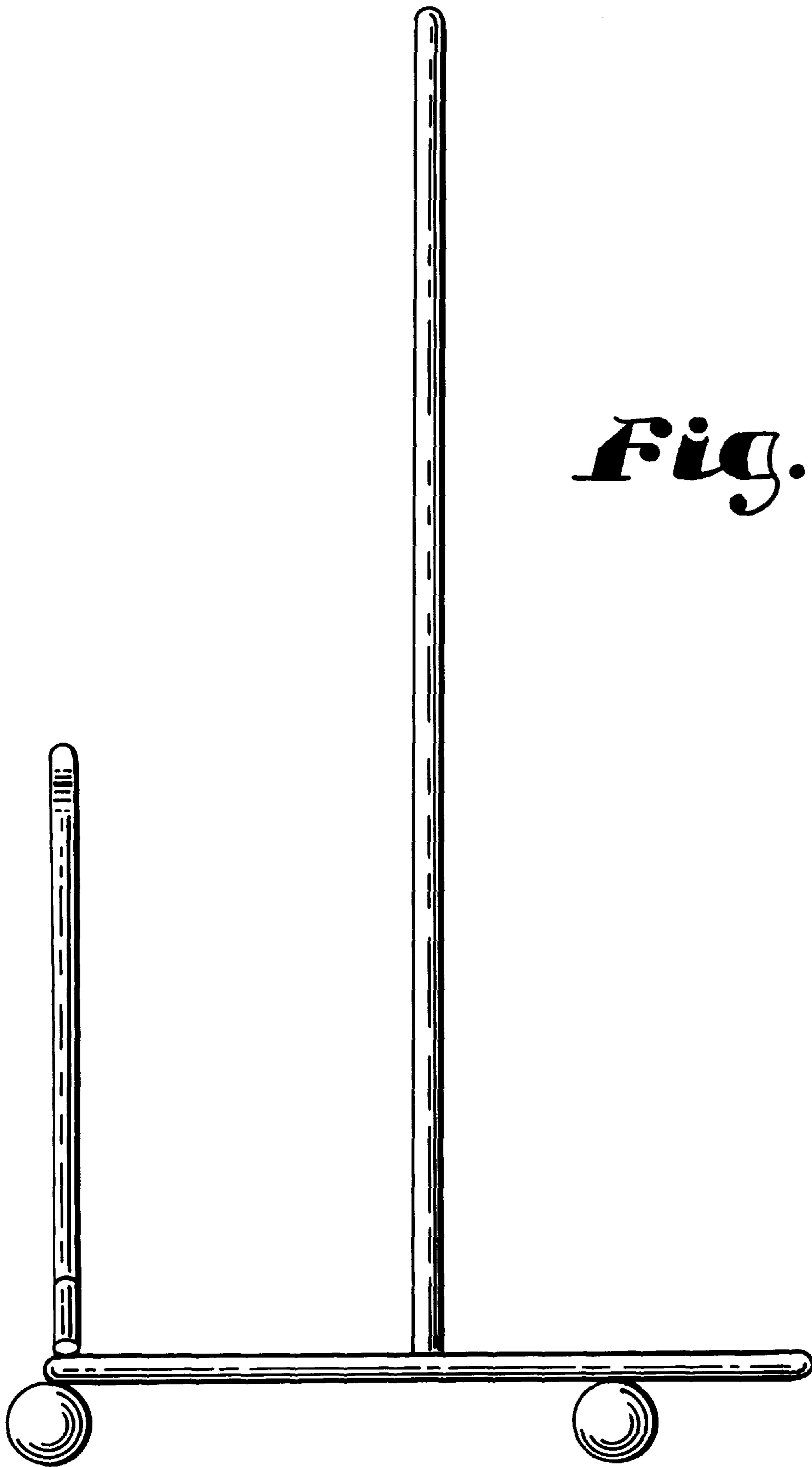

Fig. 6.