



US00D474360S

(12) **United States Design Patent**
Yip

(10) **Patent No.:** **US D474,360 S**

(45) **Date of Patent:** **** May 13, 2003**

(54) **PAPER ROLL STAND**

D298,597 S * 11/1988 Bell D6/521
5,938,141 A * 8/1999 Kanbar 242/597.7 X

(76) Inventor: **Chung Lun Yip**, 3rd Floor, Block
A&C, King Yip Factory Building, 59
King Yip Street, Kwun Tong Kowloon
(HK)

* cited by examiner

(**) Term: **14 Years**

Primary Examiner—Brian N. Vinson
(74) *Attorney, Agent, or Firm*—Salter & Michaelson

(21) Appl. No.: **29/158,208**

(22) Filed: **Mar. 29, 2002**

(57) **CLAIM**

The ornamental design for a paper roll stand, as shown.

(51) **LOC (7) Cl.** **20-02**

(52) **U.S. Cl.** **D6/521**

(58) **Field of Search** D6/546-50, 518,
D6/522-24; D8/300, 307-308, 315-21;
108/28-29; 211/13.1, 16, 60.1, 86.01, 87.01,
88.04, 100, 105.1-105.2, 123, 181.1, 182;
242/570, 590, 595, 597-98; 248/175, 176.1,
251, 302; 16/110.1, 412, 415

DESCRIPTION

FIG. 1 is a perspective view of a paper roll stand showing my new design;
FIG. 2 is a left side elevational view thereof;
FIG. 3 is a right side elevational view thereof;
FIG. 4 is a top plan view thereof;
FIG. 5 is a bottom plan view thereof;
FIG. 6 is a front elevational view thereof;
FIG. 7 is a rear elevational view thereof; and,
FIG. 8 is an exploded view thereof.

(56) **References Cited**

U.S. PATENT DOCUMENTS

D286,720 S * 11/1986 Minuti D6/521

1 Claim, 4 Drawing Sheets

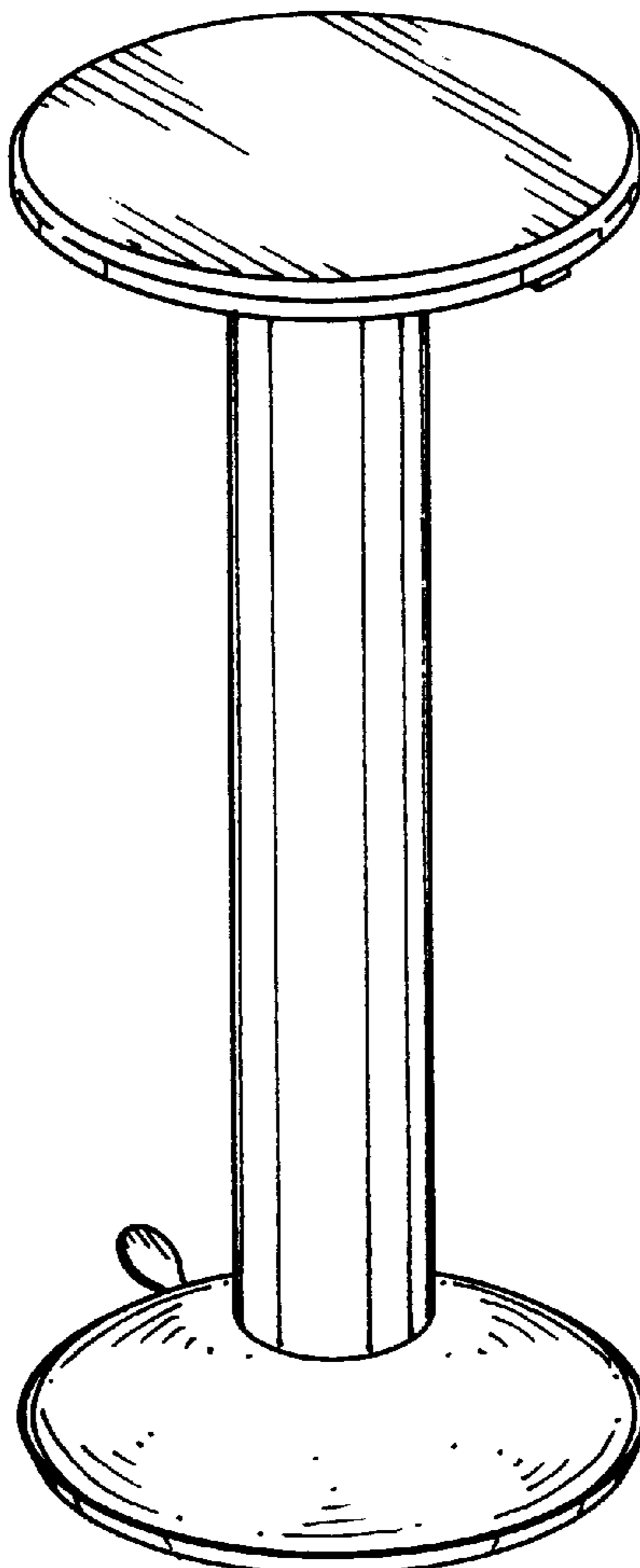

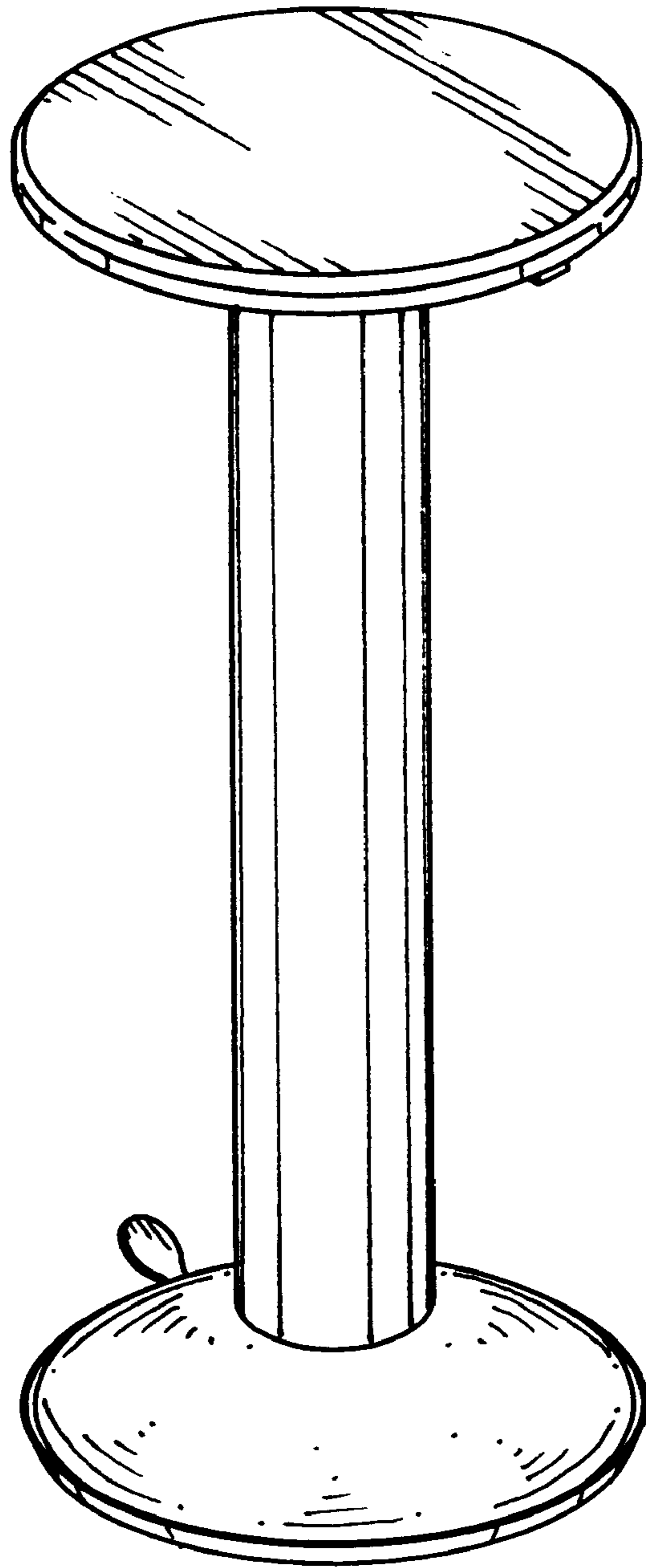

FIG. 1

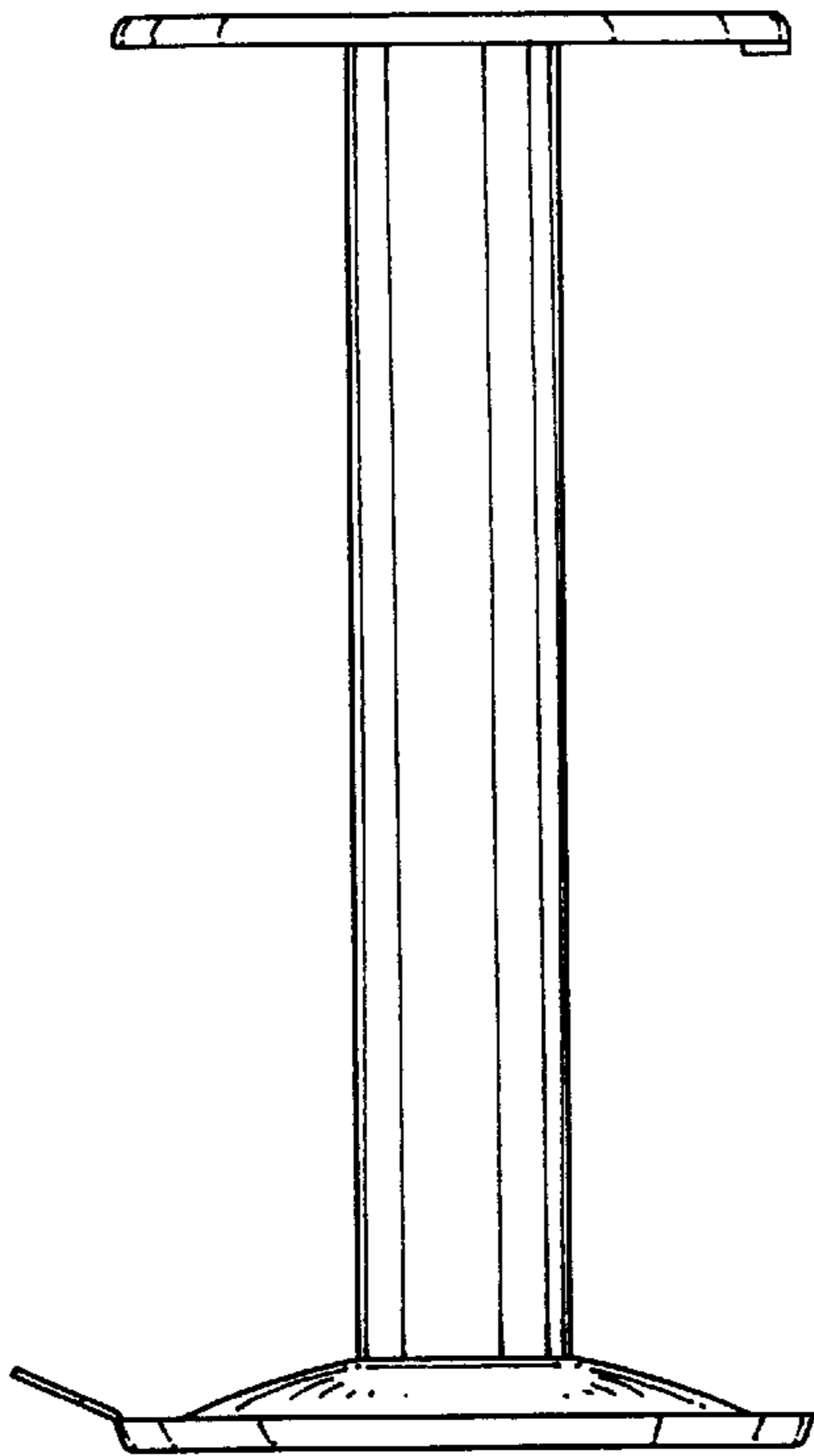

FIG. 2

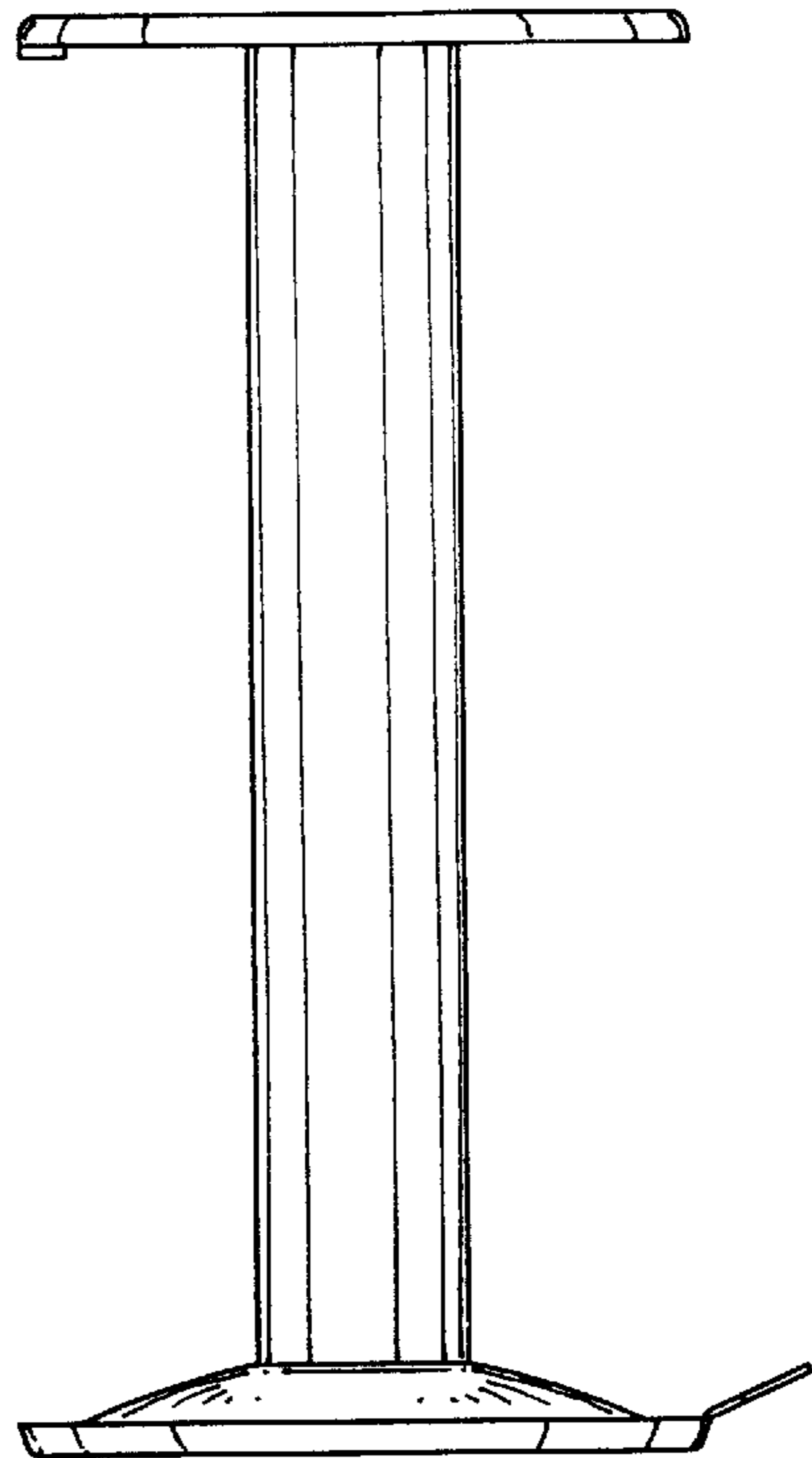

FIG. 3

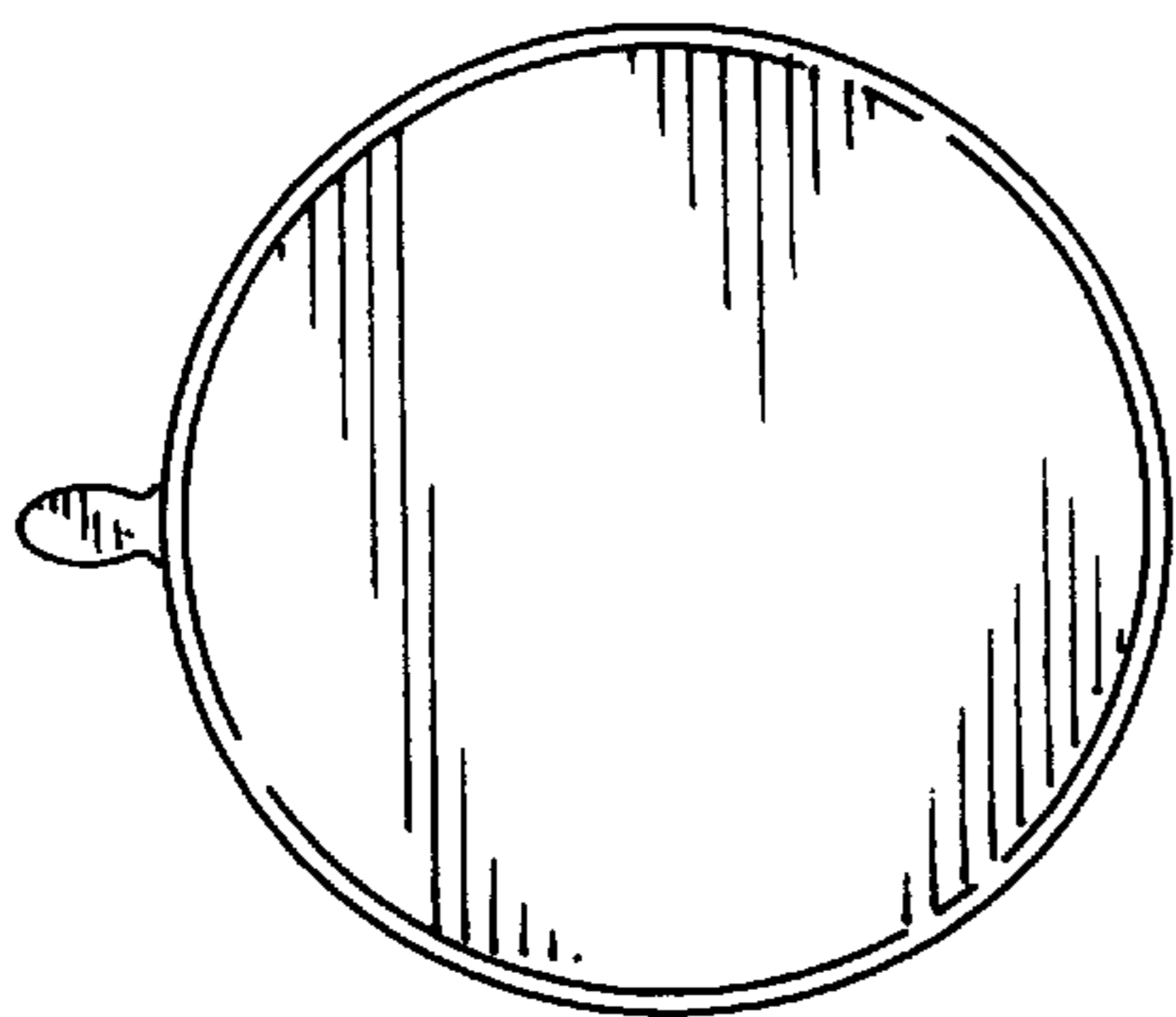

FIG. 4

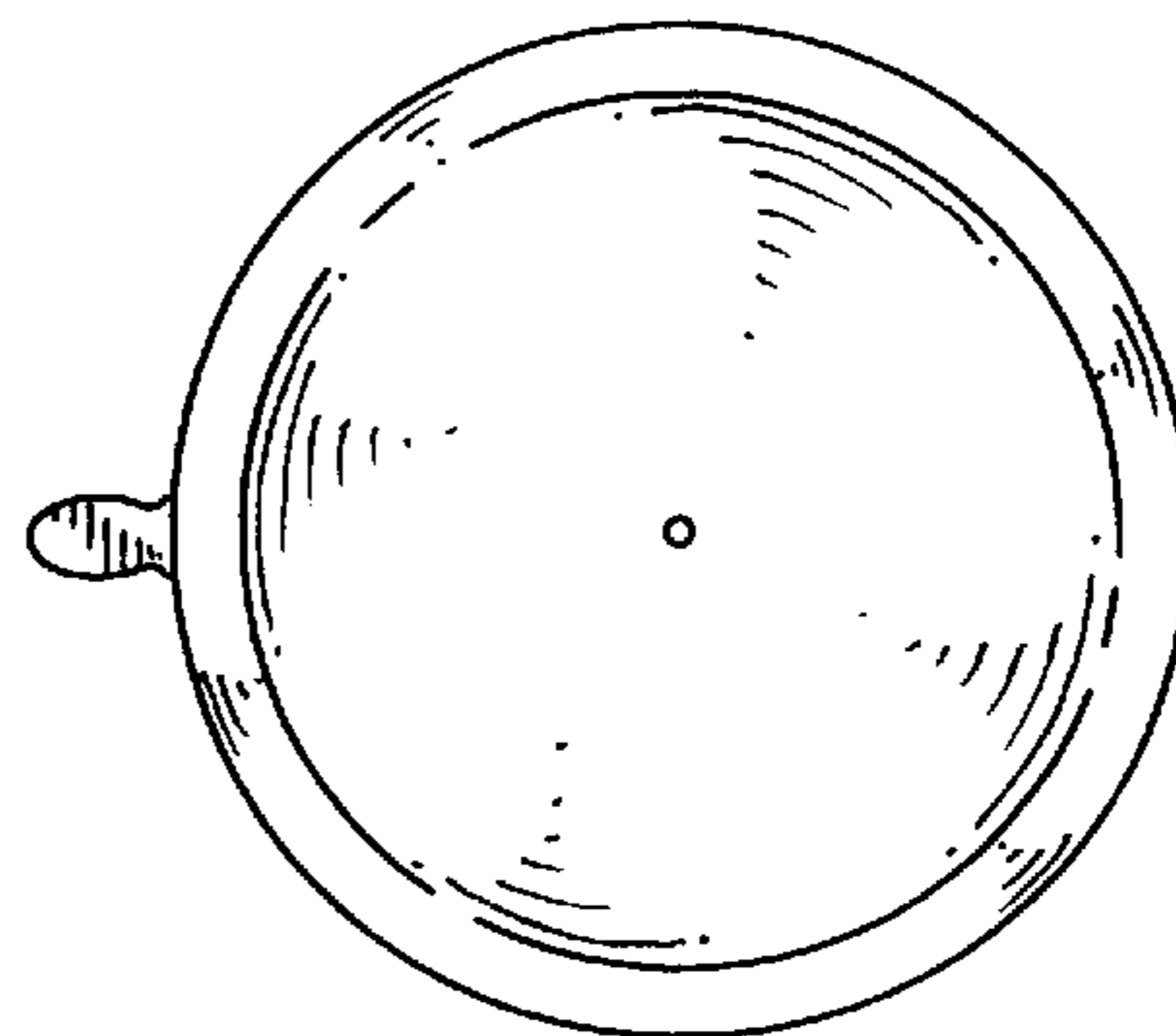

FIG. 5

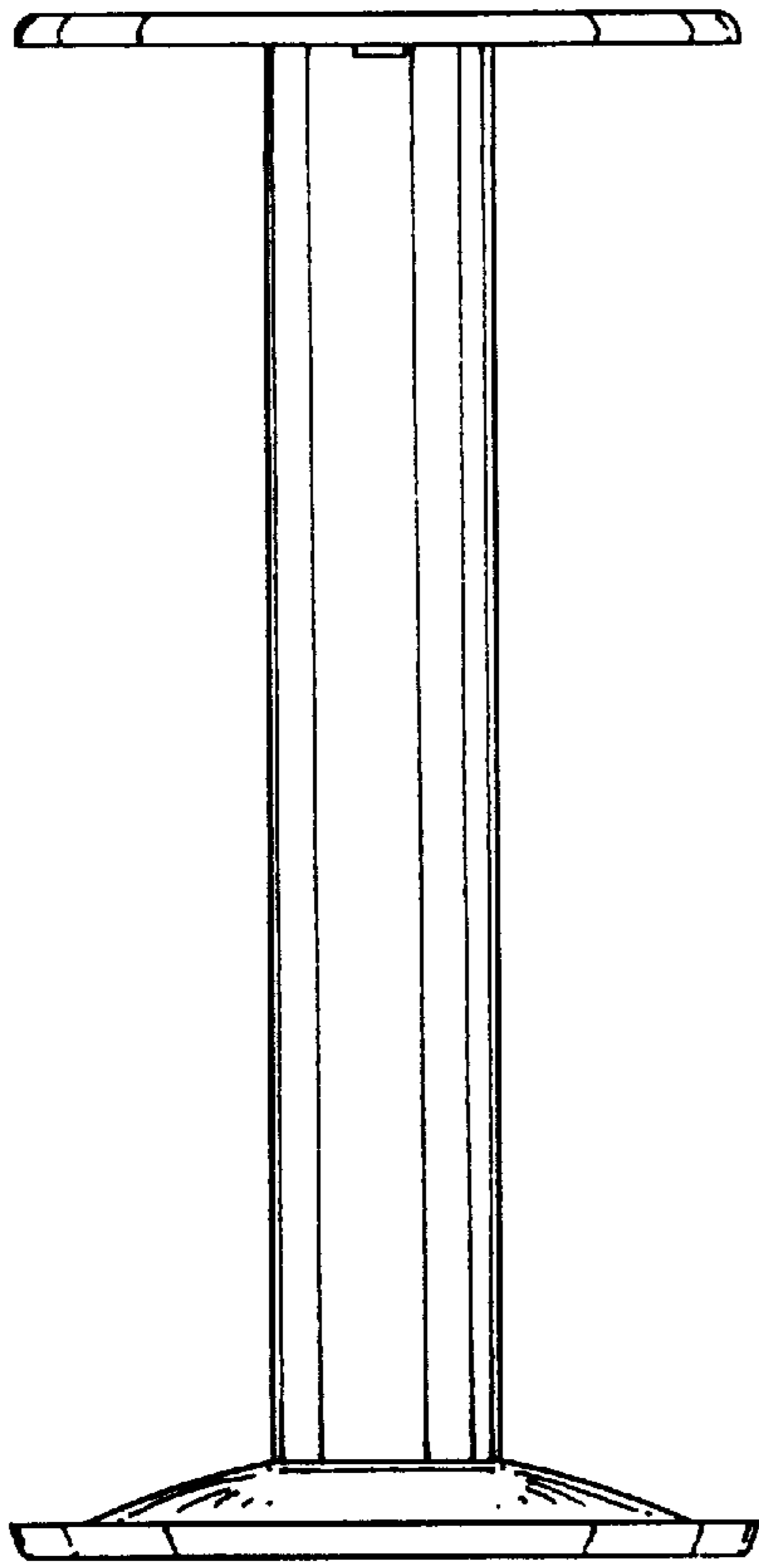

FIG. 6

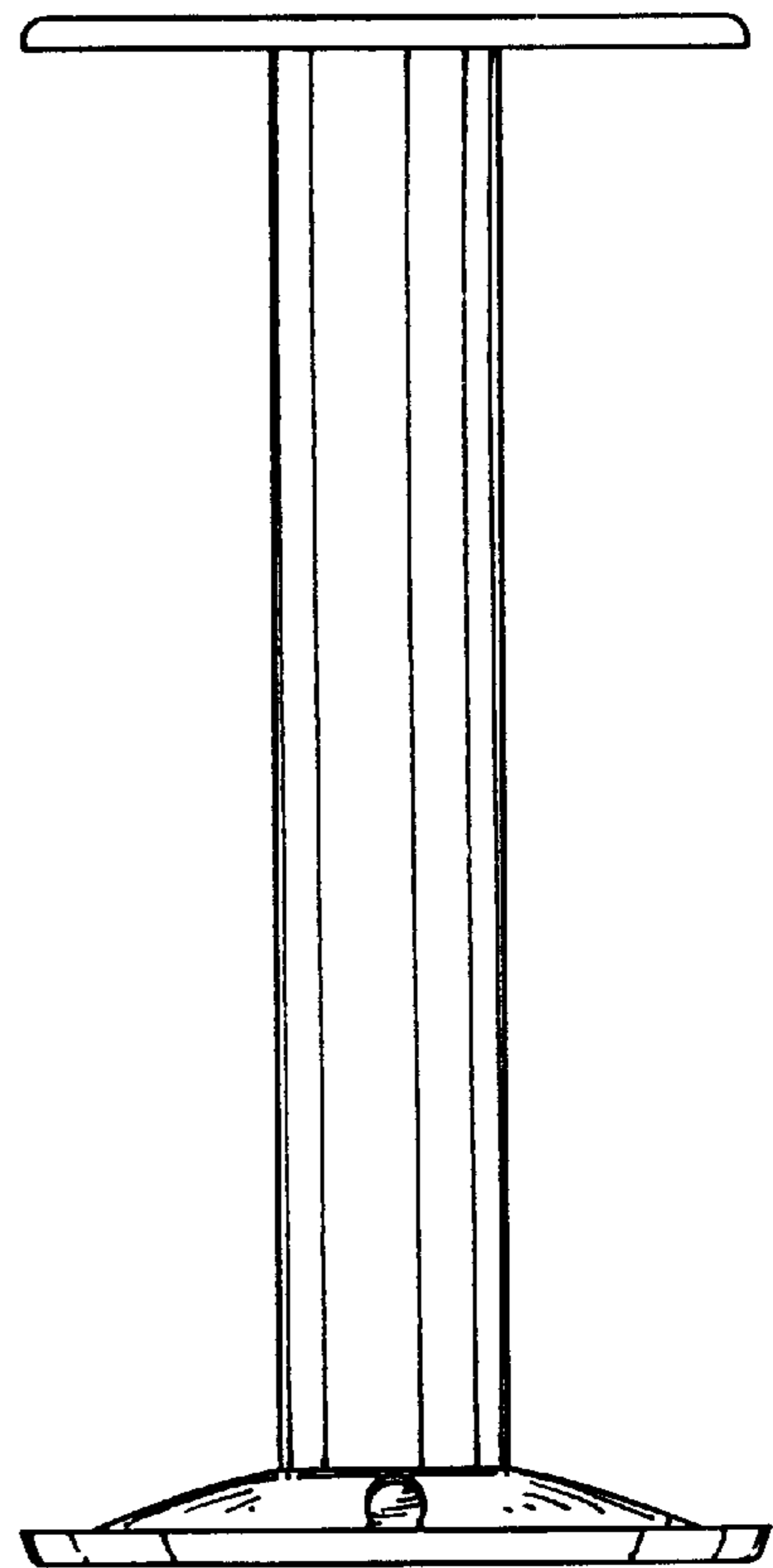

FIG. 7

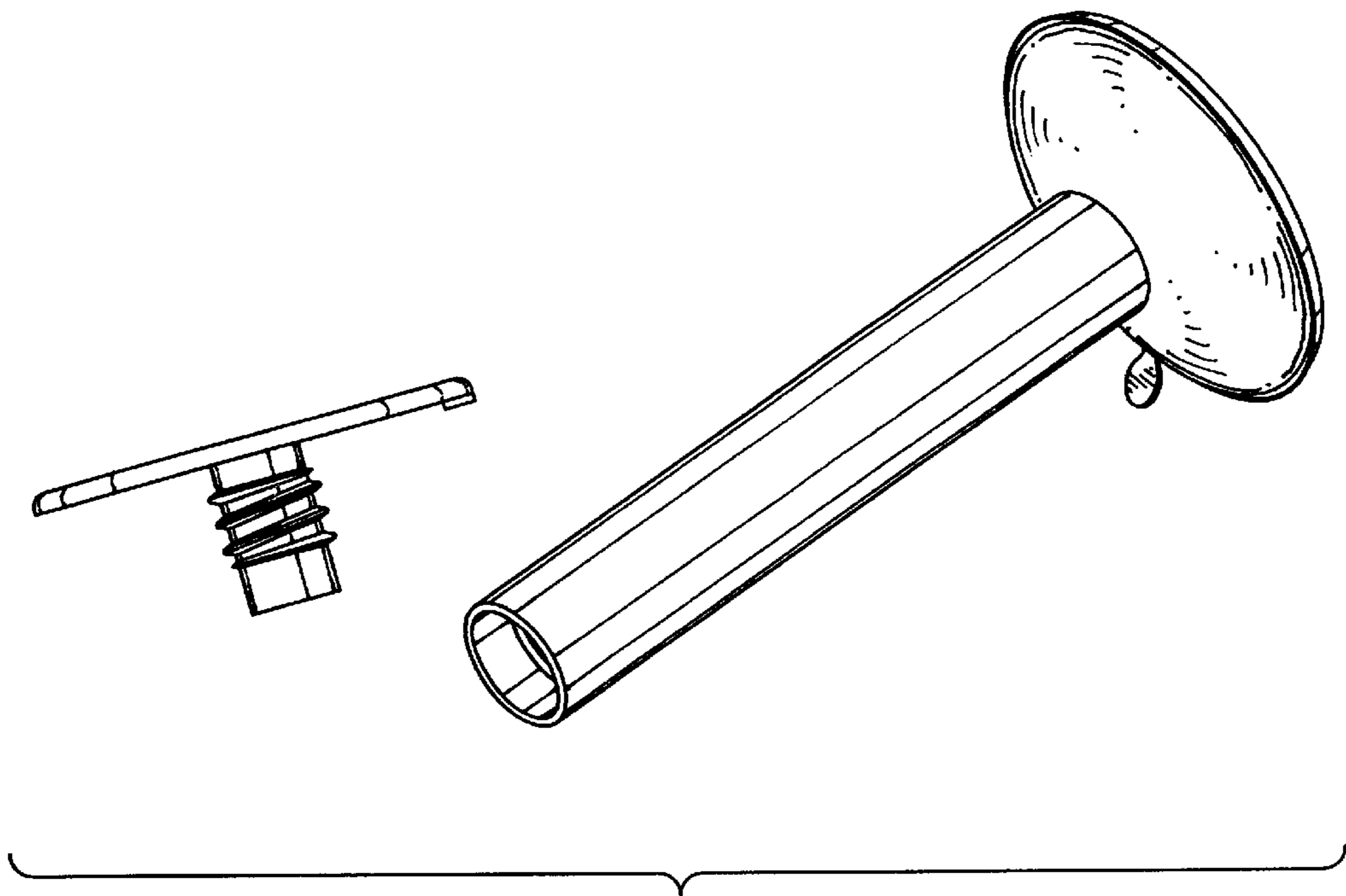

FIG. 8