



US00D474328S

(12) **United States Design Patent**
Park

(10) **Patent No.:** **US D474,328 S**

(45) **Date of Patent:** **** May 13, 2003**

(54) **SNAKE VISOR**

(75) **Inventor:** **Boo Yi Park, Seoul (KR)**

(73) **Assignee:** **Dada Corp., Seoul (KR)**

(**) **Term:** **14 Years**

(21) **Appl. No.:** **29/158,464**

(22) **Filed:** **Apr. 5, 2002**

(51) **LOC (7) Cl.** **02-03**

(52) **U.S. Cl.** **D2/893**

(58) **Field of Search** D2/865, 866, 868,
D2/869, 872, 873, 876, 879, 882, 893;
2/10, 171, 171.1, 195.1, 195.2, 209.12,
209.13

(56) **References Cited**

U.S. PATENT DOCUMENTS

222,448	A	*	12/1879	Brady	2/10
901,320	A	*	10/1908	Bruzaud	2/10
1,202,307	A	*	10/1916	Pachner	2/10
1,228,341	A		5/1917	Alphonse		
1,569,658	A	*	1/1926	Levinson	2/10
4,247,958	A	*	2/1981	Gallin	2/171.1
5,692,234	A		12/1997	Yuen		
5,704,062	A		1/1998	Caroleo		

5,929,965	A		7/1999	Berke		
6,138,279	A	*	10/2000	Gore	2/175.1
6,237,147	B1		5/2001	Brockman		
6,314,583	B1	*	11/2001	Cho	2/195.1

* cited by examiner

Primary Examiner—Doris V. Coles

Assistant Examiner—Mimosa De

(57) **CLAIM**

The ornamental design for “snake visor”, as shown and described.

DESCRIPTION

FIG. 1 is a perspective view of “snake visor” showing my new design

FIG. 2 is a front elevational view of FIG. 1

FIG. 3 is a right elevational view of FIG. 1; a left elevational view is same image as FIG. 3

FIG. 4 is a top plan view of FIG. 1

FIG. 5 is a bottom plan view of FIG. 1; and,

FIG. 6 is a rear elevational view of FIG. 1.

The broken lines showing of a cap in the drawing are for illustrative purposes only and form no part of the claimed design and the broken line shown on the visor is intended to represent stitching.

1 Claim, 3 Drawing Sheets

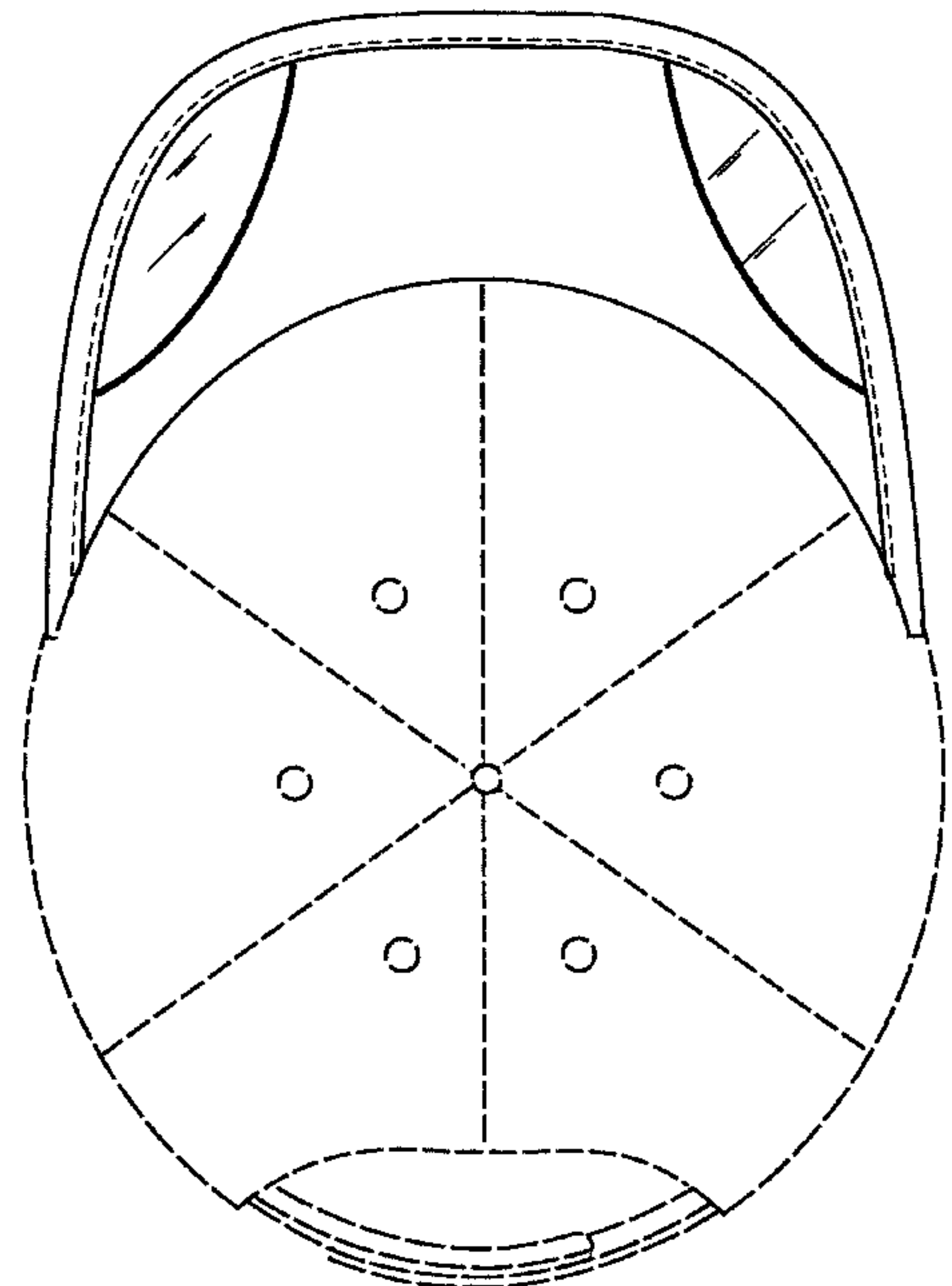
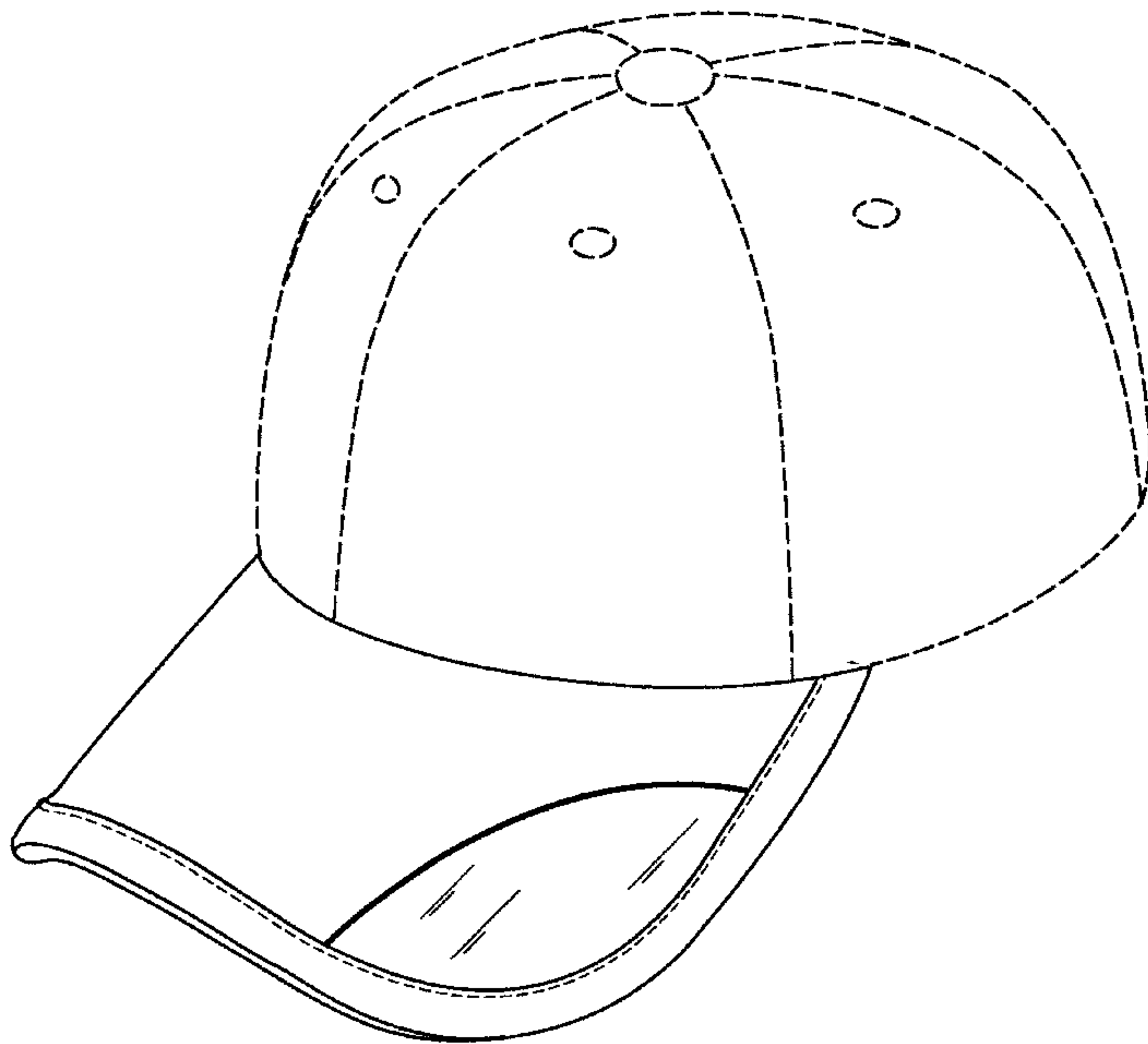

FIG. 1

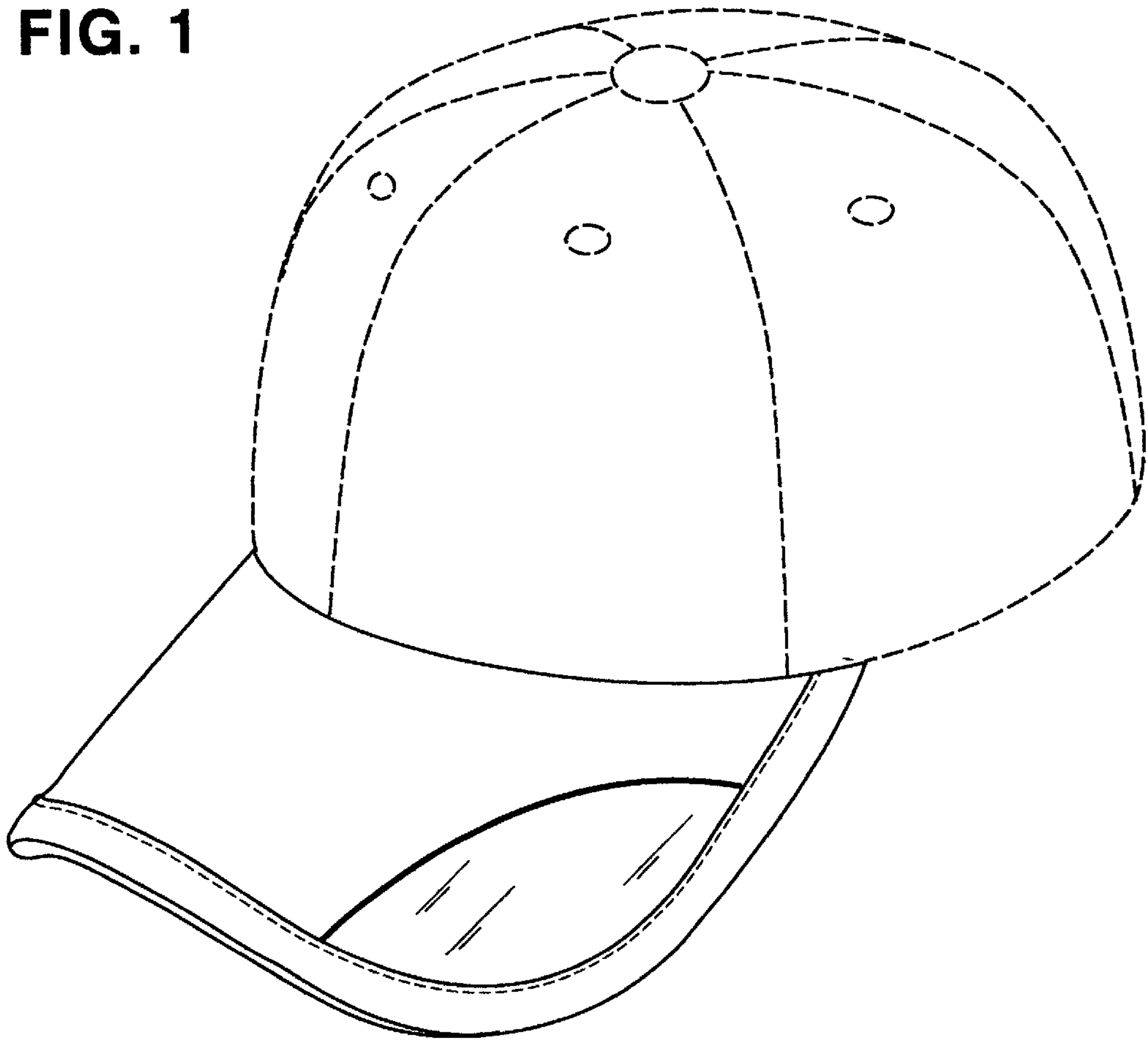

FIG. 2

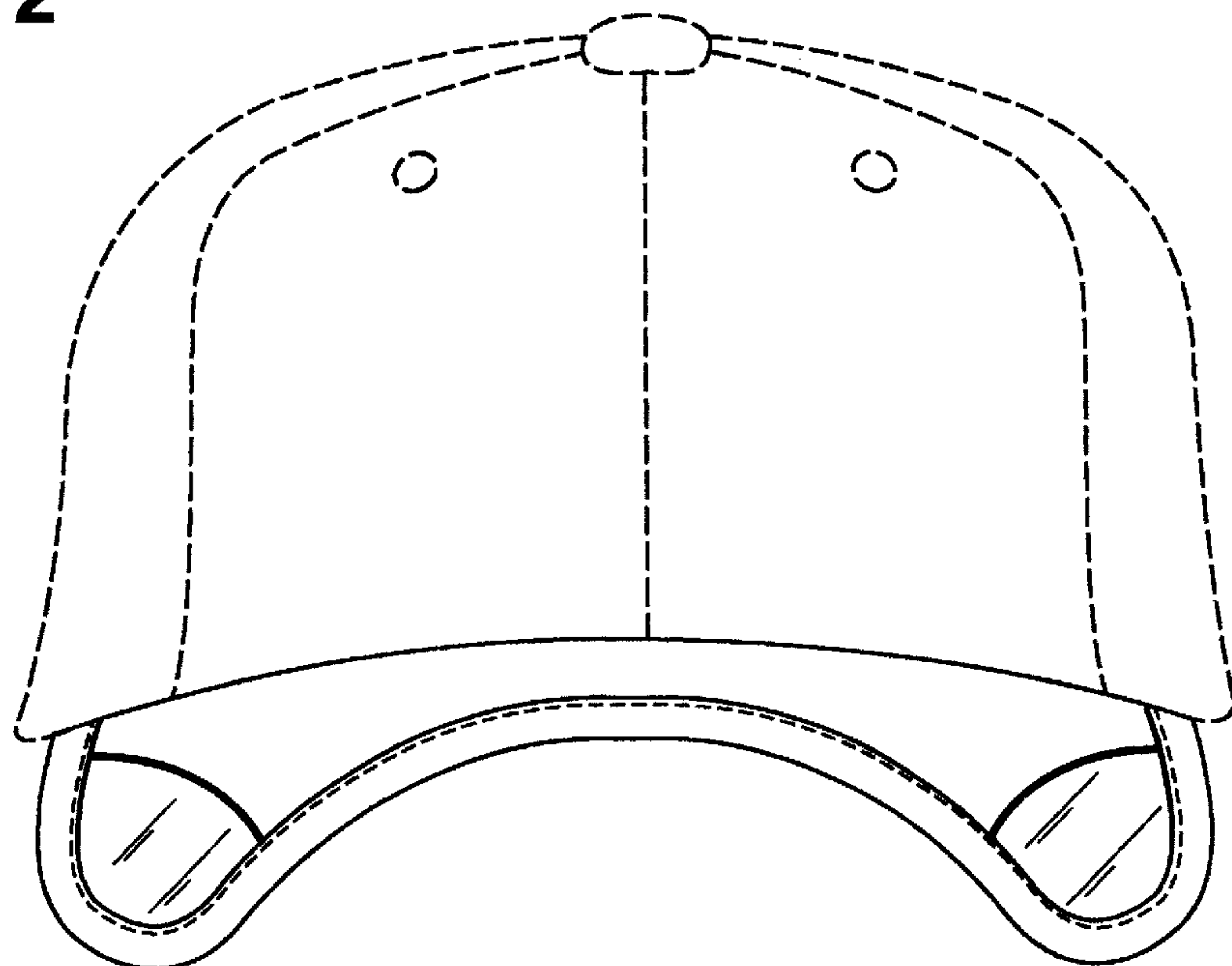

FIG. 3

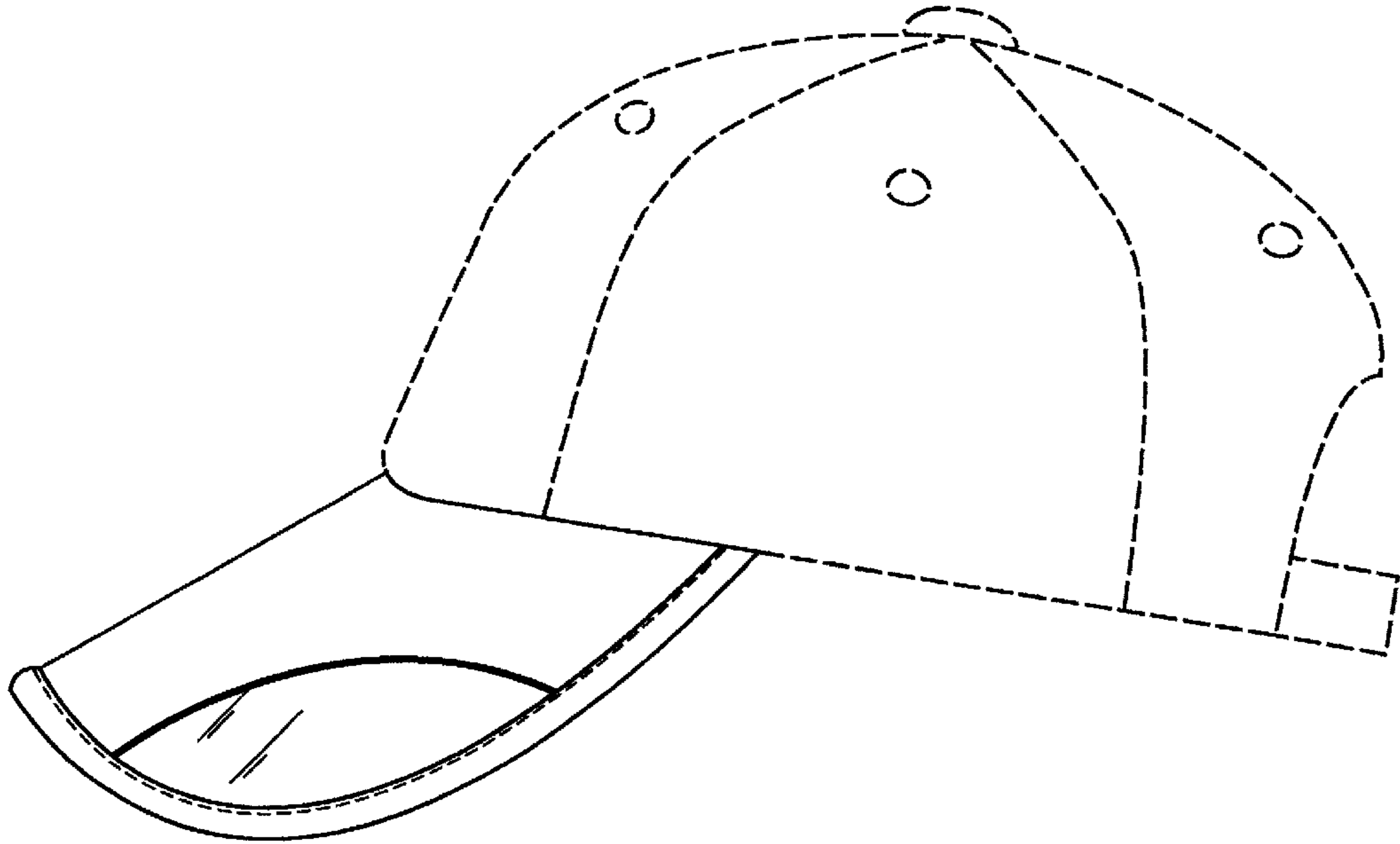

FIG. 4

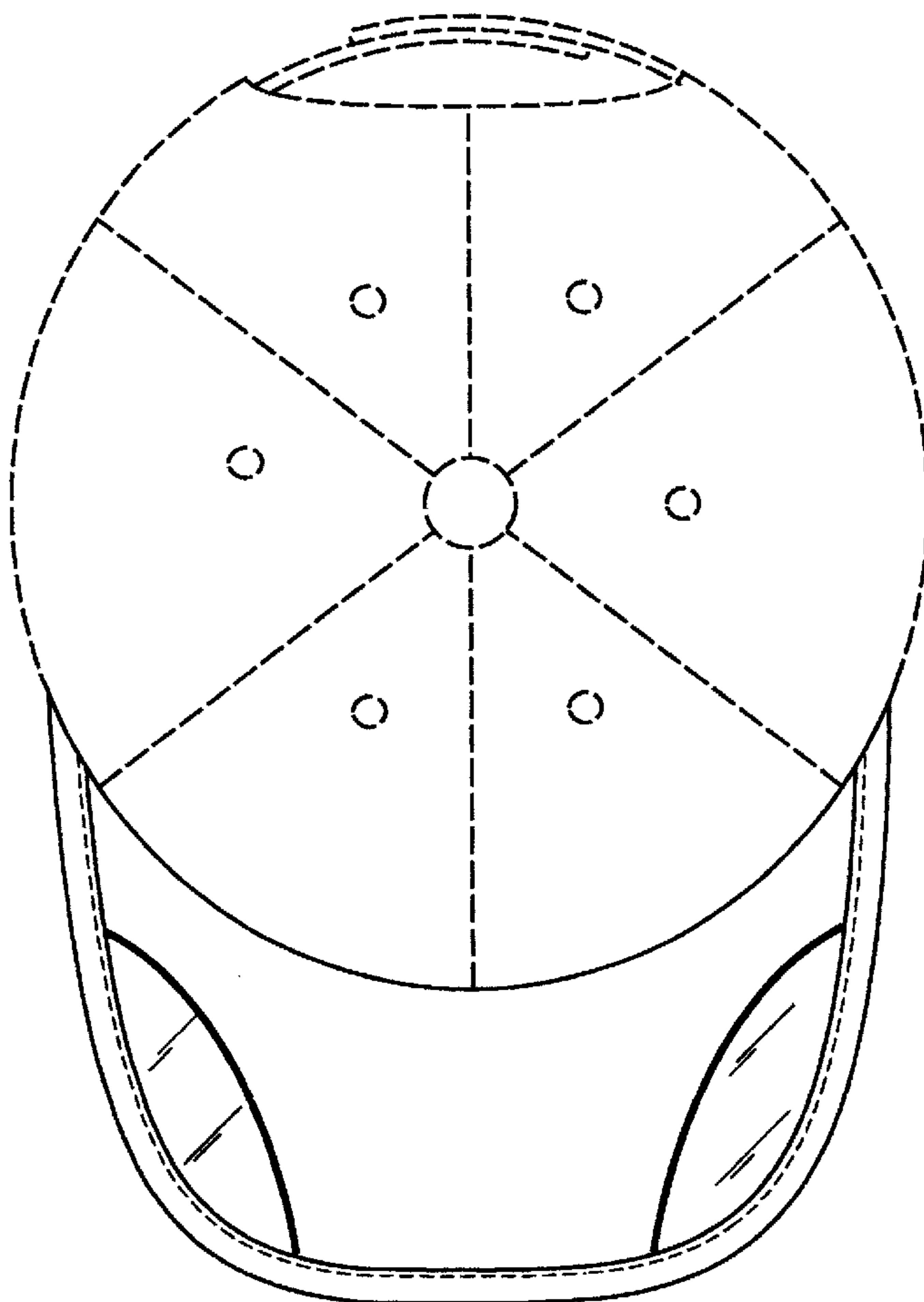

FIG. 5

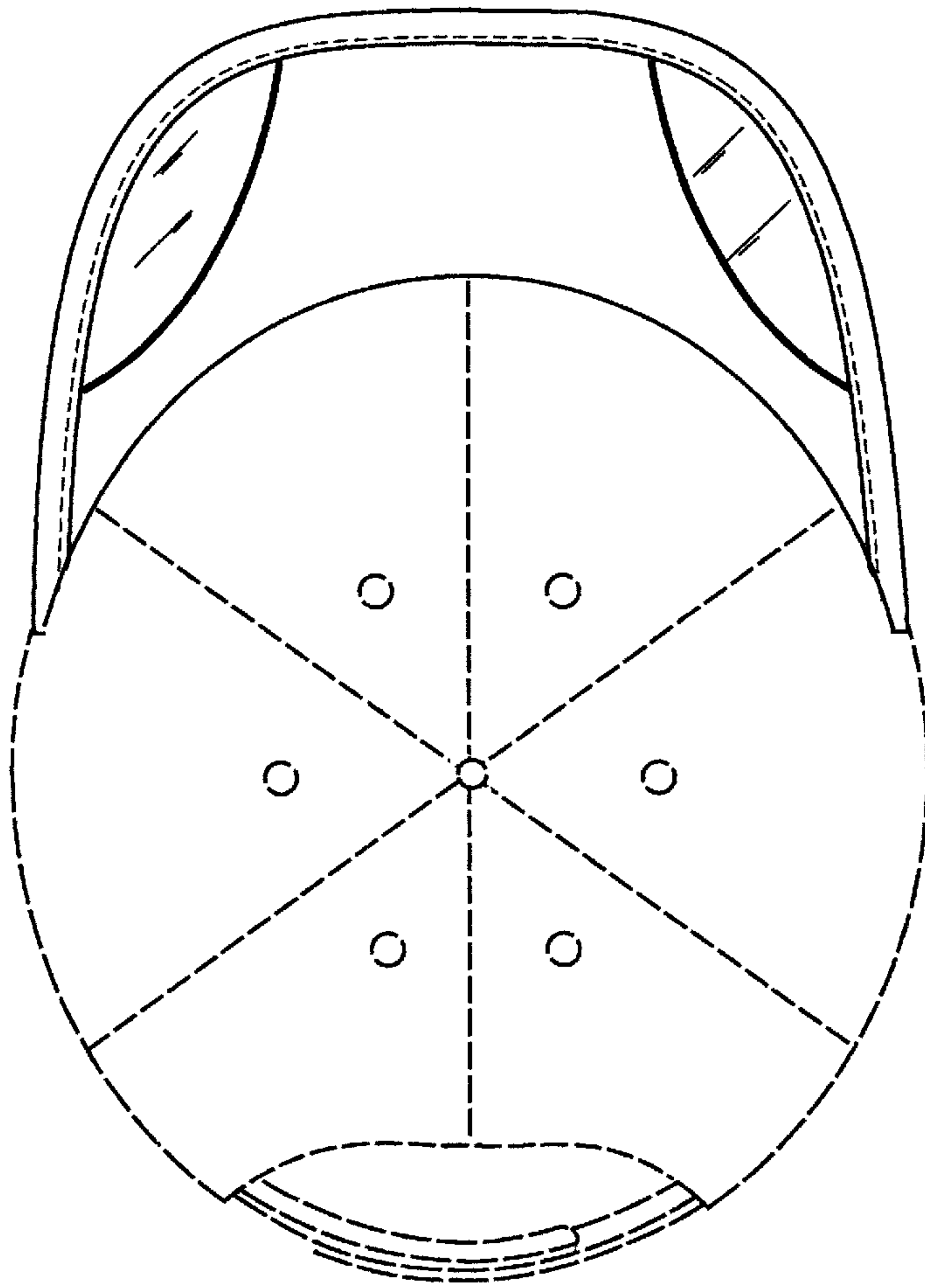

FIG. 6

