



US00D474232S

(12) **United States Design Patent**  
**Kawai et al.**

(10) **Patent No.: US D474,232 S**

(45) **Date of Patent: \*\* May 6, 2003**

(54) **IMAGE FORMING APPARATUS**

D464,370 S \* 10/2002 Kunihiro et al. .... D18/43

(75) Inventors: **Tachio Kawai**, Odawara (JP); **Kanji Yokomori**, Odawara (JP); **Jun Miyamoto**, Mishima (JP); **Tadashi Horikawa**, Susono (JP); **Takeshi Arimitsu**, Odawara (JP); **Koji Hashimoto**, Shizuoka-ken (JP); **Susumu Nittani**, Shizuoka-ken (JP)

**OTHER PUBLICATIONS**

Canon Catalogue "Laser Shot", Jan. 17, 2002.

\* cited by examiner

*Primary Examiner*—Caron D. Veynar  
(74) *Attorney, Agent, or Firm*—Fitzpatrick, Cella, Harper & Scinto

(73) Assignee: **Canon Kabushiki Kaisha**, Tokyo (JP)

(\*\*) Term: **14 Years**

(21) Appl. No.: **29/163,919**

(22) Filed: **Jul. 16, 2002**

(30) **Foreign Application Priority Data**

Mar. 15, 2002 (JP) ..... 2002-006830

(51) **LOC (7) Cl.** ..... **16-03**

(52) **U.S. Cl.** ..... **D18/40**

(58) **Field of Search** ..... D18/36, 40, 43,  
D18/56; 399/24-27, 31, 110, 130, 252,  
262; 222/DIG. 1

(56) **References Cited**

**U.S. PATENT DOCUMENTS**

D418,862 S \* 1/2000 Ogawa et al. .... D18/43

(57) **CLAIM**

The ornamental design for an image forming apparatus, as shown and described.

**DESCRIPTION**

FIG. 1 is a front view of an image forming apparatus showing our new design;

FIG. 2 is a rear view thereof;

FIG. 3 is a top plan view thereof;

FIG. 4 is a bottom plan view thereof;

FIG. 5 is a left side view thereof;

FIG. 6 is a right side view thereof;

FIG. 7 is a perspective view as viewed from top thereof; and,

FIG. 8 is a perspective view as viewed from bottom thereof.

**1 Claim, 8 Drawing Sheets**

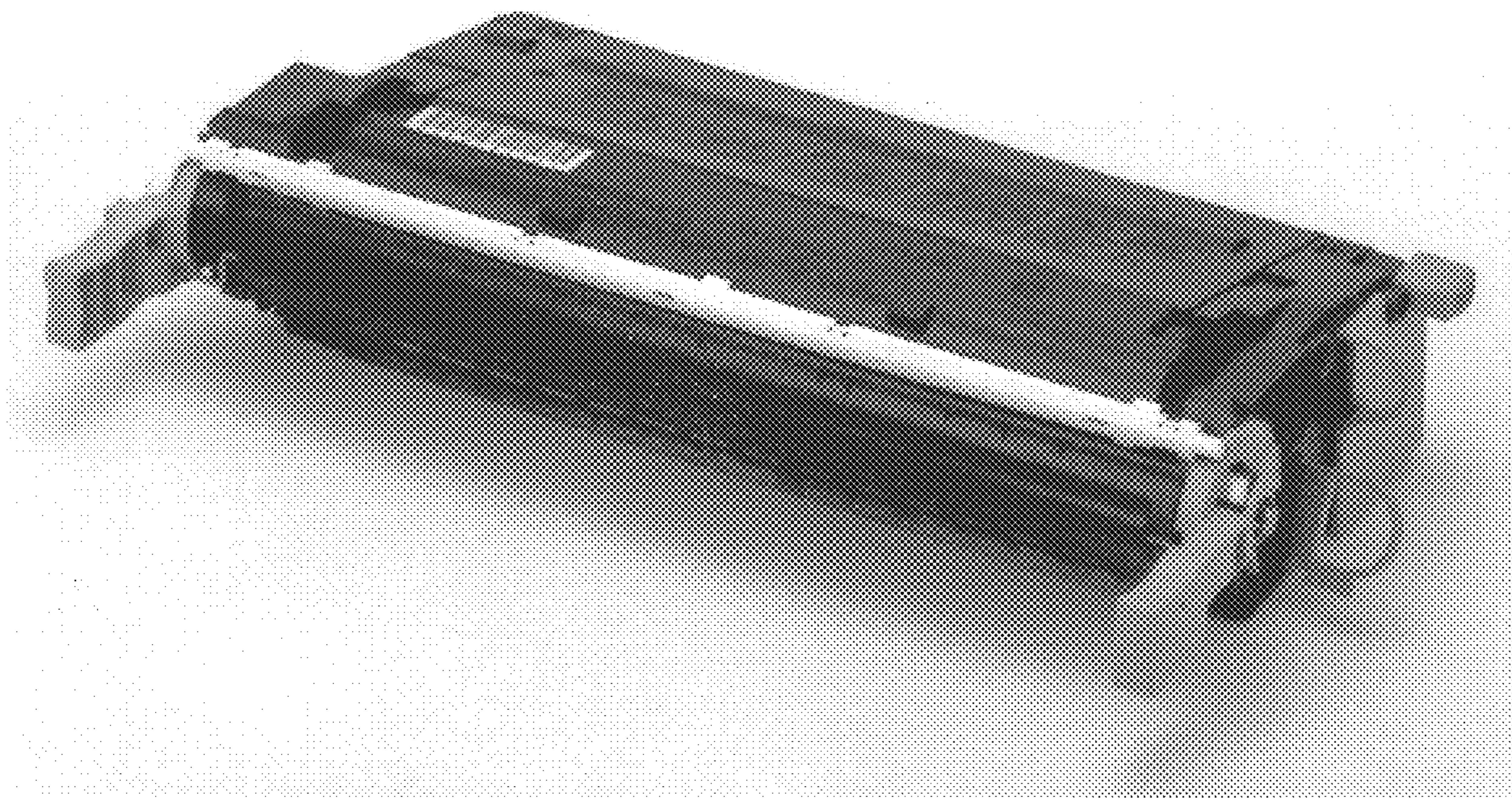

FIG. 1

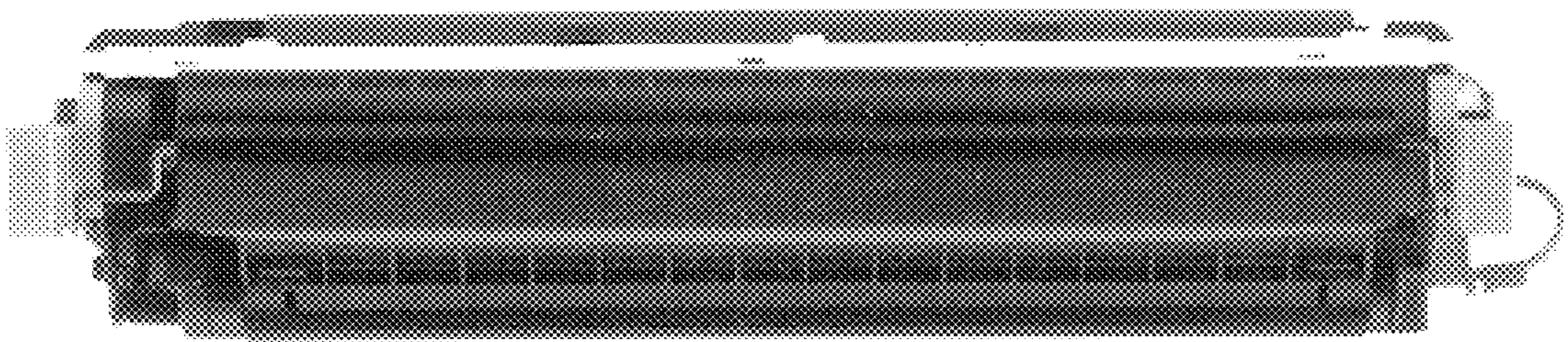
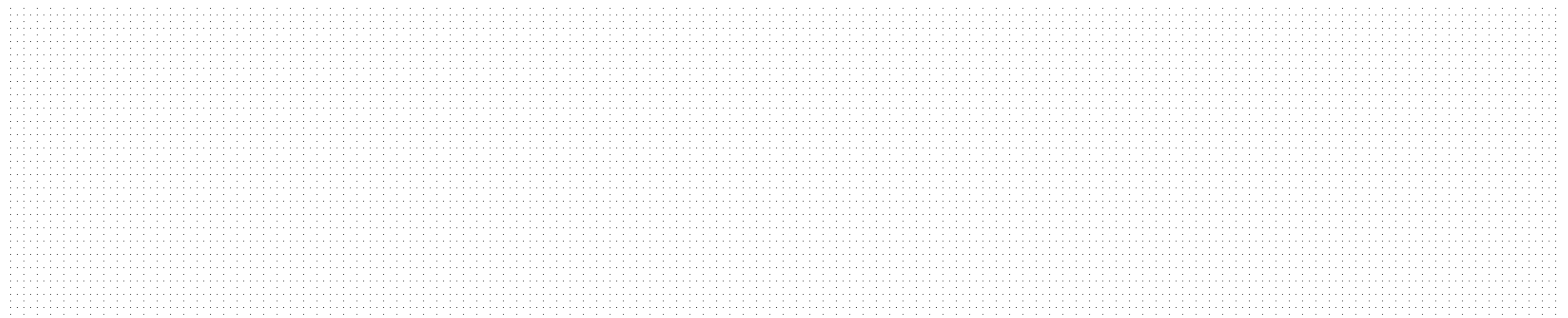

FIG. 2

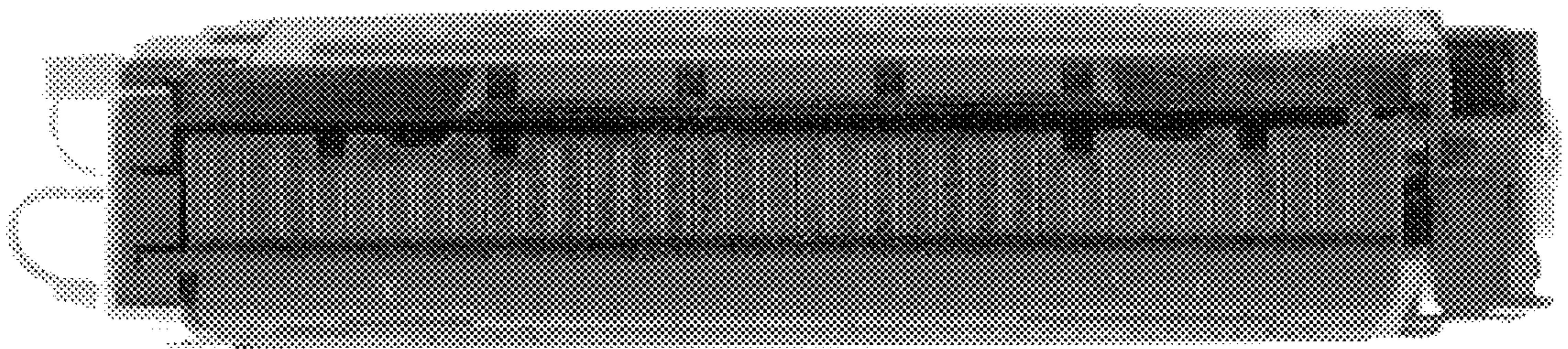

FIG. 3

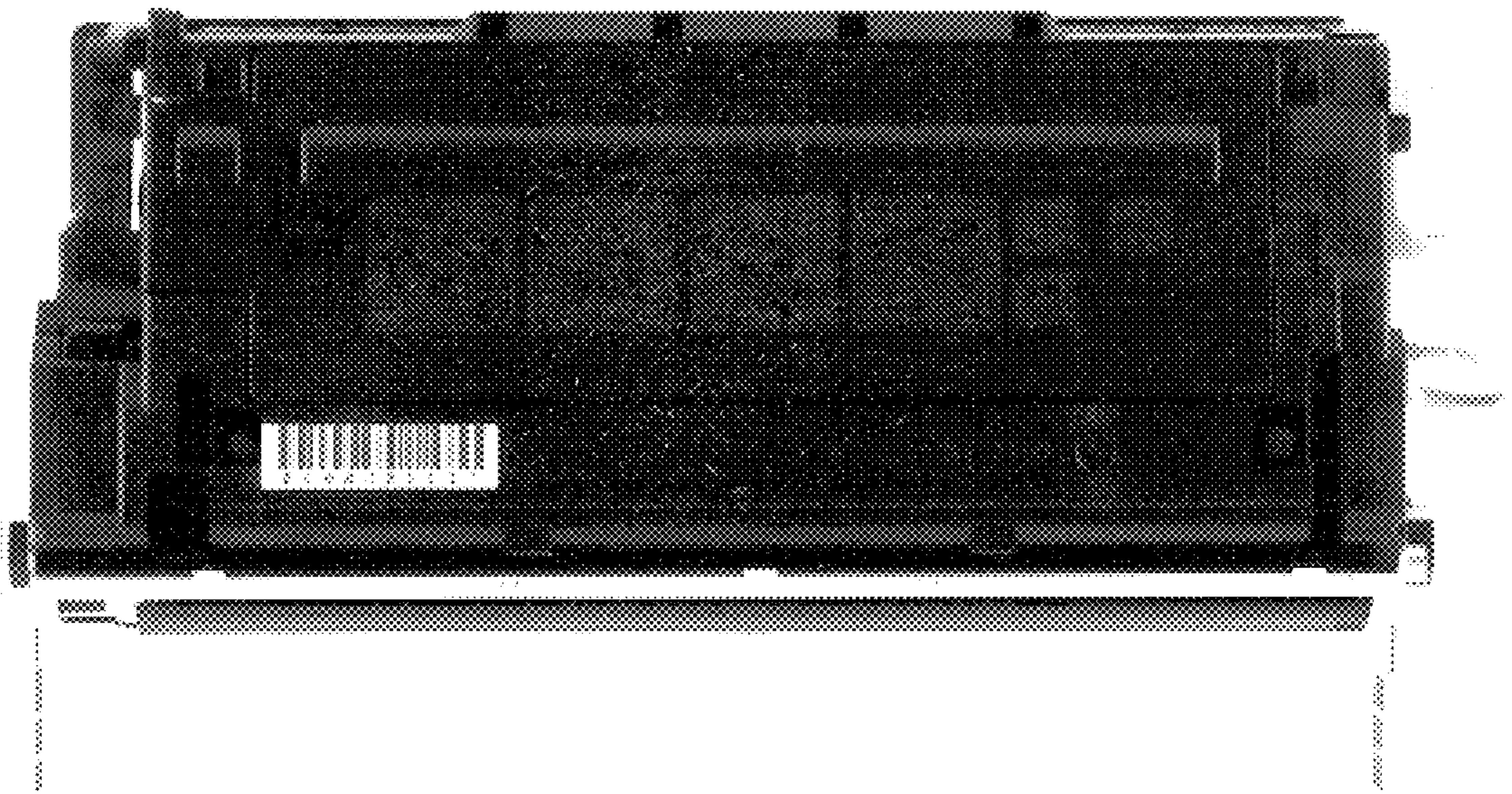

FIG. 4

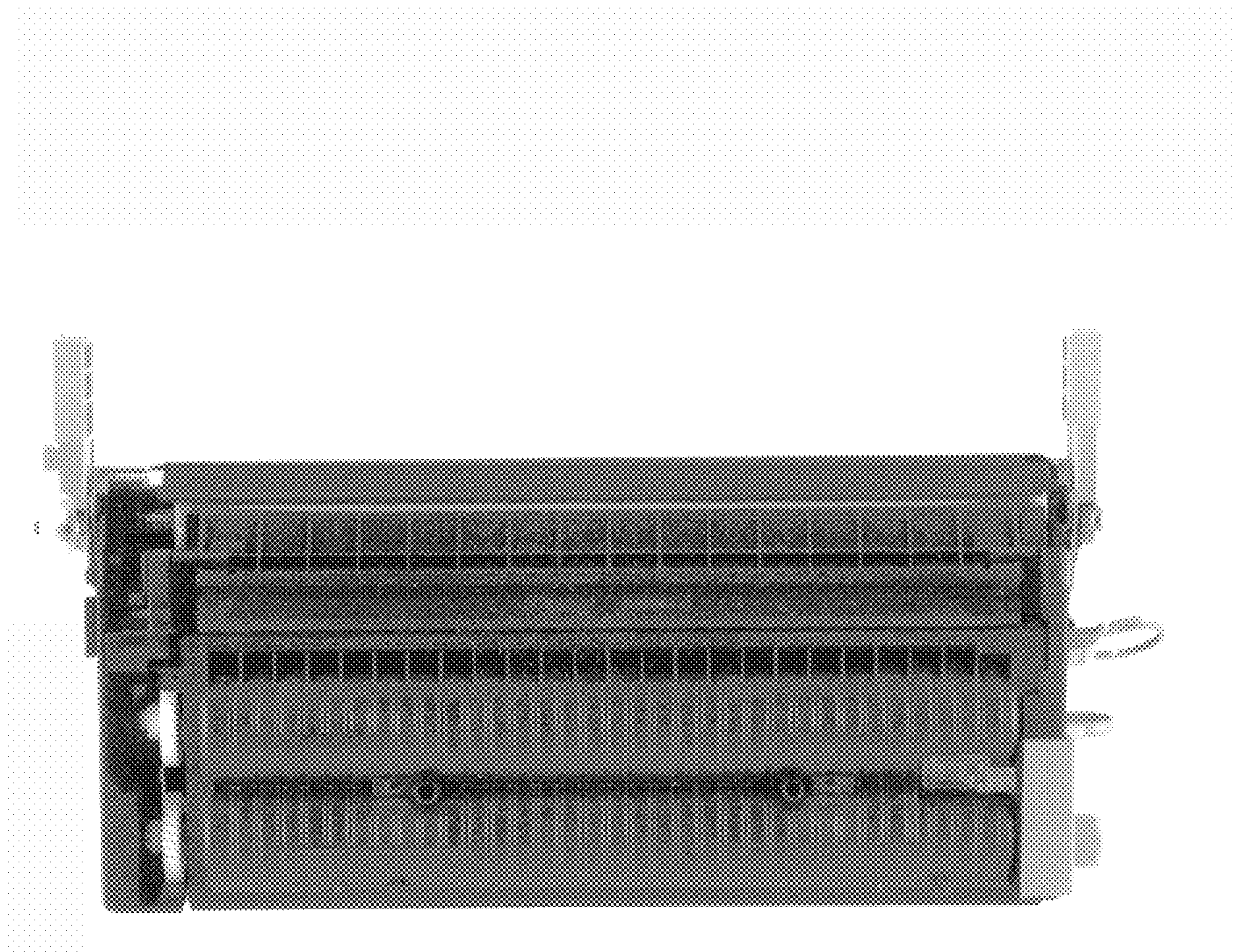
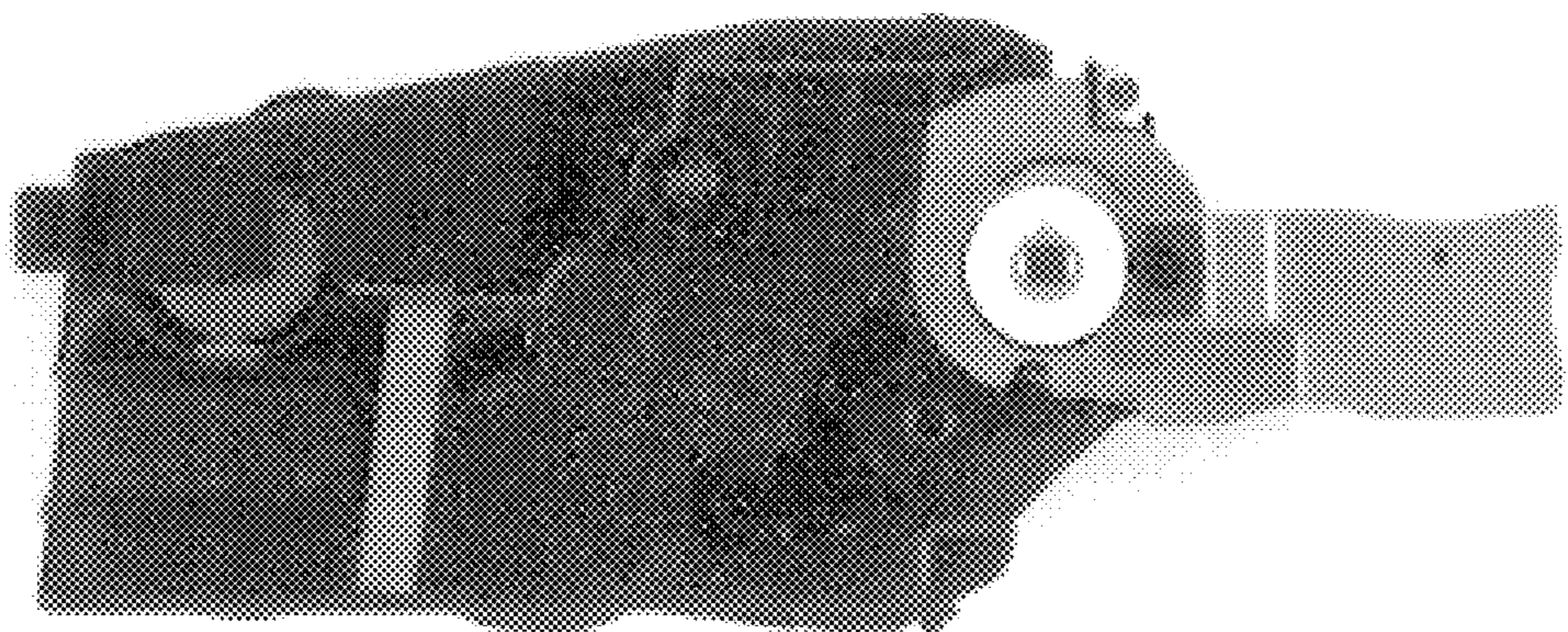
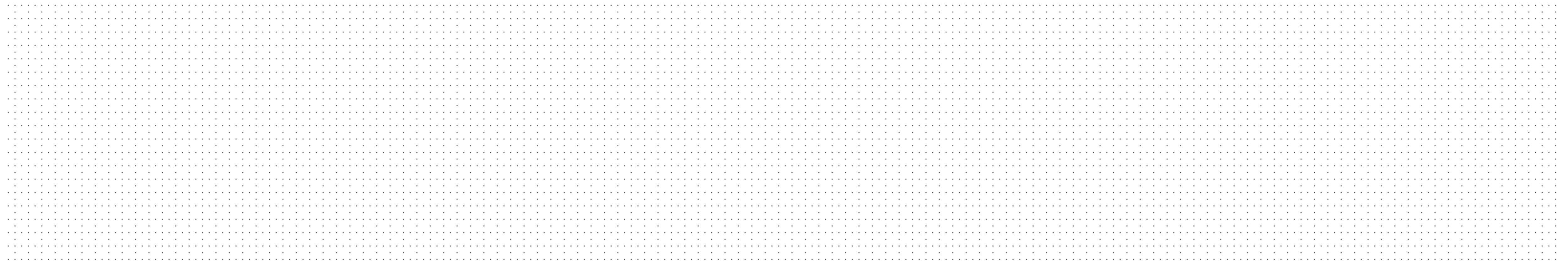

FIG. 5



# FIG. 6

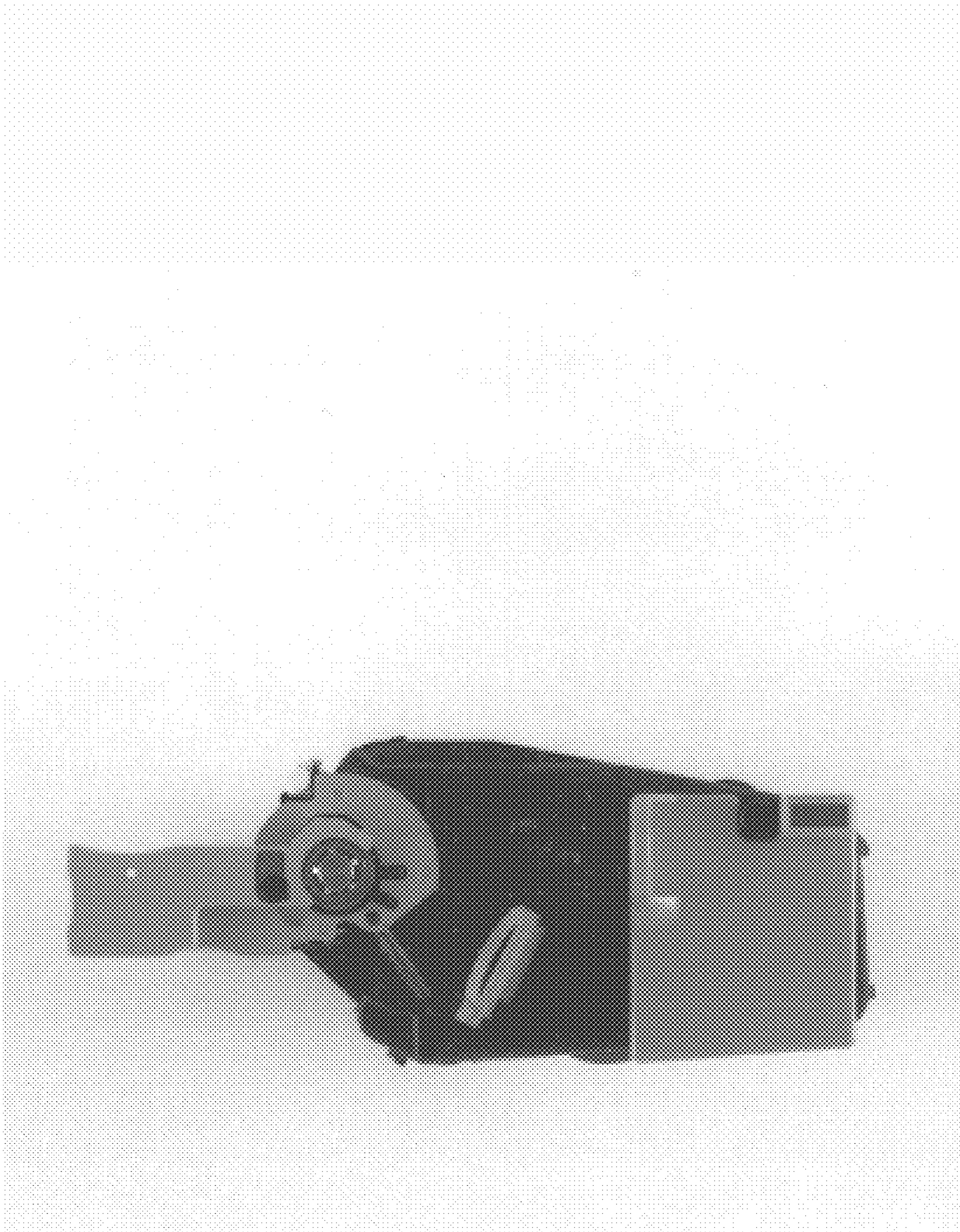

FIG. 7

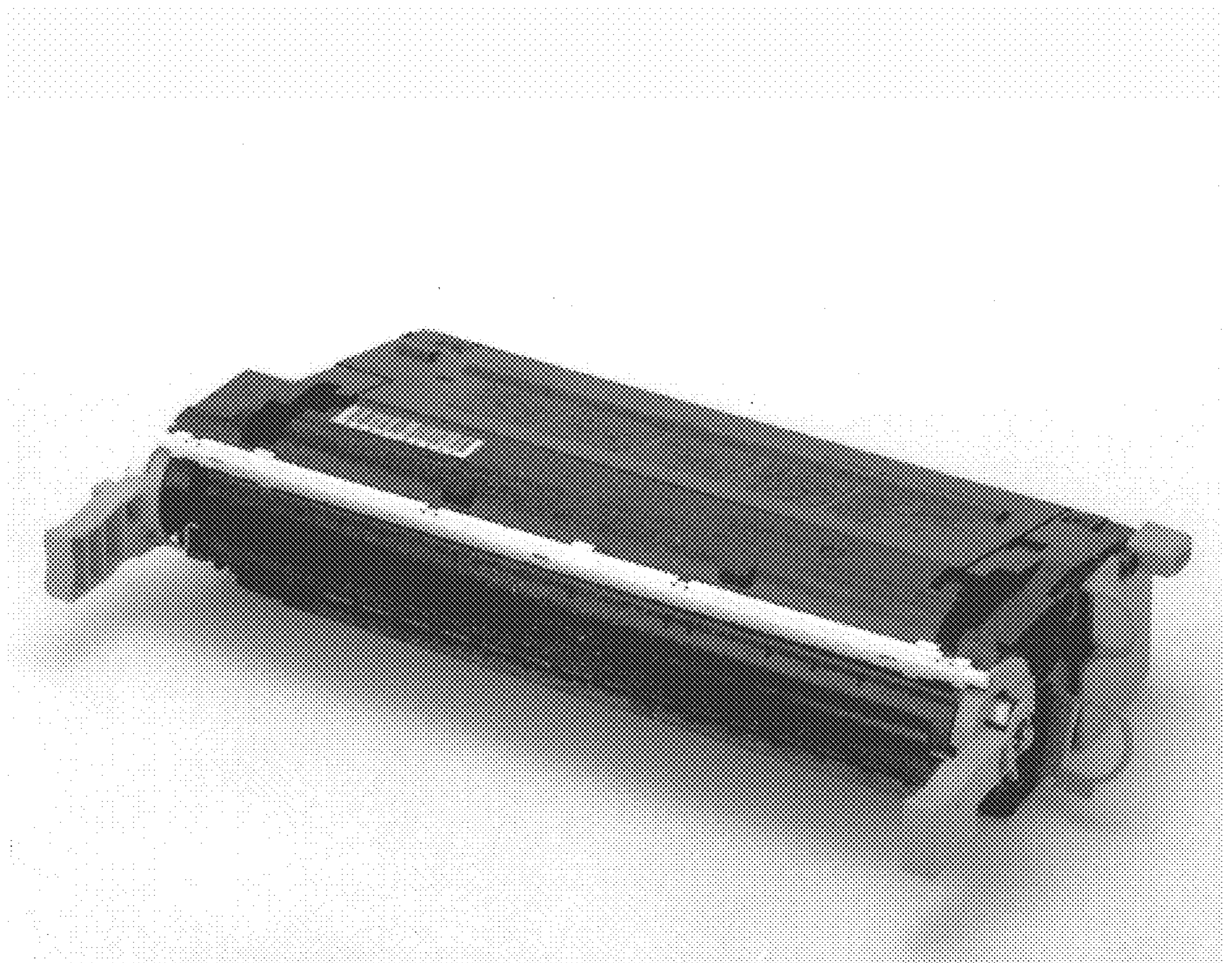



FIG. 8

