



US00D474049S

(12) **United States Design Patent**
Wakasugi et al.

(10) **Patent No.:** **US D474,049 S**

(45) **Date of Patent:** **** May 6, 2003**

(54) **DESK**

(75) Inventors: **Kouichi Wakasugi**, Tokyo-To (JP);
Yuji Inoue, Tokyo-To (JP); **Kunihide**
Oshinomi, Tokyo-To (JP); **Naoki**
Terada, Tokyo-To (JP)

(73) Assignee: **Uchida Yoko Co., Ltd.**, Tokyo (JP)

(**) Term: **14 Years**

(21) Appl. No.: **29/160,255**

(22) Filed: **May 8, 2002**

(30) **Foreign Application Priority Data**

Nov. 8, 2001 (JP) 2001-032909

(51) **LOC (7) Cl.** **06-03**

(52) **U.S. Cl.** **D6/484**

(58) **Field of Search** D6/480-489, 495-499,
D6/511, 422; 108/153.1, 155, 156, 157.1,
161; 248/188, 188.1, 188.7, 188.8

(56) **References Cited**

U.S. PATENT DOCUMENTS

D98,365 S * 1/1936 Pumphrey D6/480

D100,165 S * 6/1936 Kalpakoff D6/480
D292,856 S * 11/1987 Jasinski D6/484
D308,615 S * 6/1990 Hubert D6/429
D448,212 S * 9/2001 Petersen D6/480

* cited by examiner

Primary Examiner—Janice E. Seeger

(74) *Attorney, Agent, or Firm*—Birch, Stewart, Kolasch &
Birch, LLP

(57) **CLAIM**

The ornamental design for desk, as shown and described.

DESCRIPTION

FIG. 1 is a front elevational view of a desk showing our new design;
FIG. 2 is a rear elevational view thereof;
FIG. 3 is a top plan view thereof;
FIG. 4 is a bottom plan view thereof;
FIG. 5 is a right side elevational view thereof;
FIG. 6 is a left side elevational view thereof; and,
FIG. 7 is a perspective view, the showing of the plurality of desks adjacent to each other is for environmental purposes only and forms no part of the claimed design.

1 Claim, 3 Drawing Sheets

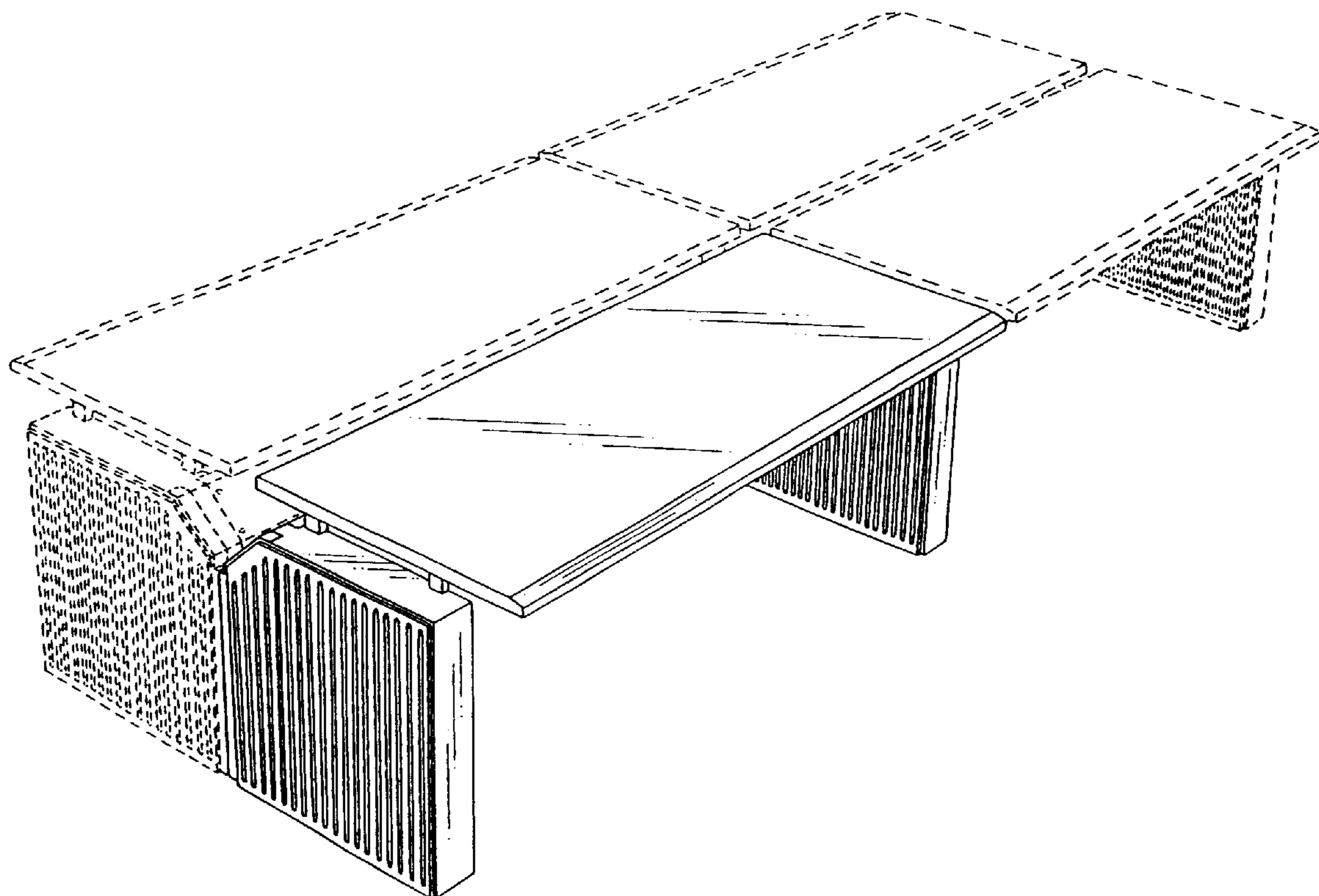

FIG. 1

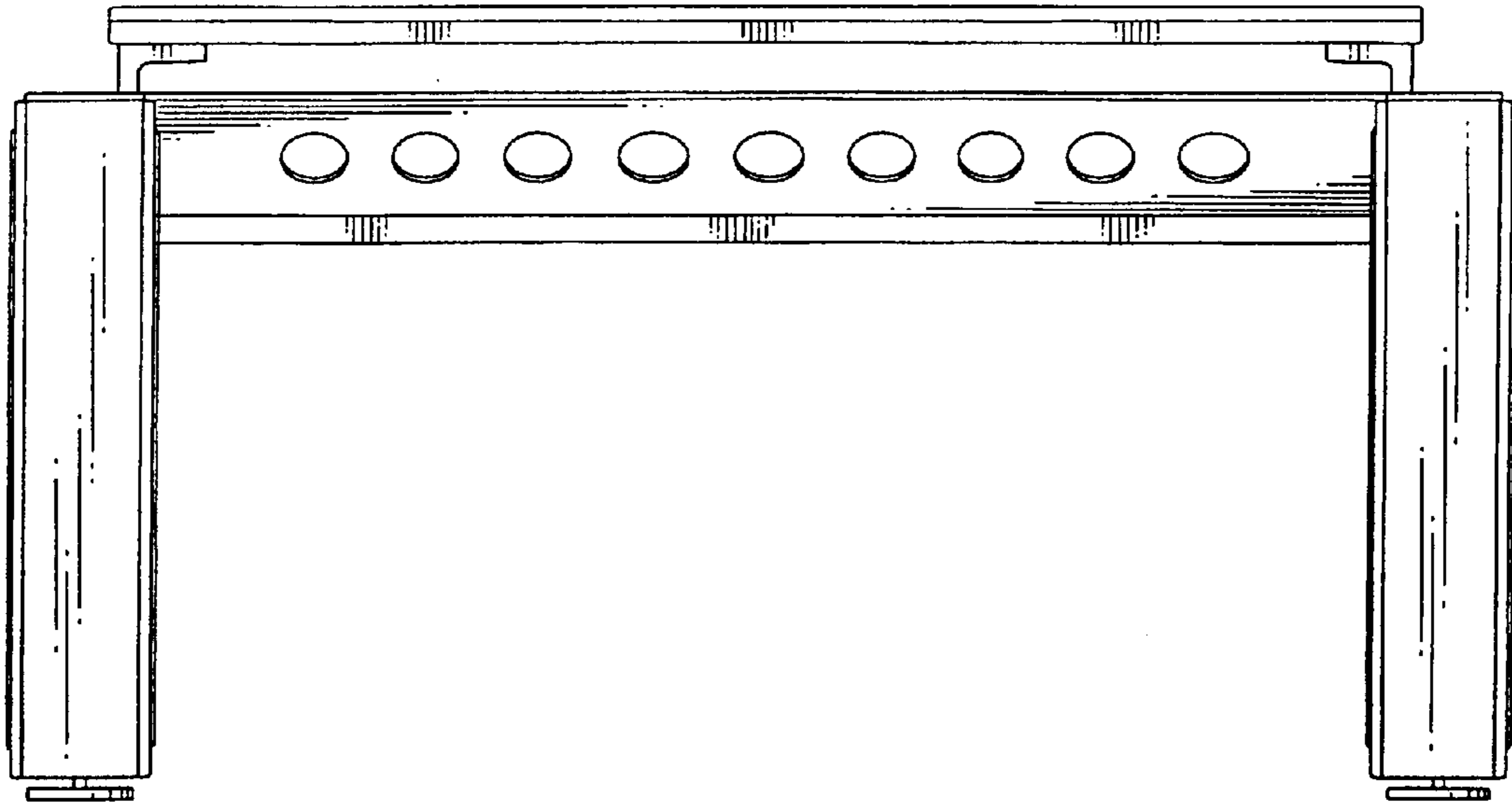

FIG. 2

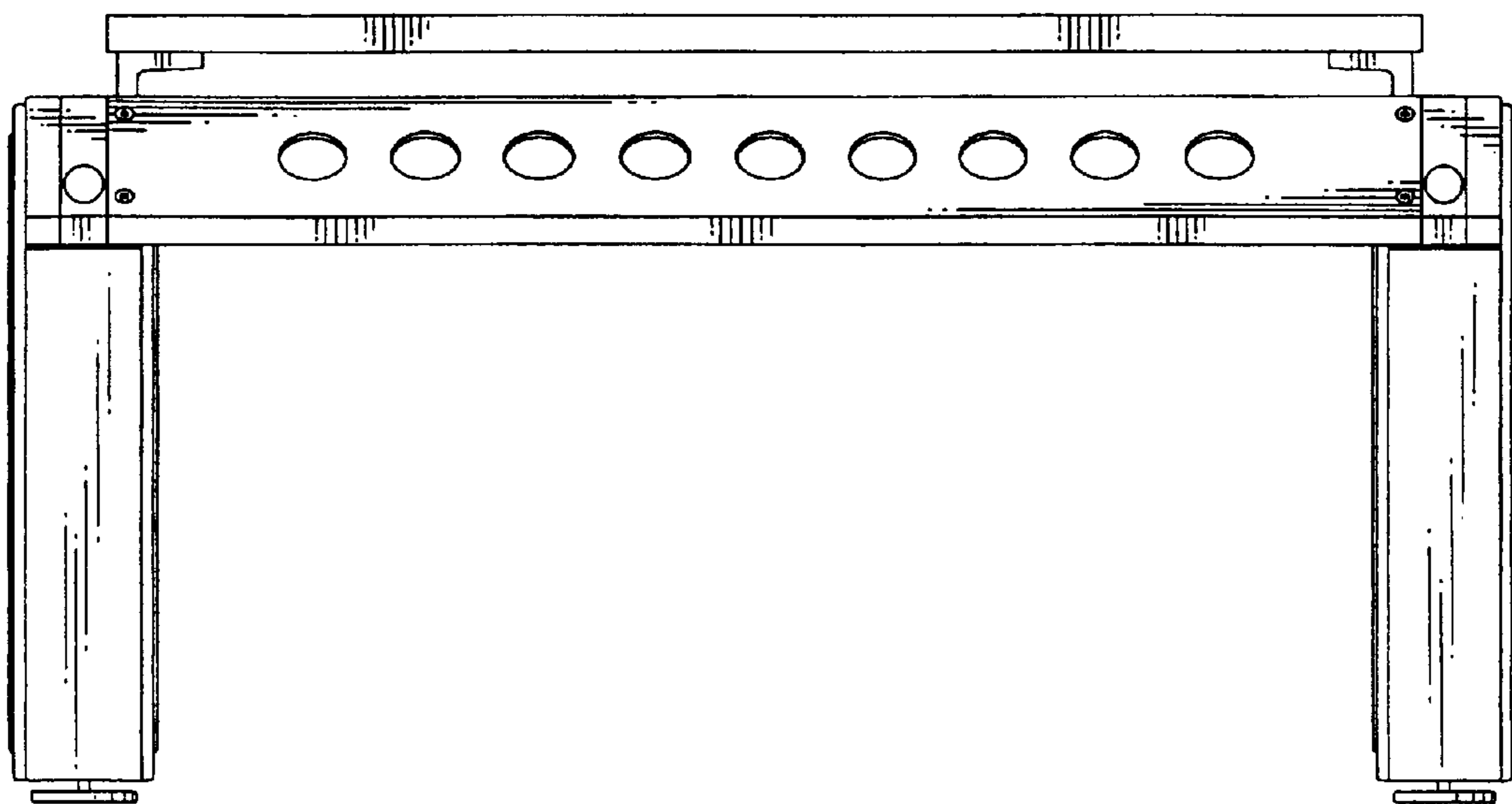

FIG. 3

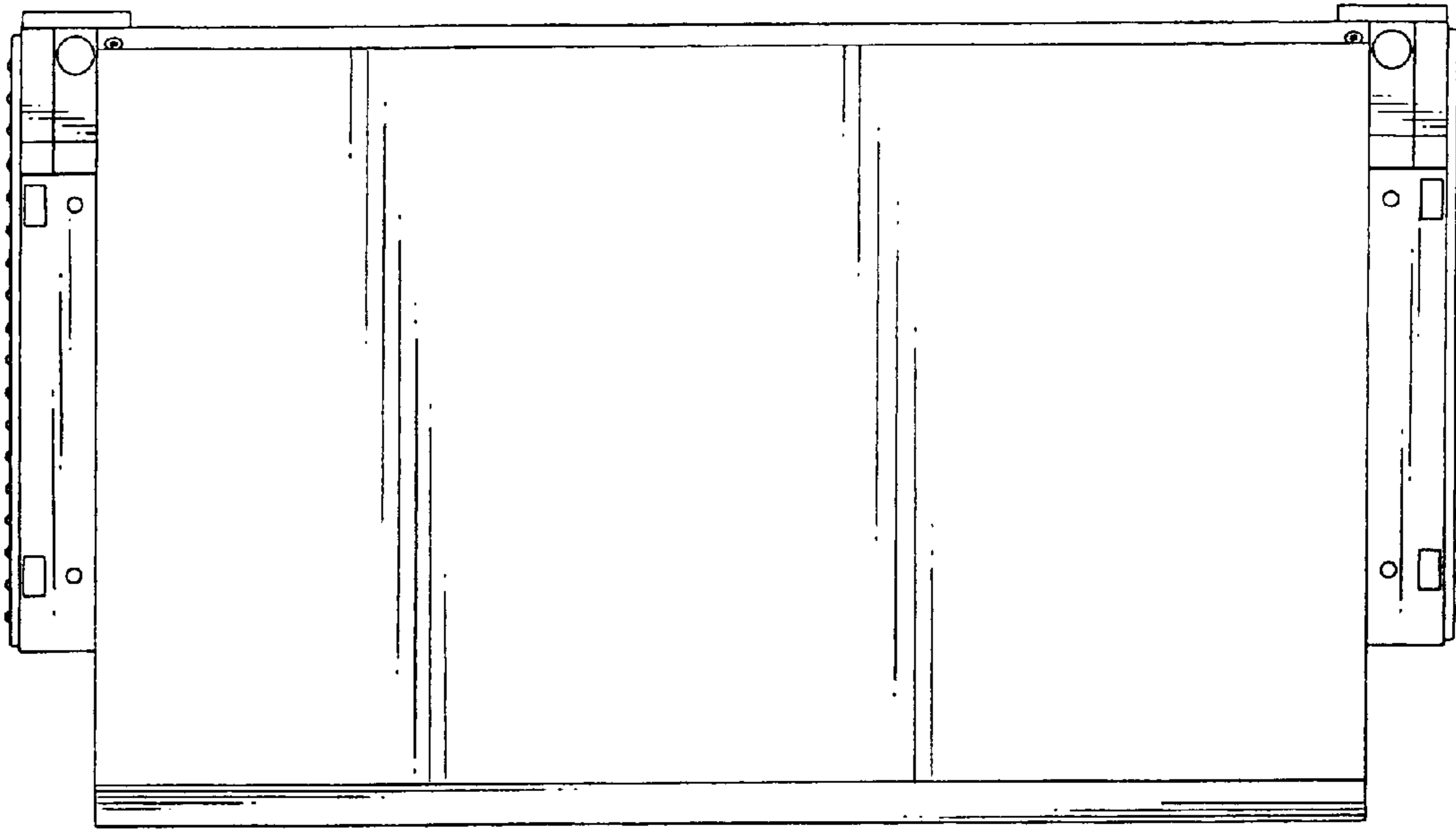

FIG. 4

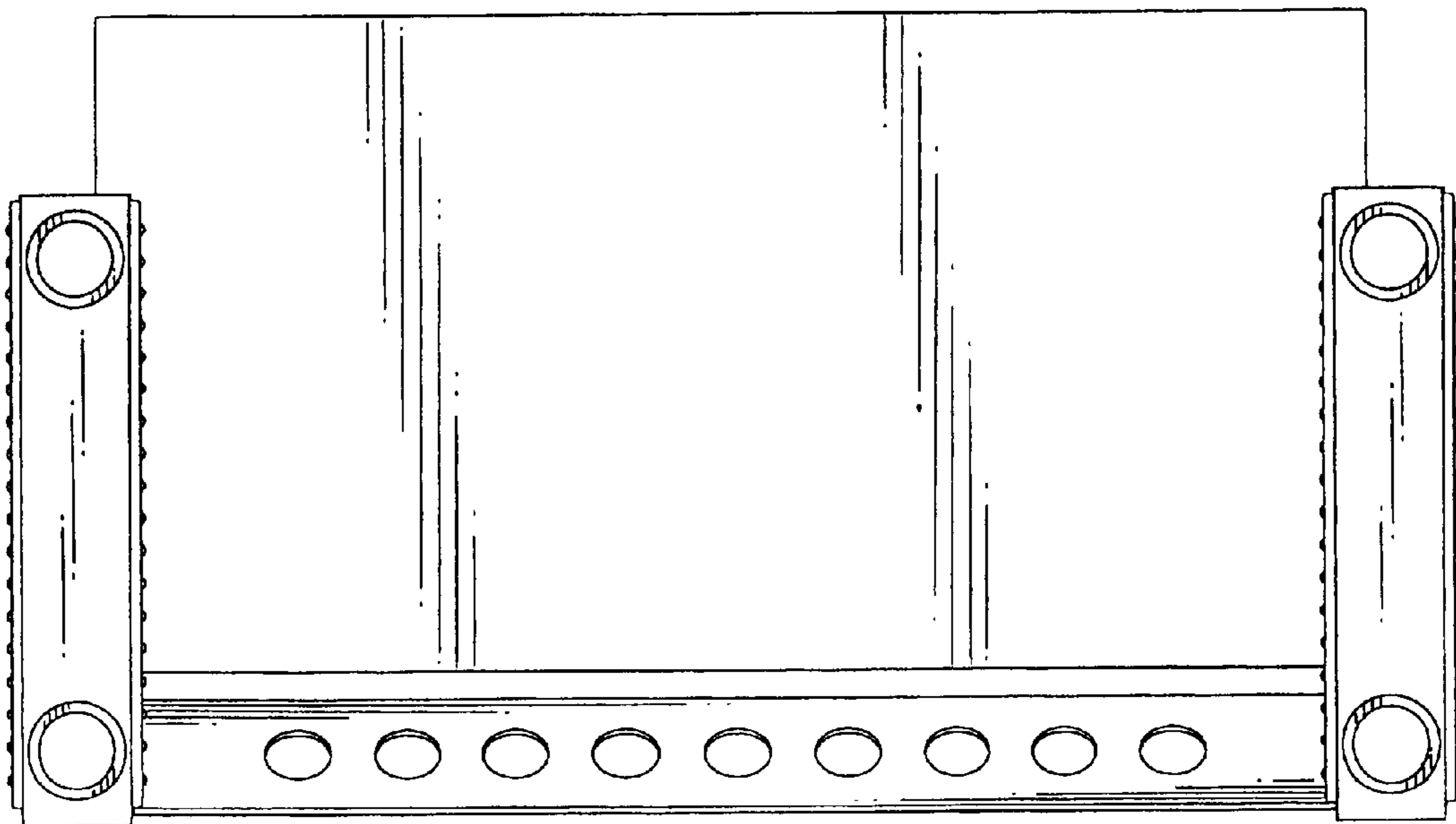

FIG. 5

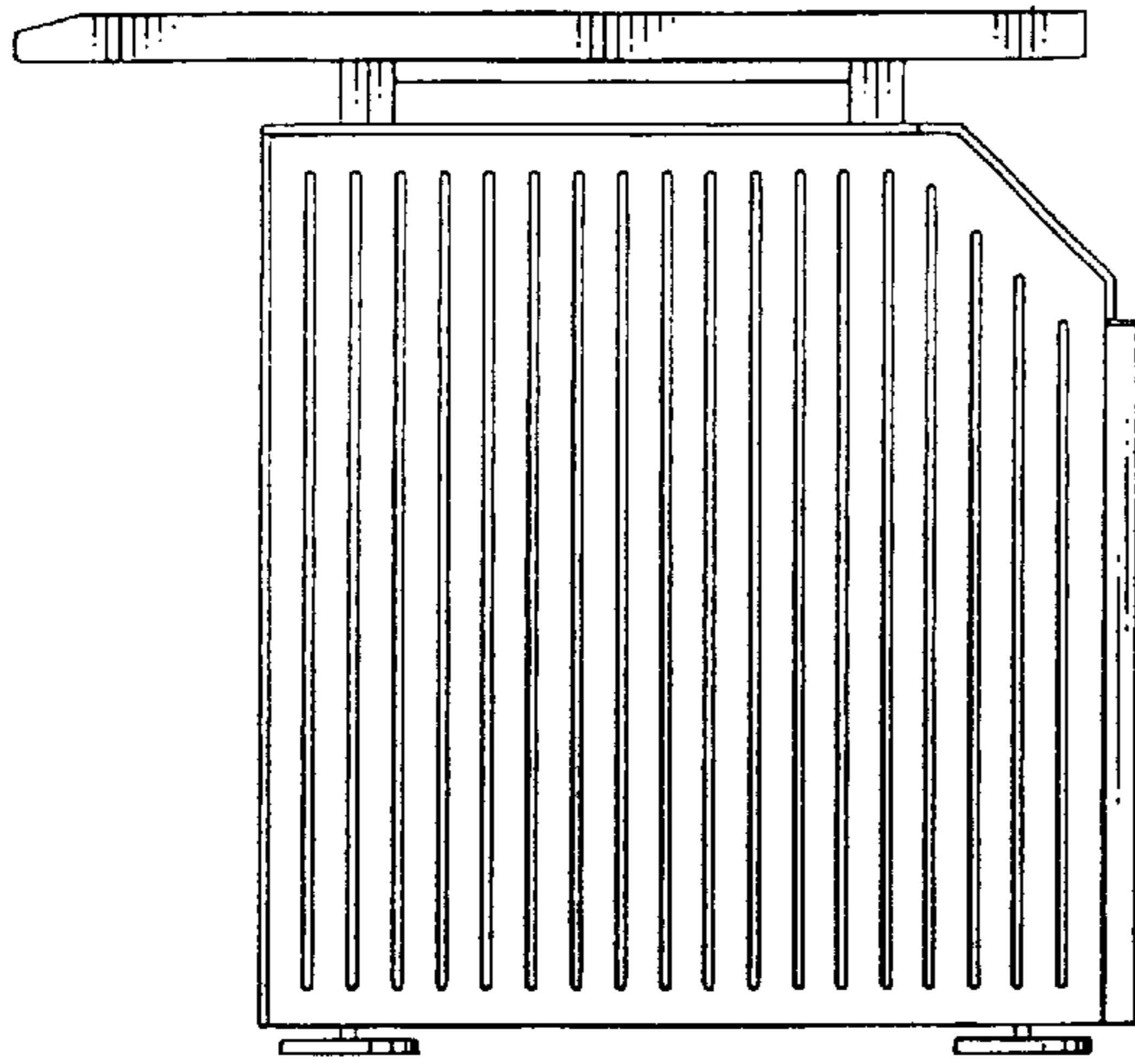

FIG. 6

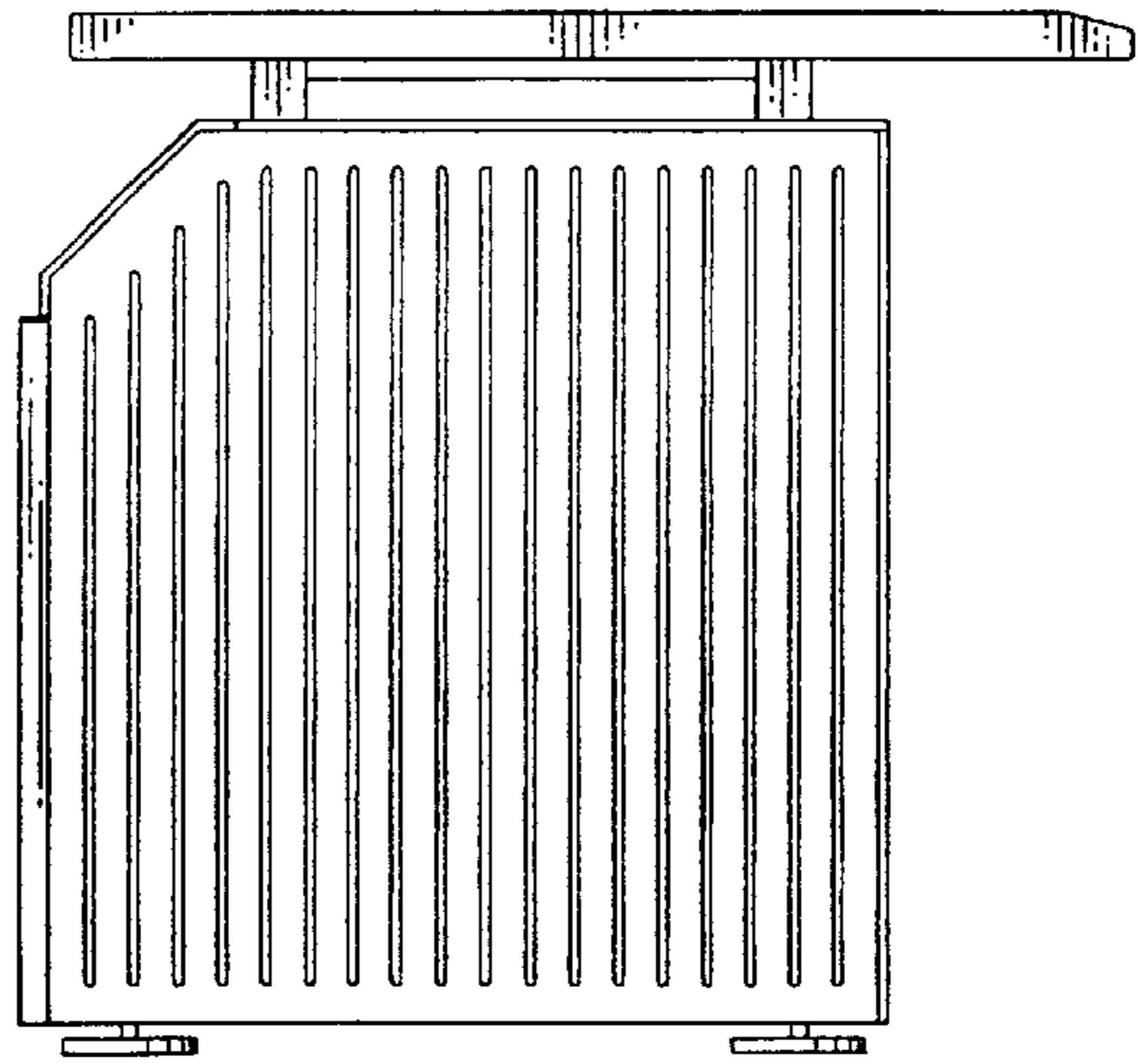

FIG. 7

