



US00D474023S

(12) **United States Design Patent**
Vasudeva

(10) **Patent No.:** **US D474,023 S**

(45) **Date of Patent:** **** May 6, 2003**

(54) **HOLDER FOR DRILL BITS AND THE LIKE**

(75) Inventor: **Kailash C. Vasudeva, Waterloo (CA)**

(73) Assignee: **Maxtech Manufacturing Inc., Waterloo (CA)**

(**) Term: **14 Years**

(21) Appl. No.: **29/163,543**

(22) Filed: **Jul. 9, 2002**

Related U.S. Application Data

(62) Division of application No. 29/141,441, filed on May 8, 2001, now Pat. No. Des. 464,486.

(51) **LOC (7) Cl.** **03-01**

(52) **U.S. Cl.** **D3/315; D9/415**

(58) **Field of Search** **D3/315; D9/415, D9/414; D8/71; 206/349, 372, 373, 377, 379**

(56) **References Cited**

U.S. PATENT DOCUMENTS

D394,806 S	6/1998	Budert	D9/415
5,816,401 A	10/1998	Vasudeva et al.	206/377
D408,281 S	4/1999	Chen	D9/415
5,918,741 A	7/1999	Vasudeva	206/376
D412,438 S	8/1999	Kopala	D9/415
D412,844 S	8/1999	Kopala	D9/415
D413,260 S	8/1999	Vasudeva	D9/415
D418,406 S	1/2000	Liao	D9/341
D433,627 S	11/2000	Vasudeva	D9/415

FOREIGN PATENT DOCUMENTS

WO WO 01/24976 4/2001

Primary Examiner—Philip S. Hyder

(74) *Attorney, Agent, or Firm*—R. Craig Armstrong; L. Anne Kinsman; Borden Ladner Gervais LLP

(57) **CLAIM**

I claim the ornamental design for a holder for drill bits and the like, as shown and described.

DESCRIPTION

FIG. 1 is a perspective view of a first variant of a holder for drill bits and the like.

FIG. 2 is a top plan view of the first variant of the holder for drill bits and the like.

FIG. 3 is a side view of the first variant of the holder for drill bits and the like, seen from a latch side.

FIG. 4 is a front view of the first variant of the holder for drill bits and the like.

FIG. 5 is a bottom plan view of the first variant of the holder for drill bits and the like.

FIG. 6 is a side view of the first variant of the holder for drill bits and the like, seen from a hinge side.

FIG. 7 is a back view of the first variant of the holder for drill bits and the like.

FIG. 8 is a perspective view of a second variant of a holder for drill bits and the like.

FIG. 9 is a top plan view of the second variant of the holder for drill bits and the like.

FIG. 10 is a side view of the second variant of the holder for drill bits and the like, seen from a latch side.

FIG. 11 is a front view of the second variant of the holder for drill bits and the like.

FIG. 12 is a bottom plan view of the second variant of the holder for drill bits and the like.

FIG. 13 is a side view of the second variant of the holder for drill bits and the like, seen from a hinge side; and,

FIG. 14 is a back view of the second variant of the holder for drill bits and the like.

1 Claim, 6 Drawing Sheets

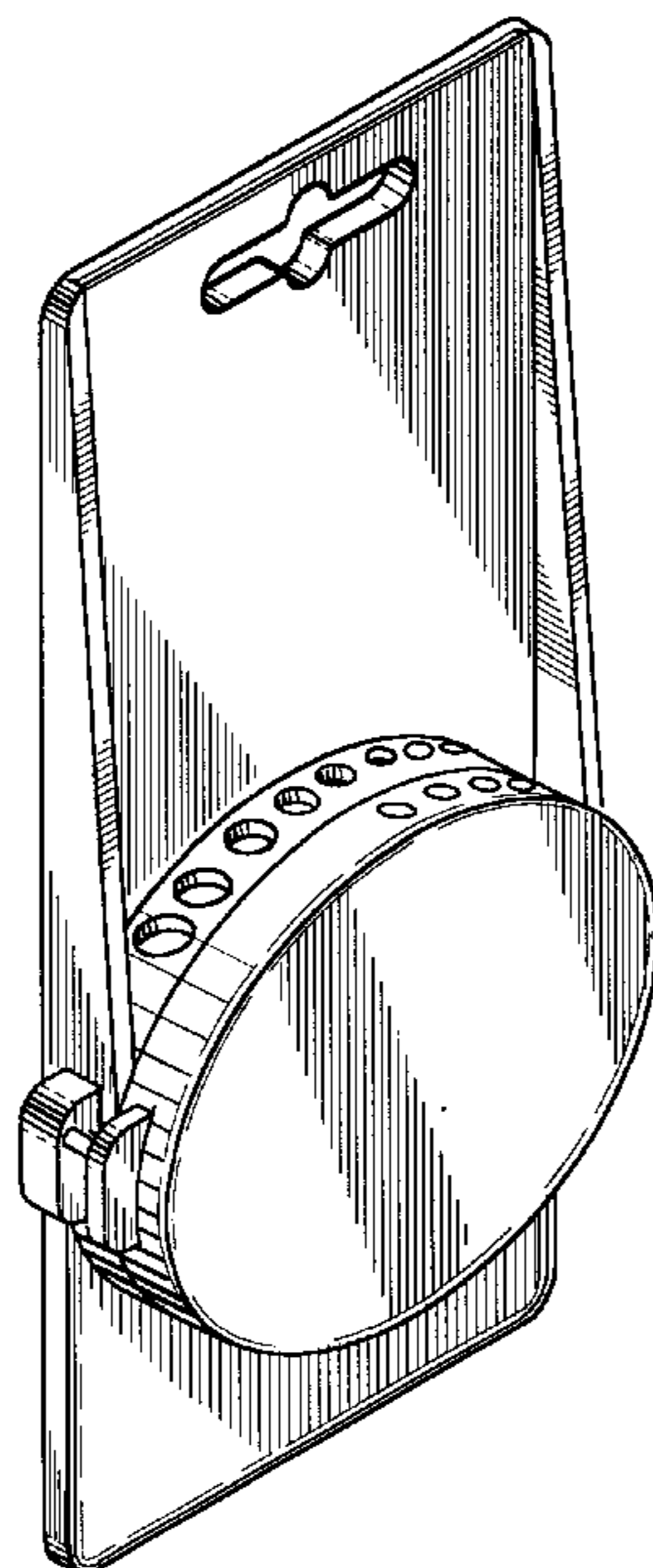

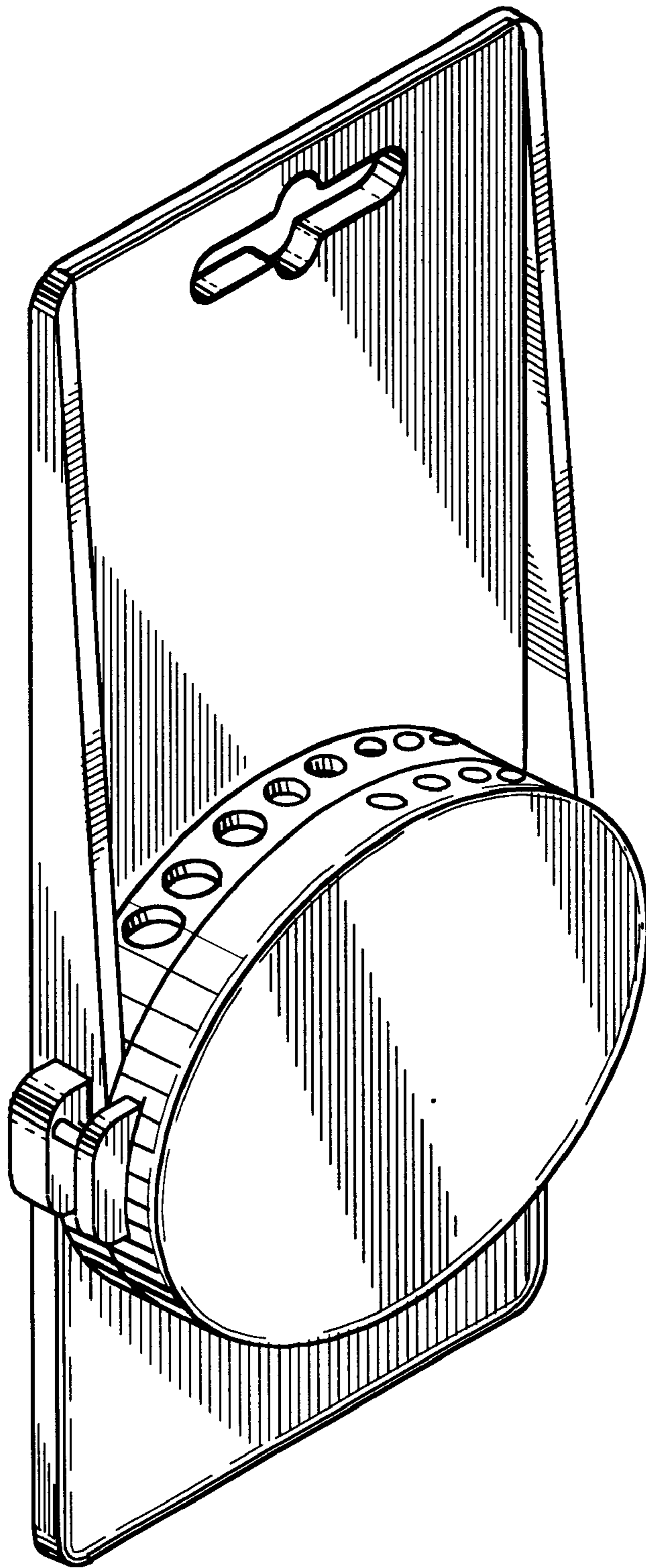

FIG.1

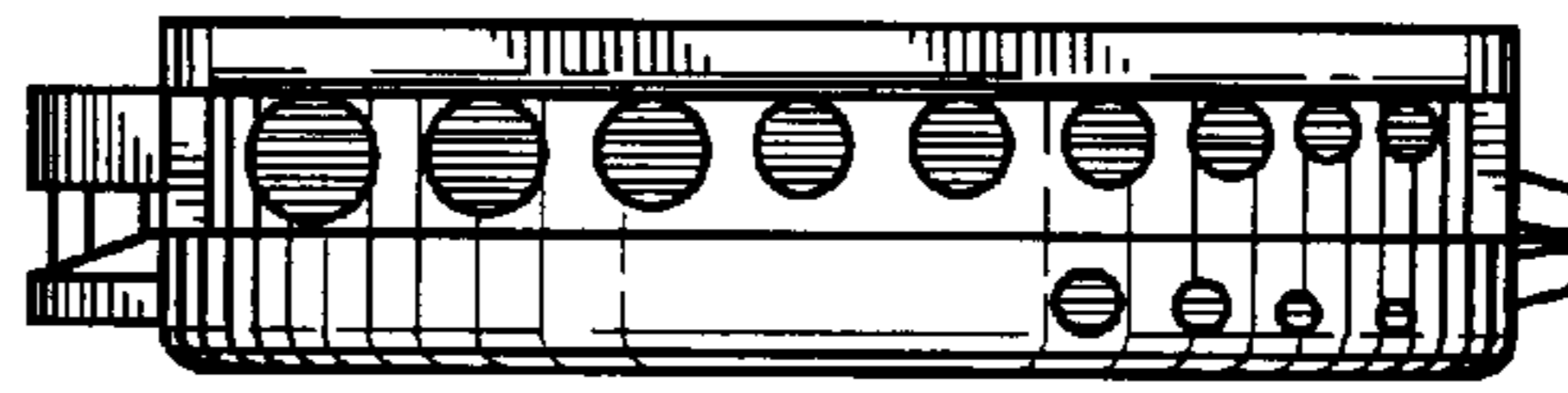

FIG. 2

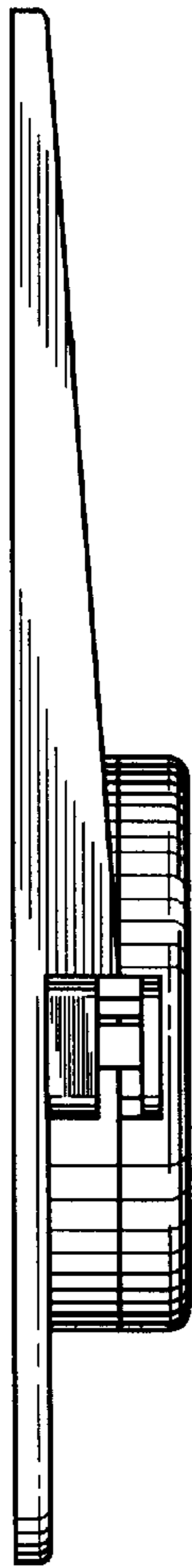

FIG. 3

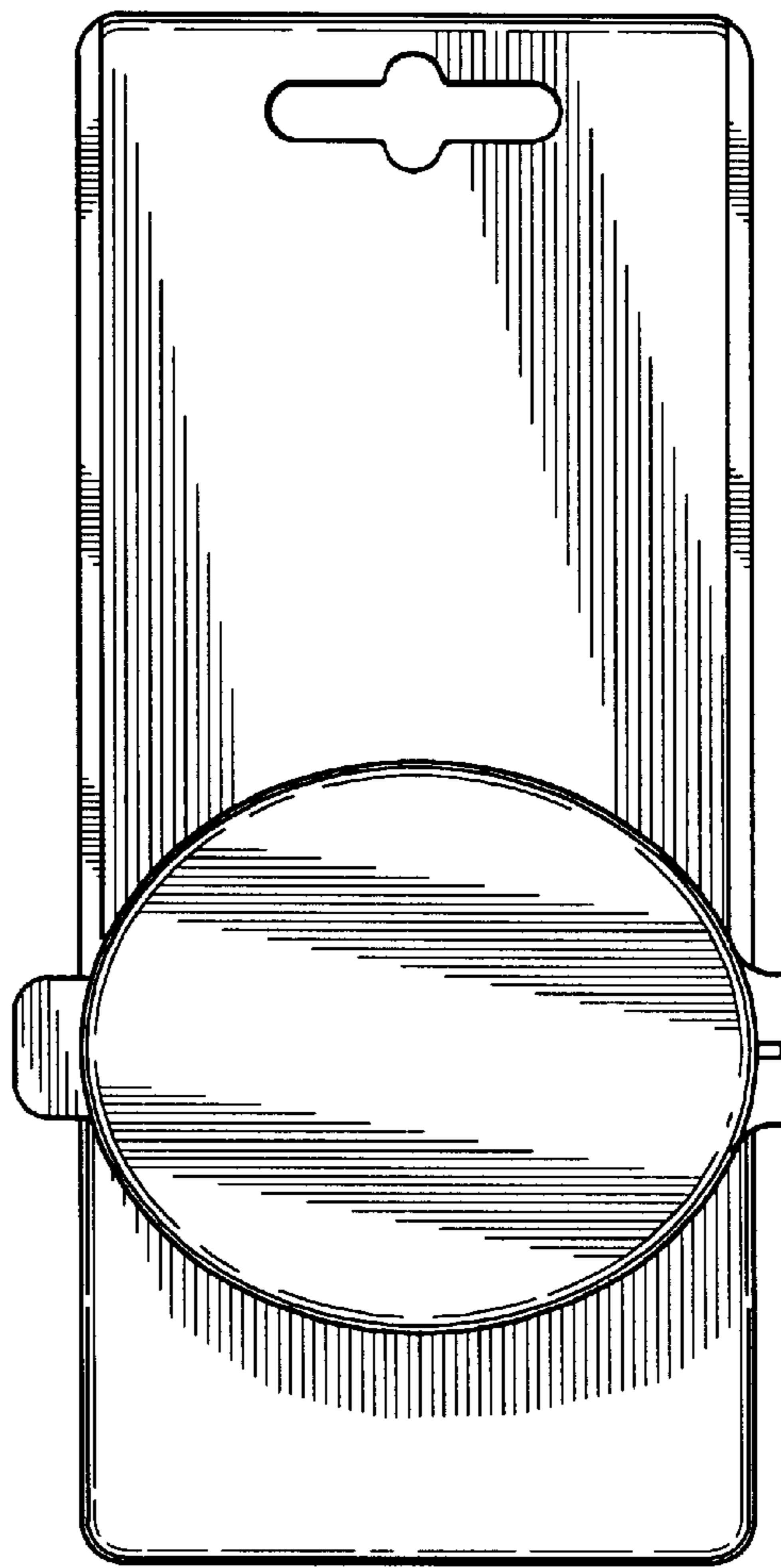

FIG. 4

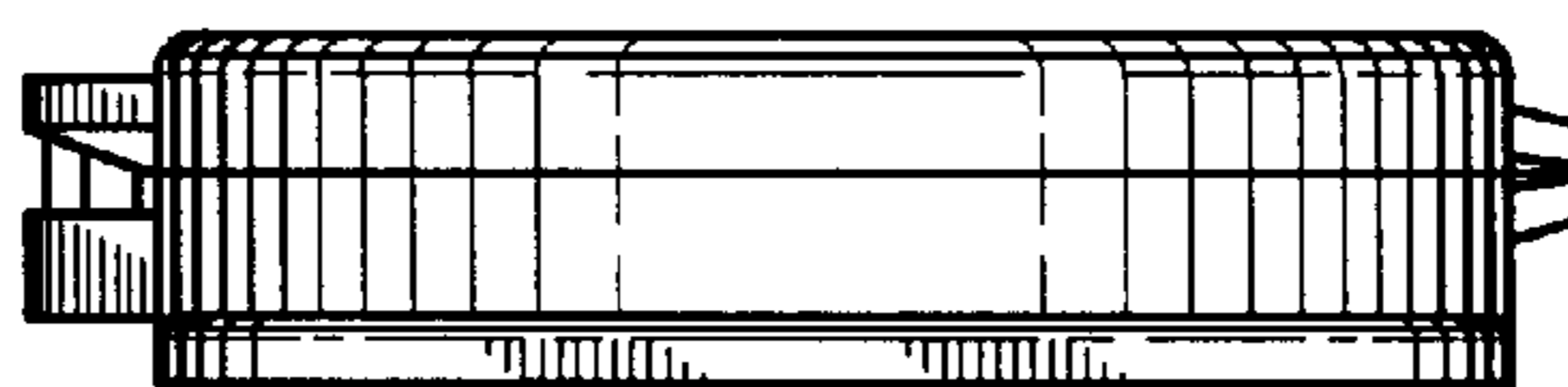

FIG. 5

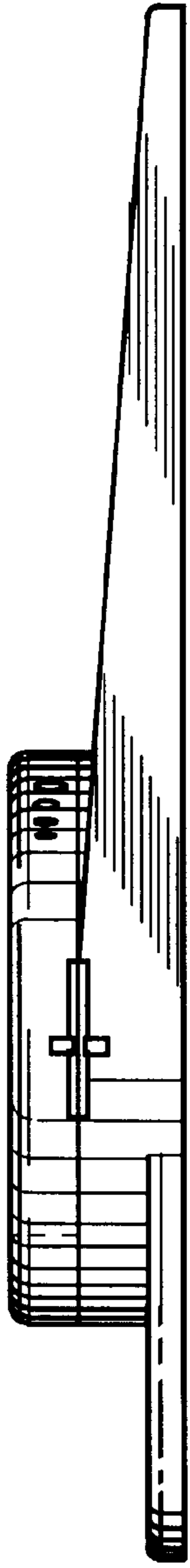

FIG. 6

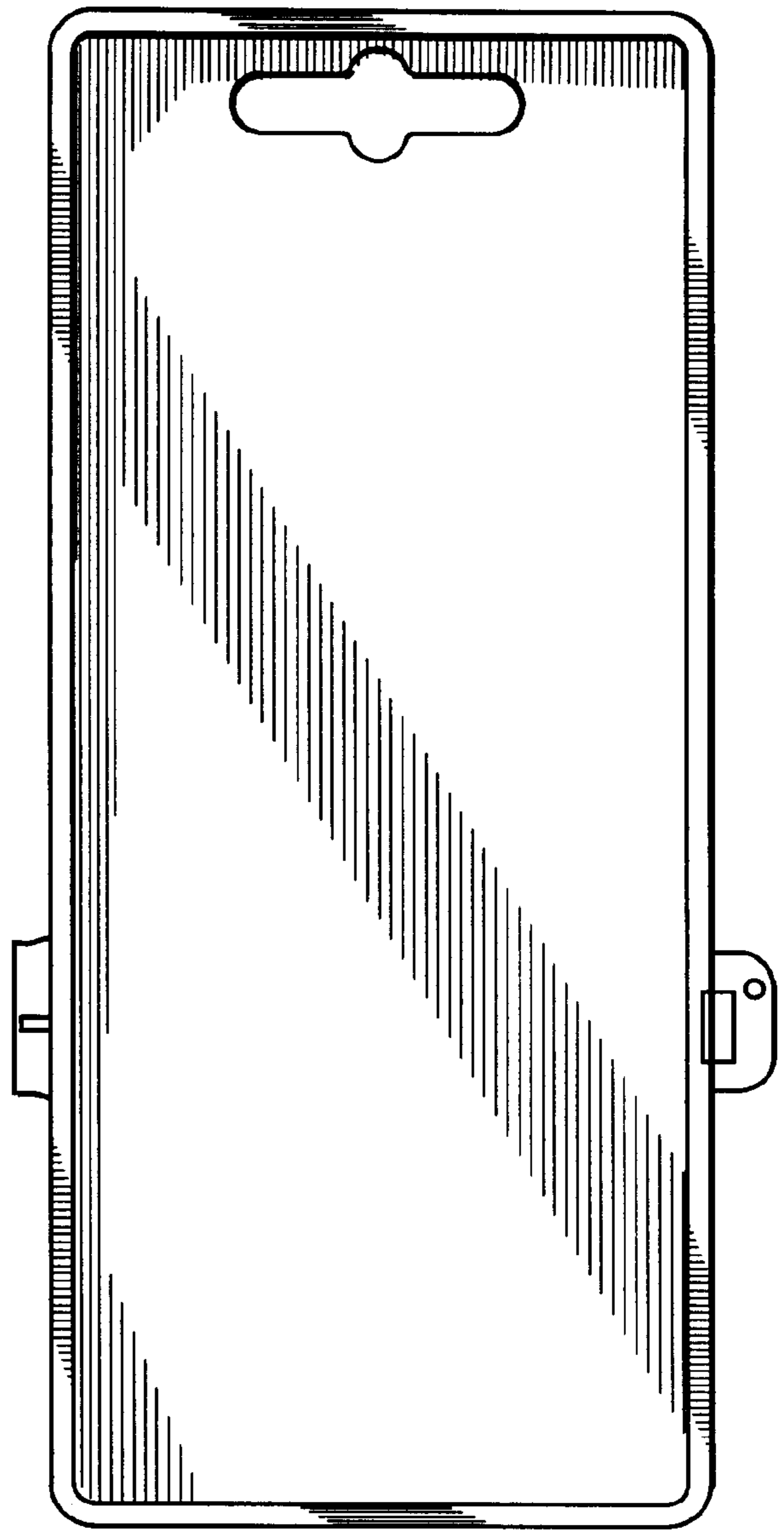

FIG. 7

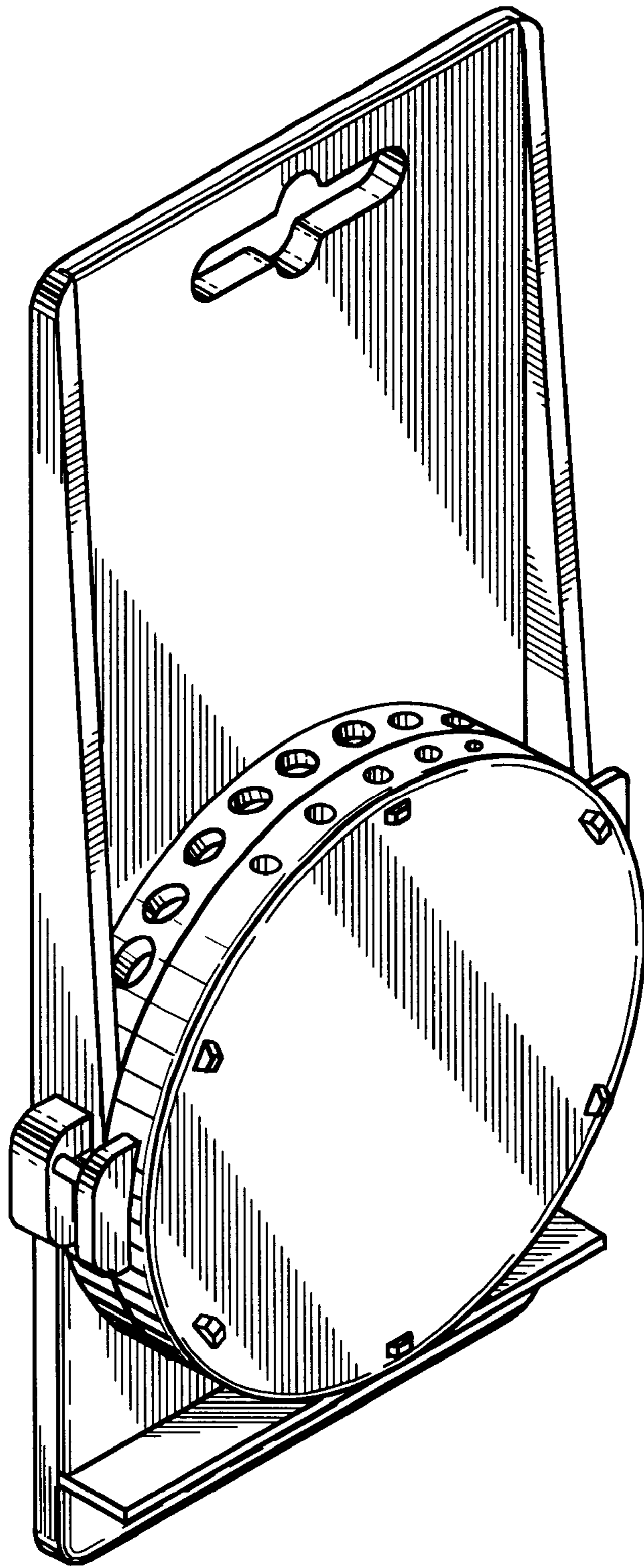

FIG.8

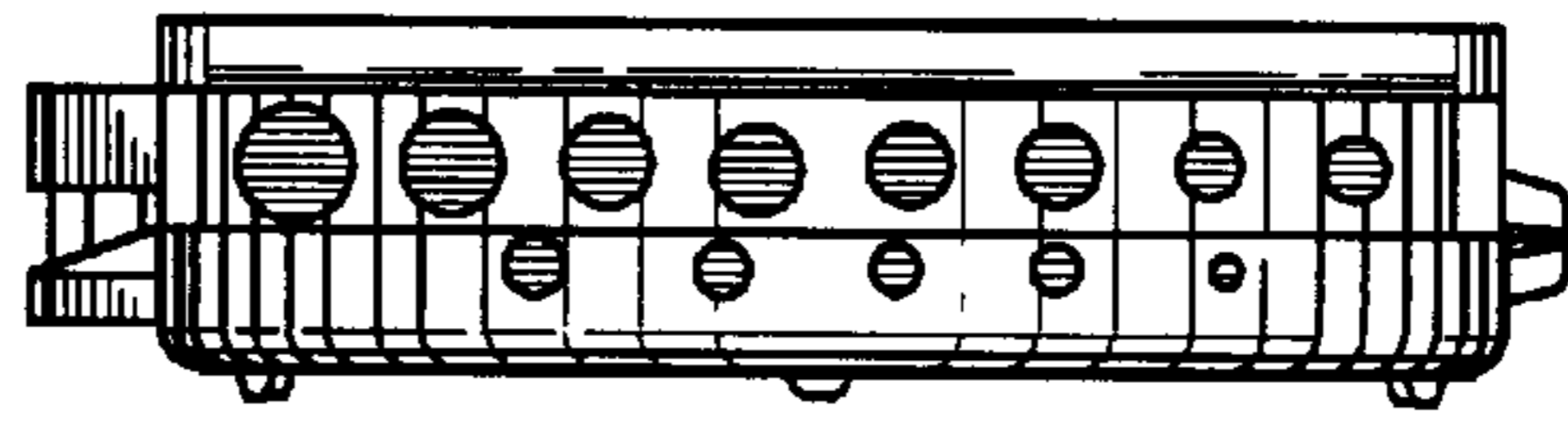

FIG. 9

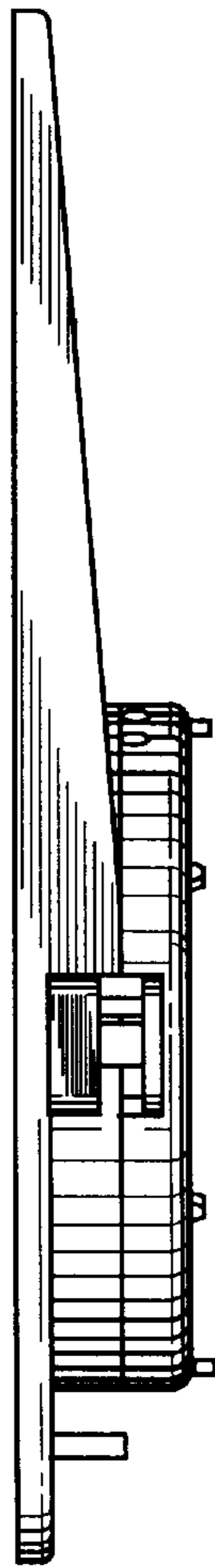

FIG. 10

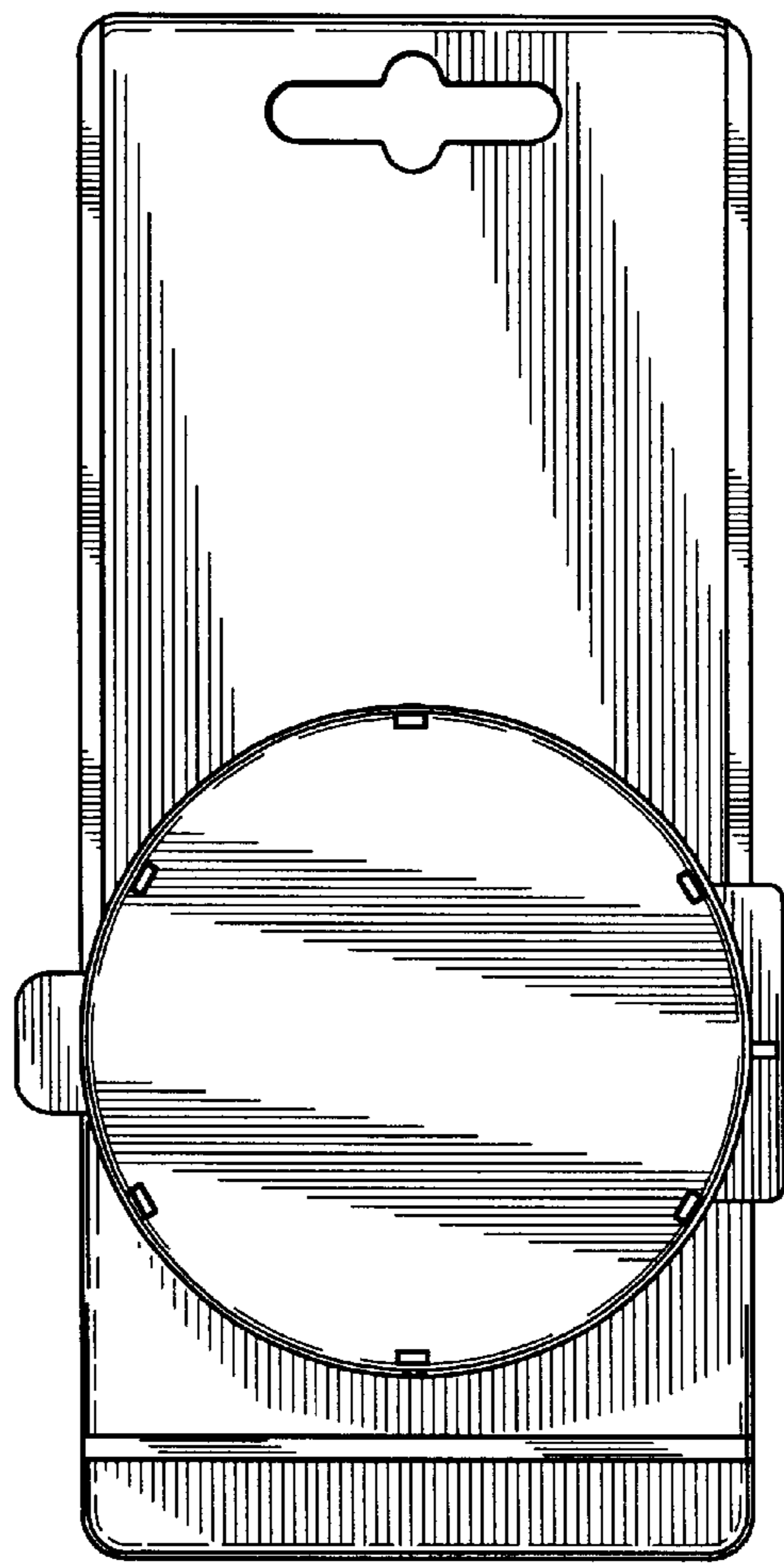

FIG. 11

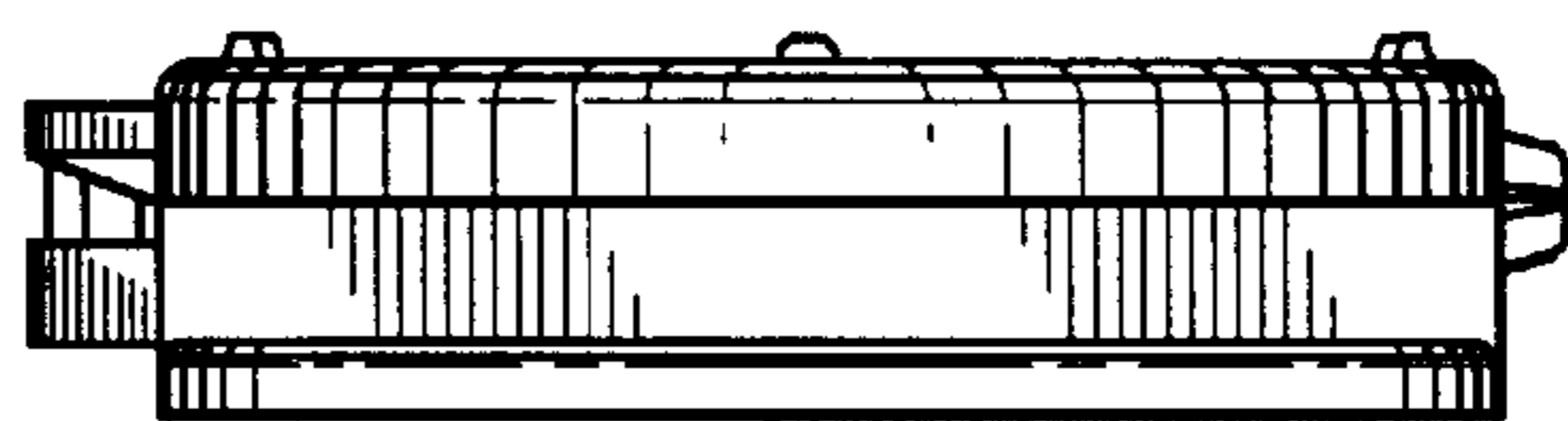

FIG. 12

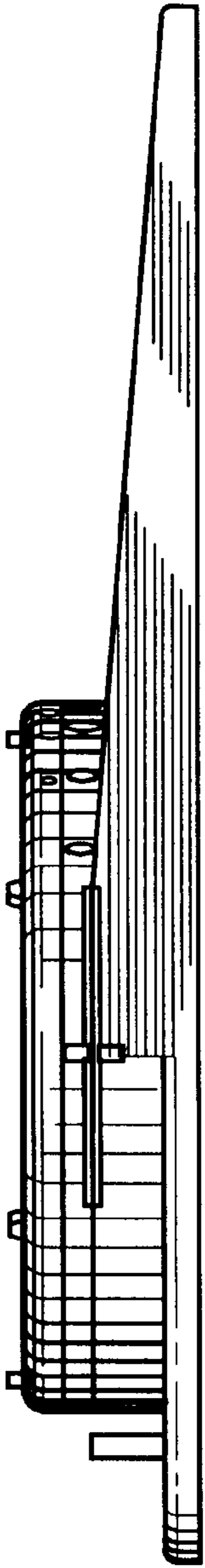

FIG. 13

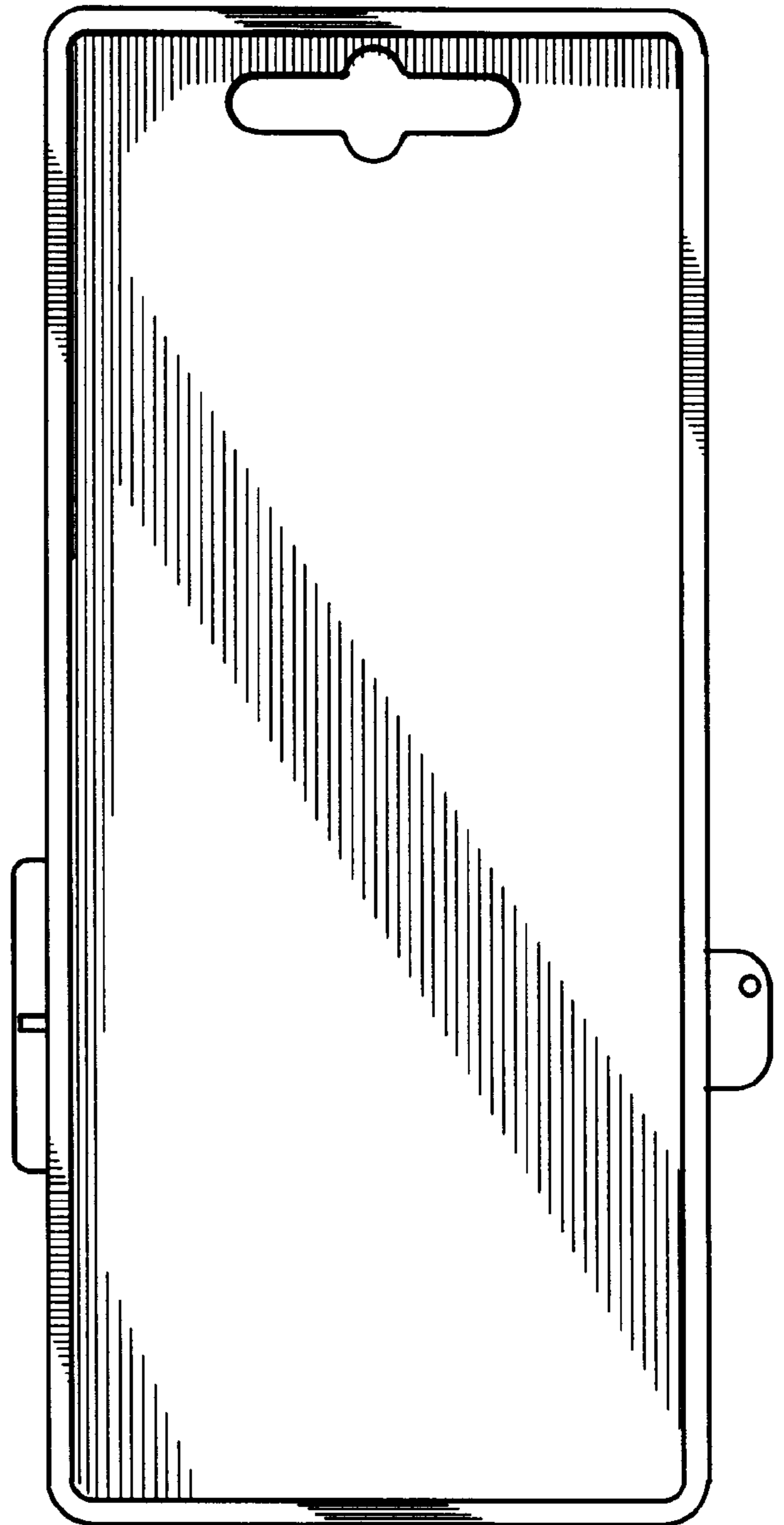

FIG. 14