



US00D473987S

(12) **United States Design Patent**
Foersterling

(10) **Patent No.:** **US D473,987 S**

(45) **Date of Patent:** **** Apr. 29, 2003**

(54) **CREASE REMOVER FOR CLOTH**

3,811,208 A * 5/1974 Vieceli et al. 38/77.8

4,206,340 A * 6/1980 Osrow et al. 38/69

4,496,826 A * 1/1985 Osrow 38/69

(75) Inventor: **Klaus Foersterling**, Seligenstadt (DE)

(73) Assignee: **Calor S.A.** (FR)

* cited by examiner

(**) Term: **14 Years**

Primary Examiner—Jennifer Rivard

(74) *Attorney, Agent, or Firm*—Cantor Colburn LLP

(21) Appl. No.: **29/161,889**

(22) Filed: **Jun. 5, 2002**

(57) **CLAIM**

The ornamental design for a crease remover for cloth, as shown and described.

Related U.S. Application Data

(62) Division of application No. 29/133,015, filed on Nov. 20, 2000, now Pat. No. Des. 465,309.

DESCRIPTION

(30) **Foreign Application Priority Data**

May 18, 2000 (FR) 00 3078

FIG. 1 is a top and front perspective view of a crease remover for cloth, showing my new design;

FIG. 2 is a front elevational view thereof;

(51) **LOC (7) Cl.** **07-05**

(52) **U.S. Cl.** **D32/35; D32/69**

FIG. 3 is a side elevational view thereof taken from the right of FIG. 2;

(58) **Field of Search** D32/35, 69, 71, D32/17; 68/222; 38/69, 74, 77.1, 77.5, 77.8, 77.7, 88, 90, 94; 15/344; 392/454

FIG. 4 is a side elevational view thereof taken from the left of FIG. 2;

FIG. 5 is a rear elevational view thereof;

FIG. 6 is a top elevational view thereof; and,

FIG. 7 is a bottom elevational view thereof.

(56) **References Cited**

U.S. PATENT DOCUMENTS

D230,458 S * 2/1974 Hall D32/69

1 Claim, 7 Drawing Sheets

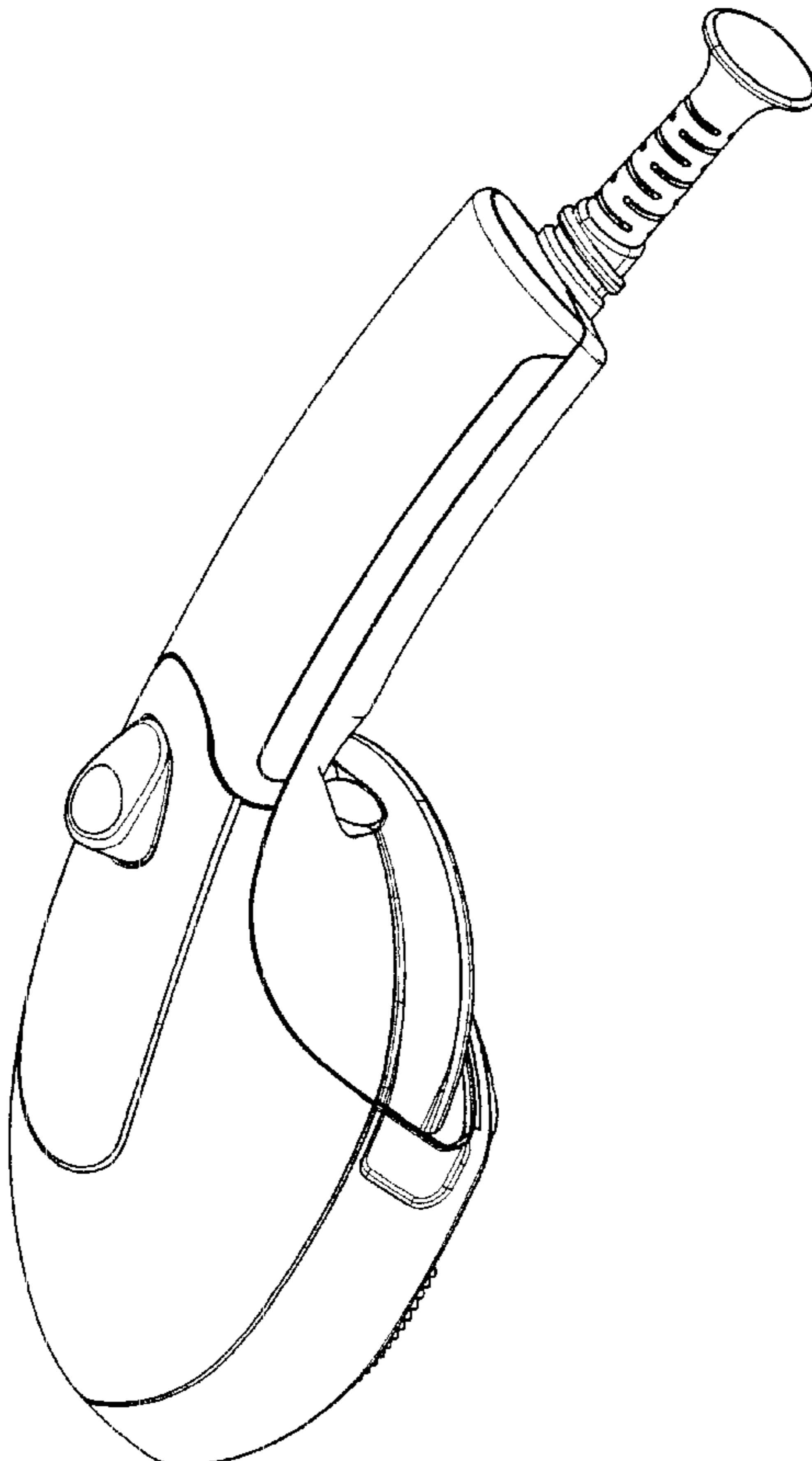

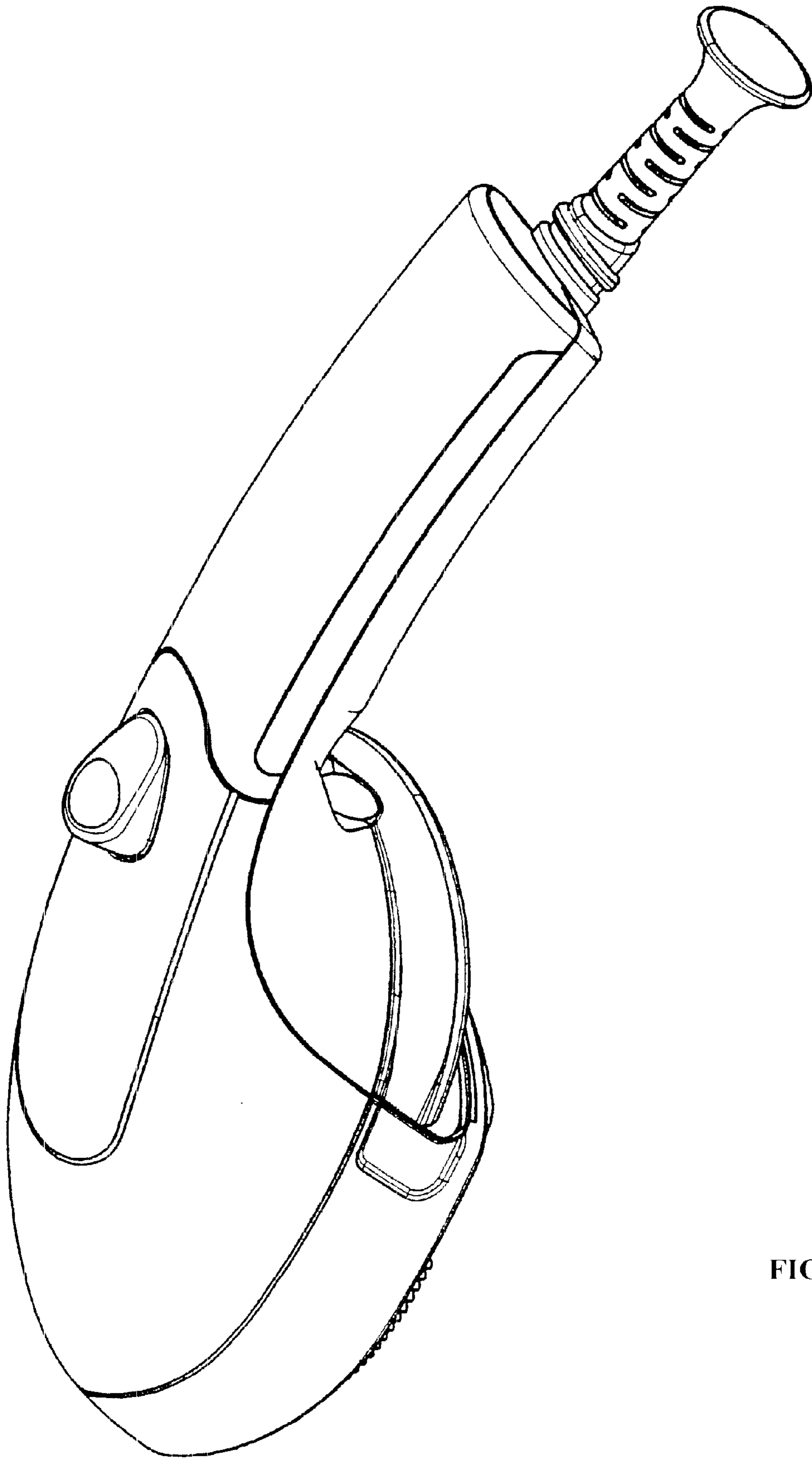

FIGURE 1

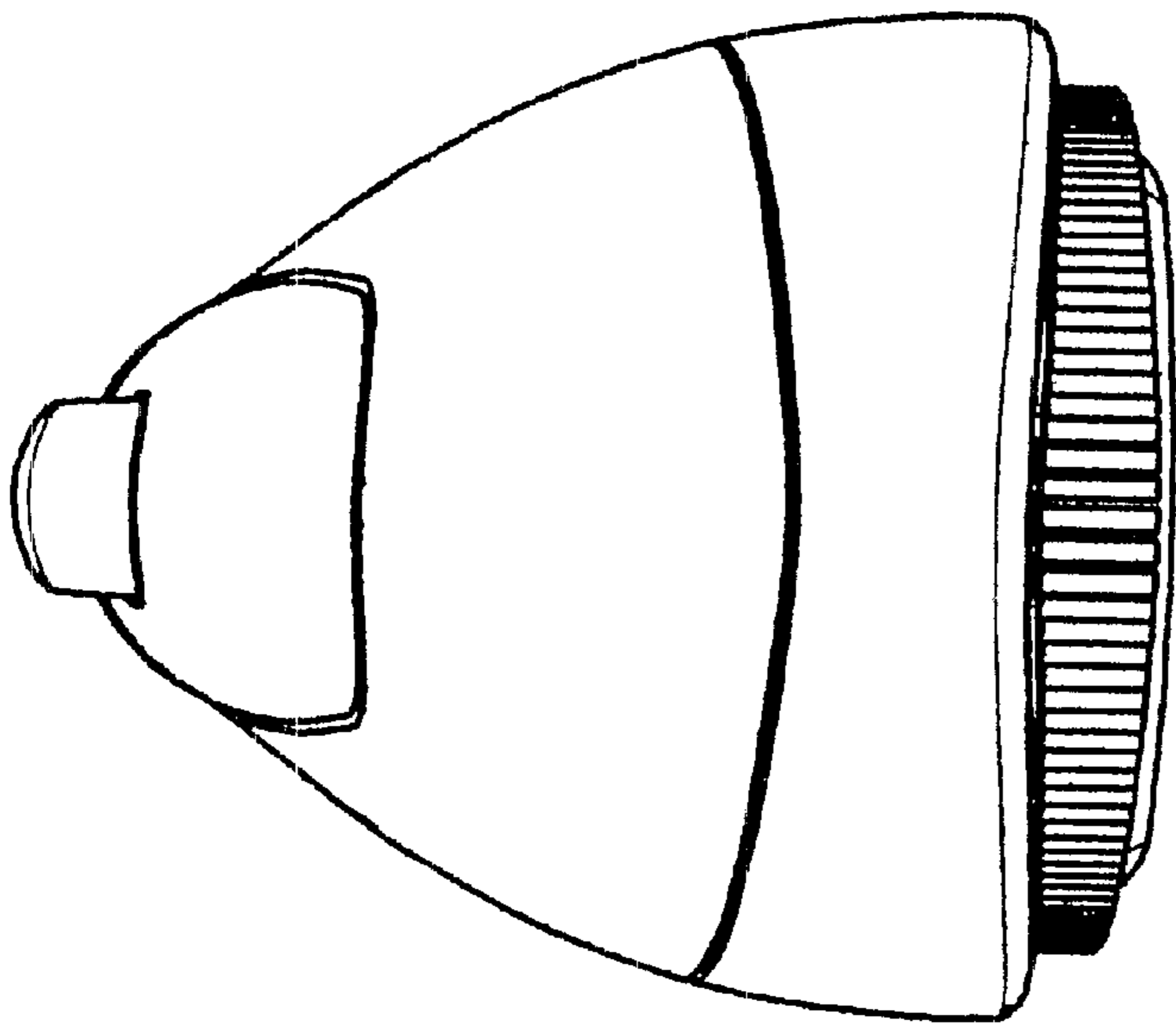

FIGURE 2

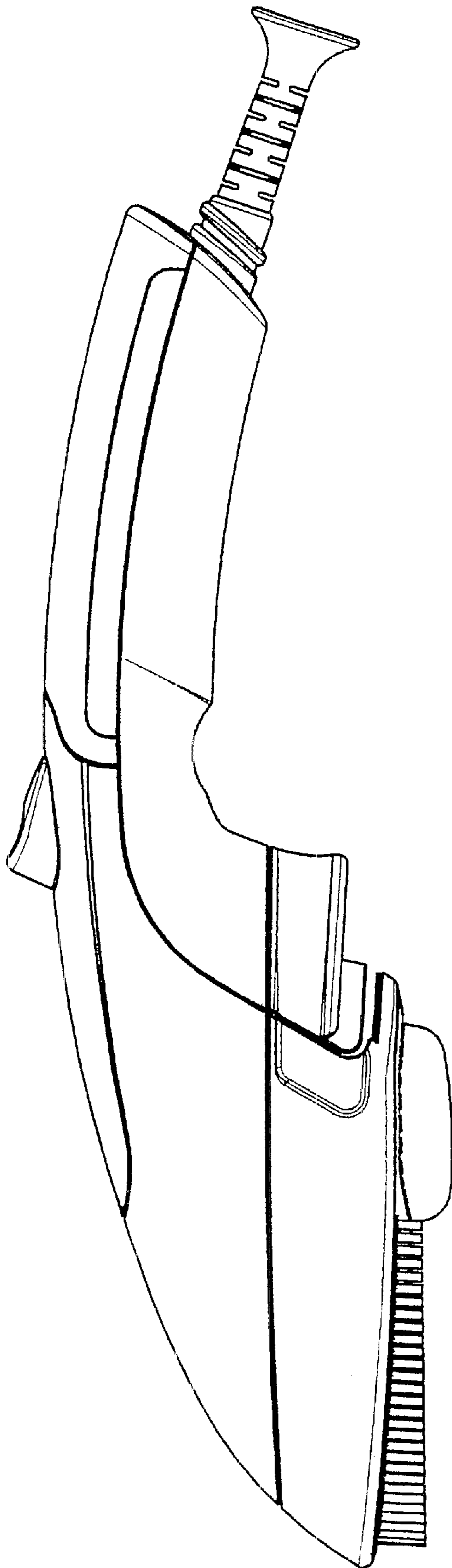

FIGURE 3

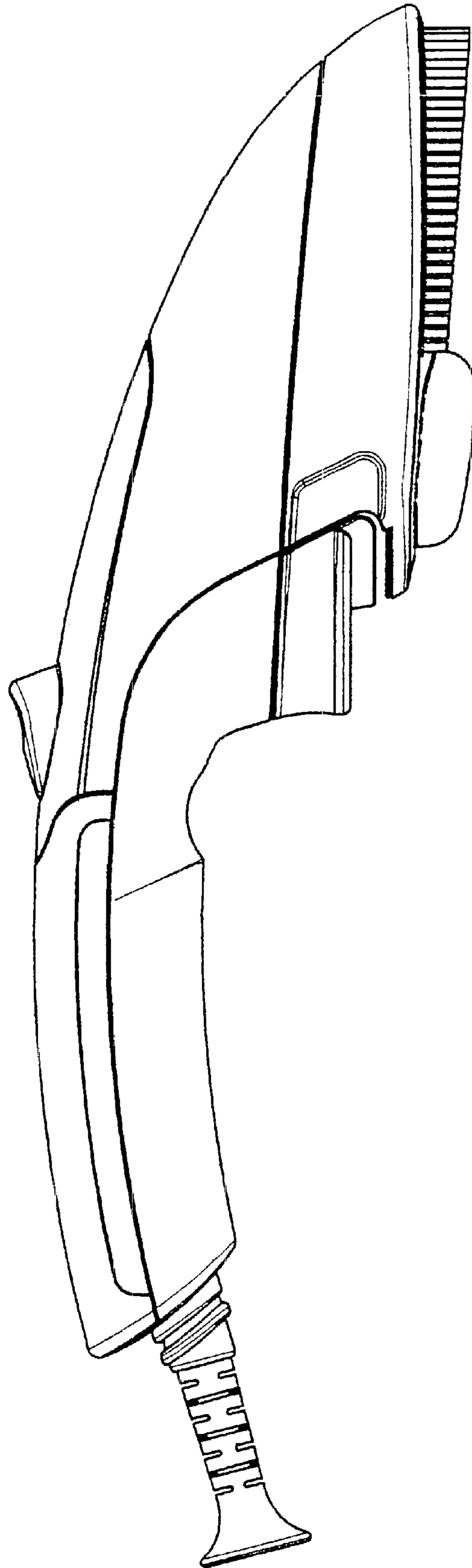

FIGURE 4

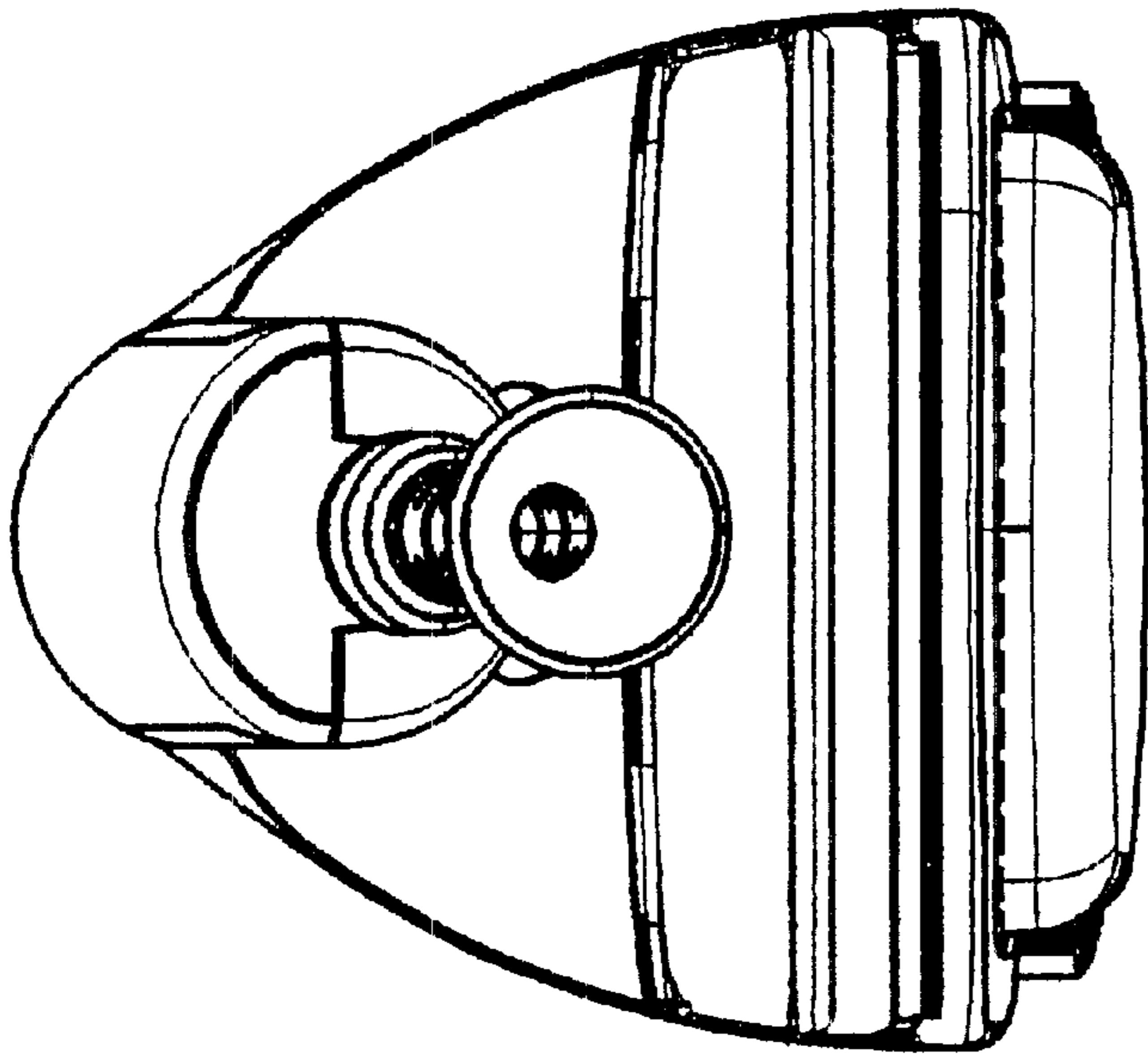

FIGURE 5

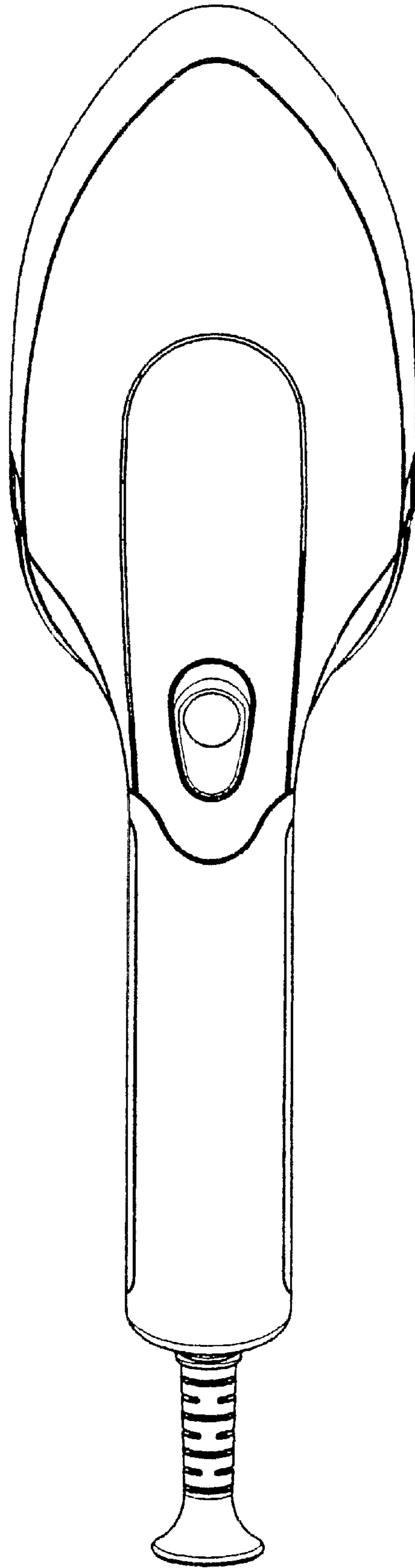

FIGURE 6

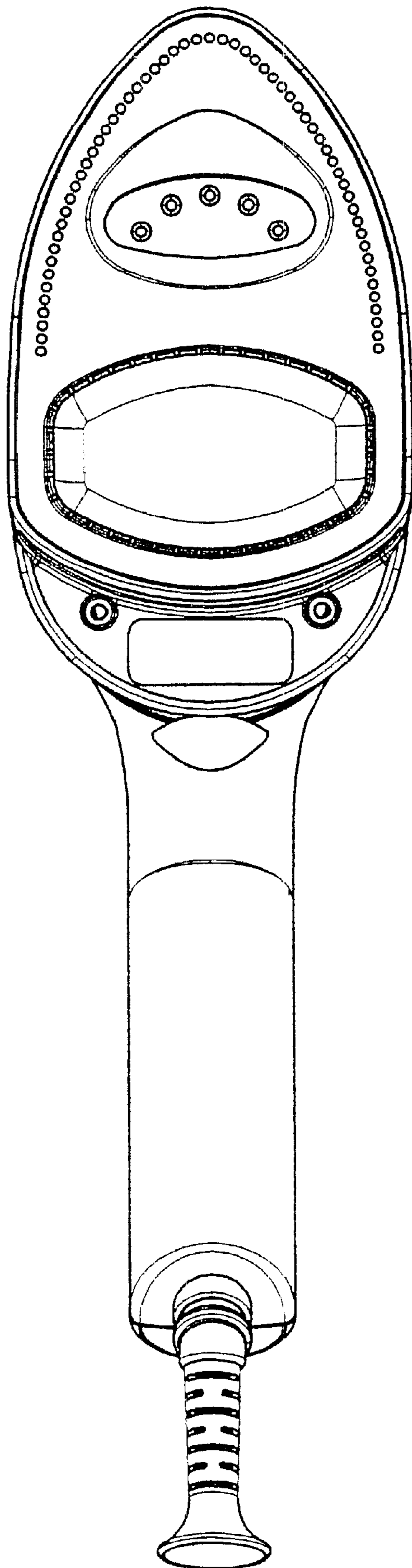

FIGURE 7