



US00D473938S

(12) **United States Design Patent**
Zablotny

(10) **Patent No.:** **US D473,938 S**

(45) **Date of Patent:** **** *Apr. 29, 2003**

(54) **SANDBLAST CABINET**

(76) Inventor: **Terry E. Zablotny**, 856 Cedarbrae Ave., Milton, Ontario (CA), L9T 3X1

(*) Notice: This patent is subject to a terminal disclaimer.

(**) Term: **14 Years**

(21) Appl. No.: **29/137,729**

(22) Filed: **Feb. 28, 2001**

(51) **LOC (7) Cl.** **15-09**

(52) **U.S. Cl.** **D24/124**

(58) **Field of Search** D15/123, 124;
451/38-40, 87-89, 90, 75, 451

(56) **References Cited**

U.S. PATENT DOCUMENTS

3,545,137	A	*	12/1970	Vrana	451/89
D320,607	S	*	10/1991	Smith et al.	D15/124
D323,661	S	*	2/1992	Zwicker	D15/124
5,460,564	A	*	10/1995	Bowes et al.	451/89

* cited by examiner

Primary Examiner—Antoine Duval Davis

(57) **CLAIM**

The ornamental design for a sandblast cabinet, as shown and described.

DESCRIPTION

FIG. 1 Left hand side pattern, no legs, door closed. Note: Right side pattern is mirror image.

FIG. 2 Front view showing large window opening & glove holes.

FIG. 3 Left hand side view w/legs attached, door closed.

FIG. 4 Front view as tilted forward on legs.

FIG. 5 Left hand side view pattern, legs attached, door partially open.

FIG. 6 Rear view, legs attached, door panel closed, hinge showing on left side.

FIG. 7 Front view.

FIG. 8 Top view as tilted forward from FIG. 7 showing hinged door partially open.

FIG. 9 back view, legs attached, door removed.

FIG. 10 Bottom view as tilted backwards from view 7, hinged door partially open.

FIG. 11 Perspective view, left side, front and top; and,

FIG. 12 Perspective rear view w/door removed.

1 Claim, 3 Drawing Sheets

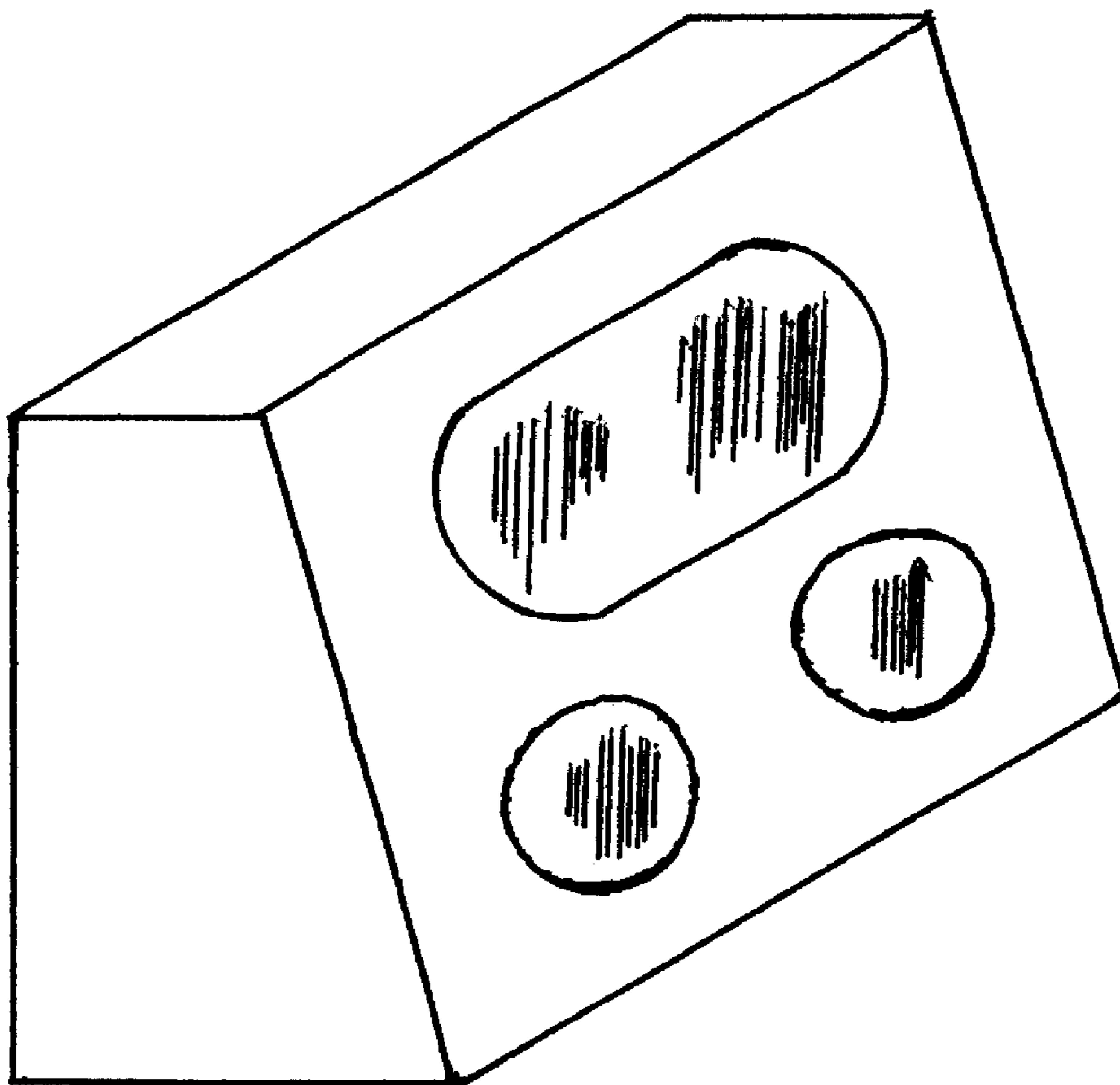

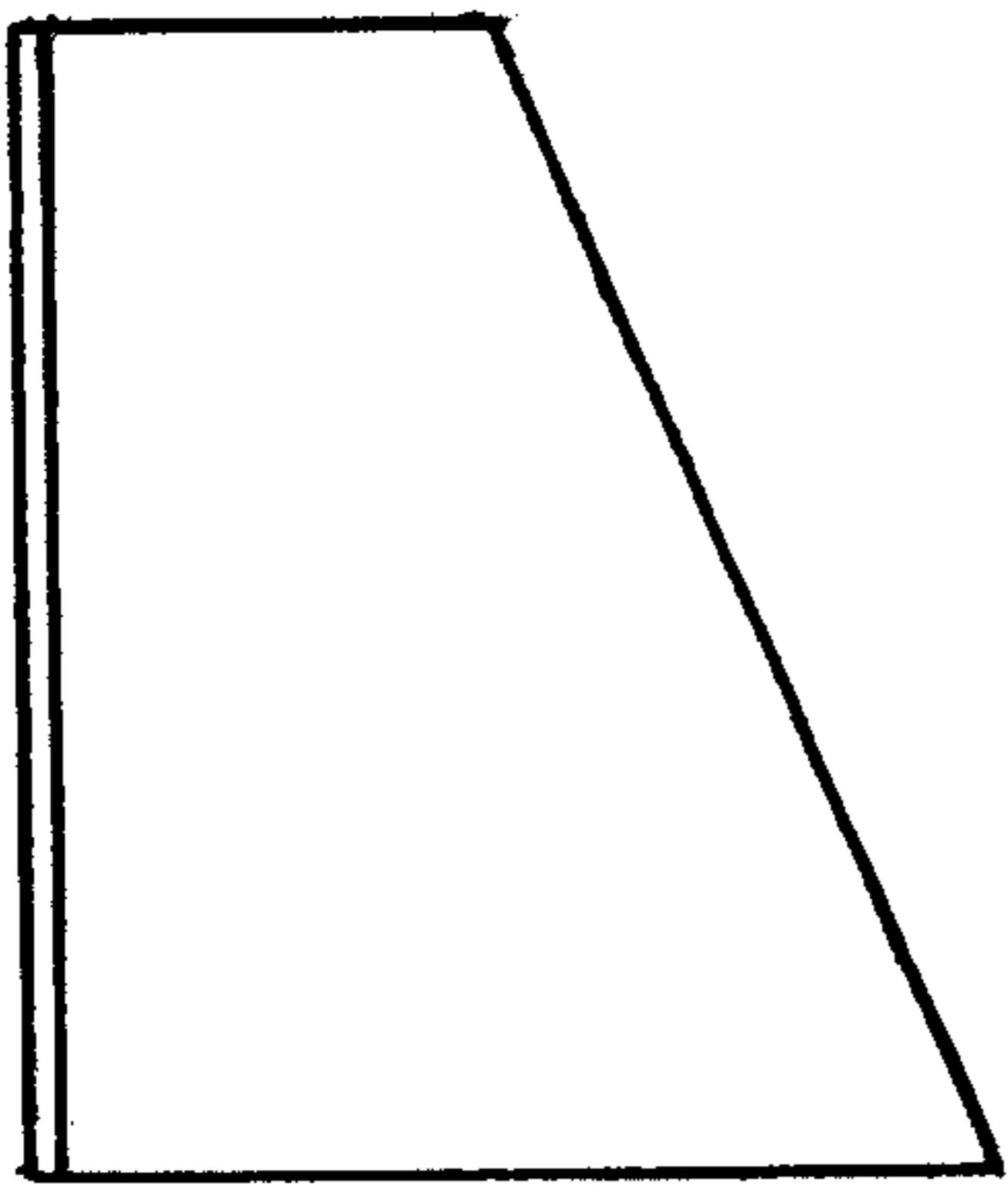

FIG. 1

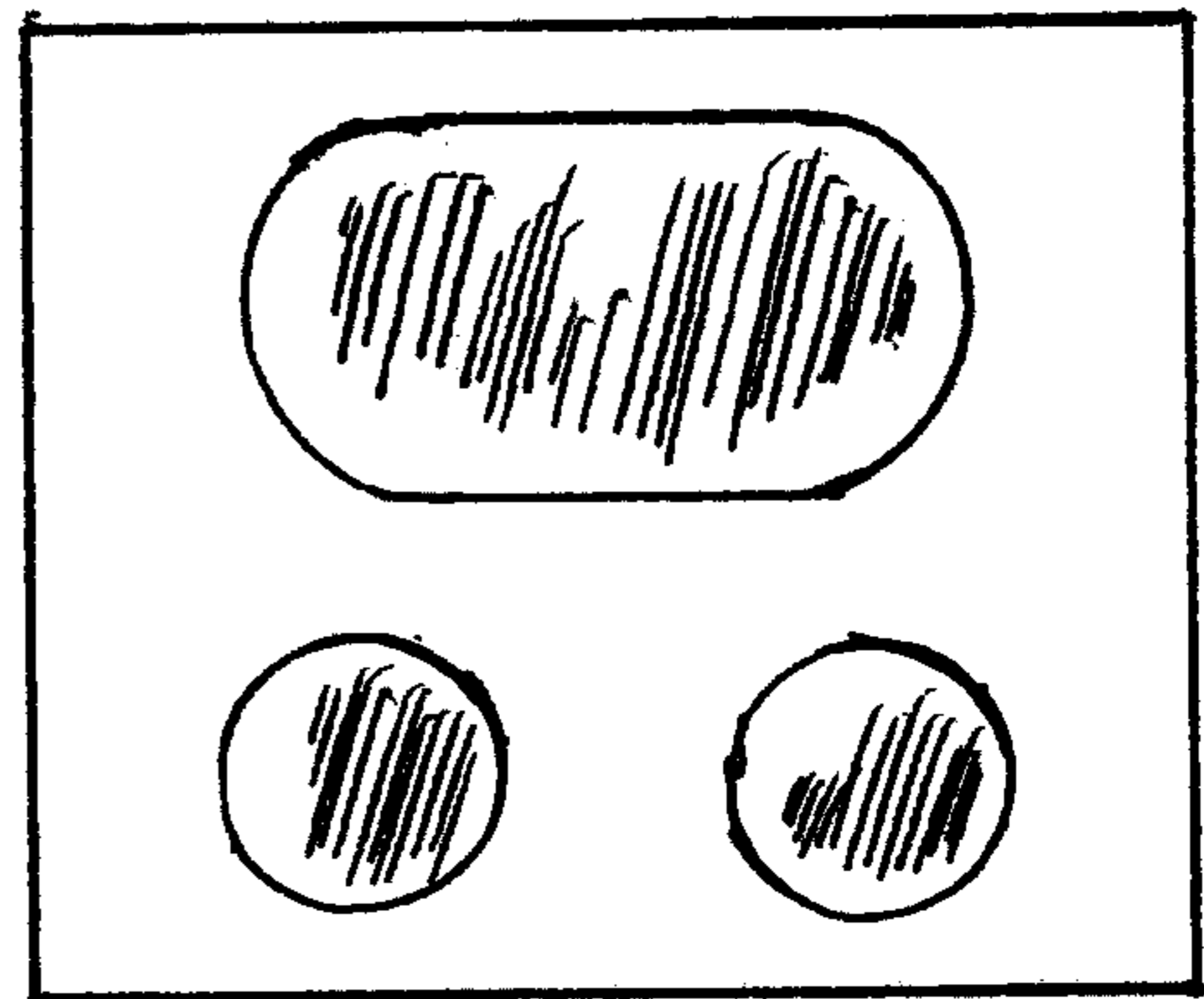

FIG. 2

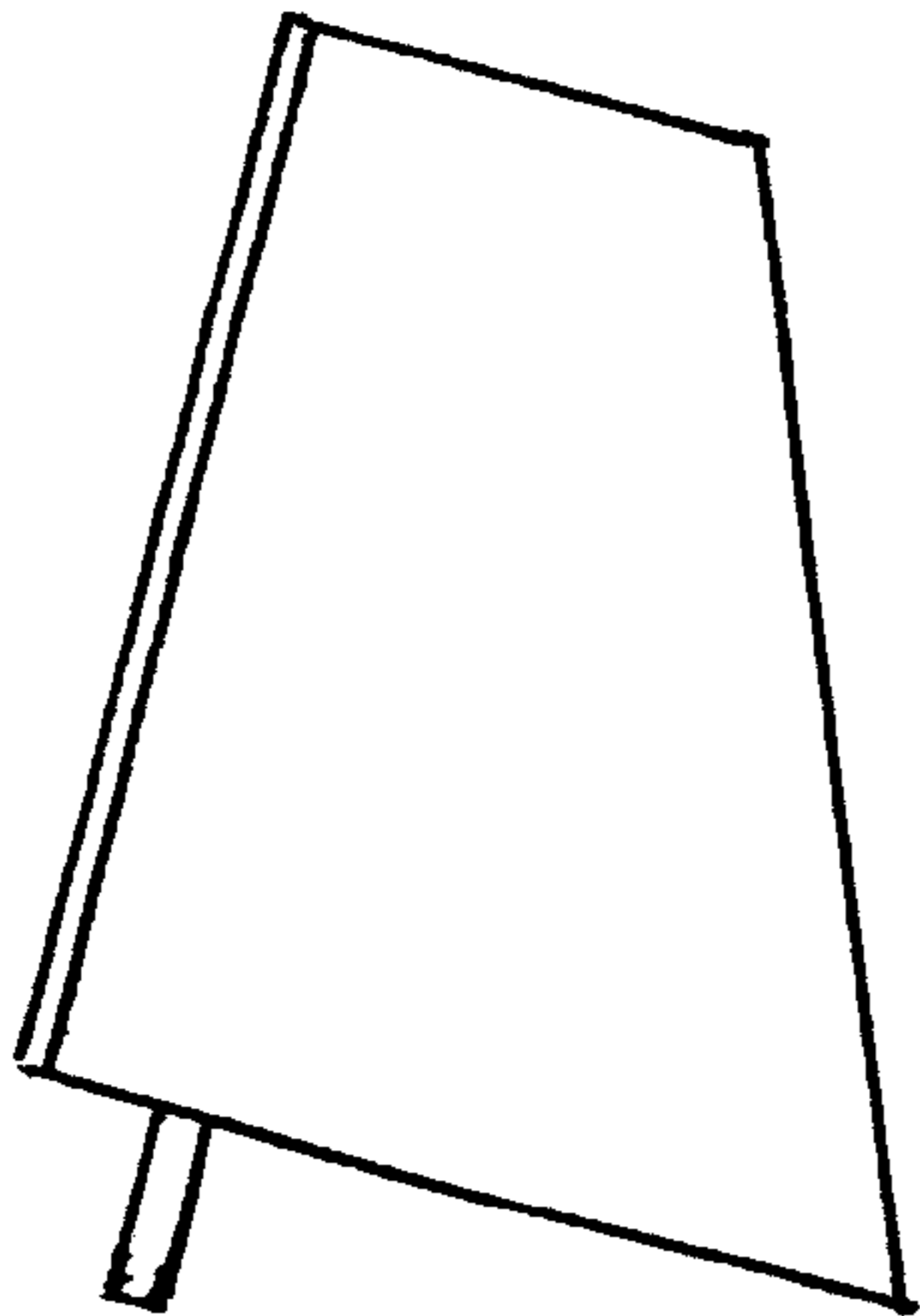

FIG. 3

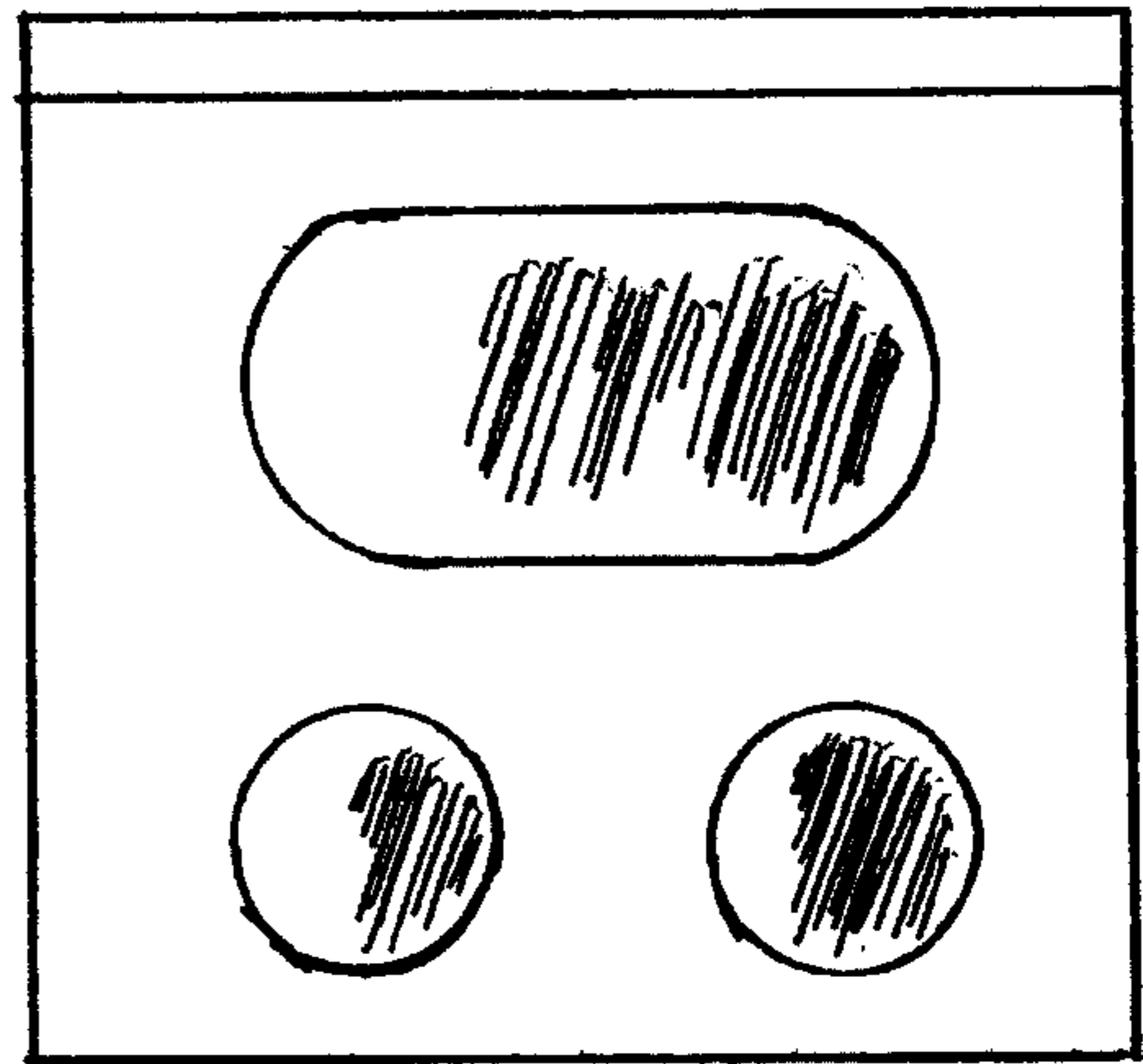

FIG. 4

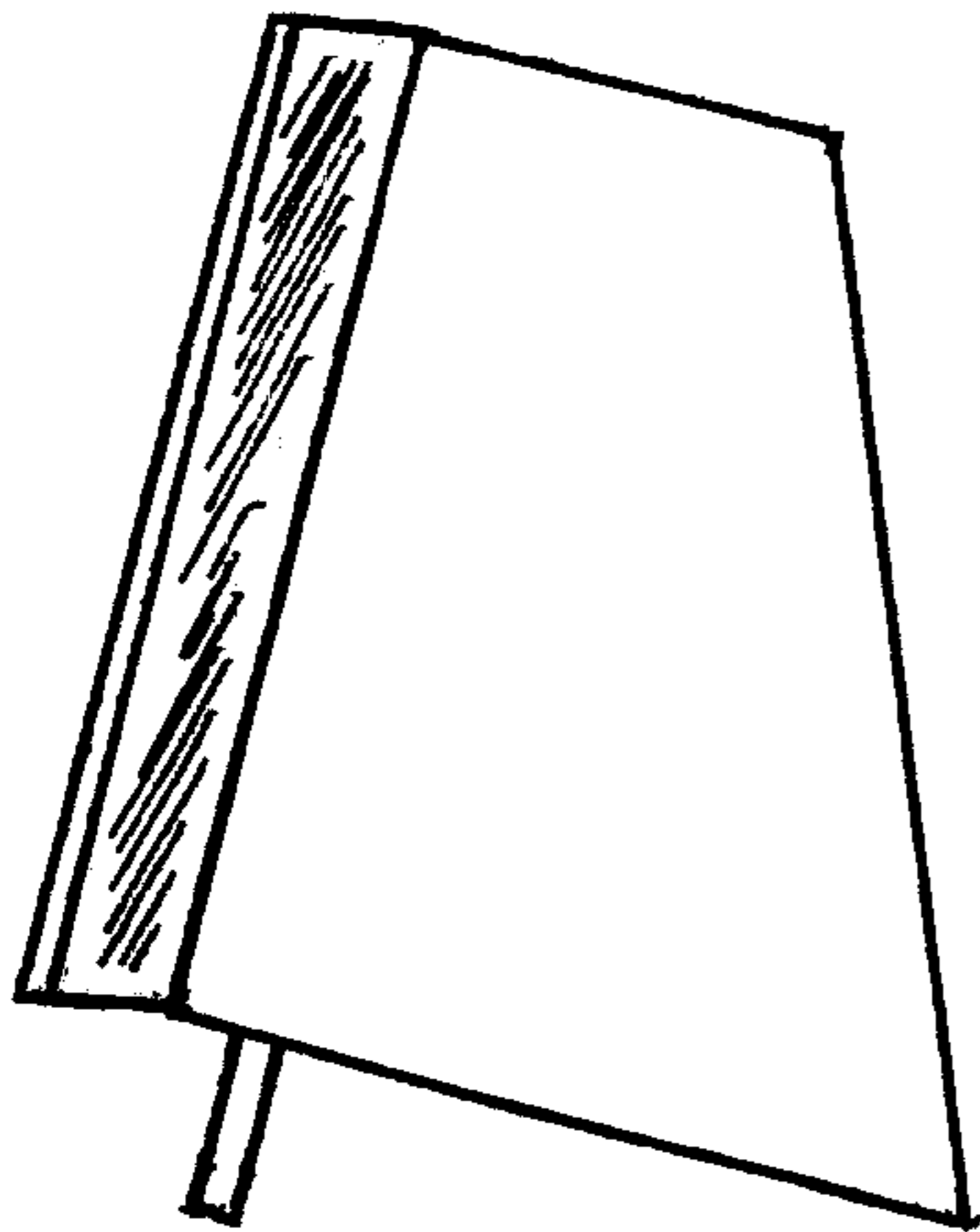

FIG. 5

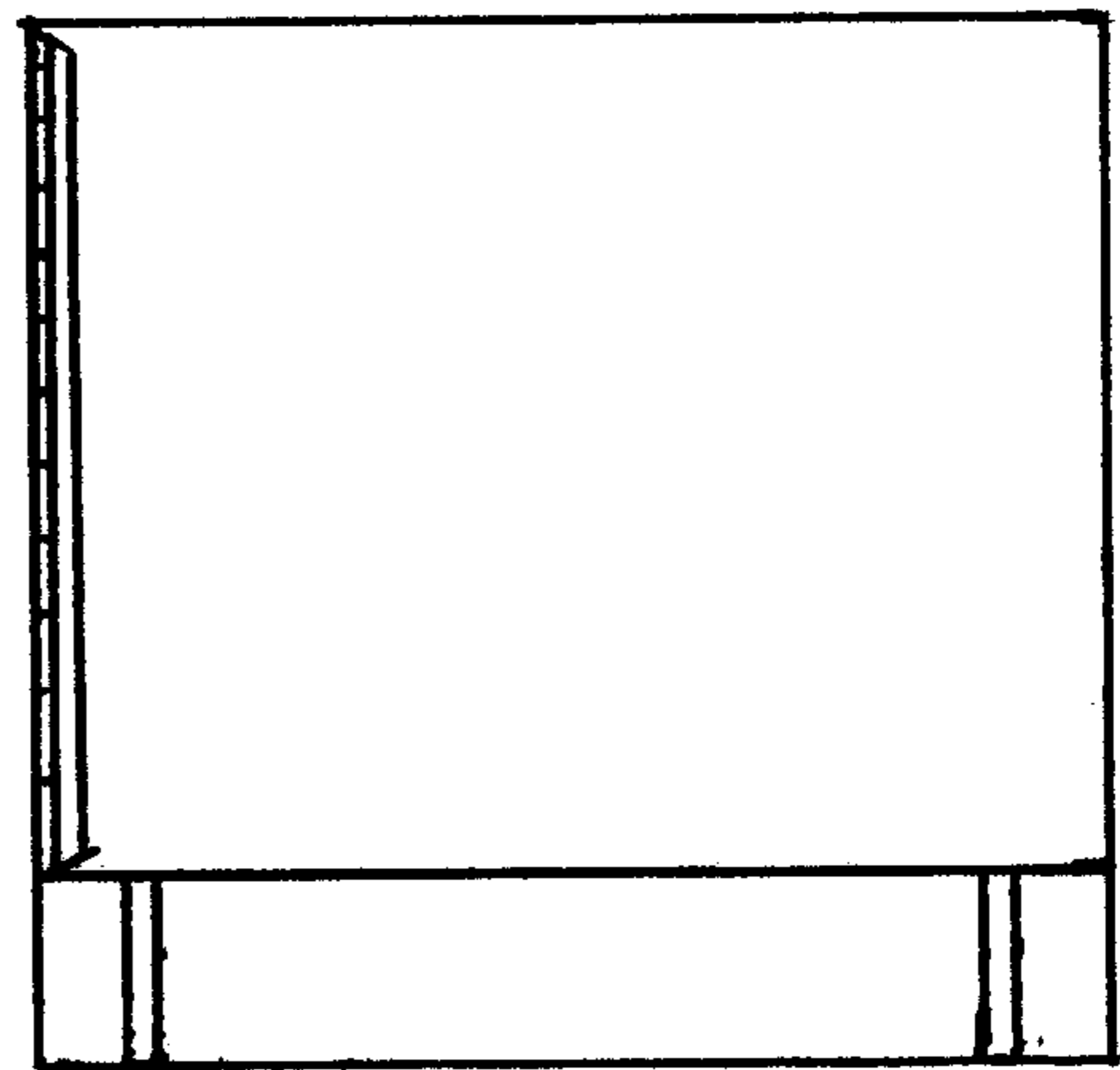

FIG. 6

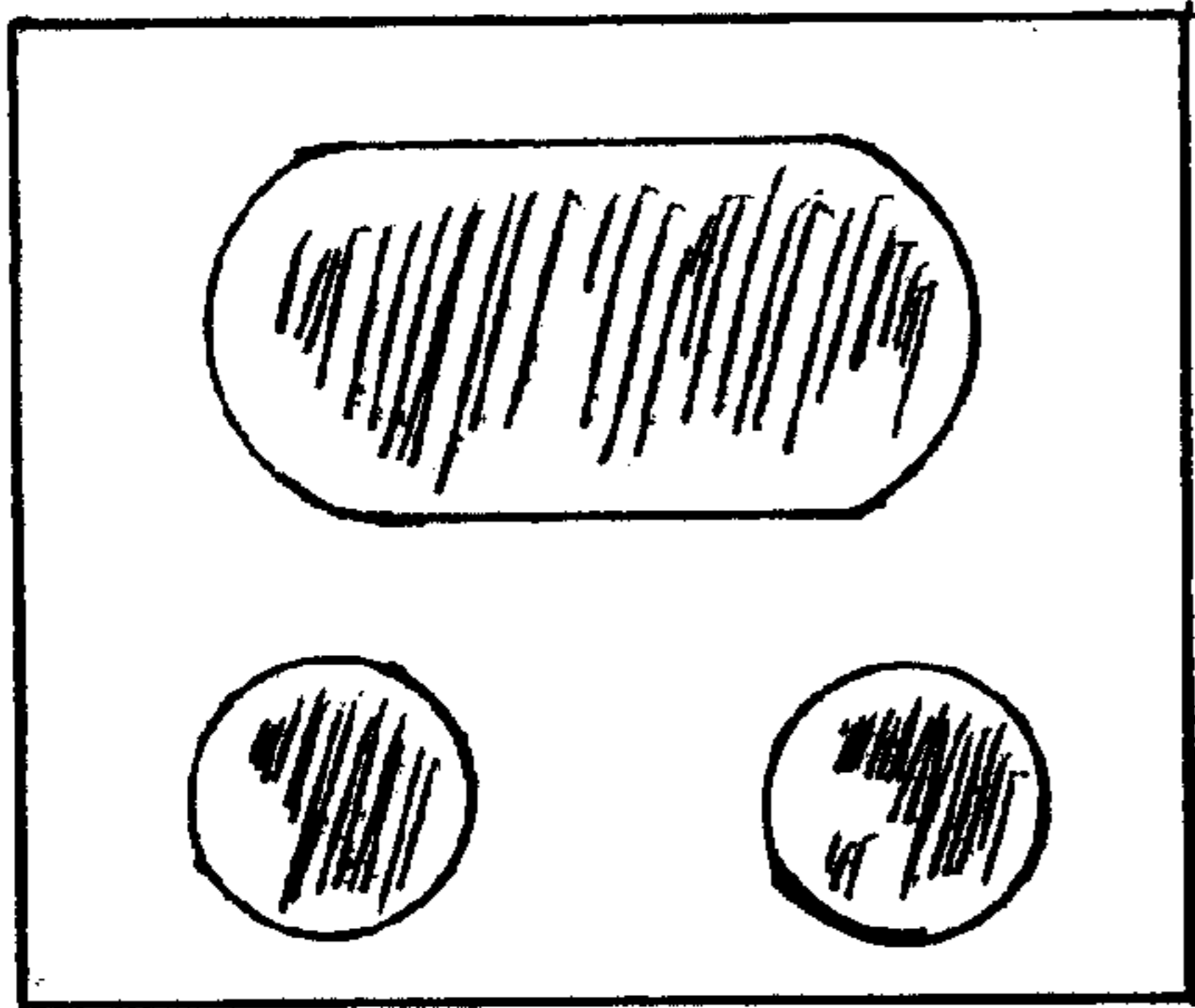

FIG. 7

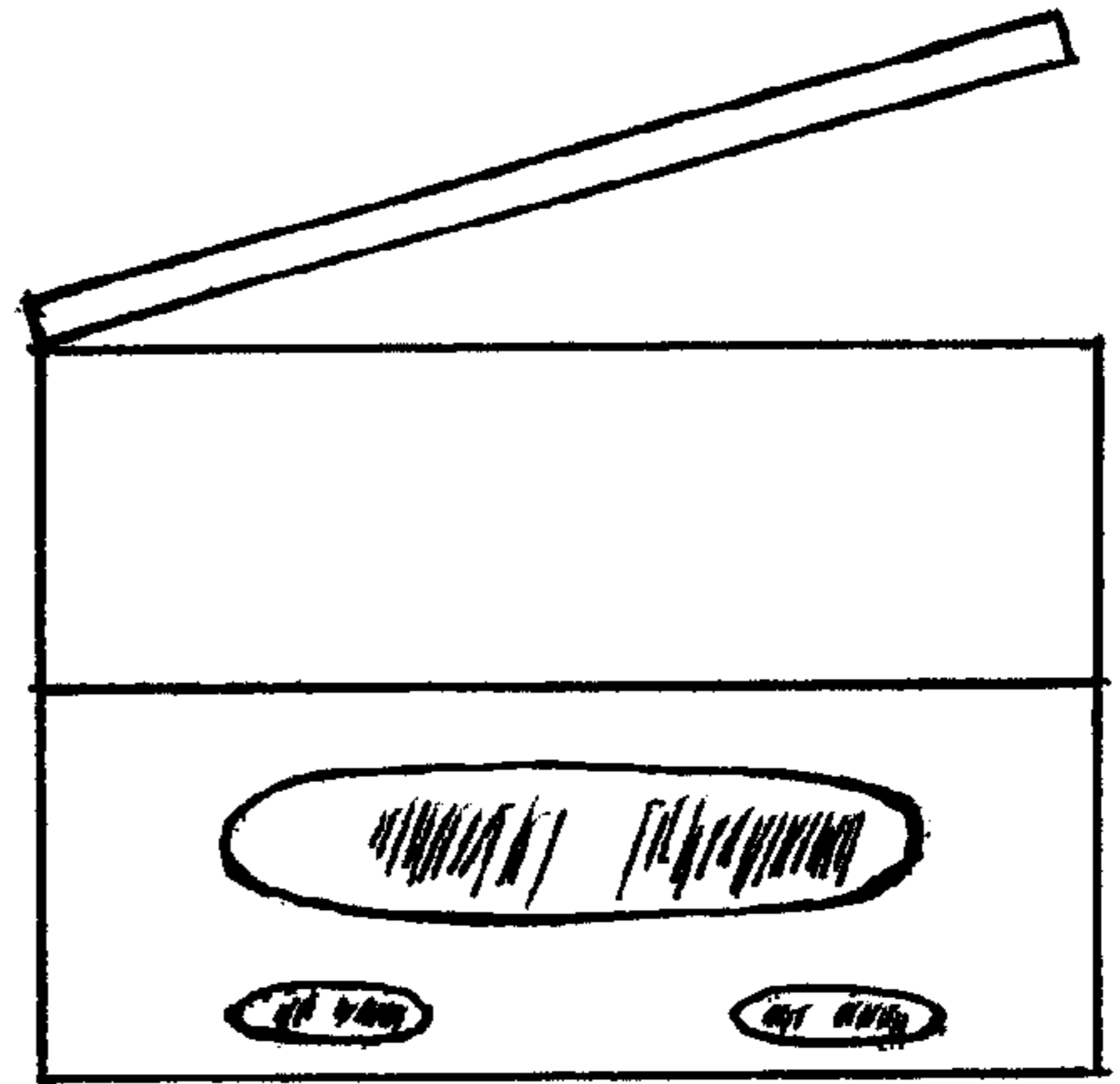

FIG. 8

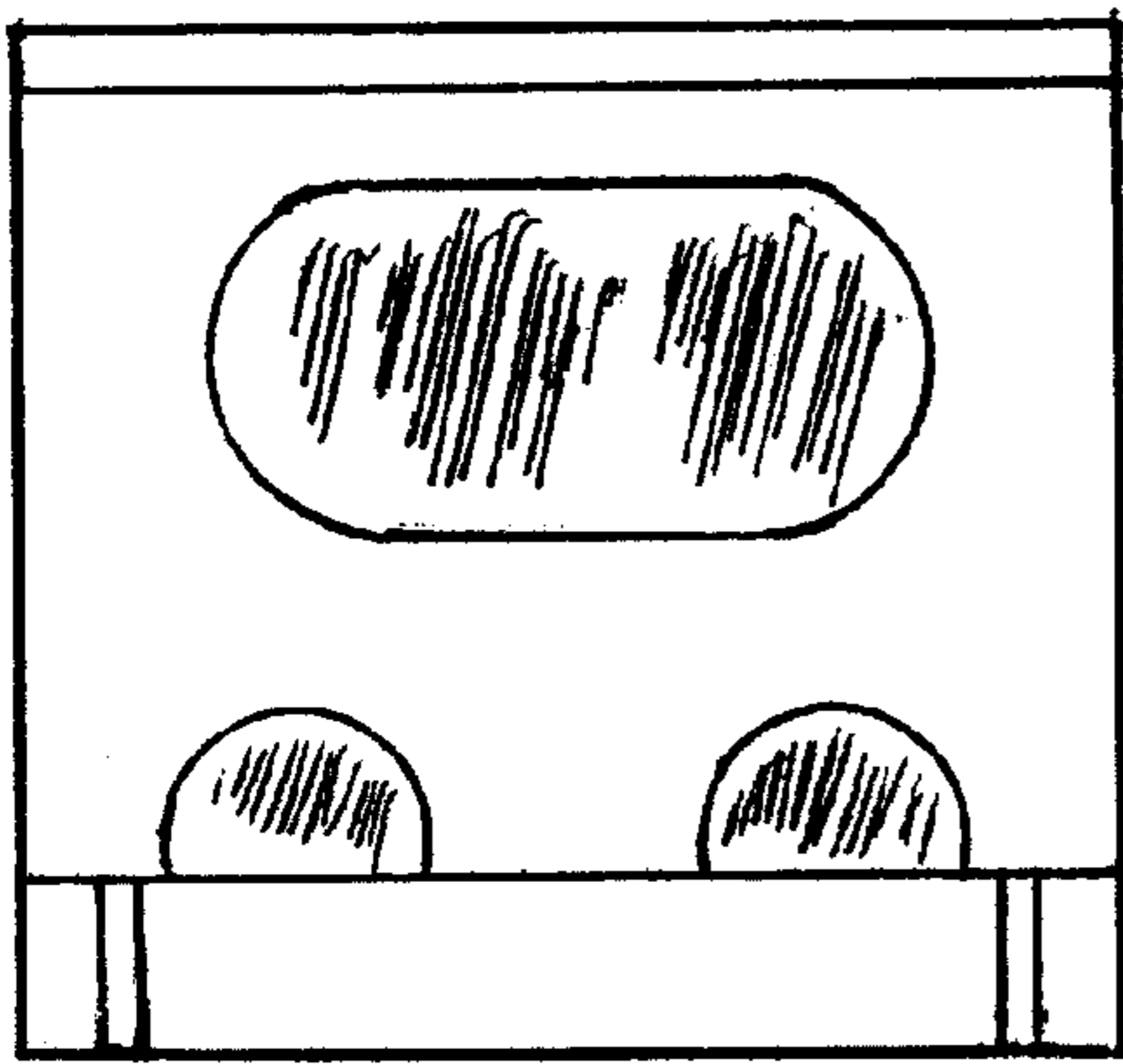

FIG. 9

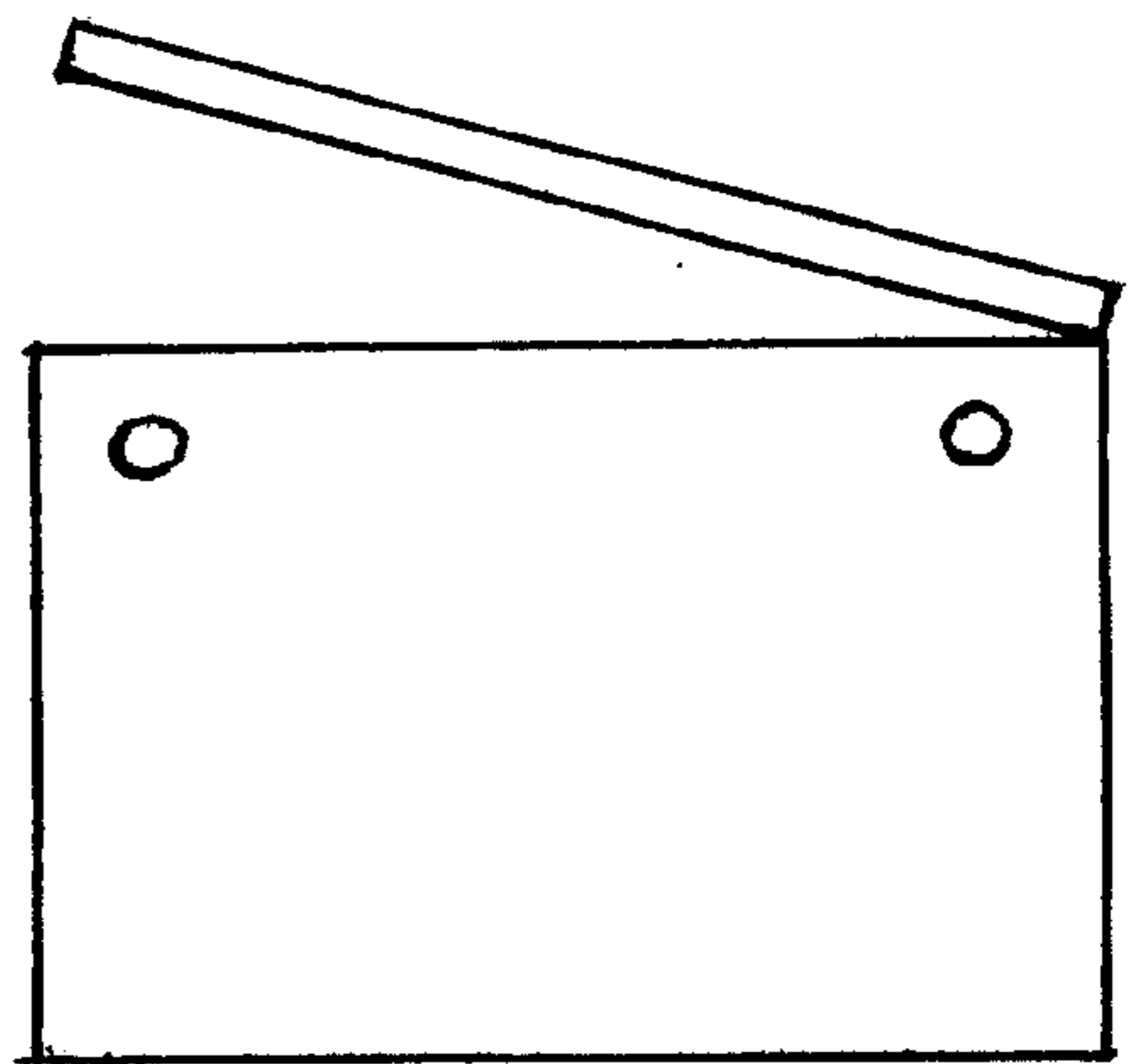

FIG. 10

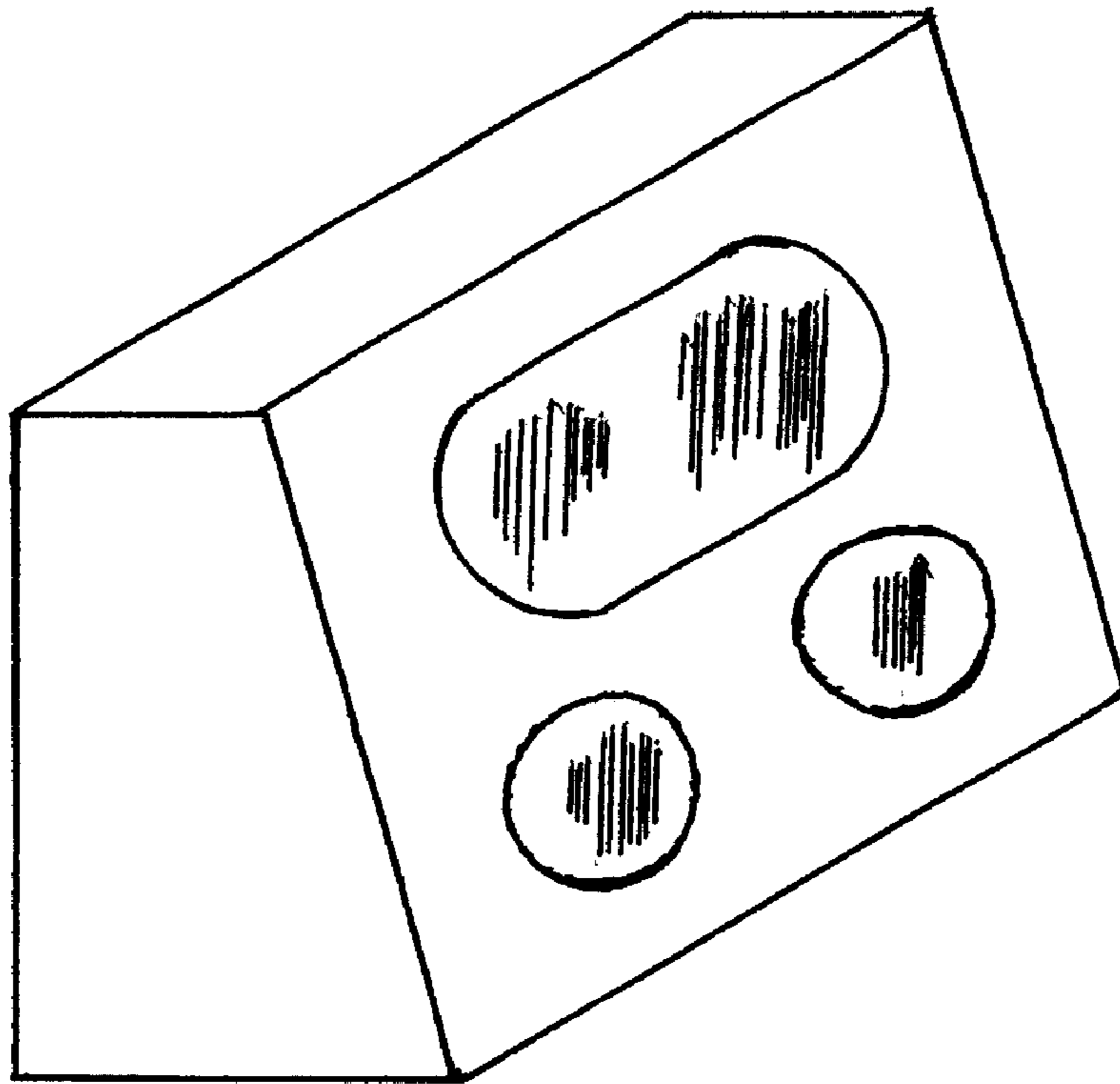

FIG. 11

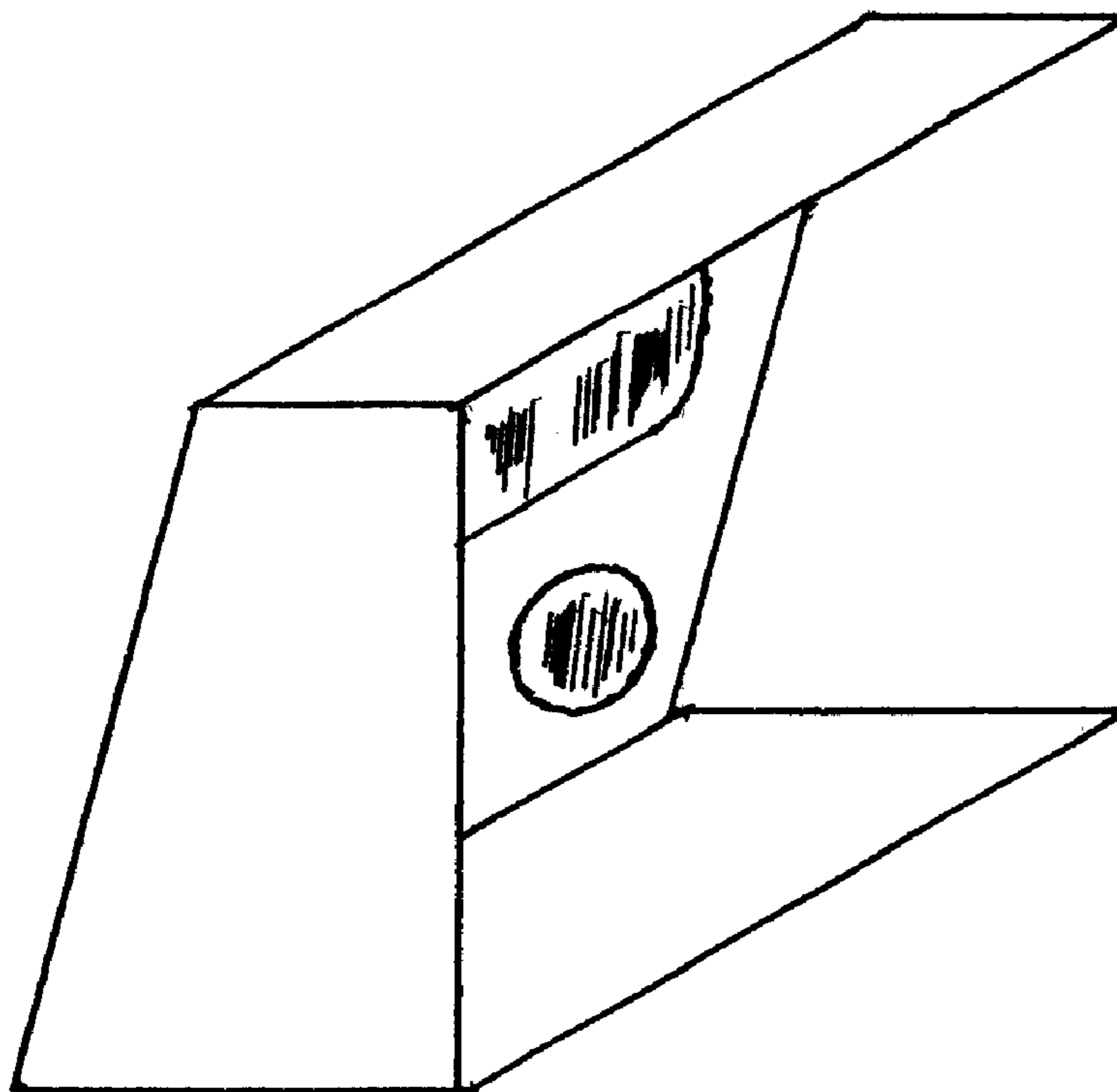

FIG. 12