



US00D473896S

(12) **United States Design Patent**
Yan

(10) **Patent No.:** **US D473,896 S**

(45) **Date of Patent:** **** Apr. 29, 2003**

(54) **REFILLING CLIP FOR INKJET CARTRIDGE**

(76) **Inventor:** **Yi-Tsung Yan, P.O. Box 96-405, Taipei 106 (TW)**

(**) **Term:** **14 Years**

(21) **Appl. No.:** **29/165,386**

(22) **Filed:** **Aug. 12, 2002**

(51) **LOC (7) Cl.** **18-02**

(52) **U.S. Cl.** **D18/56; 347/85**

(58) **Field of Search** **D18/56, 43; 347/86, 347/87, 85, 29, 32**

(56) **References Cited**

U.S. PATENT DOCUMENTS

5,627,573 A	*	5/1997	Fahy	347/32
5,838,352 A	*	11/1998	Martinez	347/87
5,845,682 A	*	12/1998	Hayao	347/86
5,883,653 A	*	3/1999	Sasaki	347/86
6,024,442 A	*	2/2000	Sato et al.	347/85
6,027,209 A	*	2/2000	Menendez et al.	347/85
D422,632 S	*	4/2000	Chung et al.	D18/56
6,053,605 A	*	4/2000	Sasaki	347/85
D425,111 S	*	5/2000	Inoue et al.	D18/56
D430,600 S	*	9/2000	Murcia et al.	D18/56

6,116,722 A	*	9/2000	Sato et al.	347/85
6,116,724 A	*	9/2000	Bursese	347/85
6,179,401 B1	*	1/2001	Stephens, Jr. et al.	347/85
6,478,415 B2	*	11/2002	Barinaga et al.	347/85

* cited by examiner

Primary Examiner—Cathy Anne MacCormac

(57) **CLAIM**

The ornamental design for a refilling clip for inkjet cartridge, as shown and described.

DESCRIPTION

FIG. 1 is a perspective view of a refilling clip for inkjet cartridge showing my new design; FIG. 2 is a front elevational view; FIG. 3 is a rear elevational view; FIG. 4 is a left side elevational view; FIG. 5 is a right side elevational view; FIG. 6 is a top plan view; FIG. 7 is a bottom plan view; and, FIG. 8 is a side elevational view. The broken lines in FIG. 8 are for illustrative purposes only and form no part of the claimed design.

1 Claim, 4 Drawing Sheets

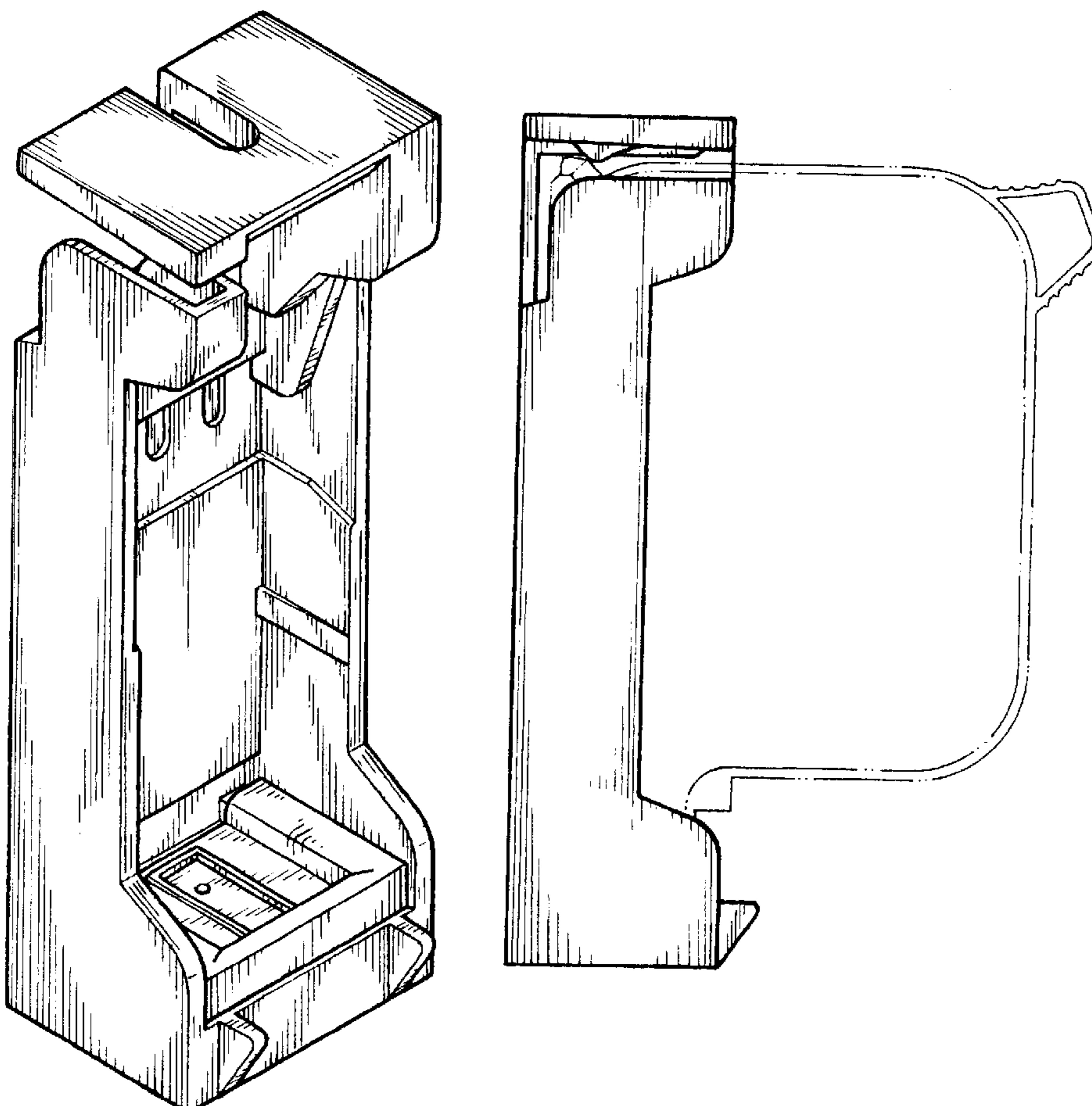

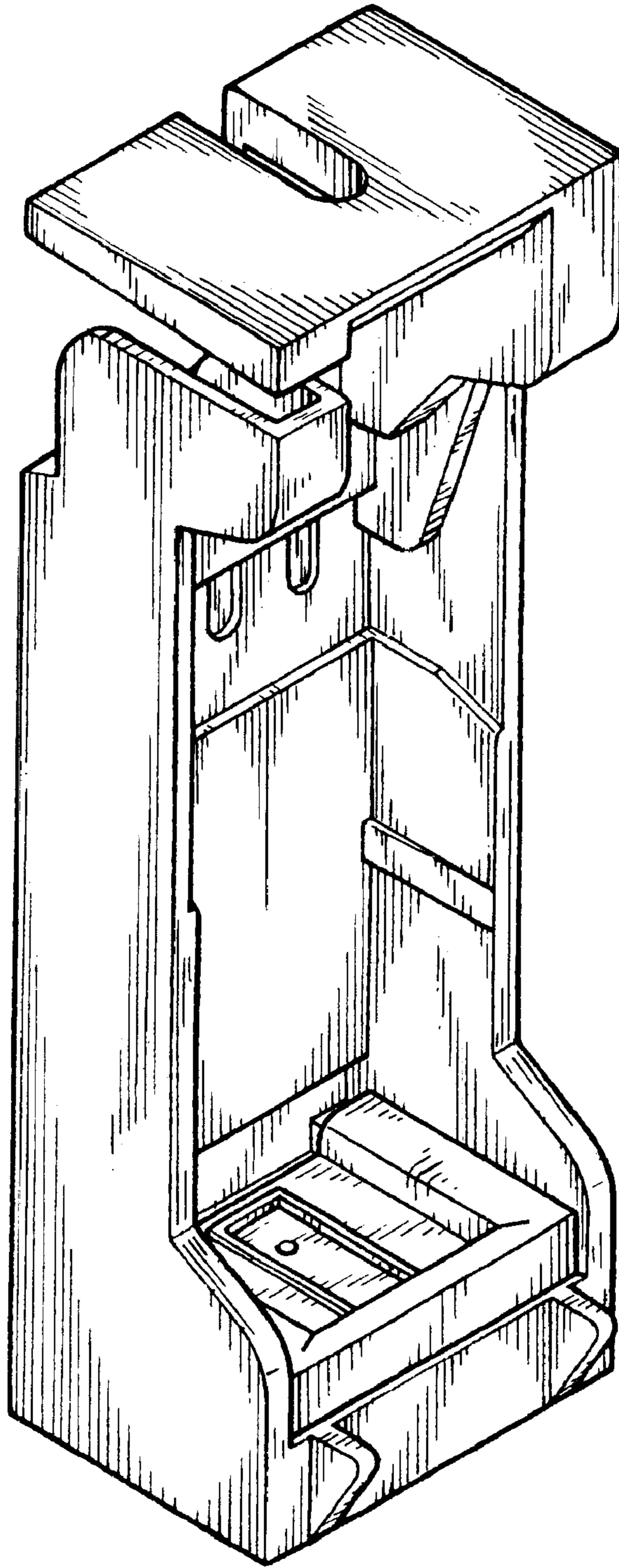

FIG. 1

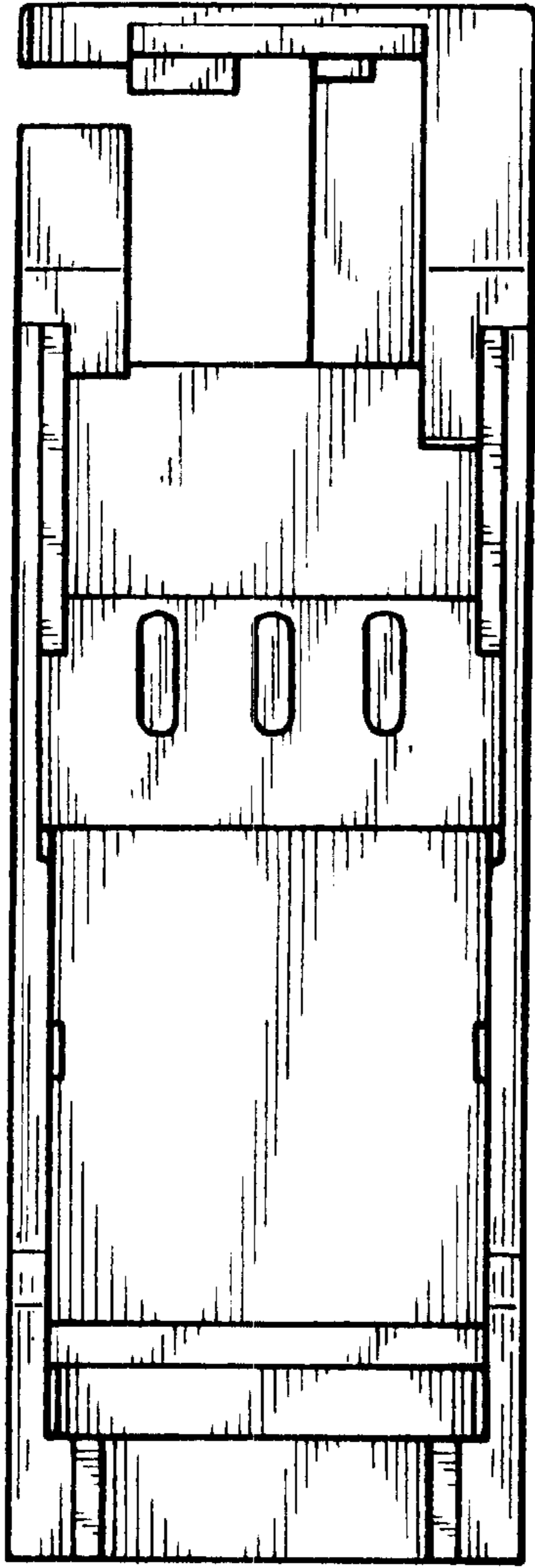

FIG. 2

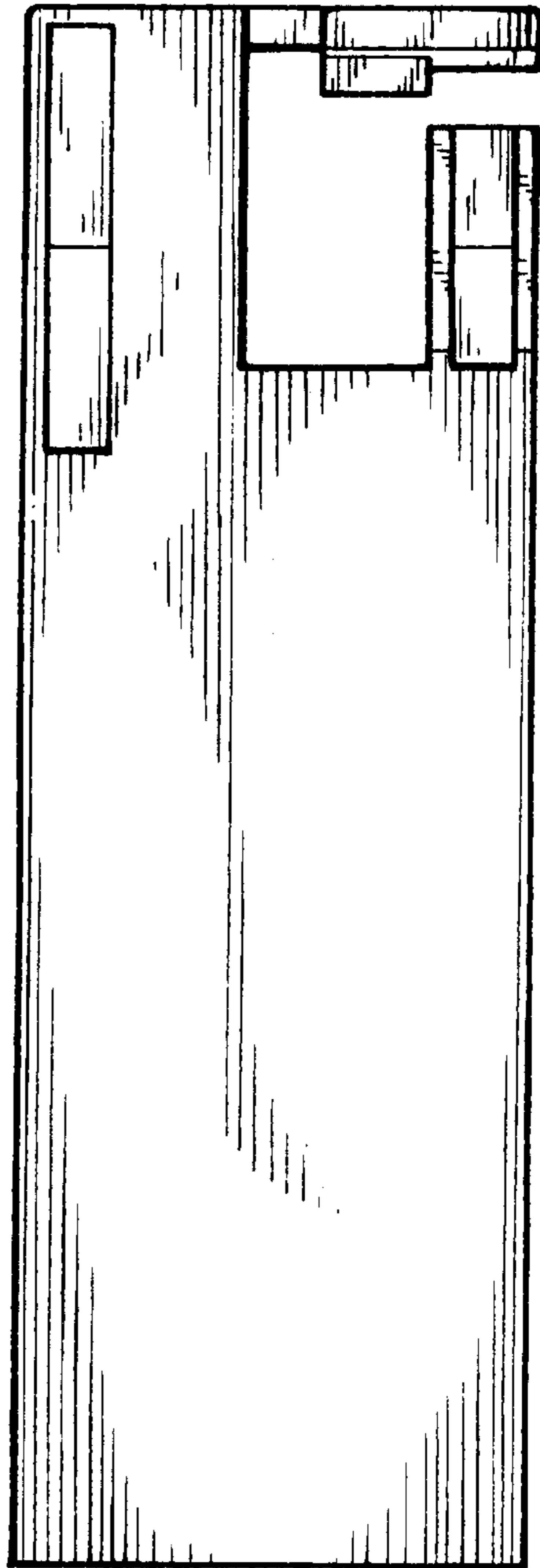

FIG. 3

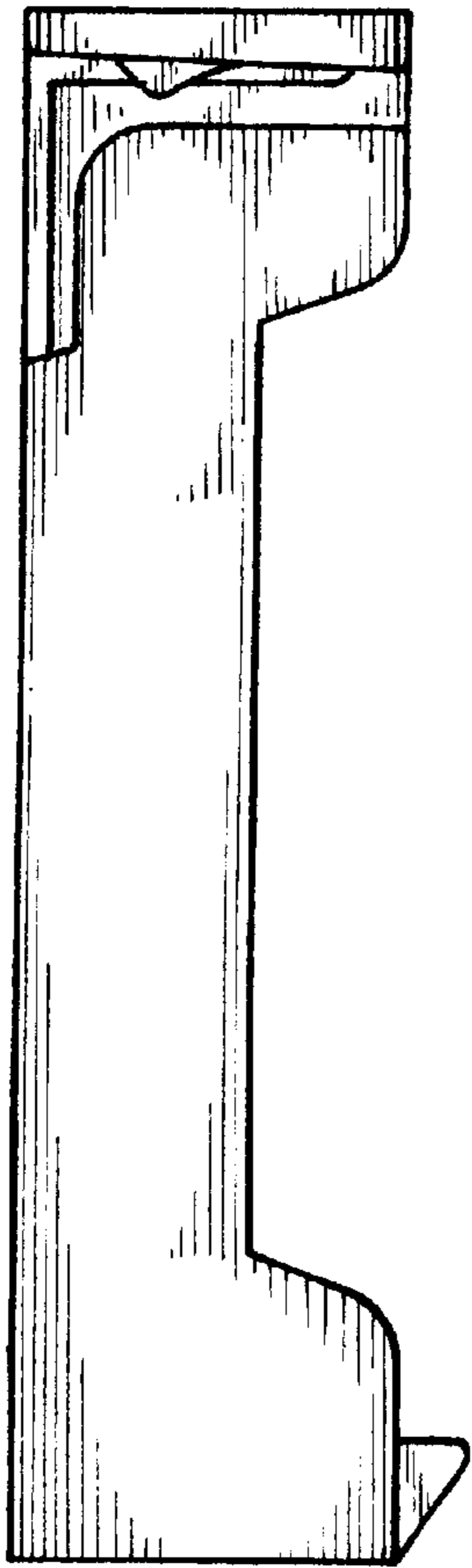

FIG. 4

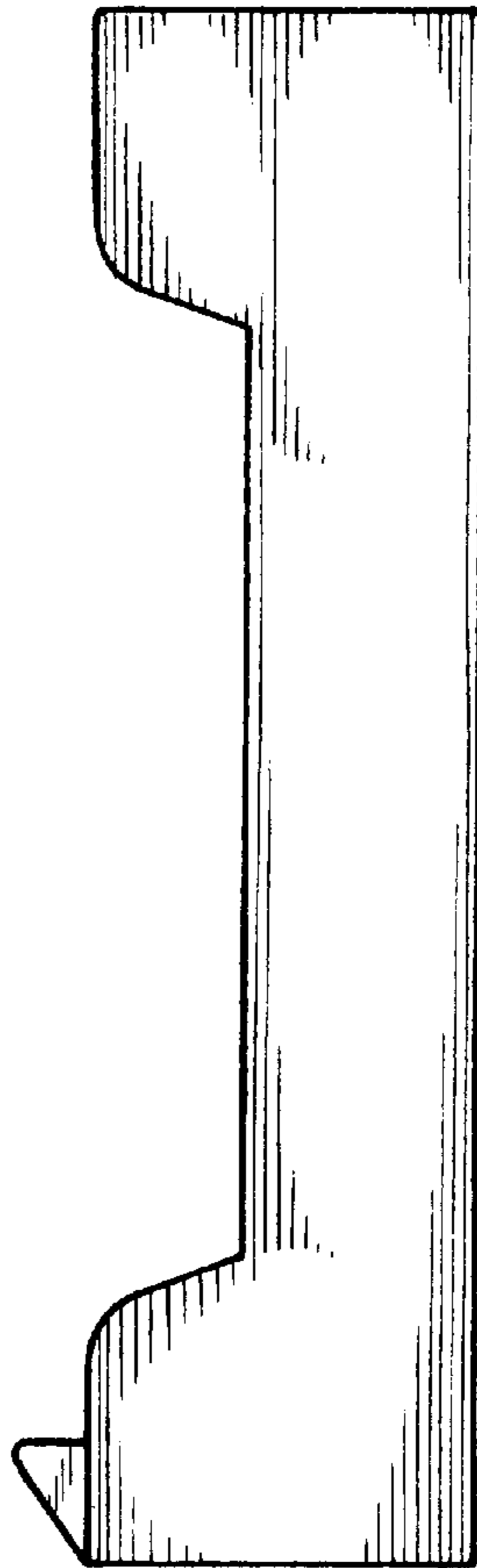

FIG. 5

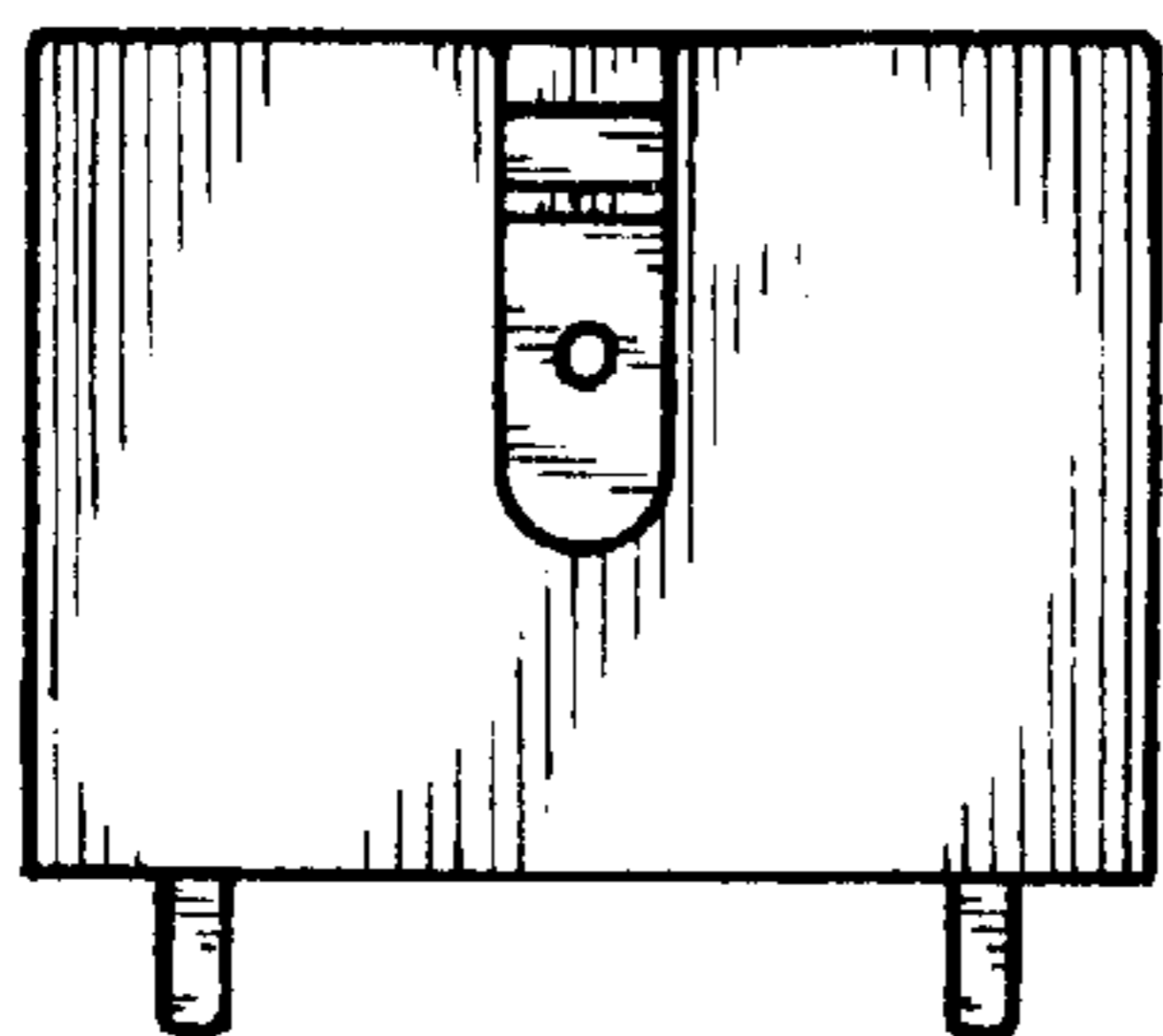

FIG. 6

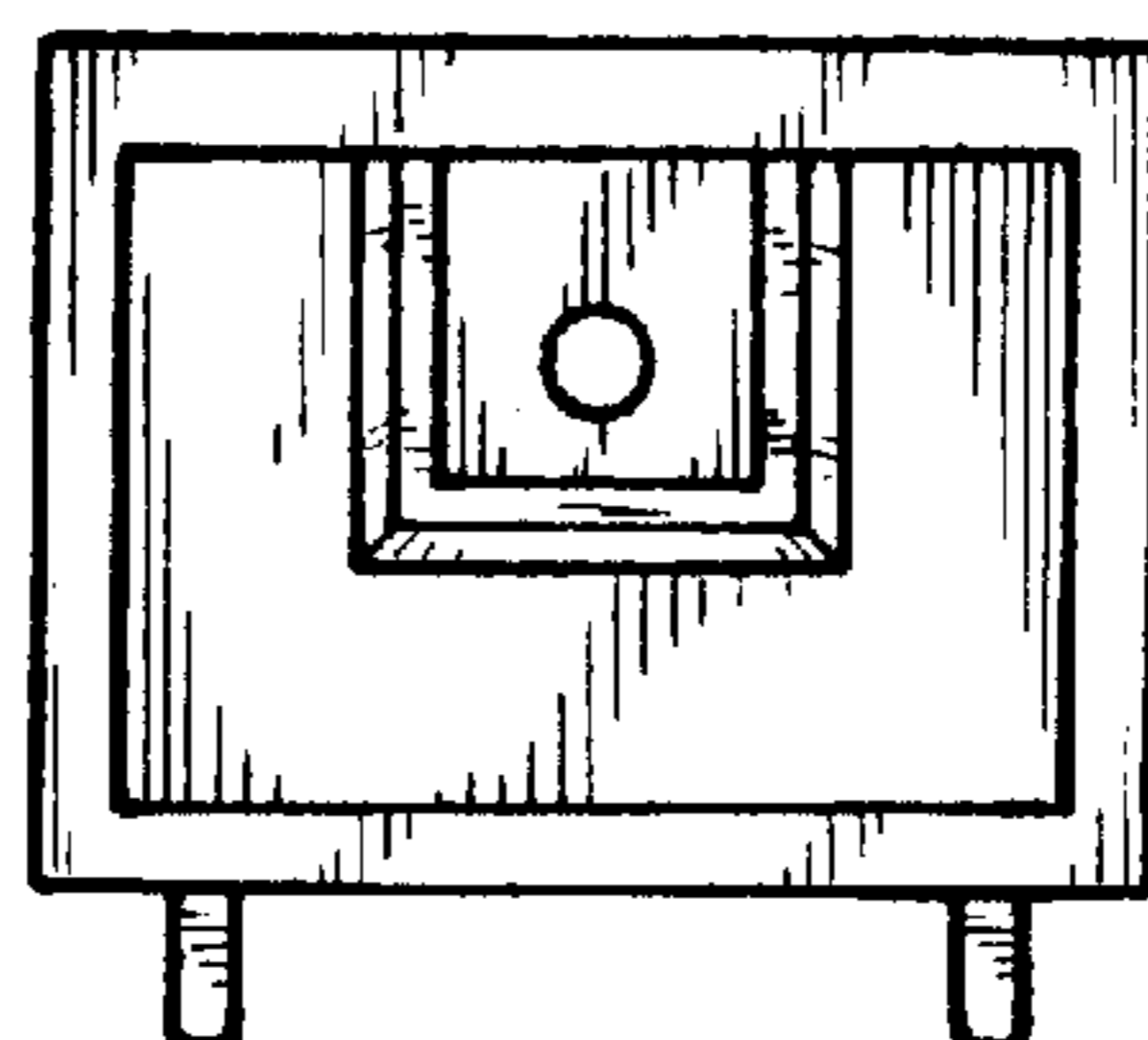

FIG. 7

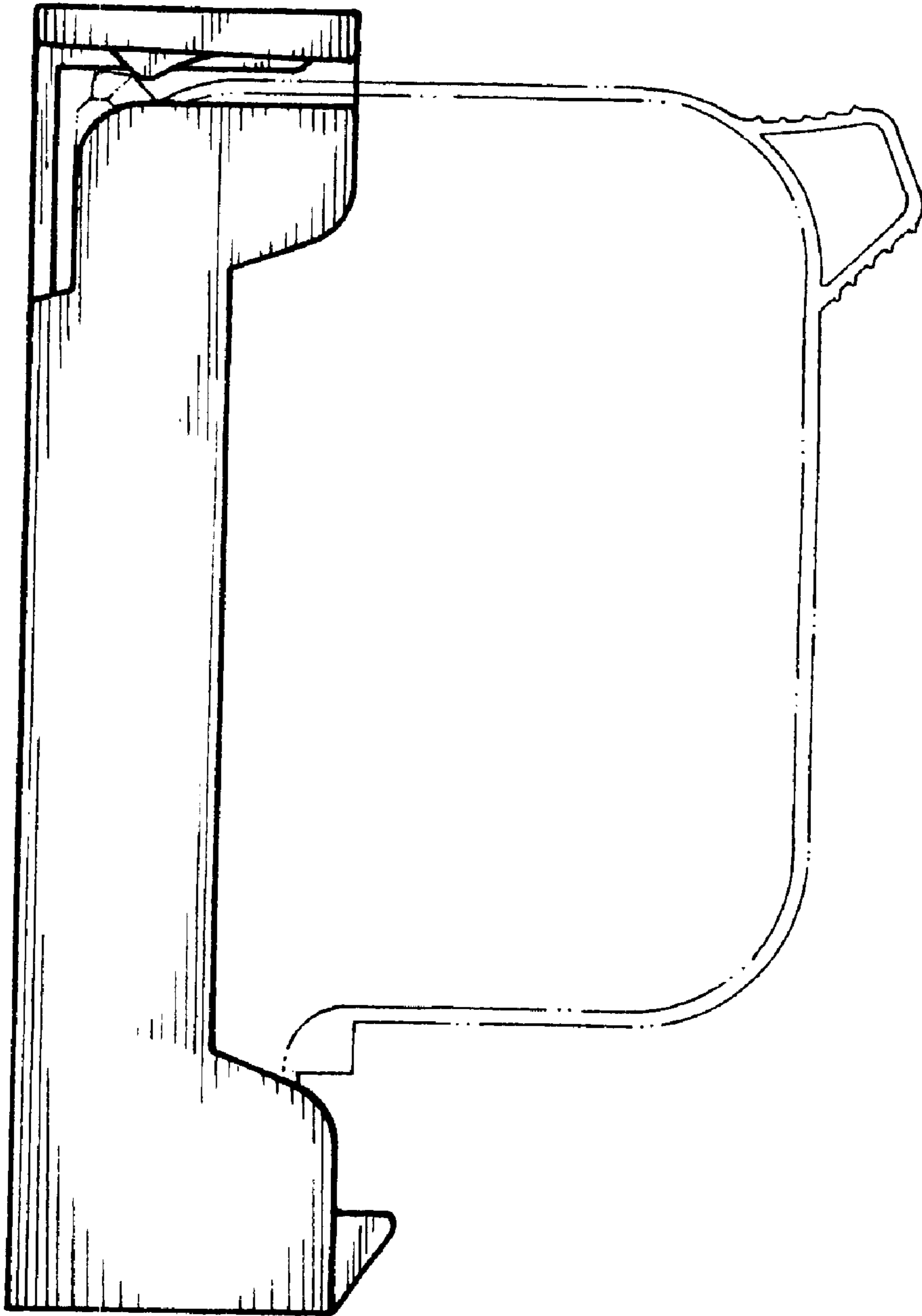

FIG. 8
