



US00D473797S

(12) **United States Design Patent**
Berliat

(10) **Patent No.:** **US D473,797 S**

(45) **Date of Patent:** **** Apr. 29, 2003**

(54) **WATCH**

(75) **Inventor:** **Jeannette Berliat, Zurich (CH)**

(73) **Assignee:** **Mondaine Watch Ltd, Zurich (CH)**

(**) **Term:** **14 Years**

(21) **Appl. No.:** **29/148,505**

(22) **Filed:** **Sep. 21, 2001**

(30) **Foreign Application Priority Data**

Mar. 21, 2001 (XH) DM/055 956

(51) **LOC (7) Cl.** **10-02**

(52) **U.S. Cl.** **D10/30**

(58) **Field of Search** D10/30-39, 122-132;
368/281-282, 276-277, 285

(56) **References Cited**

U.S. PATENT DOCUMENTS

1,996,276 A * 2/1935 Cowen D10/32 X

D420,293 S * 2/2000 Parmigiani D10/30
D441,665 S * 5/2001 Giardiello D10/32
D452,173 S * 12/2001 Giardiello D10/32
D452,657 S * 1/2002 Hegi D10/32

* cited by examiner

Primary Examiner—Nelson C. Holtje

(74) *Attorney, Agent, or Firm*—Bugnion S.A.; John Moeteli

(57) **CLAIM**

The ornamental design for watch, as shown and described.

DESCRIPTION

FIG. 1 is a front side view of watch, my new design;
FIG. 2 is a back side view thereof;
FIG. 3 is a right side view thereof;
FIG. 4 is a left side view thereof;
FIG. 5 is a top side view thereof; and,
FIG. 6 is a bottom side view thereof.

1 Claim, 1 Drawing Sheet

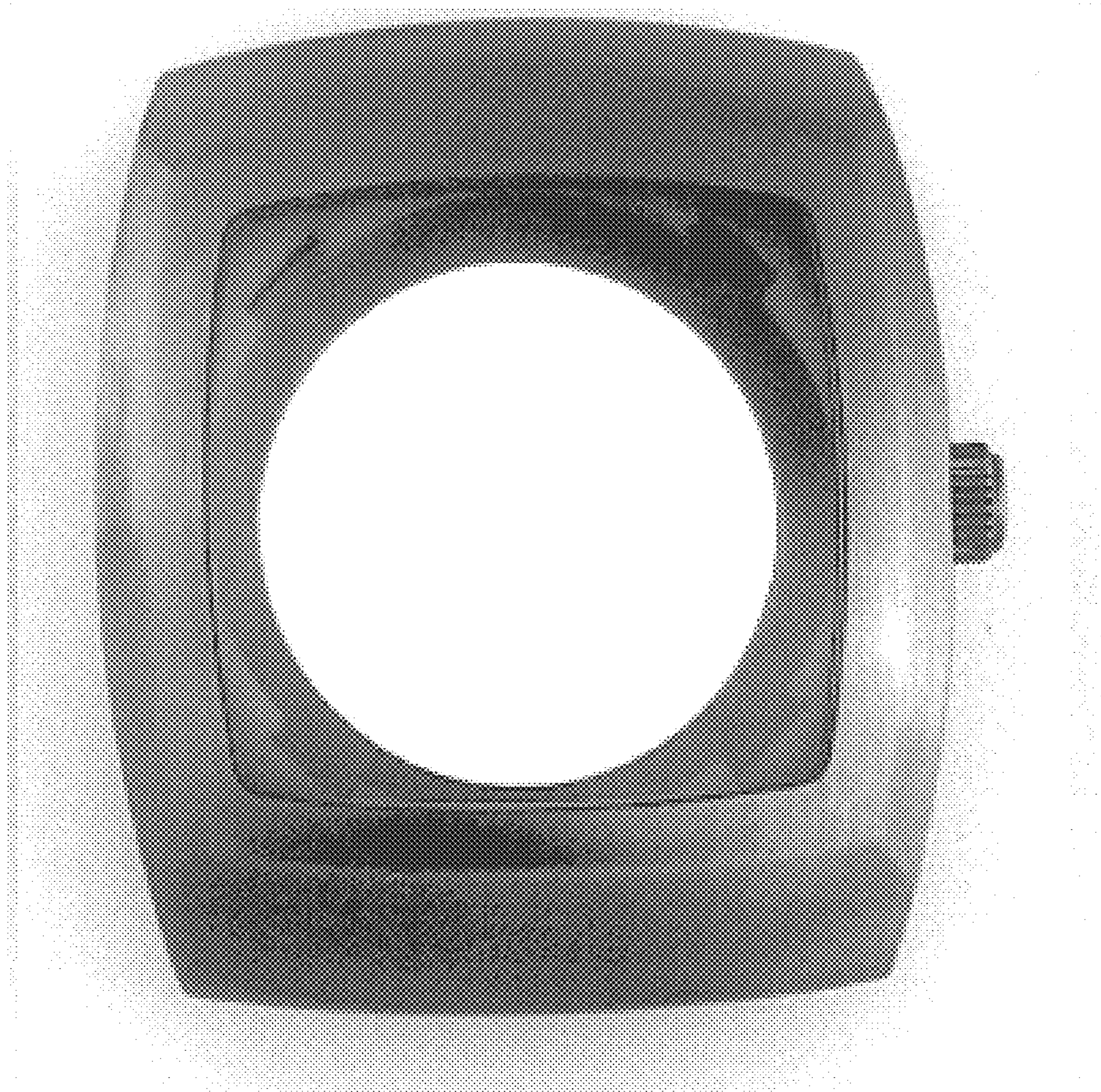

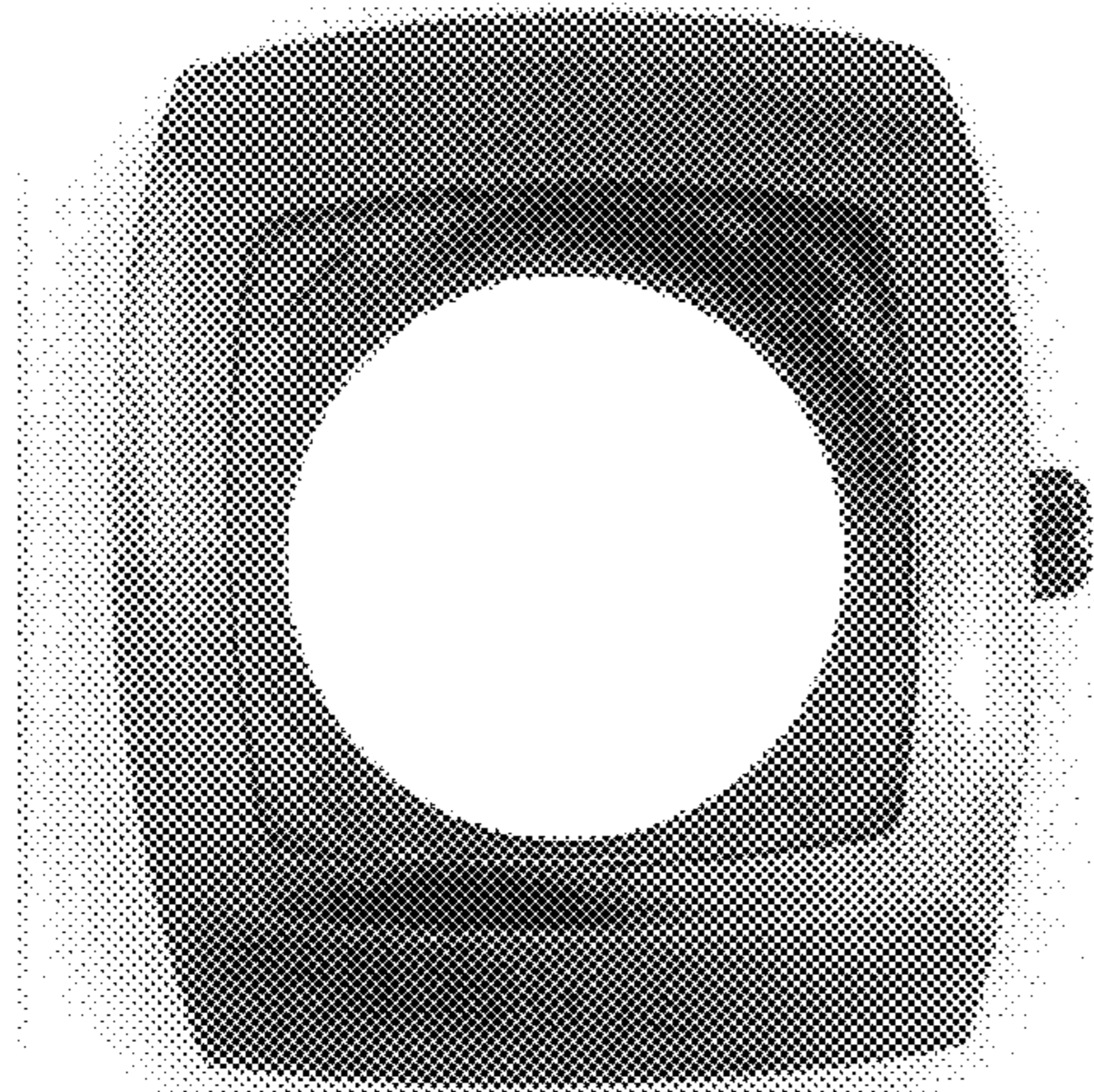

FIG. 1

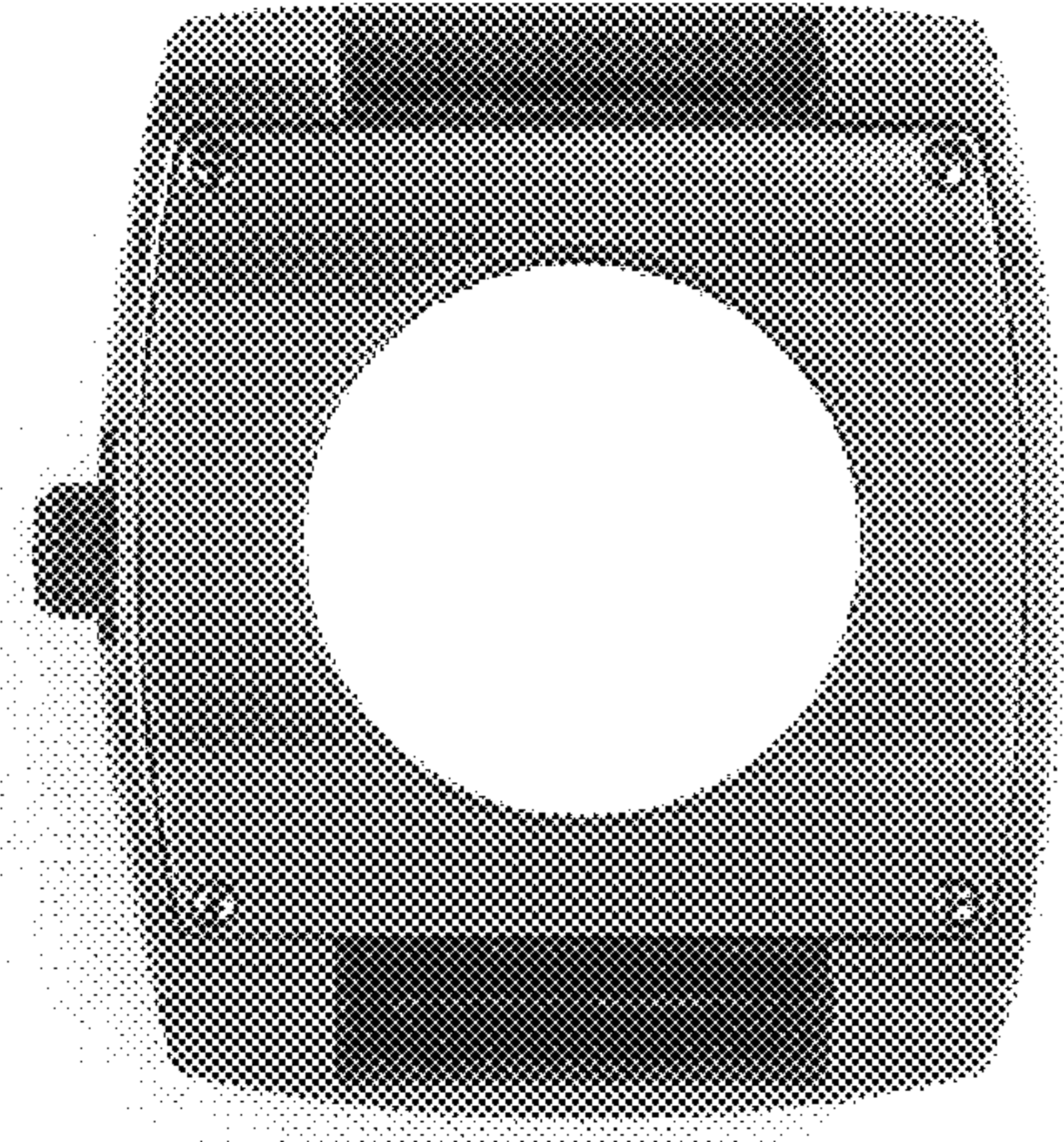

FIG. 2

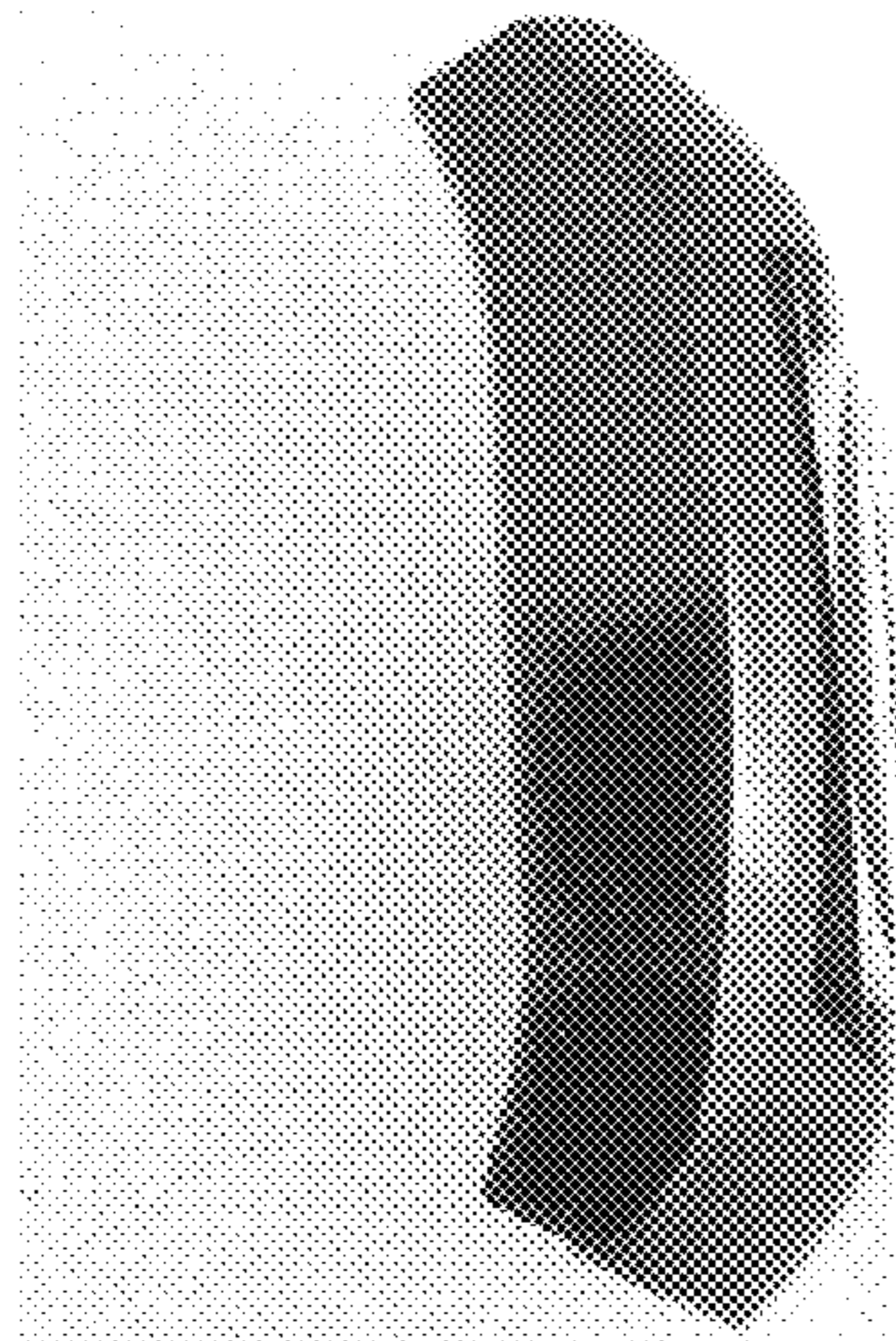

FIG. 3

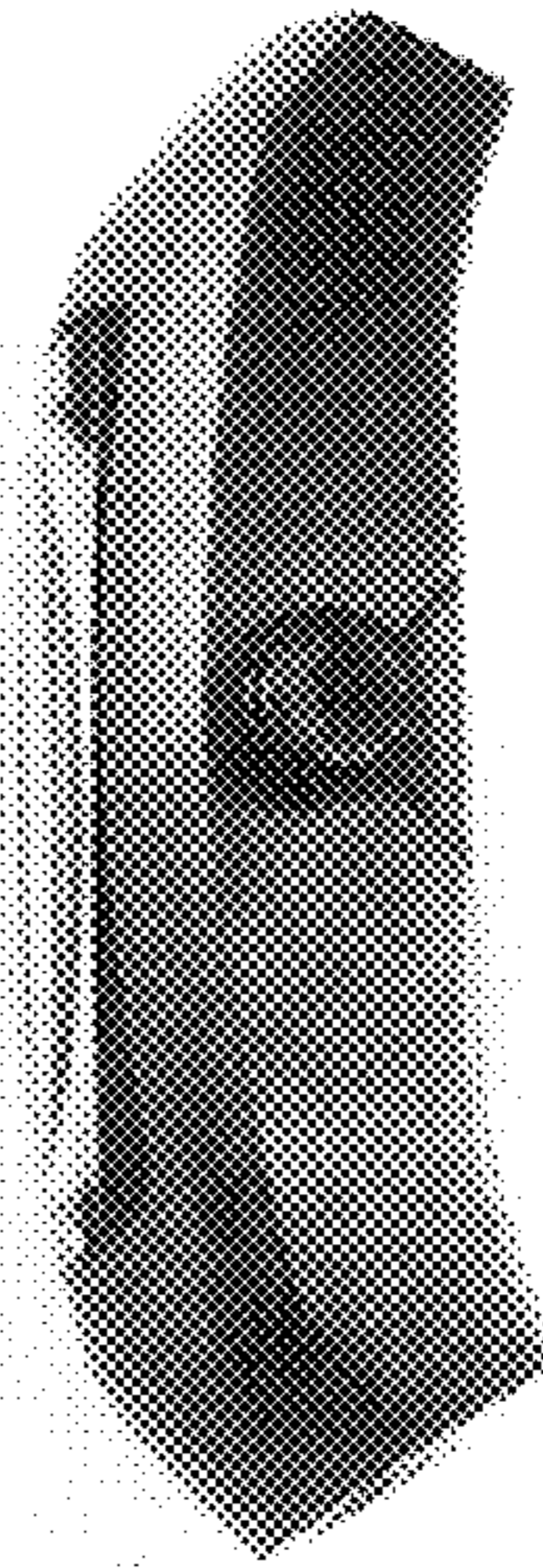

FIG. 4

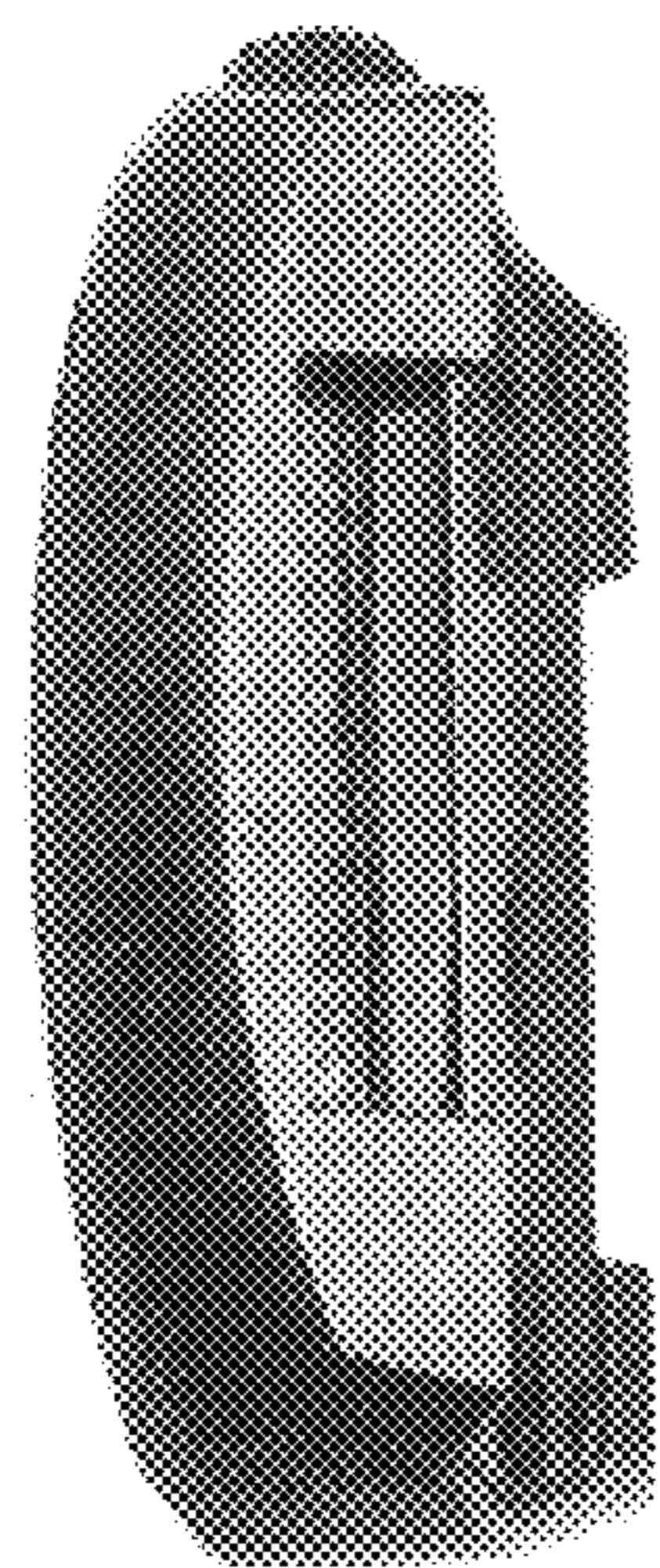

FIG. 5

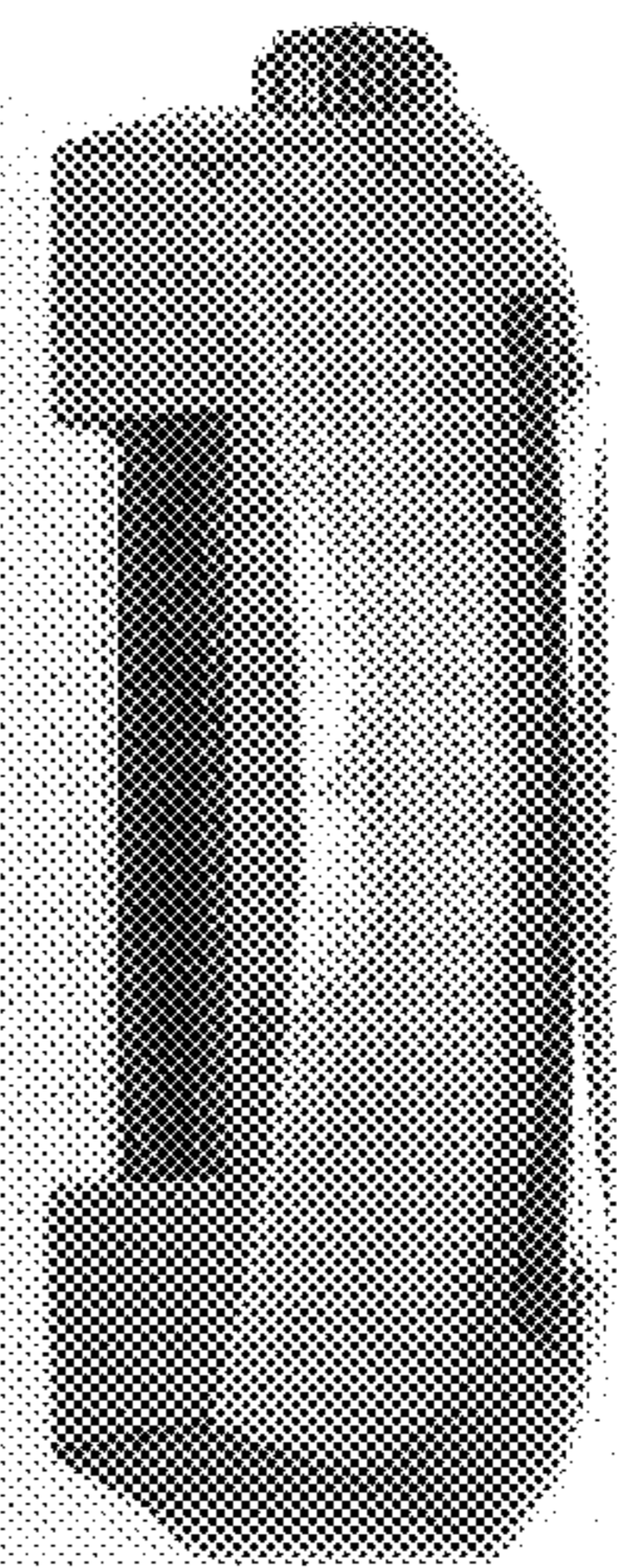

FIG. 6