



US00D473740S

(12) **United States Design Patent**
Ruhotas et al.

(10) **Patent No.:** **US D473,740 S**

(45) **Date of Patent:** **** Apr. 29, 2003**

(54) **DISPENSER**

OTHER PUBLICATIONS

(75) Inventors: **Christine Andrea Ruhotas**, Bexley (AU); **John McDevitt**, New Hope, PA (US); **Stephanie Rachel Watson**, Mosman (AU)

English translation to claims 1–13 of CN1064321 (2001).

Primary Examiner—Brian N. Vinson

(73) Assignee: **Johnson & Johnson Consumer Companies, Inc.**, Skillman, NJ (US)

(57) **CLAIM**

The ornamental design for a dispenser, as shown and described.

(**) Term: **14 Years**

DESCRIPTION

(21) Appl. No.: **29/137,755**

(22) Filed: **Feb. 27, 2001**

Related U.S. Application Data

(62) Division of application No. 29/120,997, filed on Mar. 30, 2000, now Pat. No. Des. 443,450.

(51) **LOC (7) Cl.** **20-02**

(52) **U.S. Cl.** **D6/515**

(58) **Field of Search** D6/515–522, 523;
D9/549; D3/273, 294, 301; 206/389, 409;
221/26, 33, 45, 282, 284

FIG. 1 is a perspective view wherein the broken lines are for environmental purposes and do not form a part of the claimed design;

FIG. 2 is a top plan view thereof;

FIG. 3 is a front elevational view thereof;

FIG. 4 is a side elevational view thereof, the opposite side being a mirror image;

FIG. 5 is a rear elevational view thereof;

FIG. 6 is a bottom plan view thereof;

FIG. 7 is a perspective view of another embodiment of our design wherein the broken lines are for environmental purposes and do not form a part of the claimed design;

FIG. 8 is a top plan view thereof;

FIG. 9 is a front elevational view thereof;

FIG. 10 a side elevational view thereof, the opposite side being a mirror image;

FIG. 11 is a rear elevational view thereof; and,

FIG. 12. is a bottom plan view thereof.

(56) **References Cited**

U.S. PATENT DOCUMENTS

2,826,230 A 3/1958 Conell et al.

(List continued on next page.)

FOREIGN PATENT DOCUMENTS

AU B-44145/85 1/1986

(List continued on next page.)

1 Claim, 12 Drawing Sheets

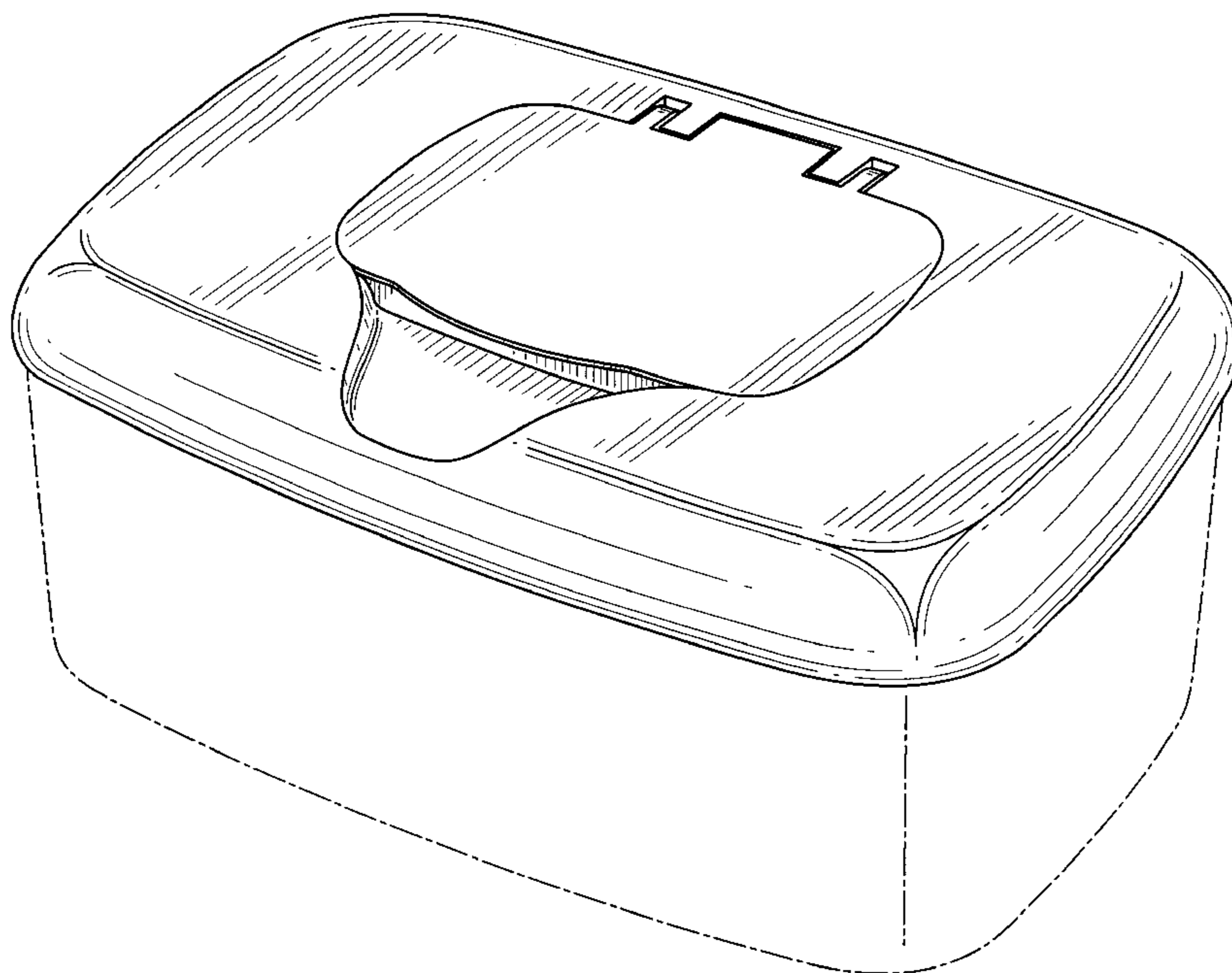

US D473,740 S

Page 2

			AU	S-124097	7/1995	
			AU	B-33167/95	5/1996	
			AU	A-45563/96	8/1996	
			AU	709893	1/1997	
			AU	S-134374	7/1998	
			AU	A-63497/98	10/1998	
			AU	S-136408	2/1999	
			AU	A-92373/98	3/1999	
			AU	94610/98	4/1999	
			AU	S-138516	10/1999	
			CN	92224107	9/1993	
			CN	94202213.0	5/1995	
			CN	94201333	8/1995	
			CN	2212384	11/1995	
			CN	94217891	11/1995	
			CN	95212028	2/1996	
3,780,908	A	12/1973	Fitzpatrick et al.	CN	1151962 A	6/1997
3,836,044	A	9/1974	Tilp et al.	CN	2327313 Y	7/1999
3,836,045	A	9/1974	Duhy et al.	CN	1064321	4/2001
3,862,703	A	1/1975	Dutcher	EP	0629560 B1	12/1994
3,994,417	A	11/1976	Boedecker	EP	0680888 B1	11/1995
4,289,262	A	9/1981	Finkelstein	EP	0738667 B1	10/1996
4,458,810	A	7/1984	Mahoney	EP	0748748 B1	12/1996
4,462,507	A	7/1984	Margulies	EP	233476	6/1977
4,513,877	A	4/1985	Taguchi et al.	ES	1033201	2/1996
4,526,291	A	7/1985	Margulies	ES	145004	3/1999
4,534,491	A	8/1985	Norton et al.	ES	145005	3/1999
4,535,912	A	8/1985	Bonk	GB	2077827	9/1999
4,678,099	A	7/1987	Matsui	GB	2077828	9/1999
4,735,317	A	4/1988	Sussman et al.	GB	2080861	9/1999
4,768,679	A	9/1988	Matsui	GB	2080862	9/1999
4,848,575	A	7/1989	Nakamura et al.	JP	60-161926	8/1985
4,863,064	A	9/1989	Dailey, III	JP	61-178	12/1986
4,877,154	A	10/1989	Matsui	JP	63-26553	2/1988
5,040,680	A	8/1991	Wilson et al.	JP	63-88965	4/1988
5,048,715	A	9/1991	Wolff	JP	2-10248	1/1990
5,050,737	A	9/1991	Joslyn et al.	JP	3-69656	3/1991
5,090,592	A	2/1992	Petterson et al.	JP	7-257617	10/1995
5,090,592	A	2/1992	Petterson et al.	JP	8-40451	2/1996
D332,193	S	1/1993	Petterson et al.	JP	08053151 A	2/1996
5,219,421	A	6/1993	Tipping	JP	8-72913	3/1996
5,344,037	A	9/1994	Favre	JP	8-133319	5/1996
5,415,320	A	5/1995	North et al.	JP	8217113	8/1996
5,501,348	A	3/1996	Takeuchi	JP	08244815 A	9/1996
5,516,001	A	5/1996	Muckenfuhs et al.	JP	08244819 A	9/1996
5,542,567	A	8/1996	Julius	JP	08253255 A	10/1996
5,542,568	A	8/1996	Julius	JP	8-318962	12/1996
5,560,514	A	10/1996	Frazier	JP	8-318963	12/1996
5,582,294	A	12/1996	Yamada	JP	09039996 A	2/1997
5,647,506	A	7/1997	Julius	JP	09066954 A	3/1997
5,699,912	A	12/1997	Ishikawa et al.	JP	09295657 A	11/1997
5,729,955	A	3/1998	Yamada	TW	34565	1/1987
5,884,804	A	3/1999	King	TW	157397	5/1991
5,908,138	A	6/1999	Vlahakis et al.	TW	263914	12/1995
5,908,246	A	6/1999	Arimura et al.	TW	120095	8/1996
5,938,013	A	8/1999	Palumbo et al.	TW	117693	11/1996
				TW	088068	7/1997
				TW	141560	12/1998
				TW	346915	12/1998
				WO	WO95/30593	11/1995
				WO	WO98/19934	5/1998
				WO	WO98/55372	12/1998
				WO	WO99/19227	4/1999

FOREIGN PATENT DOCUMENTS

AU	A-58800/86	1/1987
AU	S-100361	5/1988
AU	B-15399/88	11/1989
AU	B-38613/89	1/1990
AU	50307/93	1/1994
AU	B-44681/93	2/1994
AU	B-59363/94	10/1994
AU	B-59791/94	5/1995

FIG. 1

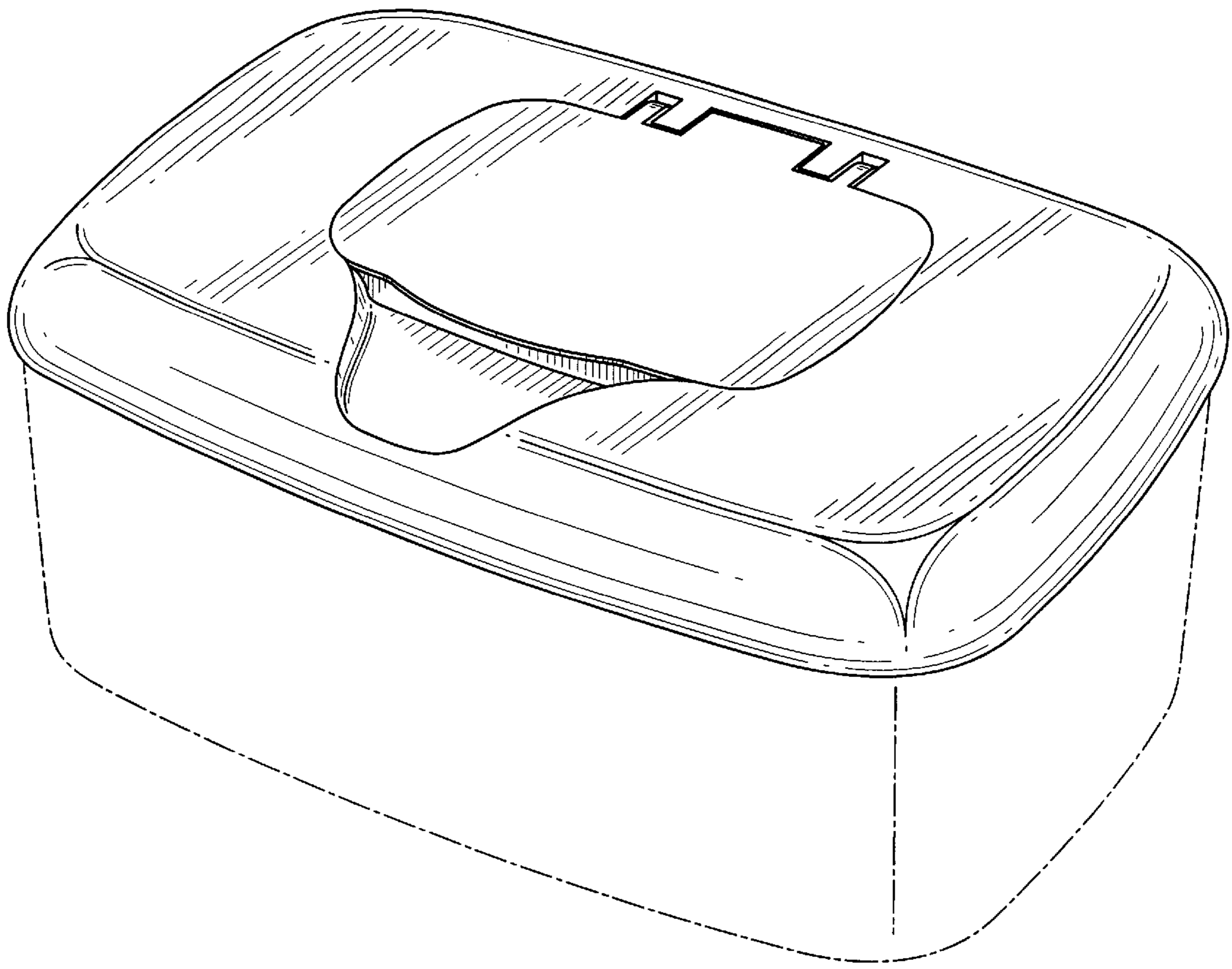

FIG. 2

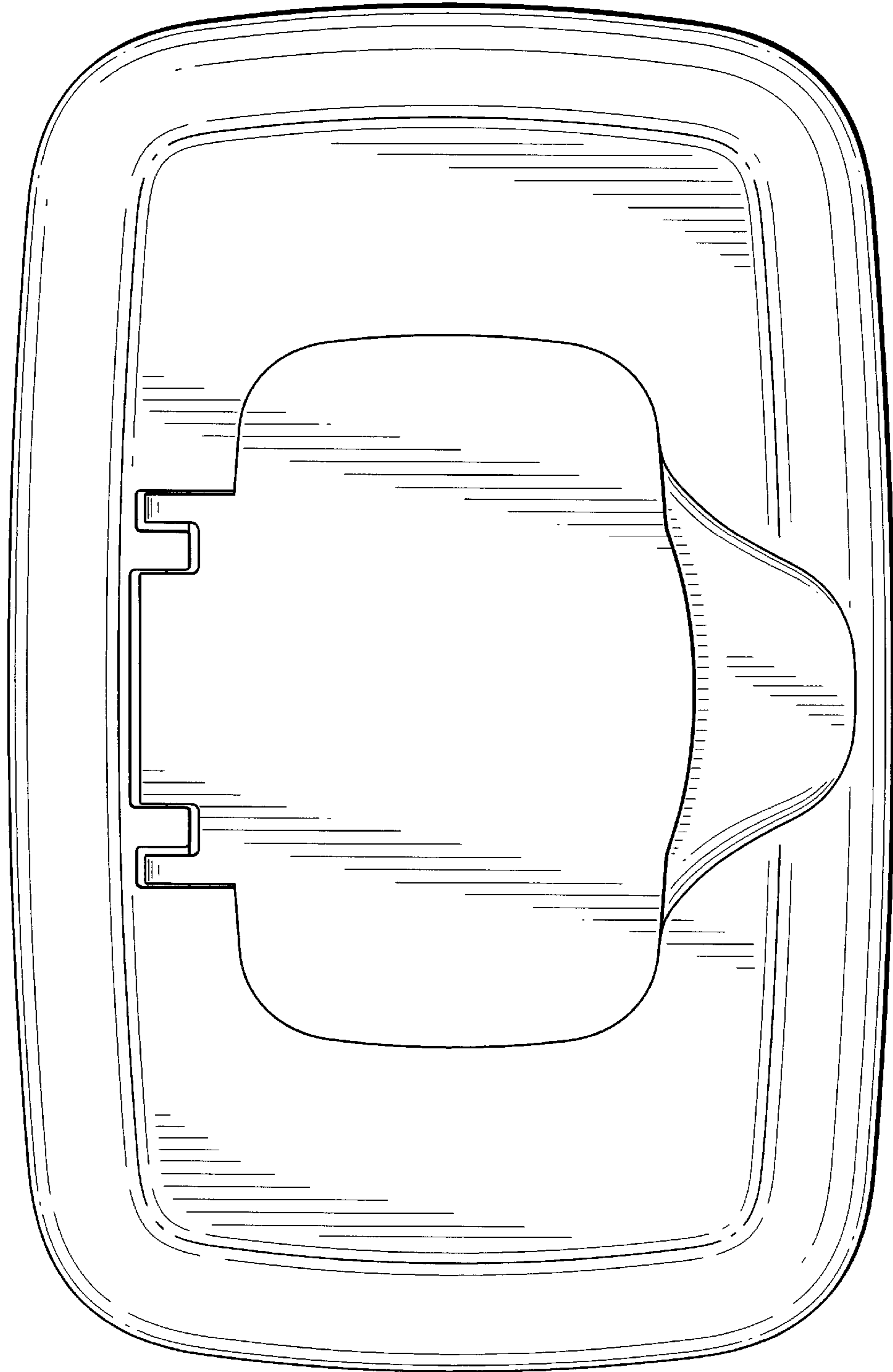

FIG. 3

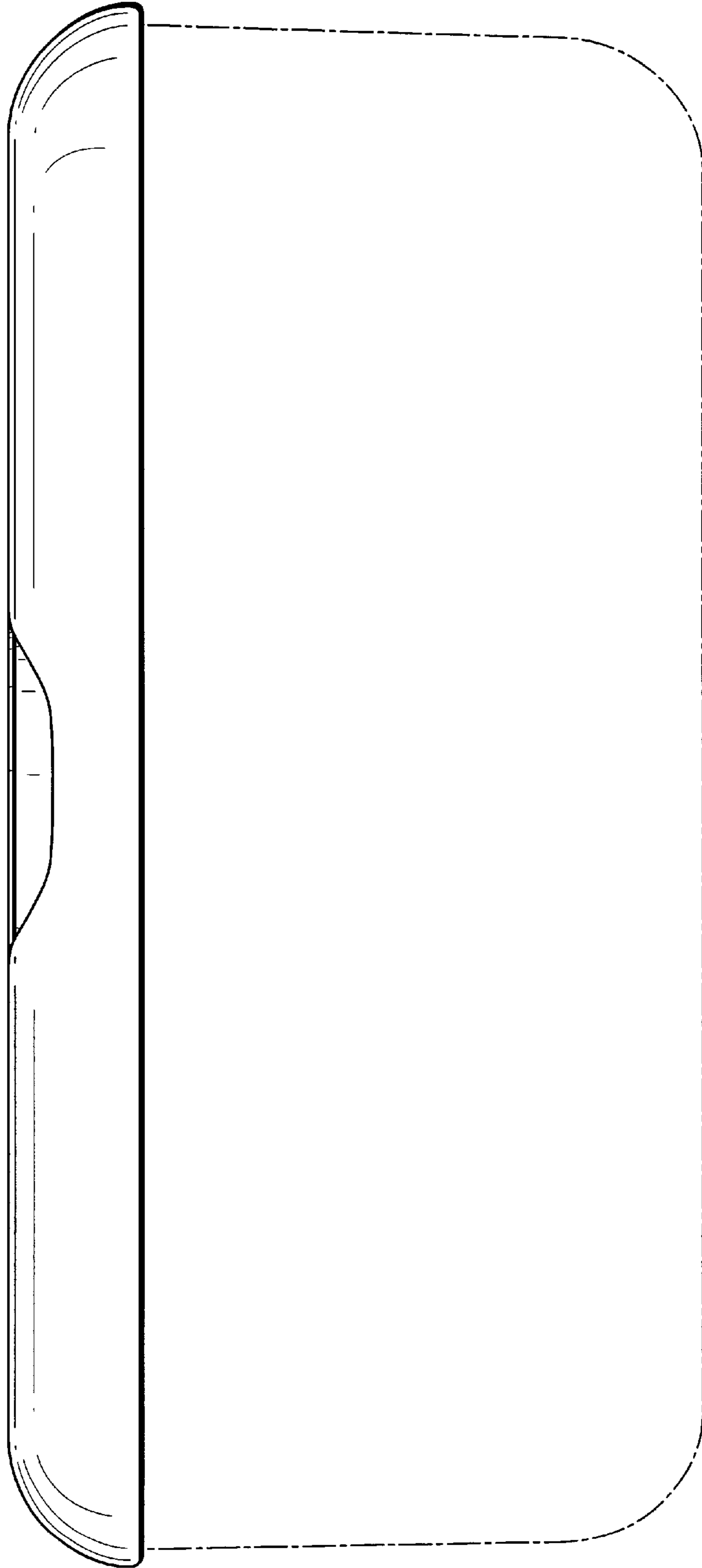

FIG. 4

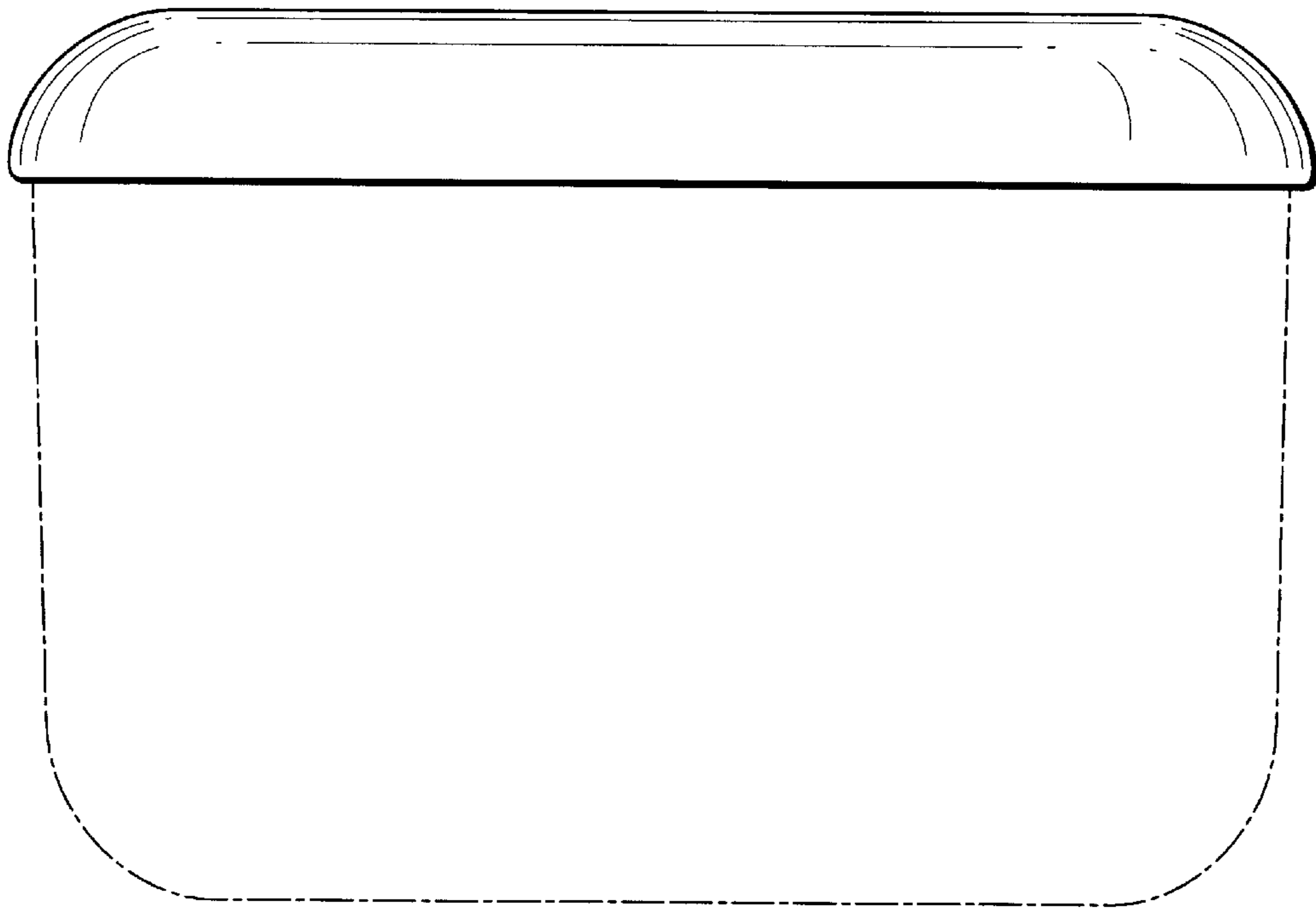

FIG. 5

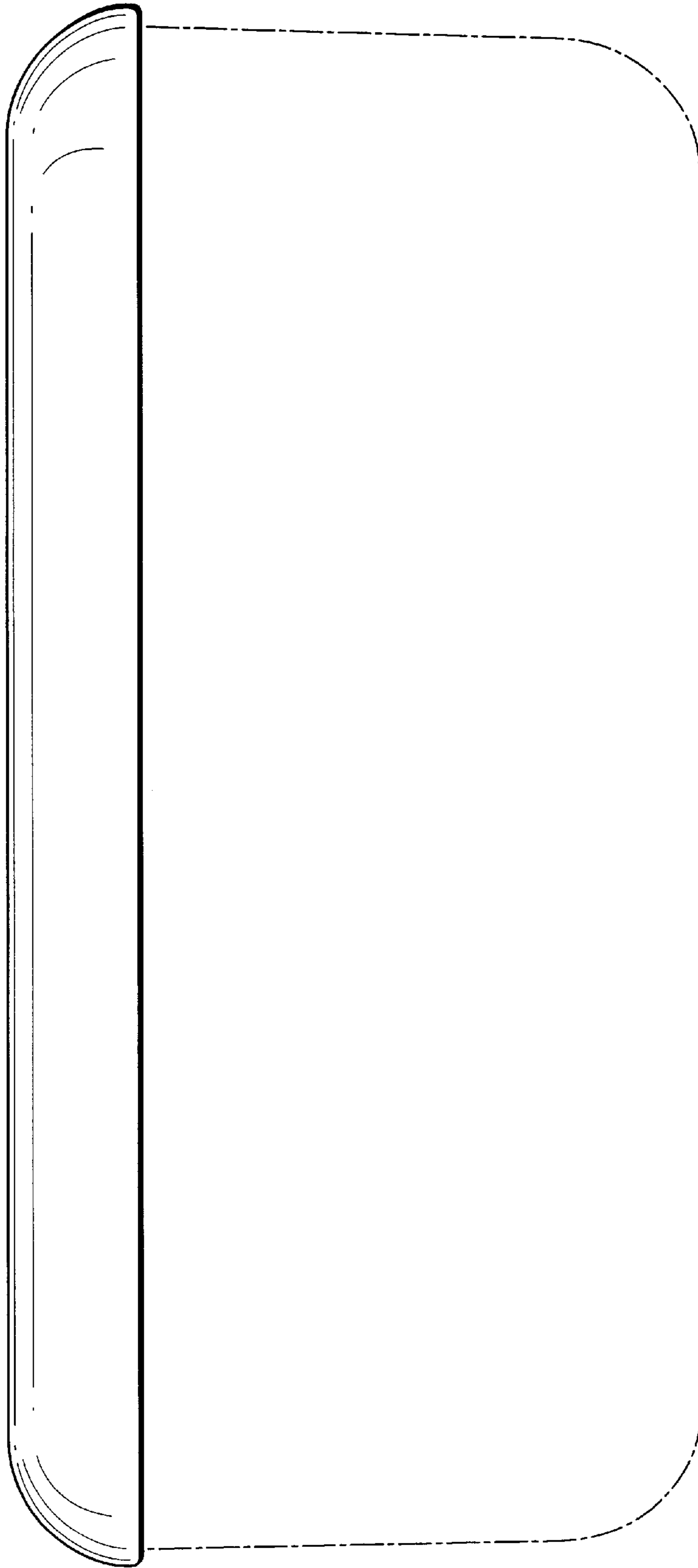

FIG. 6

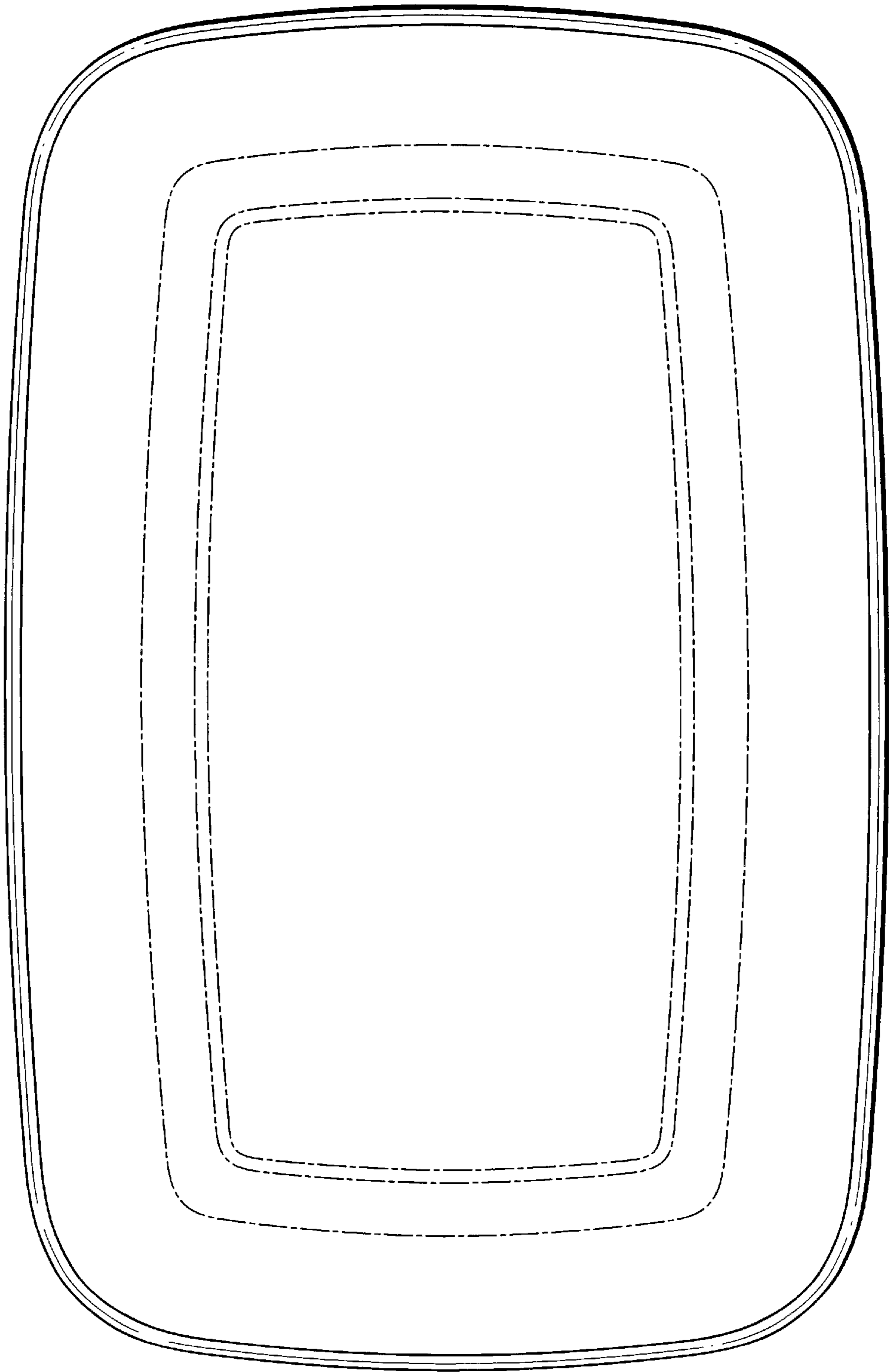

FIG. 7

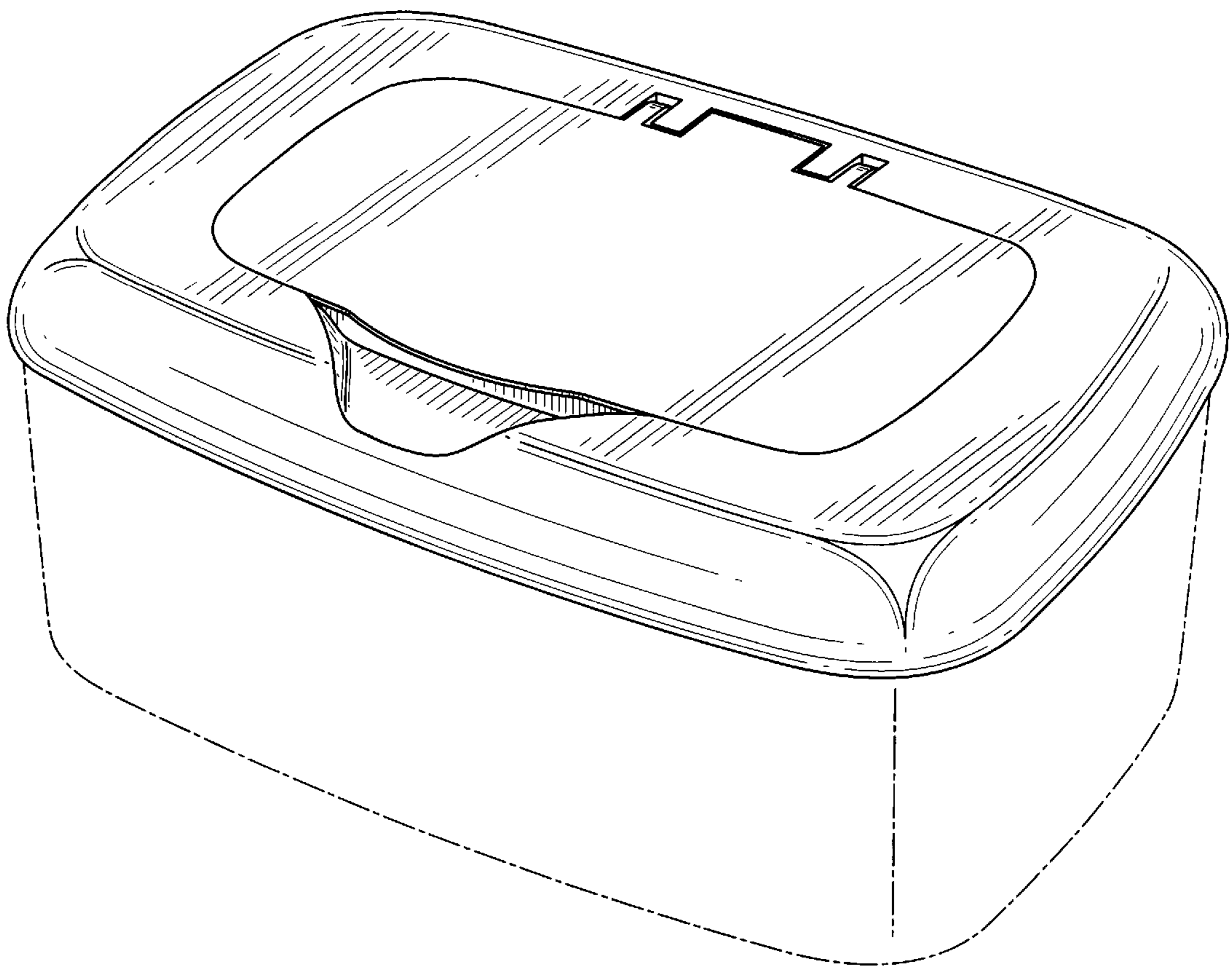

FIG. 8

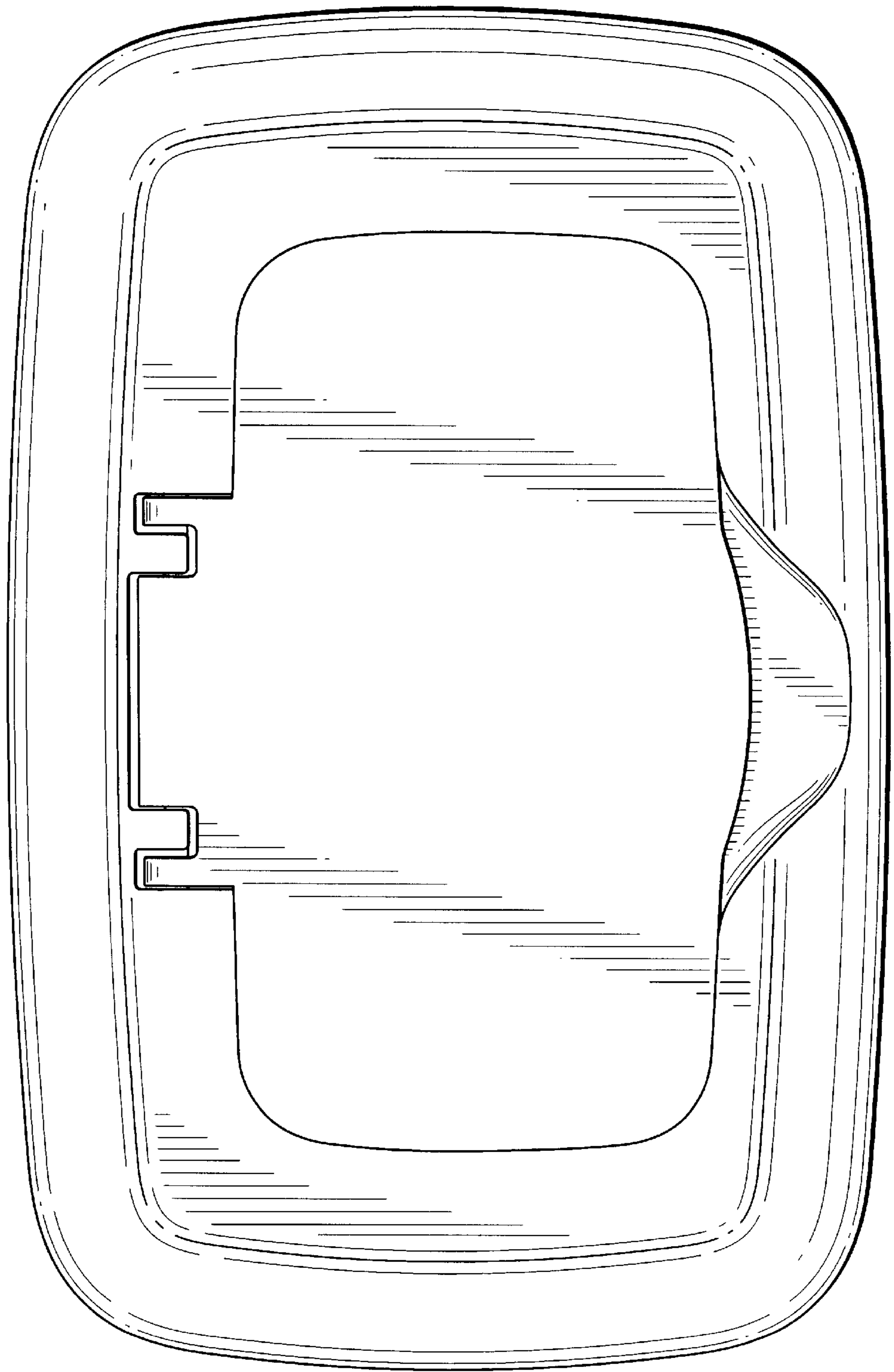

FIG. 9

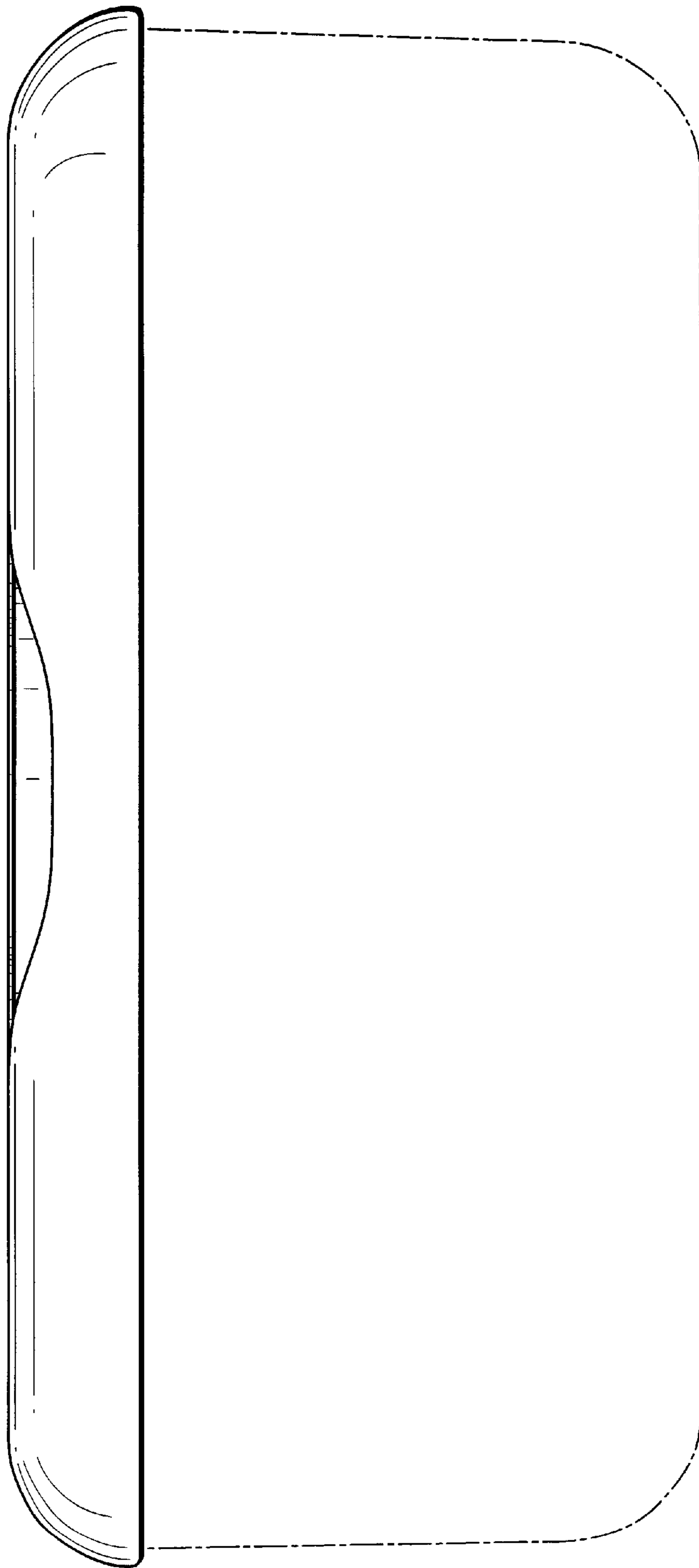

FIG. 10

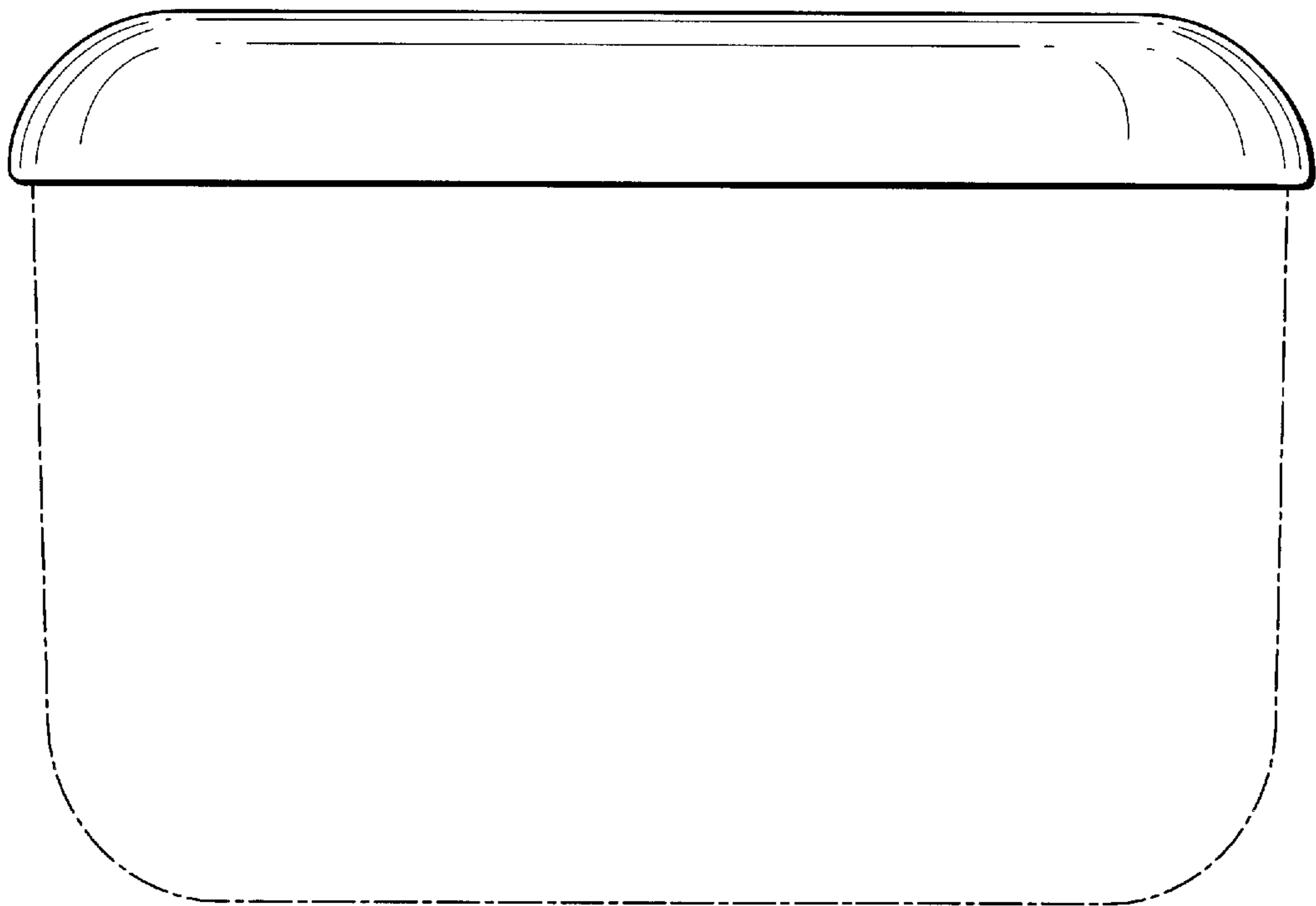

FIG. 11

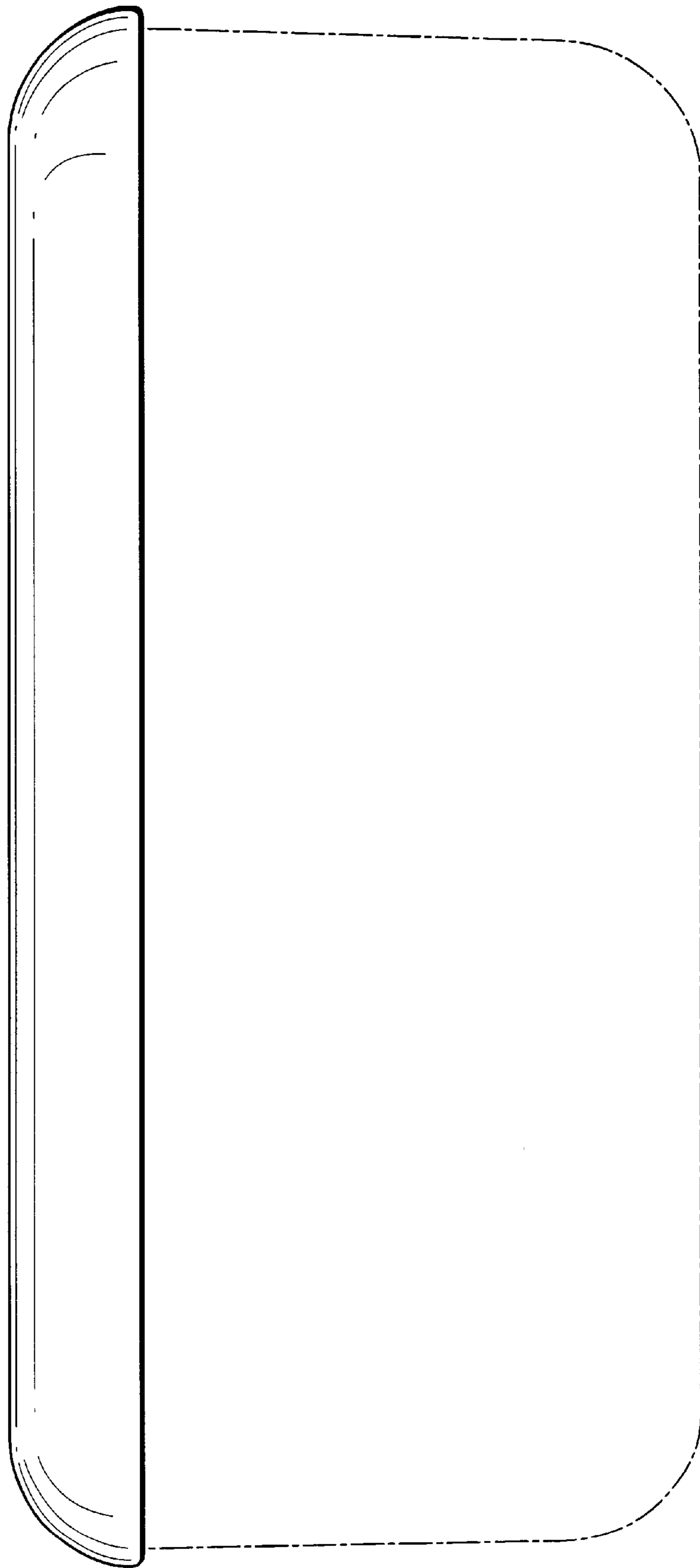

FIG. 12

