



US00D473635S

(12) **United States Design Patent**
Lanius

(10) **Patent No.:** **US D473,635 S**

(45) **Date of Patent:** **** Apr. 22, 2003**

(54) **LAVATORY**

(75) Inventor: **Jason T. Lanius**, Sheboygan, WI (US)

(73) Assignee: **Kohler Co.**, Kohler, WI (US)

(**) Term: **14 Years**

(21) Appl. No.: **29/158,975**

(22) Filed: **Apr. 12, 2002**

(51) **LOC (7) Cl.** **23-02**

(52) **U.S. Cl.** **D23/293.1**

(58) **Field of Search** D23/272-274,
D23/284-292, 293.1, 303, 308; 4/619-620,
624-625, 638, 643-652, 660-661

(56) **References Cited**

U.S. PATENT DOCUMENTS

- D344,787 S * 3/1994 Ohaus et al. D23/293.1
- D412,562 S * 8/1999 Soulier D23/292
- D436,656 S * 1/2001 McKeone D23/293.1
- D446,288 S * 8/2001 McKeone et al. D23/293.1

OTHER PUBLICATIONS

- Undated Eljer catalog ad, p. 2.34, showing an "Estelle" lavatory.
- 1997 Kohler catalog ad, p. 14.28, showing a "Pennington" lavatory.
- 1999 Kallista catalog ad, p. 51, showing a "Pemberley" drop-in lavatory.

1997 Kohler catalog ad, p. 14.4, showing a "Turnings" lavatory.

* cited by examiner

Primary Examiner—Louis S. Zarfes

Assistant Examiner—Robert A. Delehanty

(74) *Attorney, Agent, or Firm*—Quarles & Brady LLP

(57) **CLAIM**

The ornamental design for a lavatory, as shown and described.

DESCRIPTION

In a preferred embodiment, the nature of this product is as a plumbing fixture in the form of a lavatory which is primarily useful for washing the body parts of humans.

FIG. 1 is a left, top, front perspective view of a lavatory embodying my new design;

FIG. 2 is a top plan view thereof;

FIG. 3 is a front elevational view thereof;

FIG. 4 is a left side elevational view thereof, the right side elevational view being a mirror image of the left side shown;

FIG. 5 is a cross-sectional view thereof taken along line 5—5 of FIG. 2;

FIG. 6 is a rear elevational view thereof (which is shown for illustration only as this is normally not visible during use or marketing); and,

FIG. 7 is a bottom plan view thereof.

The broken line representations of holes in FIGS. 1, 2, 5, and 7, and of ribs in FIGS. 1, 3, 4, 6, and 7, are for the purpose of illustration only, and form no part of the claimed design.

1 Claim, 3 Drawing Sheets

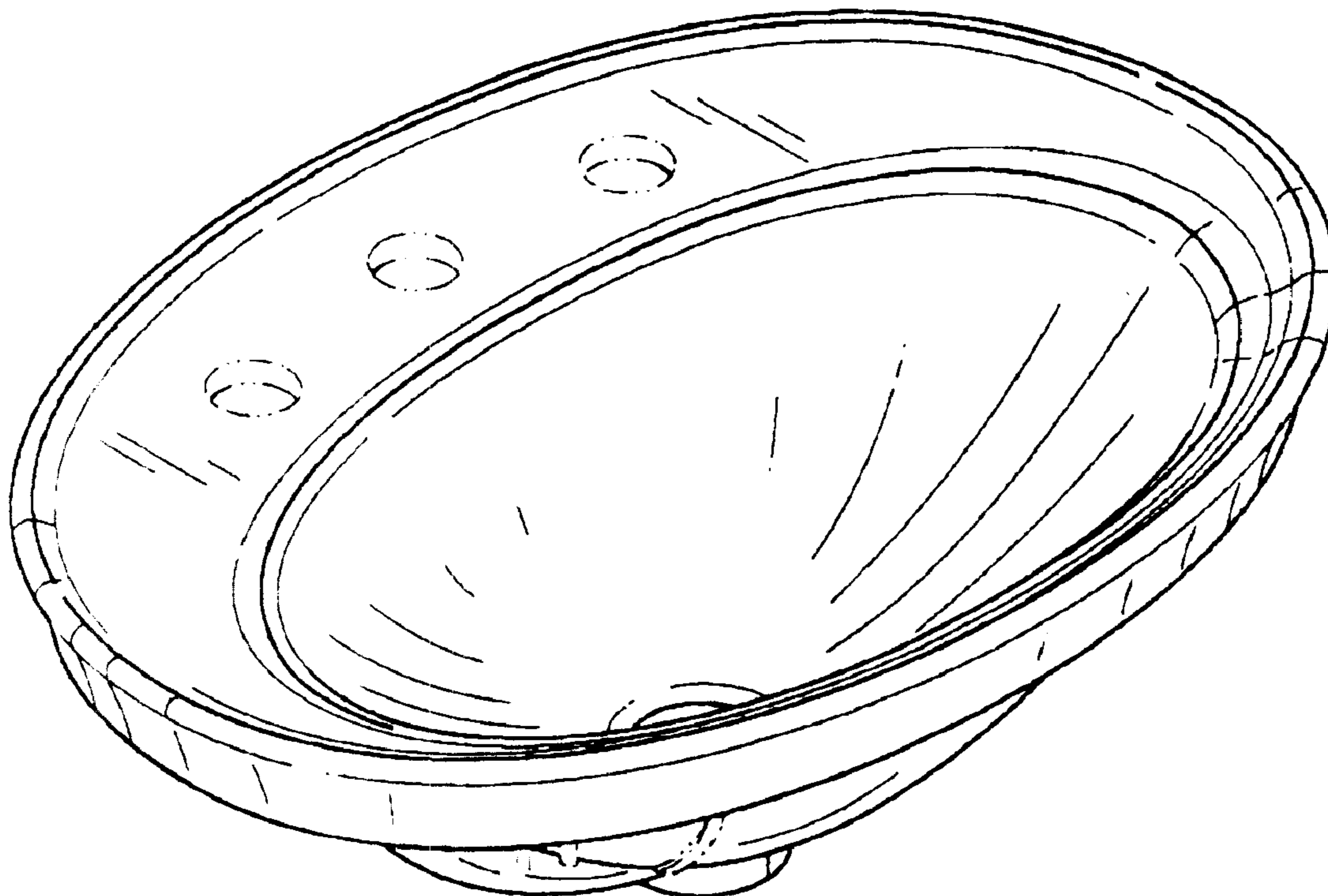

FIG. 1

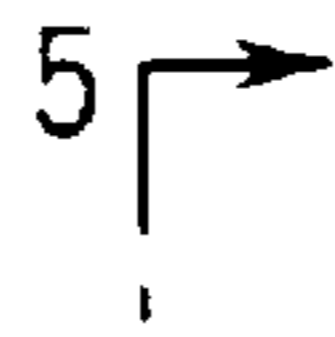
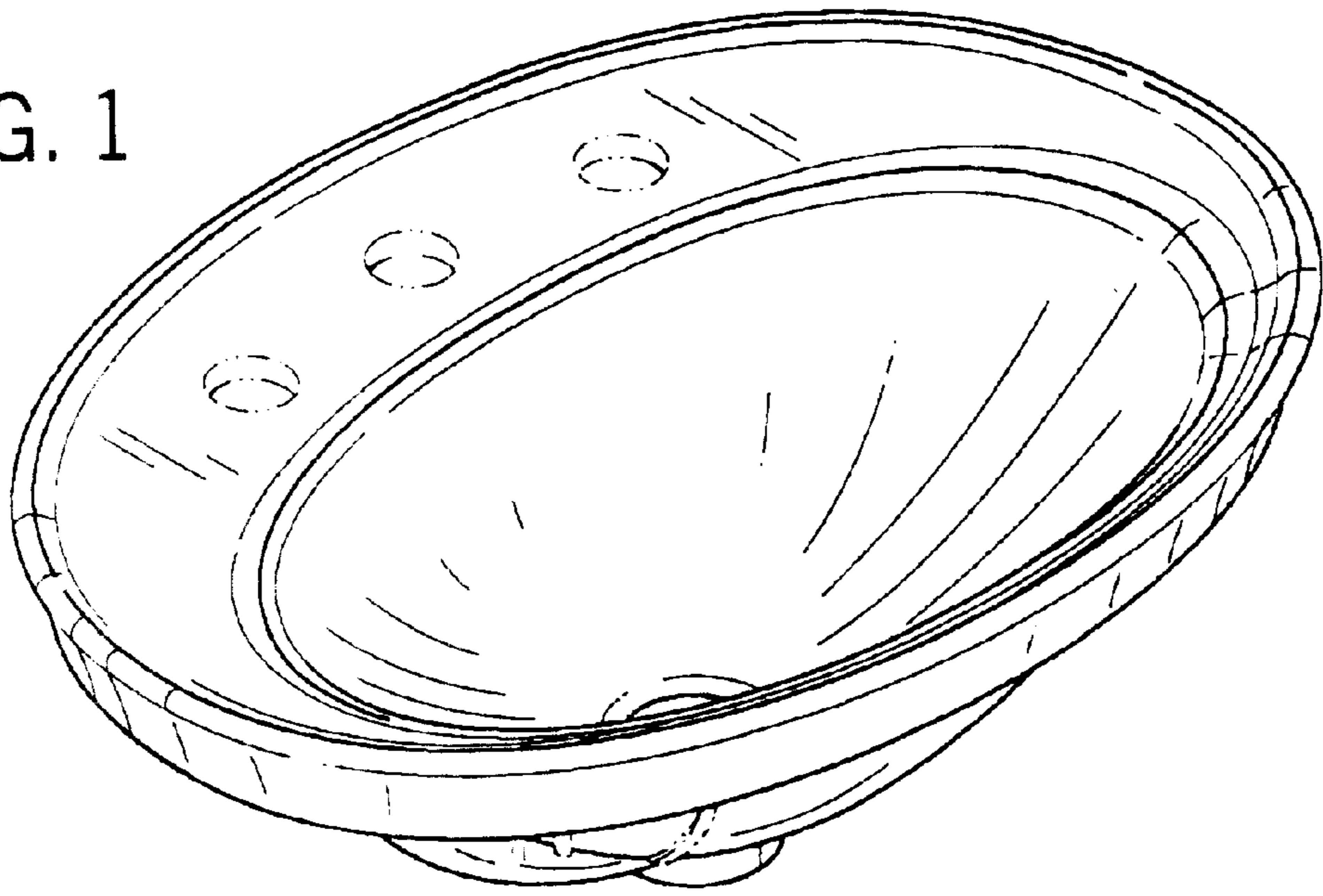

FIG. 2

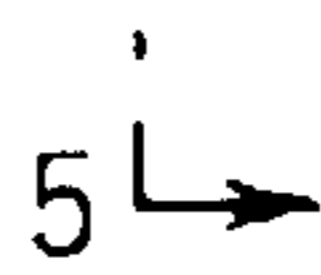
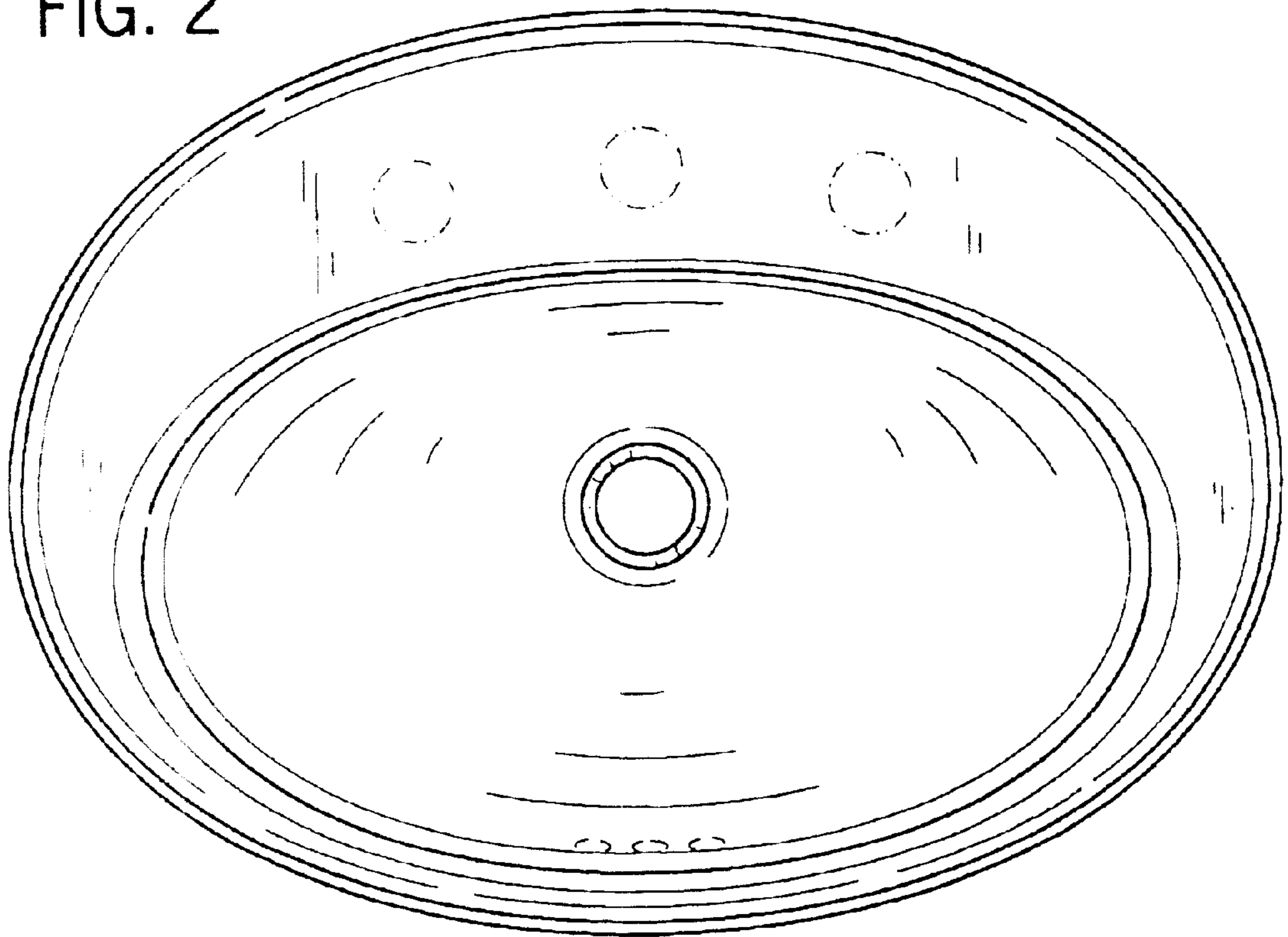

FIG. 3

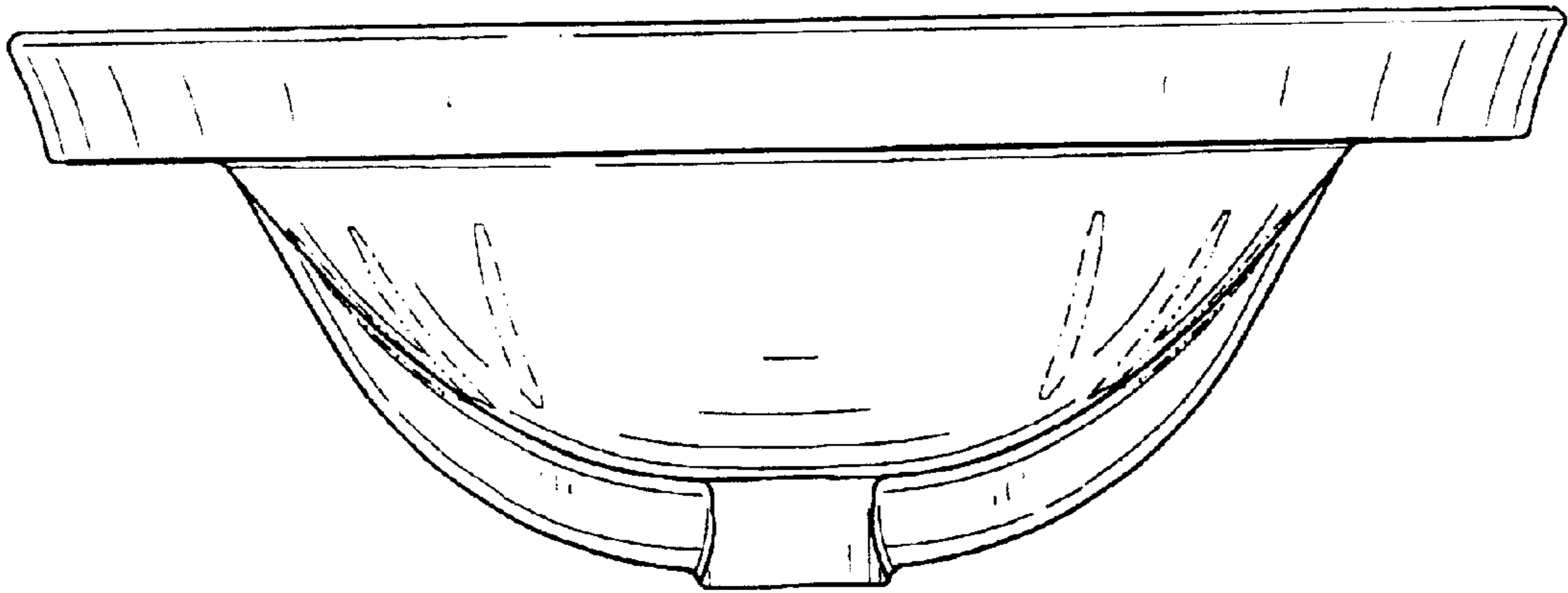

FIG. 4

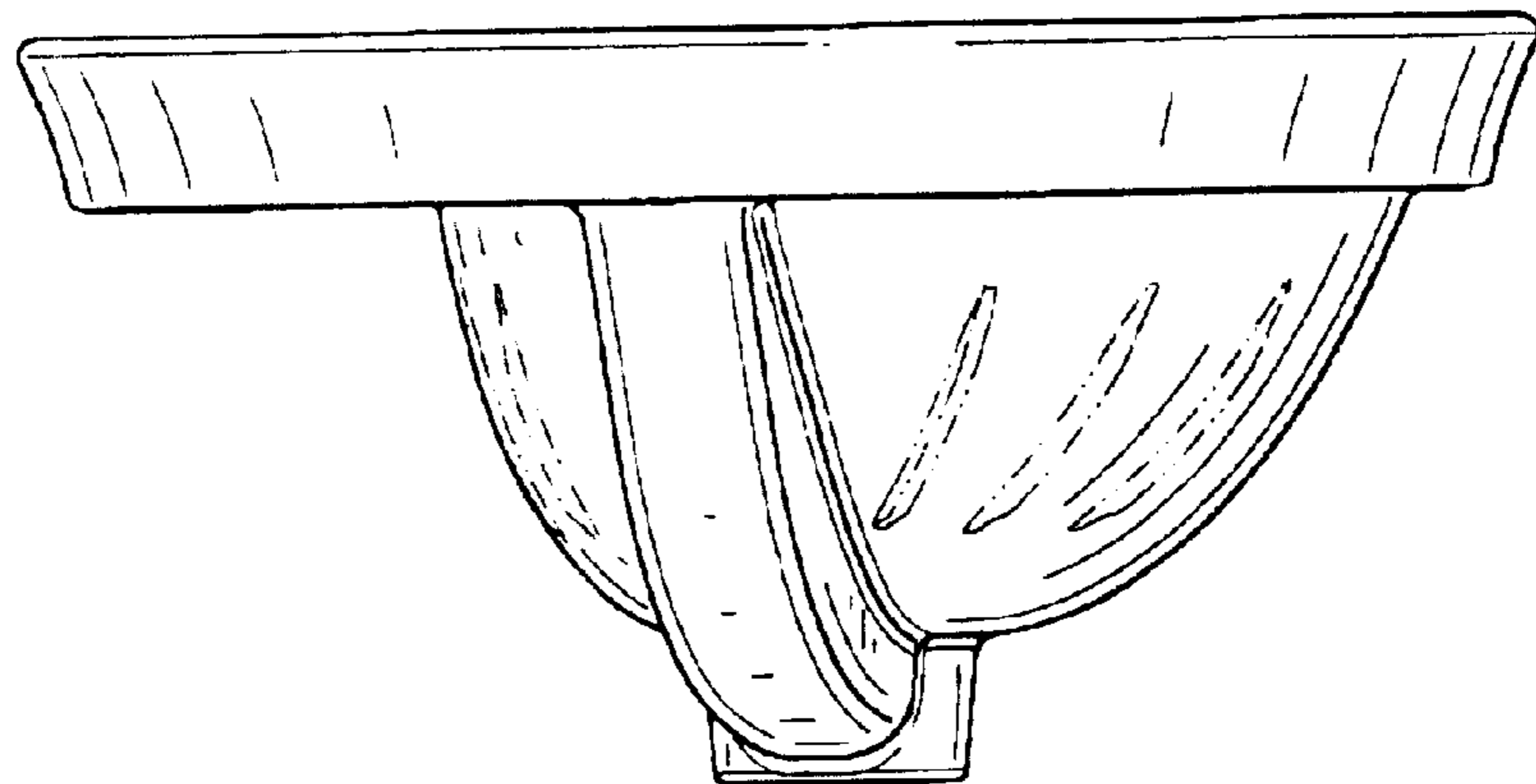

FIG. 5

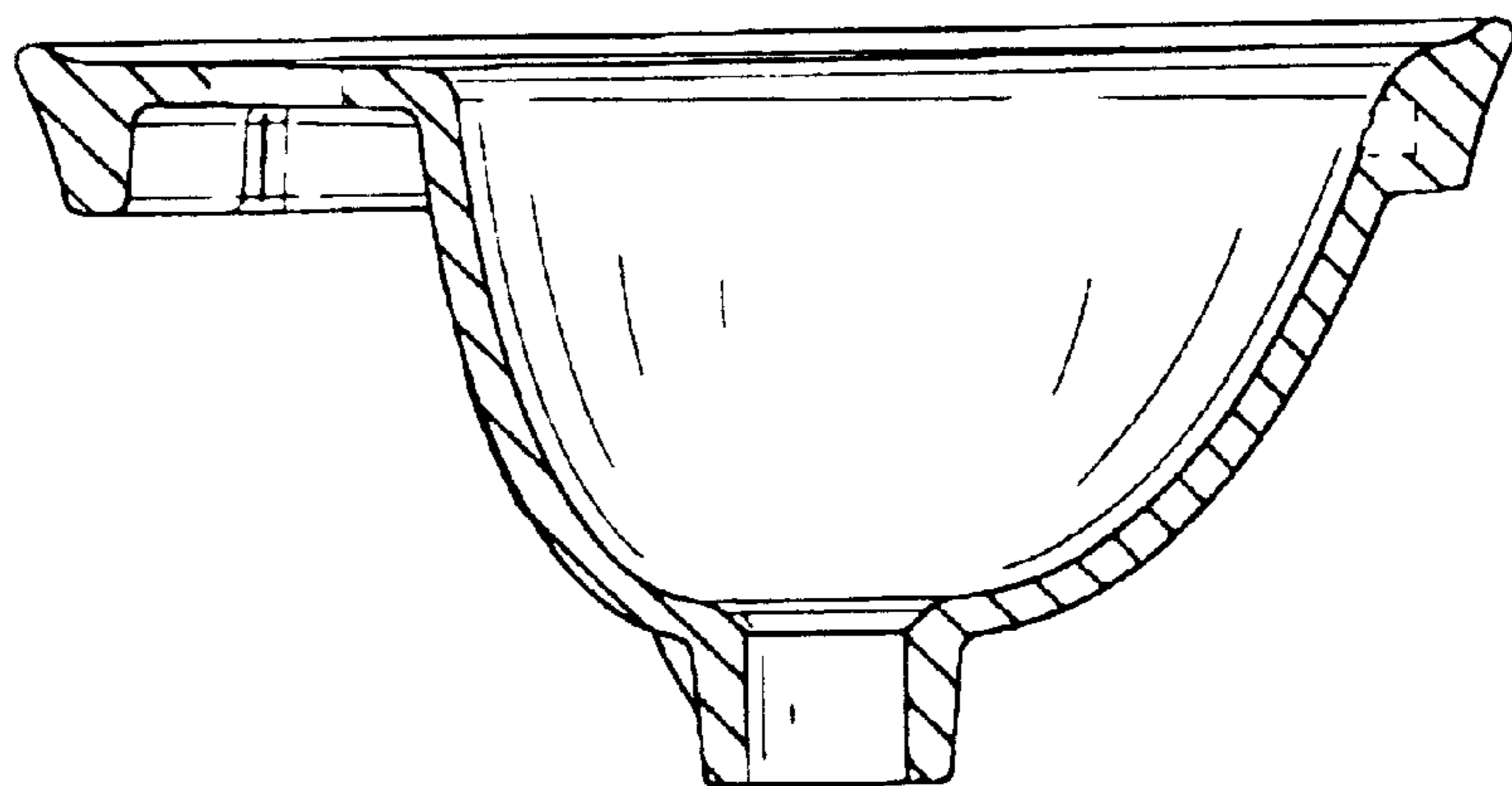

FIG. 6

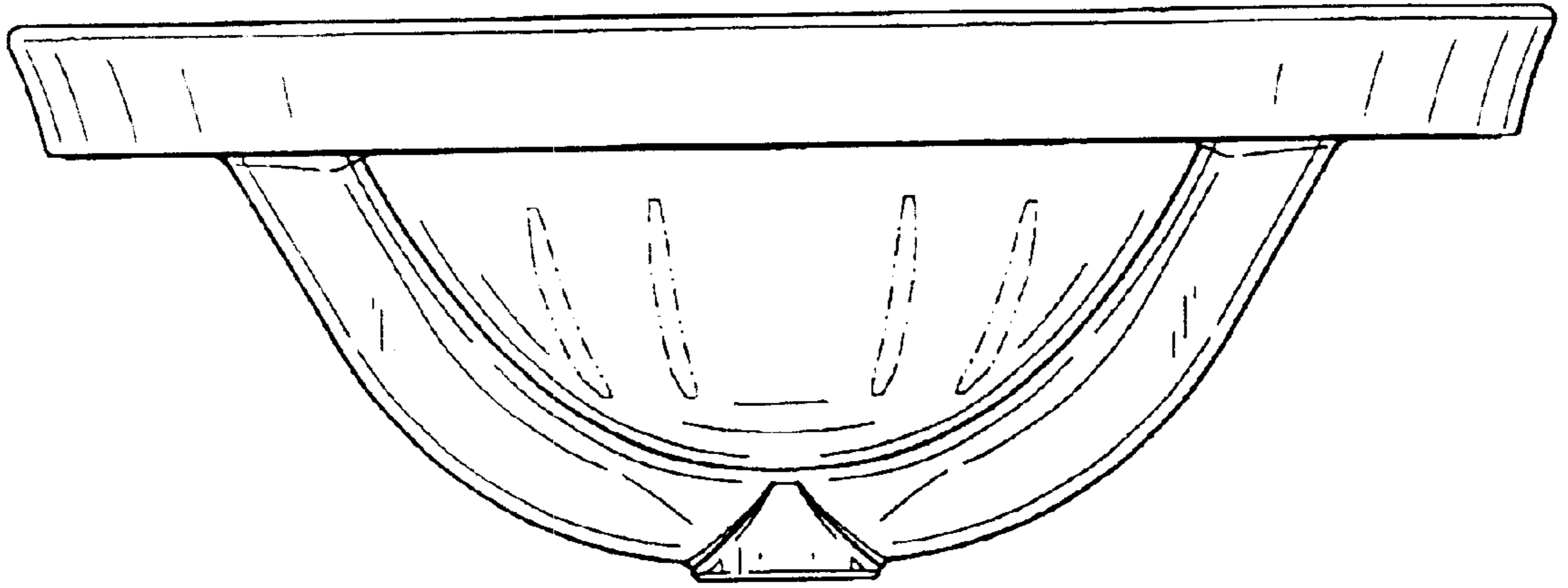

FIG. 7

