



US00D473585S

(12) **United States Design Patent**
Carlson

(10) **Patent No.:** **US D473,585 S**

(45) **Date of Patent:** **** Apr. 22, 2003**

(54) **REMOTE KEYBOARD MUSICAL INSTRUMENT**

(76) **Inventor:** **Charles A. Carlson**, 440 Zinnia La.,
Plymouth, MN (US) 55441

(**) **Term:** **14 Years**

(21) **Appl. No.:** **29/155,704**

(22) **Filed:** **Feb. 15, 2002**

(51) **LOC (7) Cl.** **17-01**

(52) **U.S. Cl.** **D17/1**

(58) **Field of Search** D17/1-2, 5-7,
D17/9, 24, 99; D21/409, 324; 84/174, 175,
177, 180, 186.1, 172, 678, 423 R, 477 R-478,
DIG. 17, 170-171, 82, 719, 744; 446/397,
143

(56) **References Cited**

U.S. PATENT DOCUMENTS

D211,494 S	*	6/1968	Spranger	D17/5
3,705,948 A		12/1972	Tomisawa		
3,941,023 A	*	3/1976	Thomas et al.	84/715
D254,496 S		3/1980	Hill		
D256,366 S		8/1980	Dworsky		
4,244,261 A		1/1981	Adachi		

D260,654 S	*	9/1981	Antonelli	D17/6
4,742,749 A	*	5/1988	Kira et al.	84/179
D307,287 S		4/1990	Koide		
D312,091 S		11/1990	Amiya		
D351,612 S		10/1994	Eventoff		
D389,507 S	*	1/1998	Honda	D17/1
6,180,859 B1	*	1/2001	Konishi	84/174
D441,003 S		4/2001	Chan		
D444,492 S		7/2001	Saito		

* cited by examiner

Primary Examiner—Ruth McInroy

(57) **CLAIM**

The ornamental design of a remote keyboard musical instrument, as shown and described.

DESCRIPTION

FIG. 1 is a perspective view of the remote keyboard musical instrument showing my new design;
FIG. 2 is a top plan view thereof;
FIG. 3 is a front elevational view thereof;
FIG. 4 is a rear elevational view thereof;
FIG. 5 is a left side elevational view thereof;
FIG. 6 is a right side elevational view thereof; and,
FIG. 7 is a bottom plan view thereof.

1 Claim, 4 Drawing Sheets

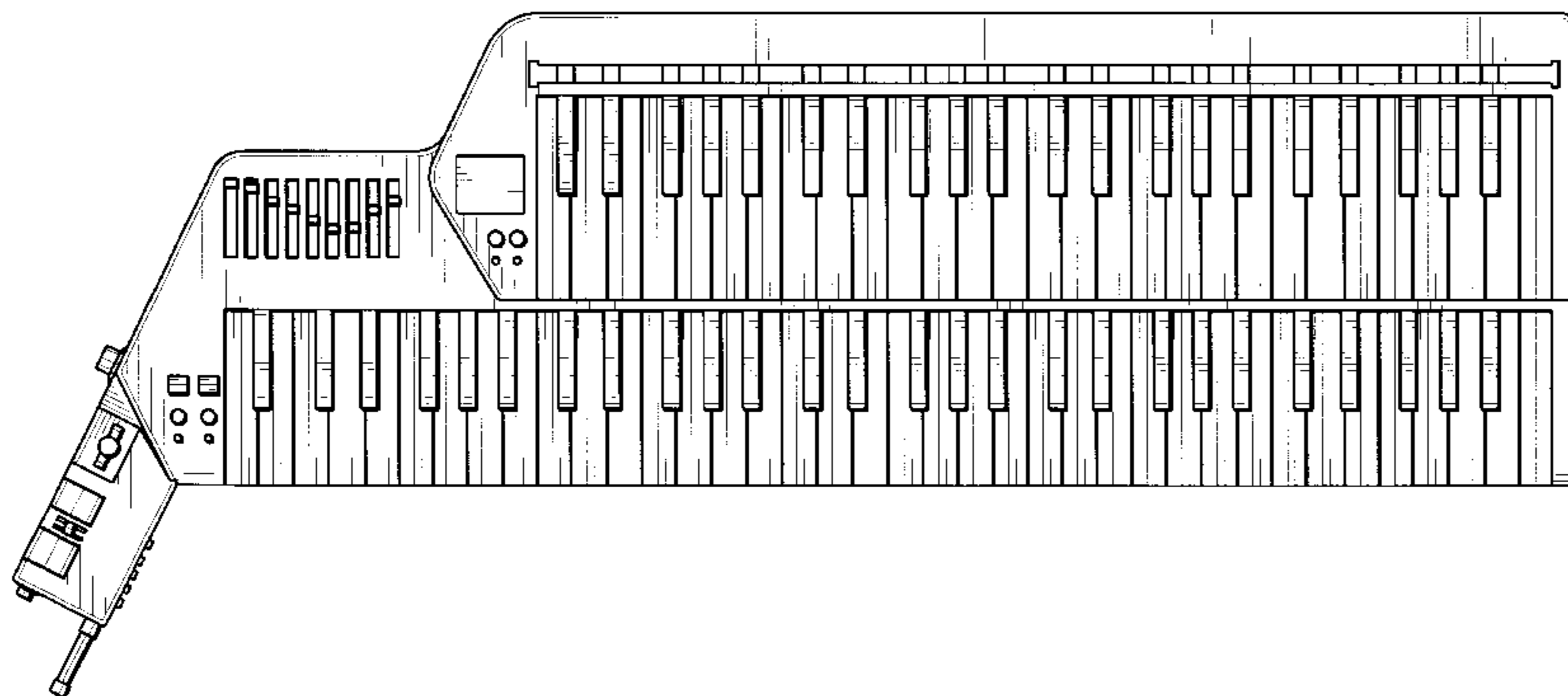
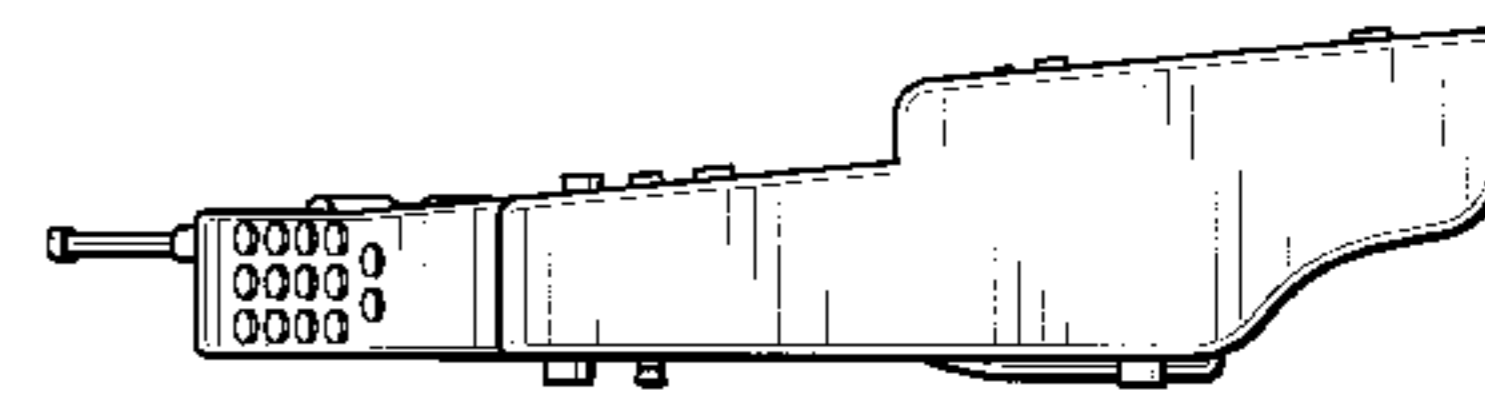
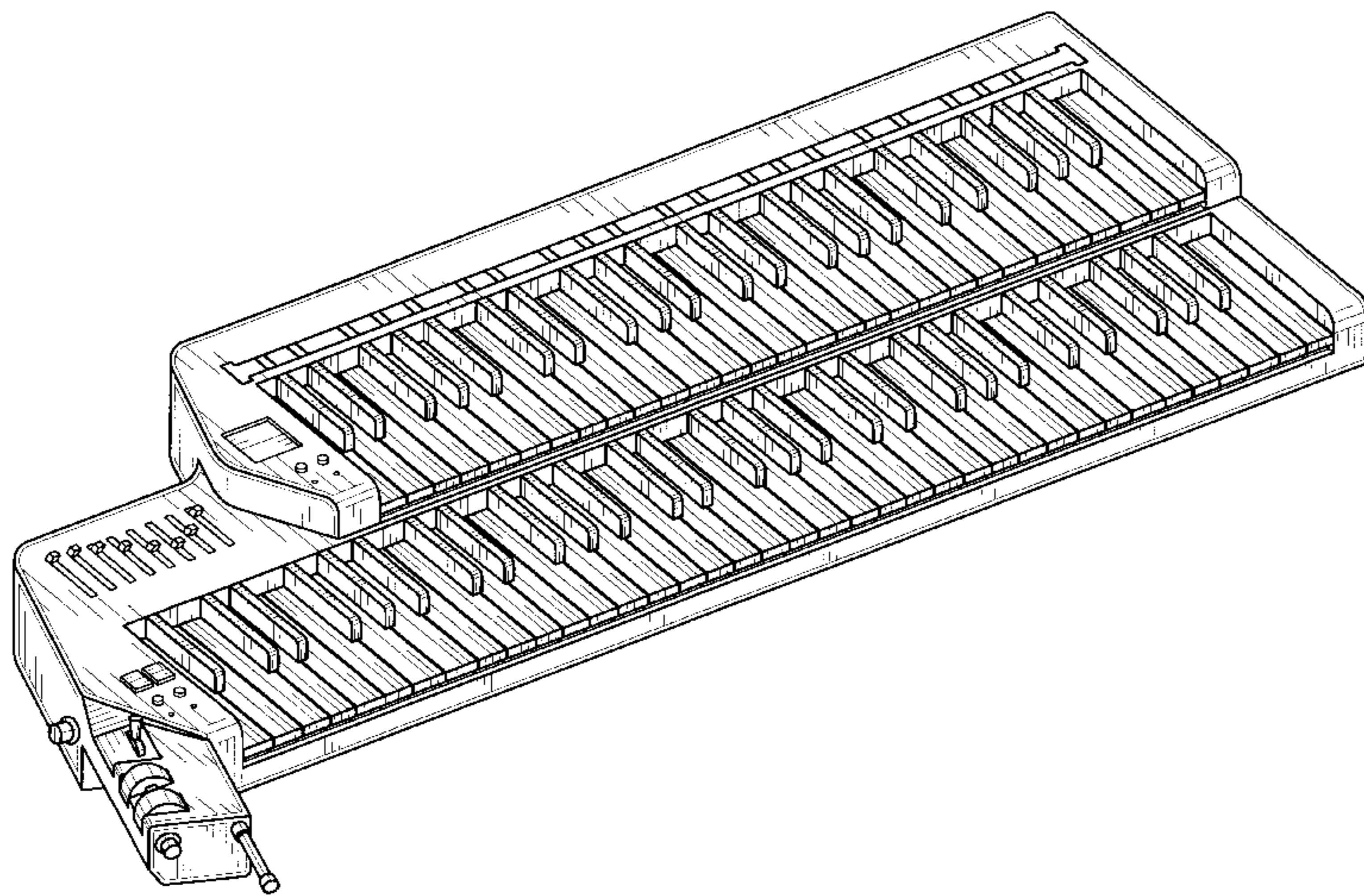

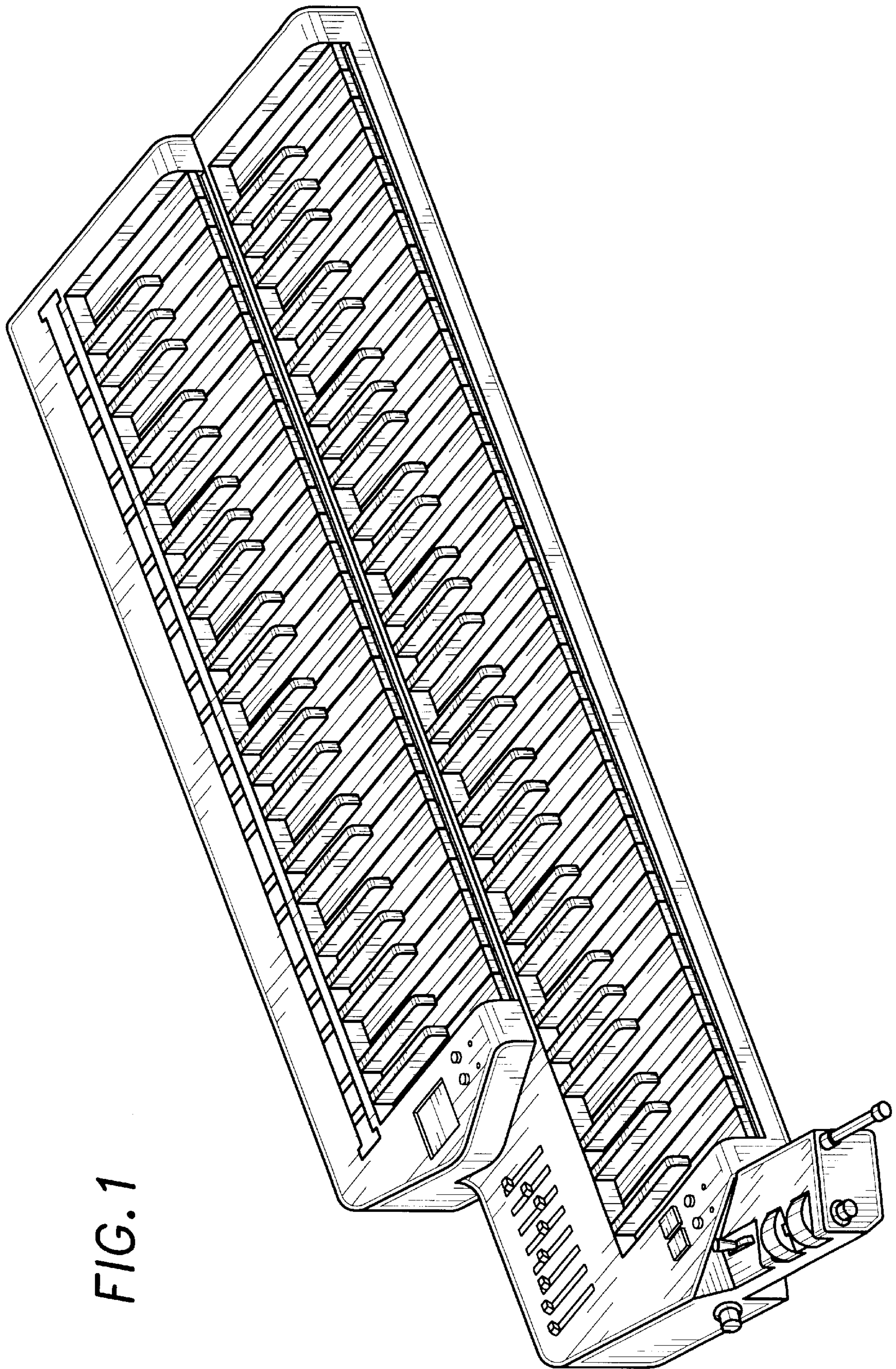

FIG. 1

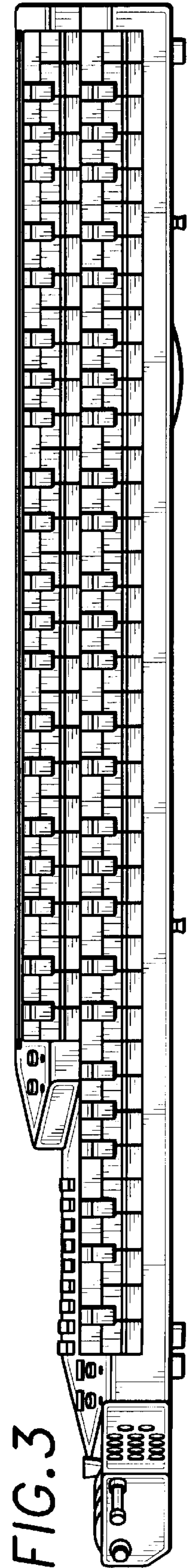
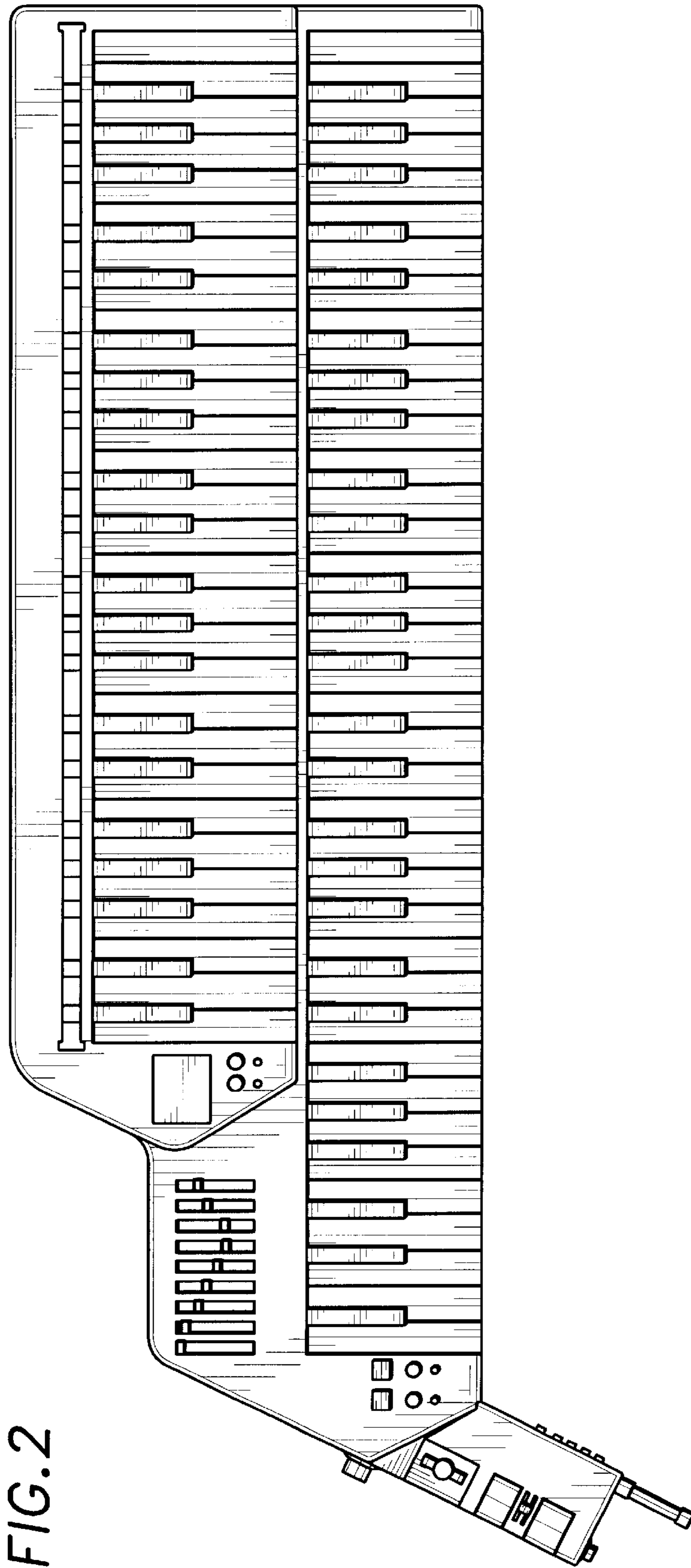

FIG. 4

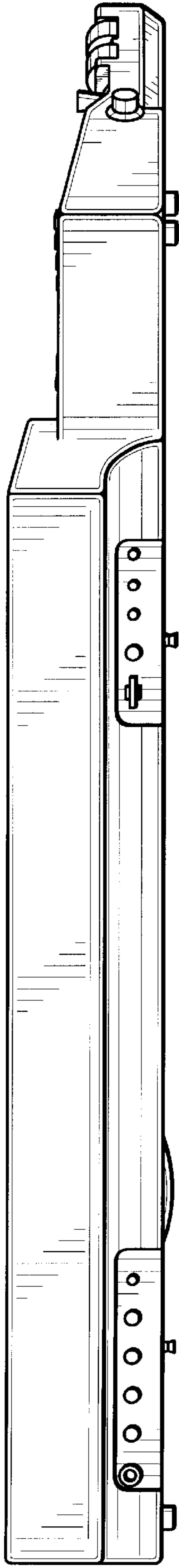

FIG. 5

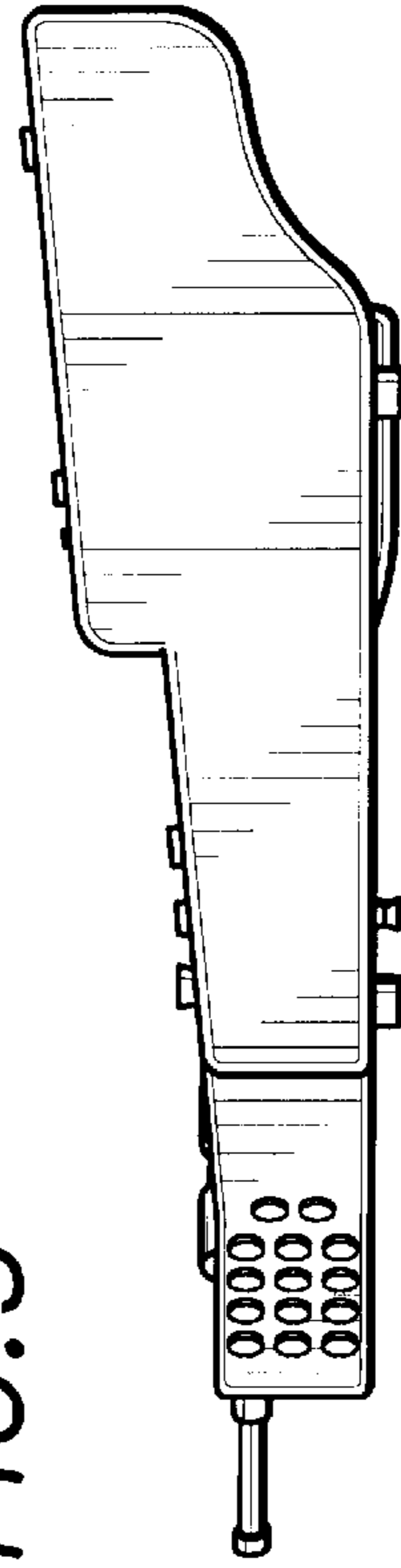
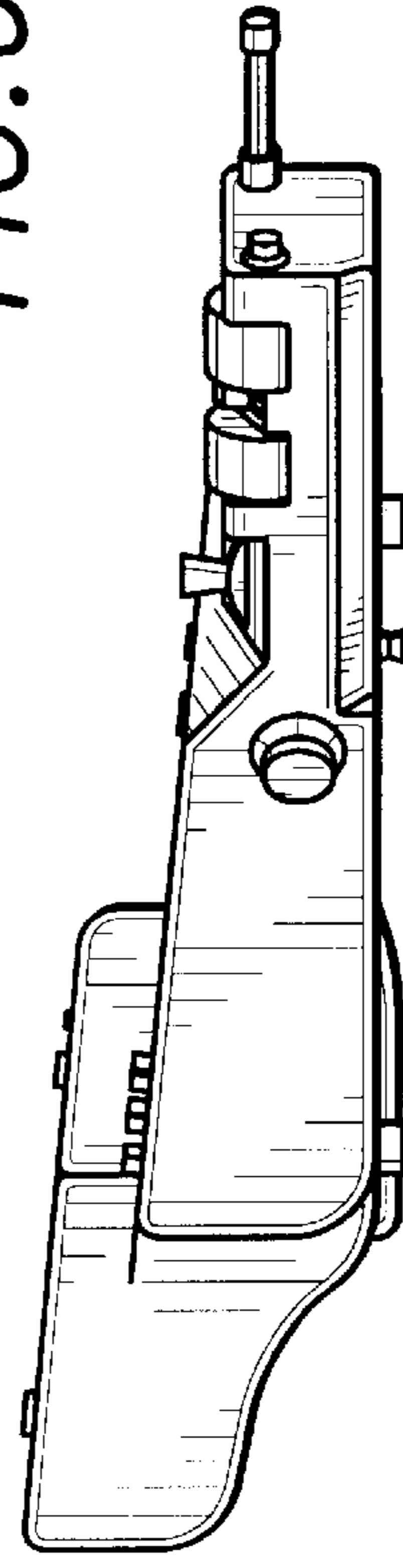

FIG. 6



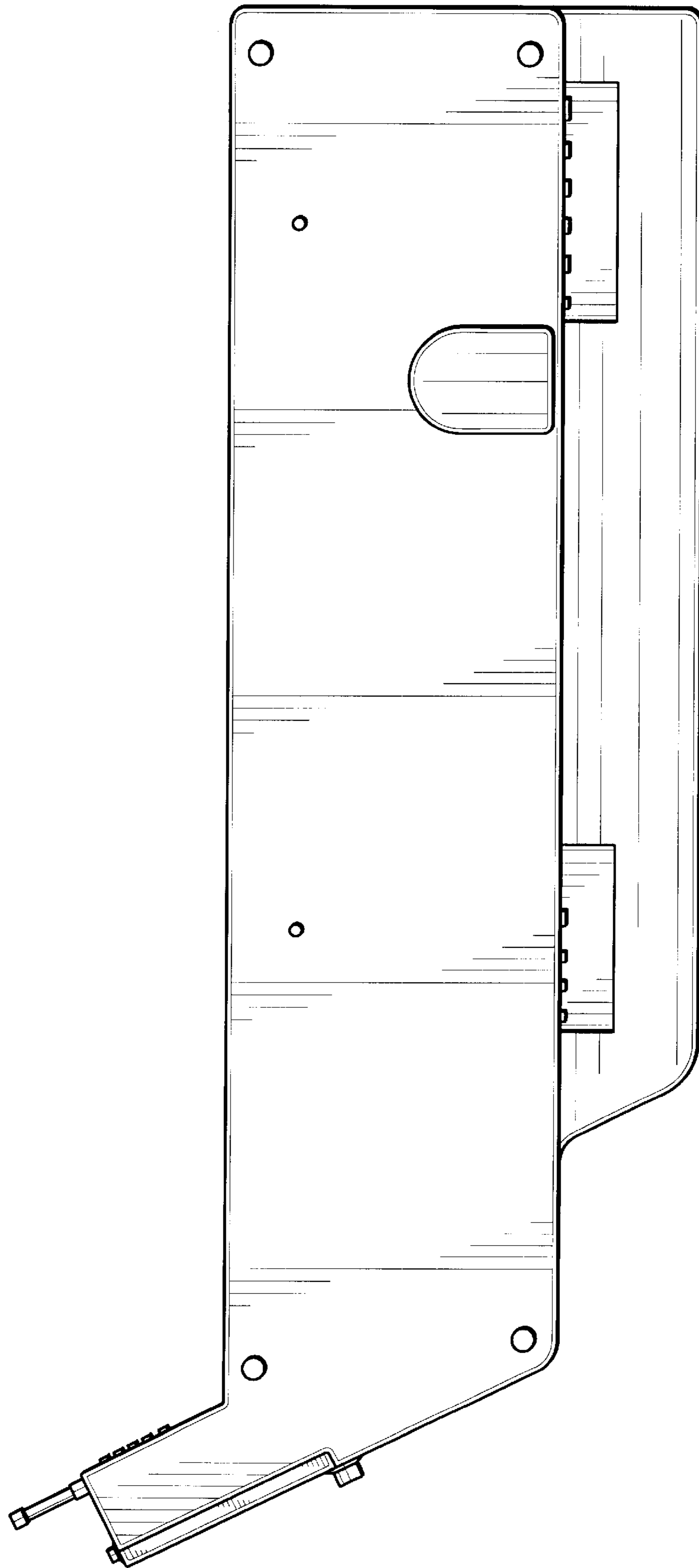

FIG. 7