



US00D473533S

(12) **United States Design Patent**  
**Tan et al.**

(10) **Patent No.:** **US D473,533 S**

(45) **Date of Patent:** **\*\* Apr. 22, 2003**

(54) **HOUSING FOR A TELEPHONE**

(75) Inventors: **William Tan**, Los Angeles, CA (US);  
**Ernesto V. Quinteros**, Los Angeles, CA (US)

(73) Assignee: **Belkin Corporation**, Compton, CA (US)

(\*\*) Term: **14 Years**

(21) Appl. No.: **29/143,510**

(22) Filed: **Jun. 15, 2001**

(51) **LOC (7) Cl.** ..... **14-03**

(52) **U.S. Cl.** ..... **D14/138**

(58) **Field of Search** ..... D14/137, 138,  
D14/218, 147-148, 247-248, 144, 341-347;  
379/433.01-433.13, 419, 434, 428.01-428.04,  
420.01-420.04, 440; 455/550-575, 90

(56) **References Cited**

**U.S. PATENT DOCUMENTS**

- D353,809 S \* 12/1994 Nuovo et al. .... D14/138
- D415,489 S \* 10/1999 Ke ..... D14/138
- D420,680 S \* 2/2000 Curtis ..... D14/248
- D421,004 S \* 2/2000 Curtis ..... D14/138
- D421,435 S \* 3/2000 Haase et al. .... D14/137
- D422,282 S \* 4/2000 Curtis ..... D14/248
- D422,585 S \* 4/2000 Ng et al. .... D14/137
- D422,597 S \* 4/2000 Finkbeiner ..... D14/248

- D425,057 S \* 5/2000 Finkbeiner ..... D14/138
- D425,906 S \* 5/2000 Finkbeiner ..... D14/248
- D426,531 S \* 6/2000 Chikaraishi et al. .... D14/138
- D428,001 S \* 7/2000 Curtis ..... D14/248
- D428,401 S \* 7/2000 Curtis ..... D14/138
- D433,398 S \* 11/2000 Meyer et al. .... D14/138
- D440,952 S \* 4/2001 Carvalho ..... D14/138
- D448,022 S \* 9/2001 Higashi et al. .... D14/248
- D448,355 S \* 9/2001 Higashi et al. .... D14/138
- D450,316 S \* 11/2001 Vuolteenaho et al. .... D14/248
- D450,671 S \* 11/2001 Langford et al. .... D14/138
- D451,913 S \* 12/2001 Vuolteenaho et al. .... D14/248
- D452,235 S \* 12/2001 Langford et al. .... D14/248

\* cited by examiner

*Primary Examiner*—Jeffrey Asch

(74) *Attorney, Agent, or Firm*—Bryan Cave LLP

(57) **CLAIM**

We claim the ornamental design for the housing for a telephone, as shown and described.

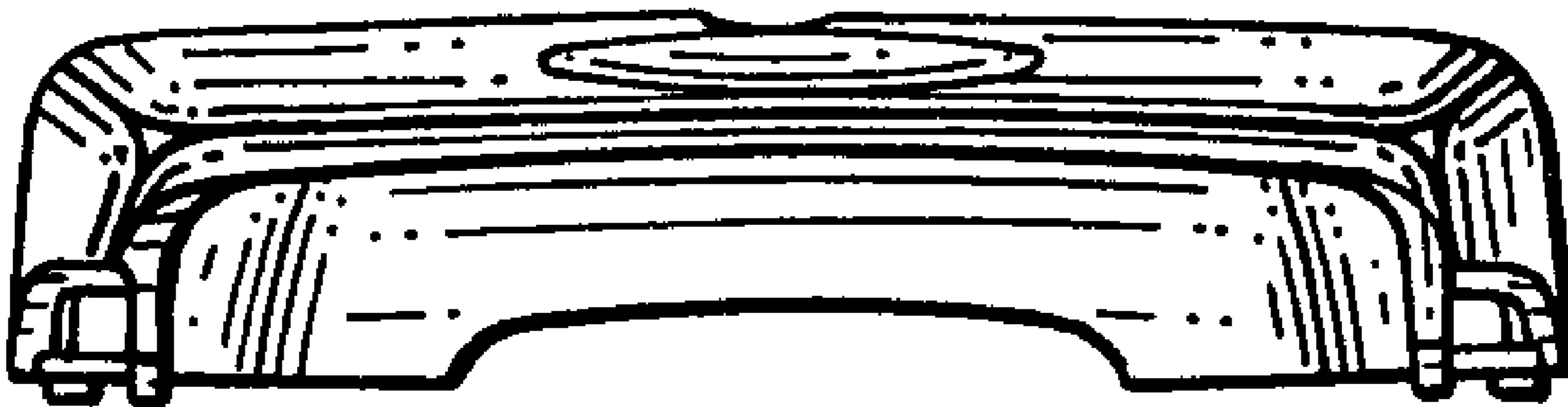
**DESCRIPTION**

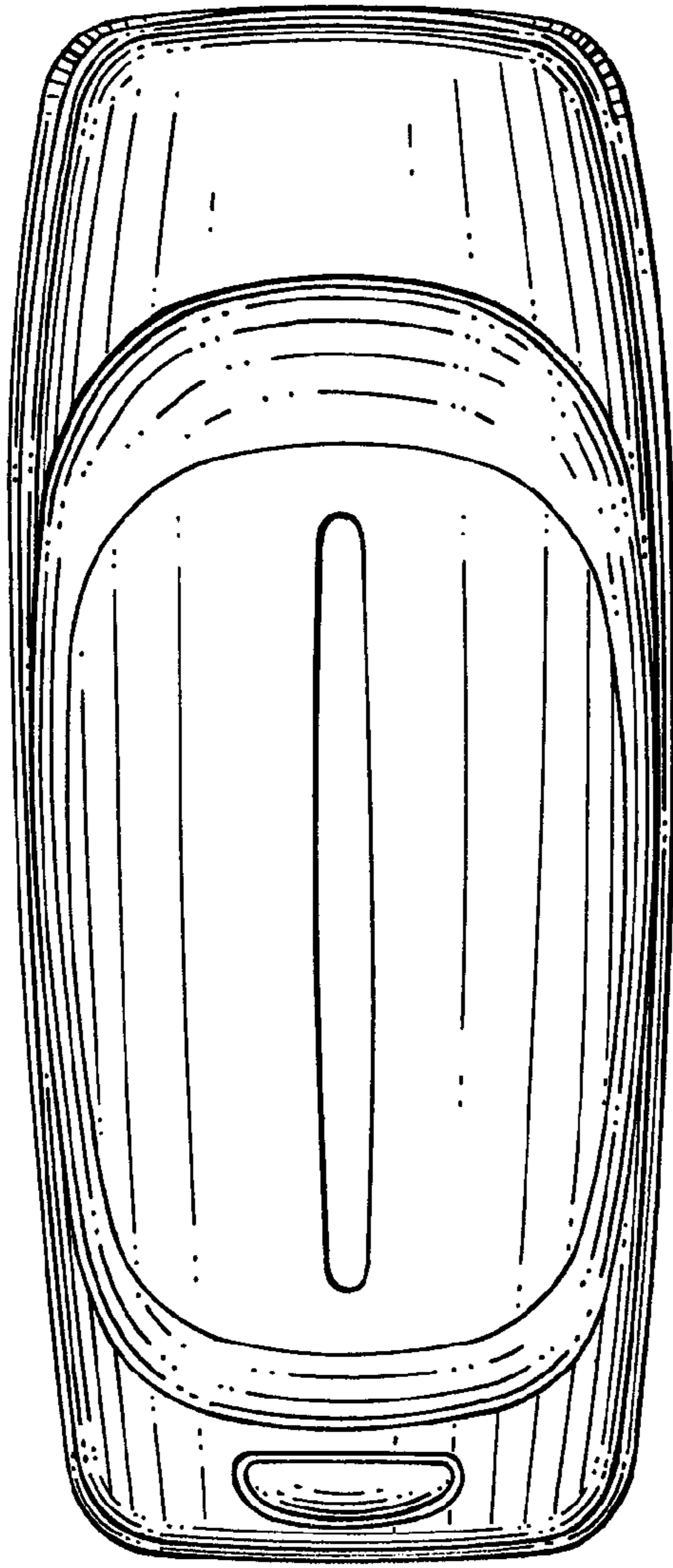
FIG. 1 is a perspective view of the housing for a telephone showing our new design;

FIG. 2 is a left side perspective view of the front and back cover for a telephone design of FIG. 1; and,

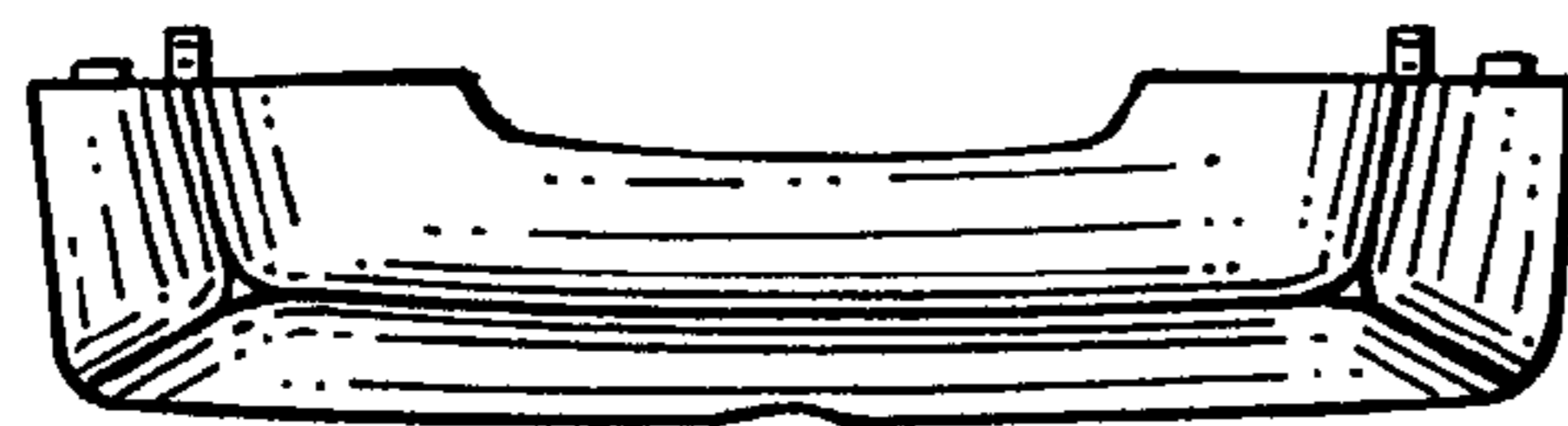
FIG. 3 is a right side perspective view of the front and back cover for a telephone design of FIG. 1.

**1 Claim, 11 Drawing Sheets**

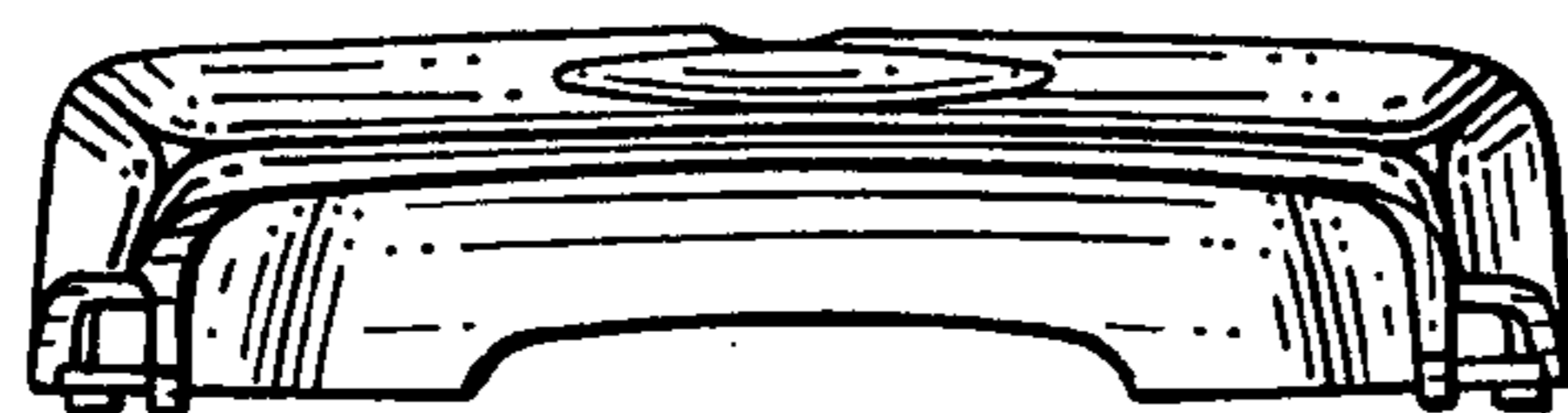




*FIG. 1*



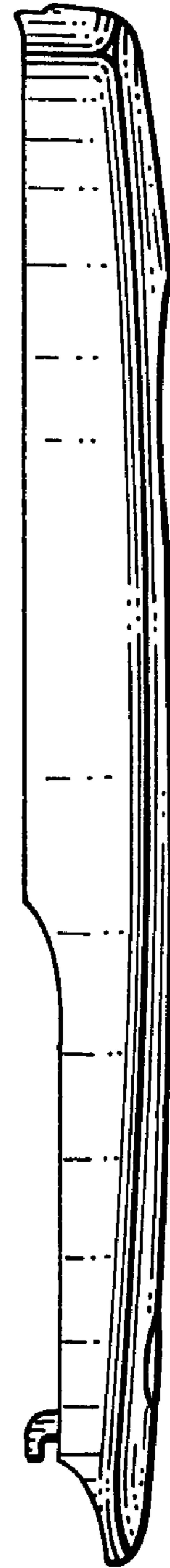
*FIG. 2*



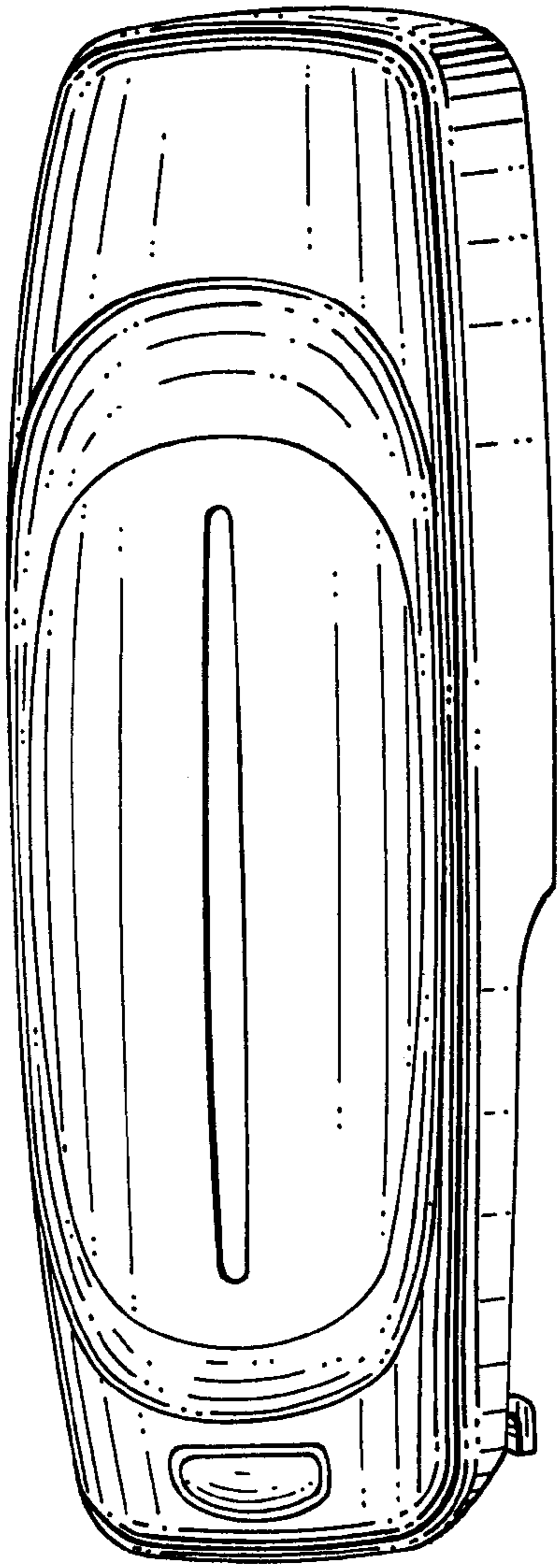
*FIG. 3*



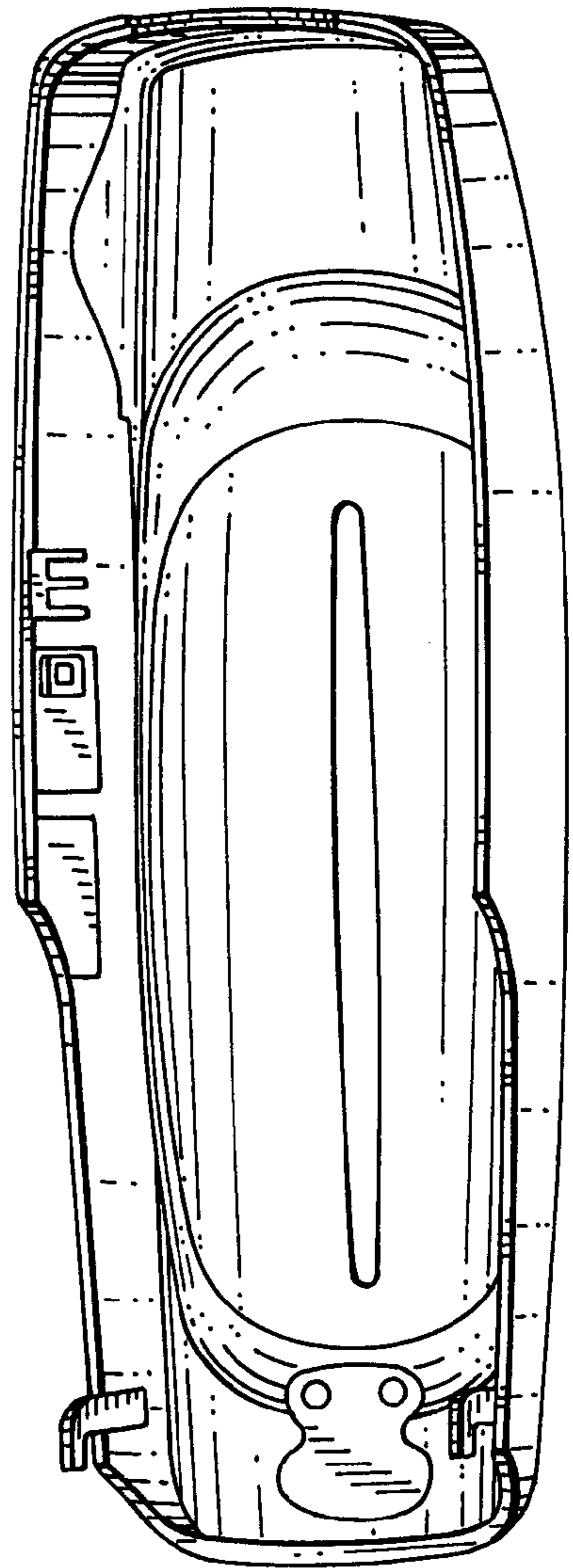
**FIG. 4**



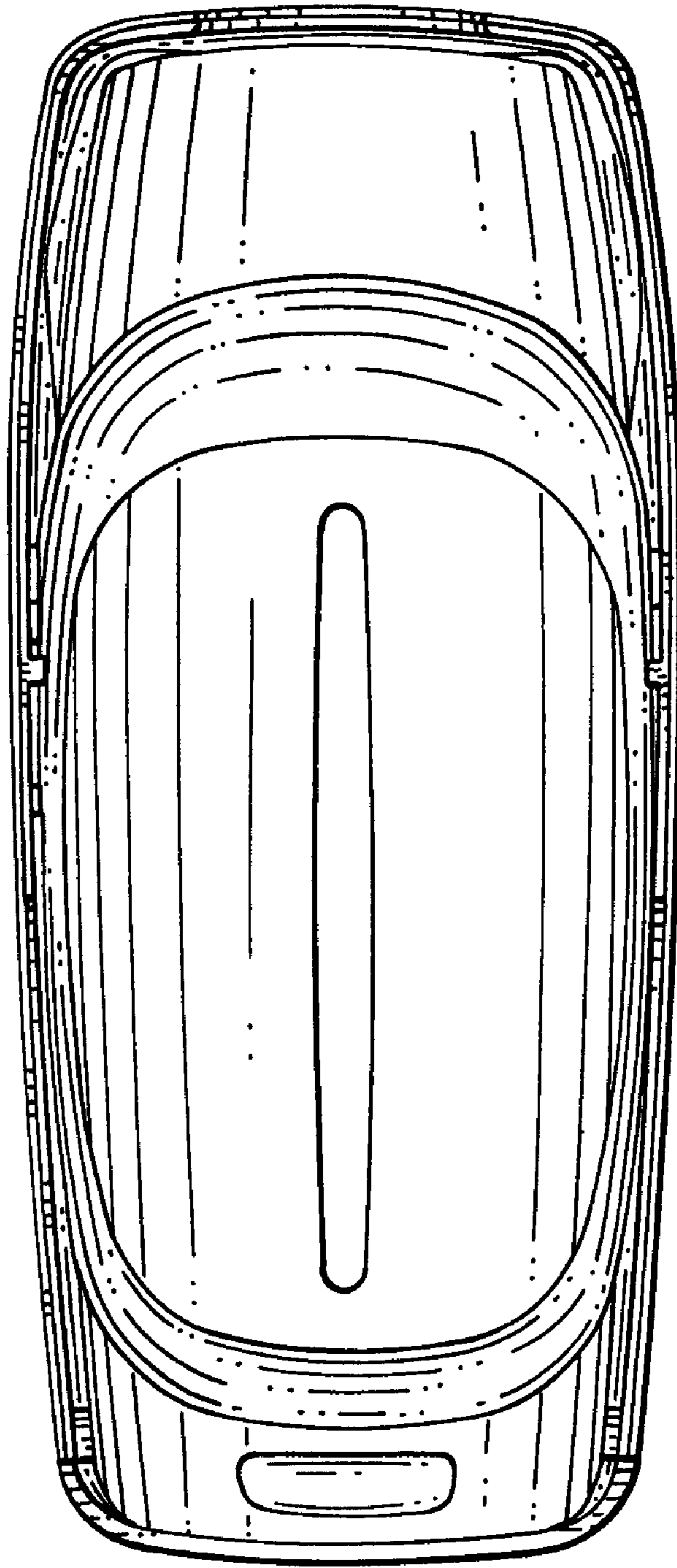
**FIG. 5**



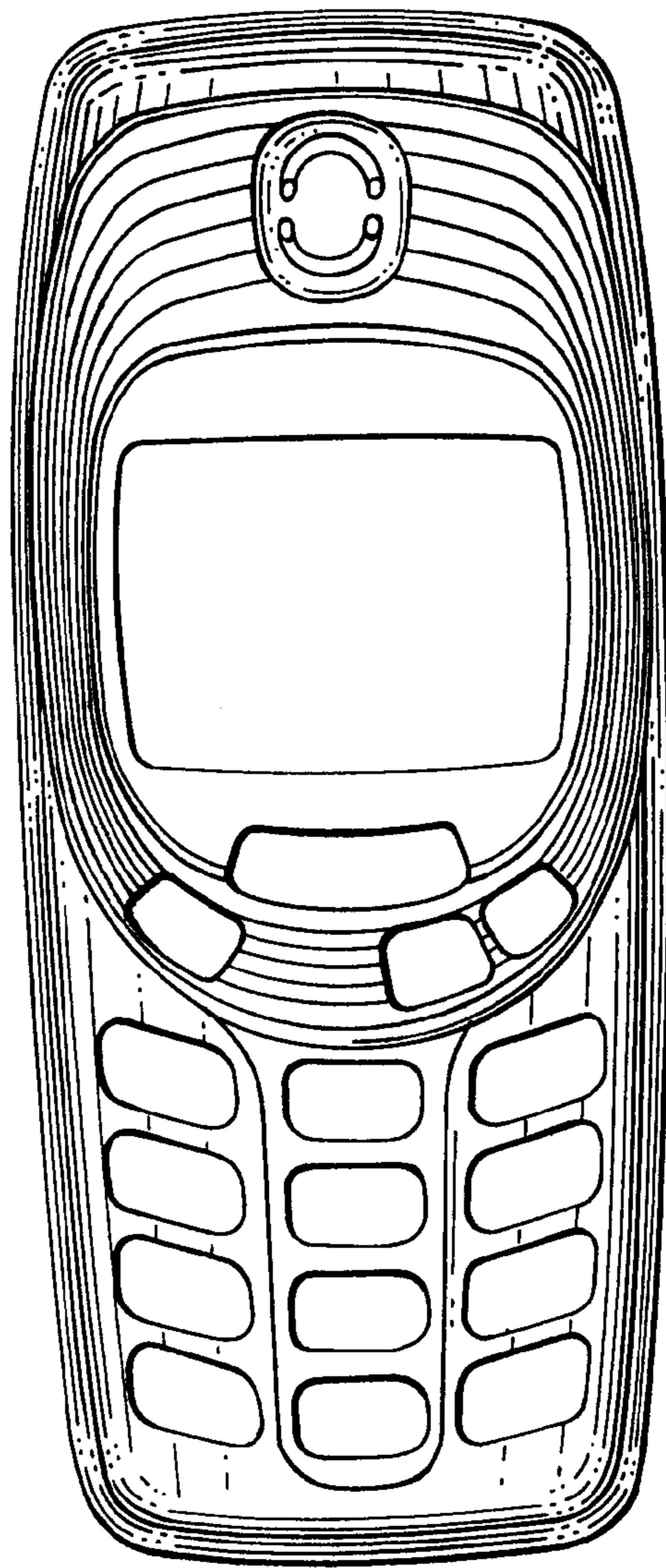
**FIG. 6**



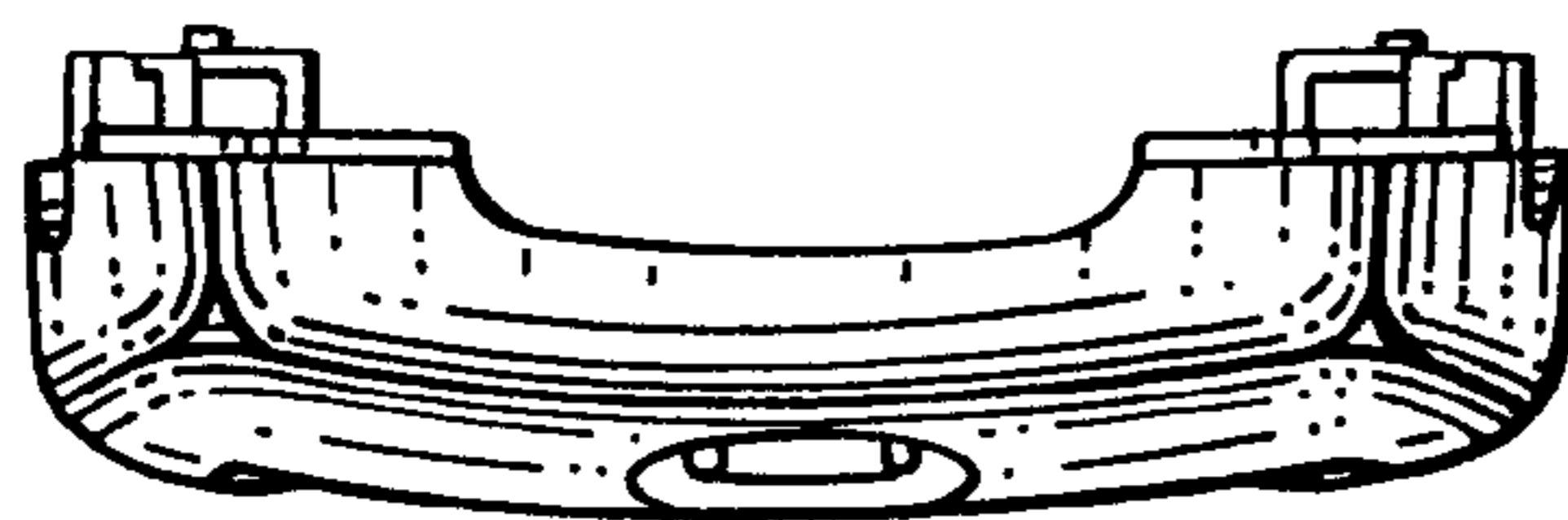
**FIG. 7**



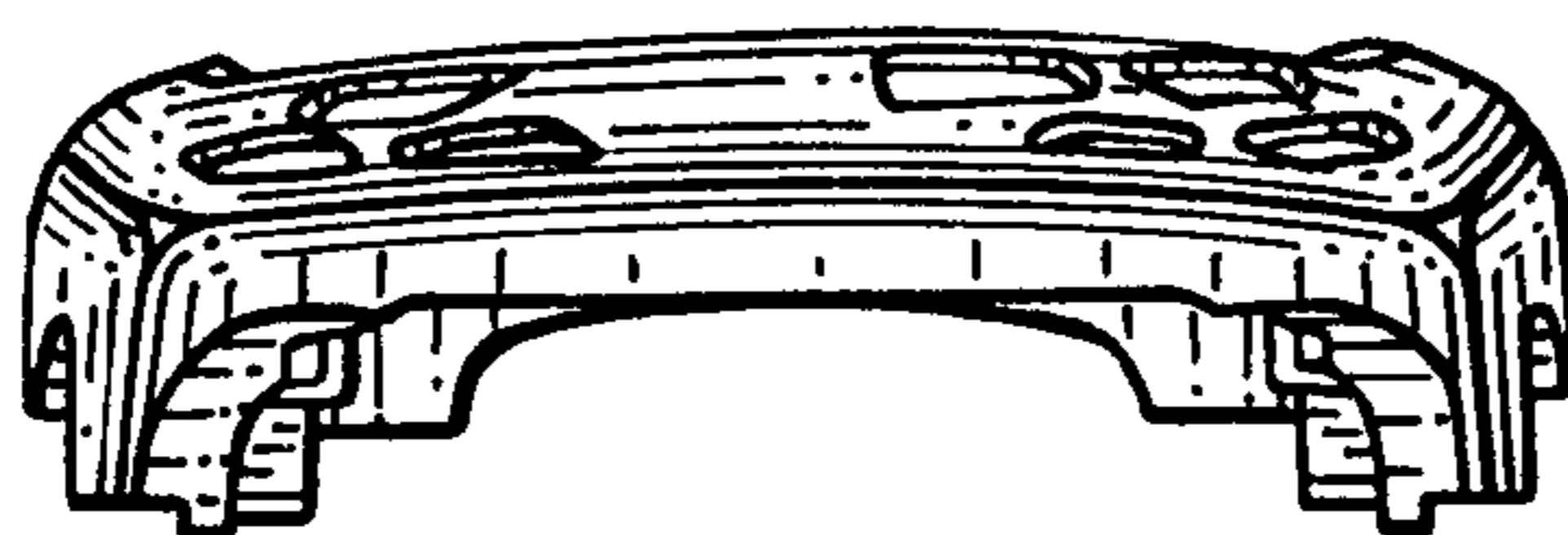
**FIG. 8**



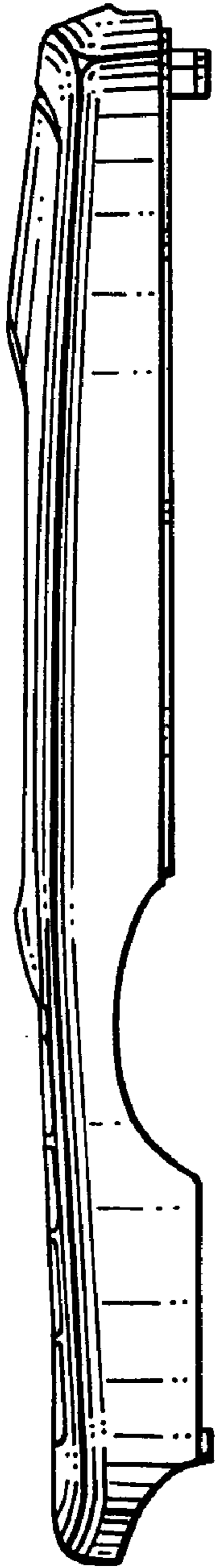
*FIG. 9*



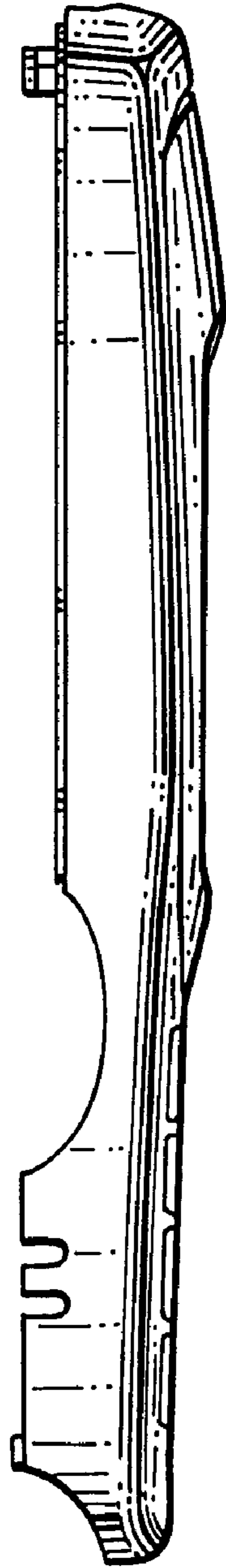
*FIG. 10*



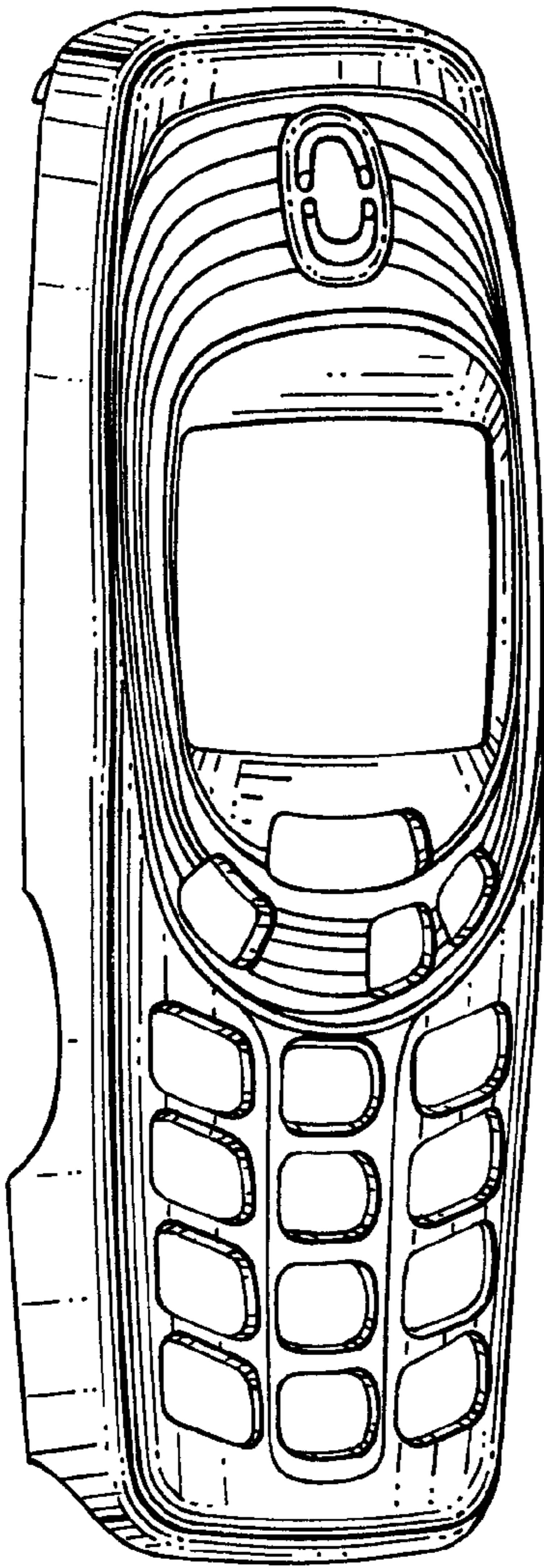
*FIG. 11*



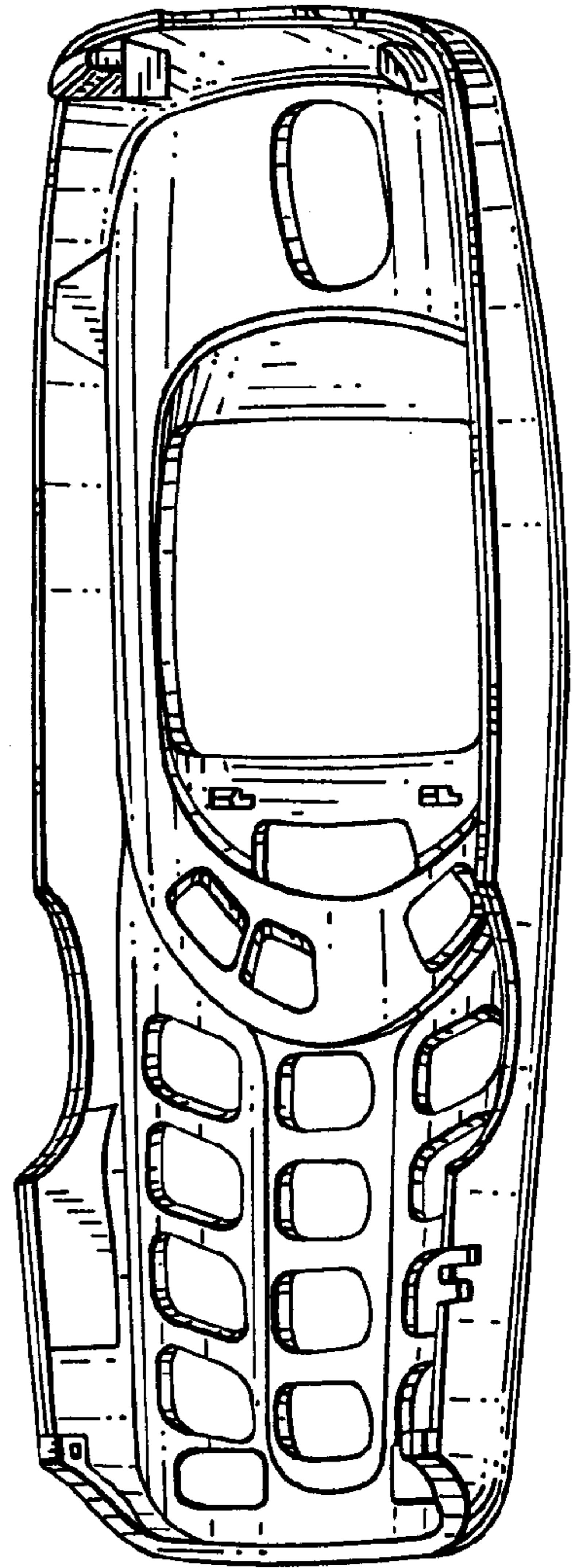
*FIG. 12*



*FIG. 13*

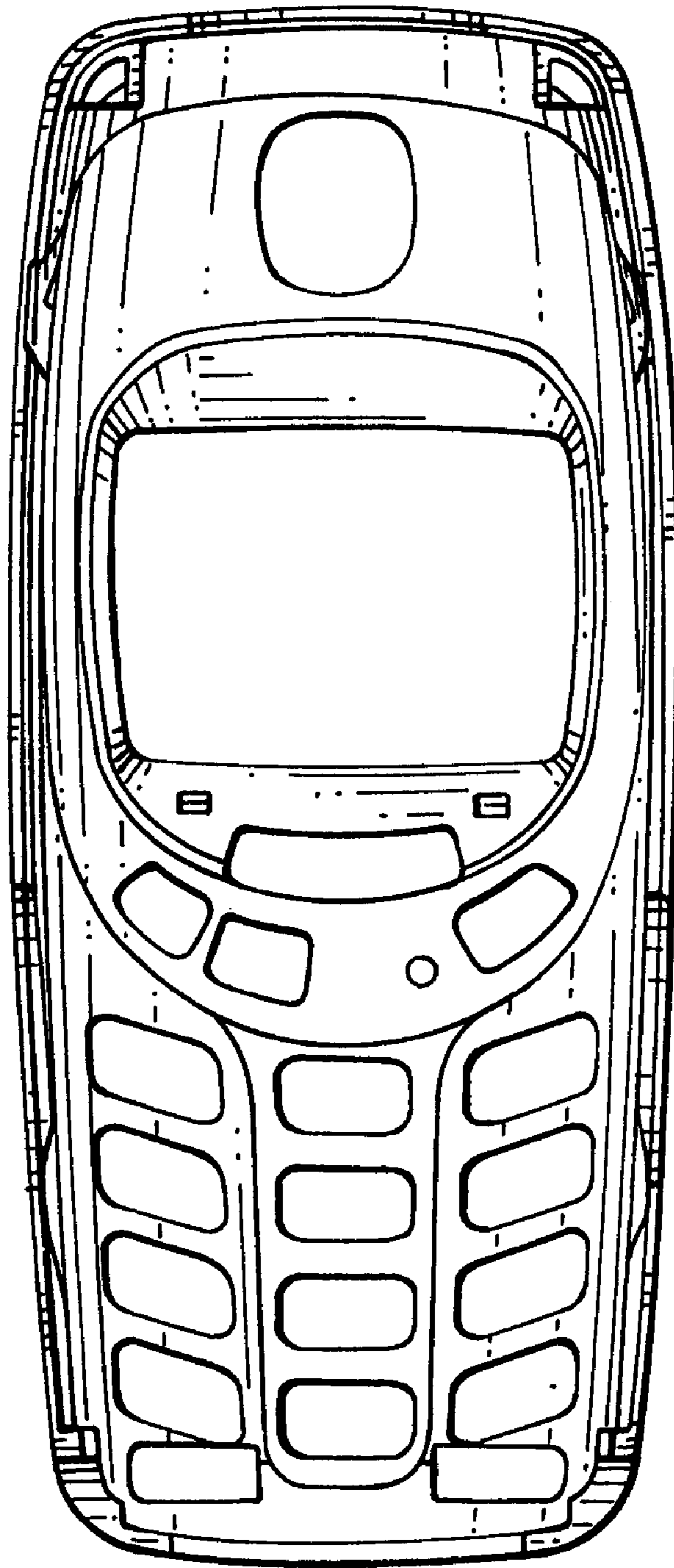


*FIG. 14*

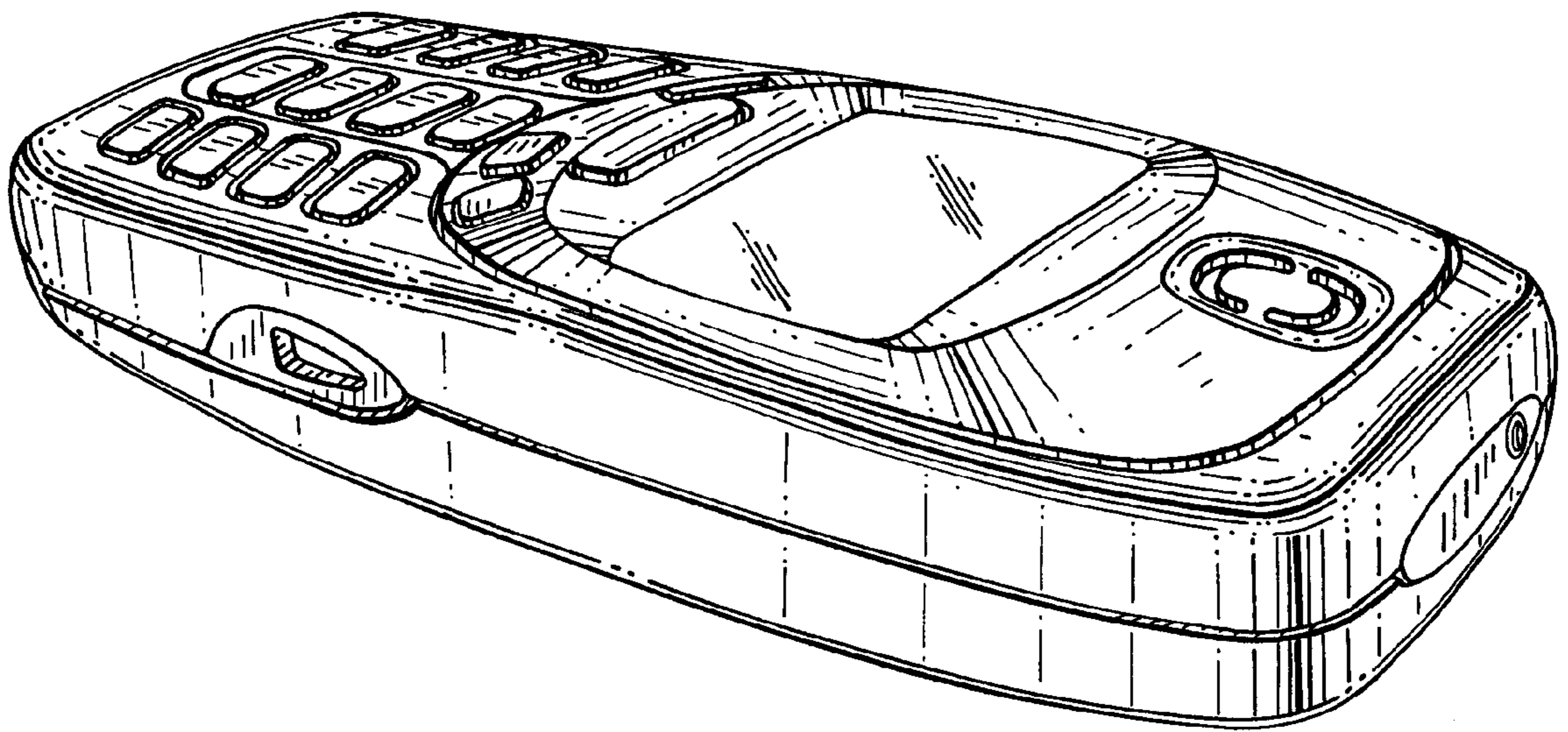


*FIG. 15*

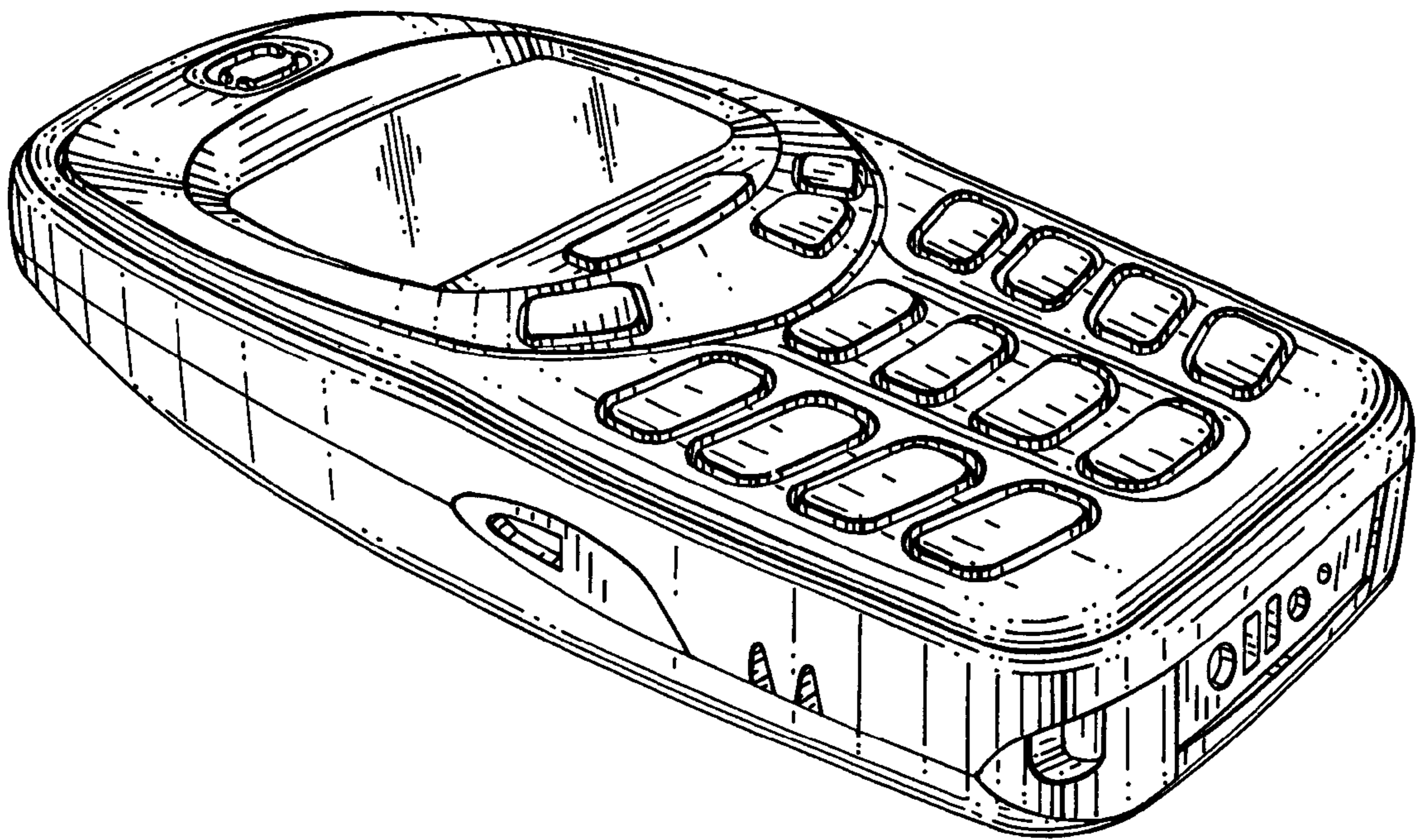




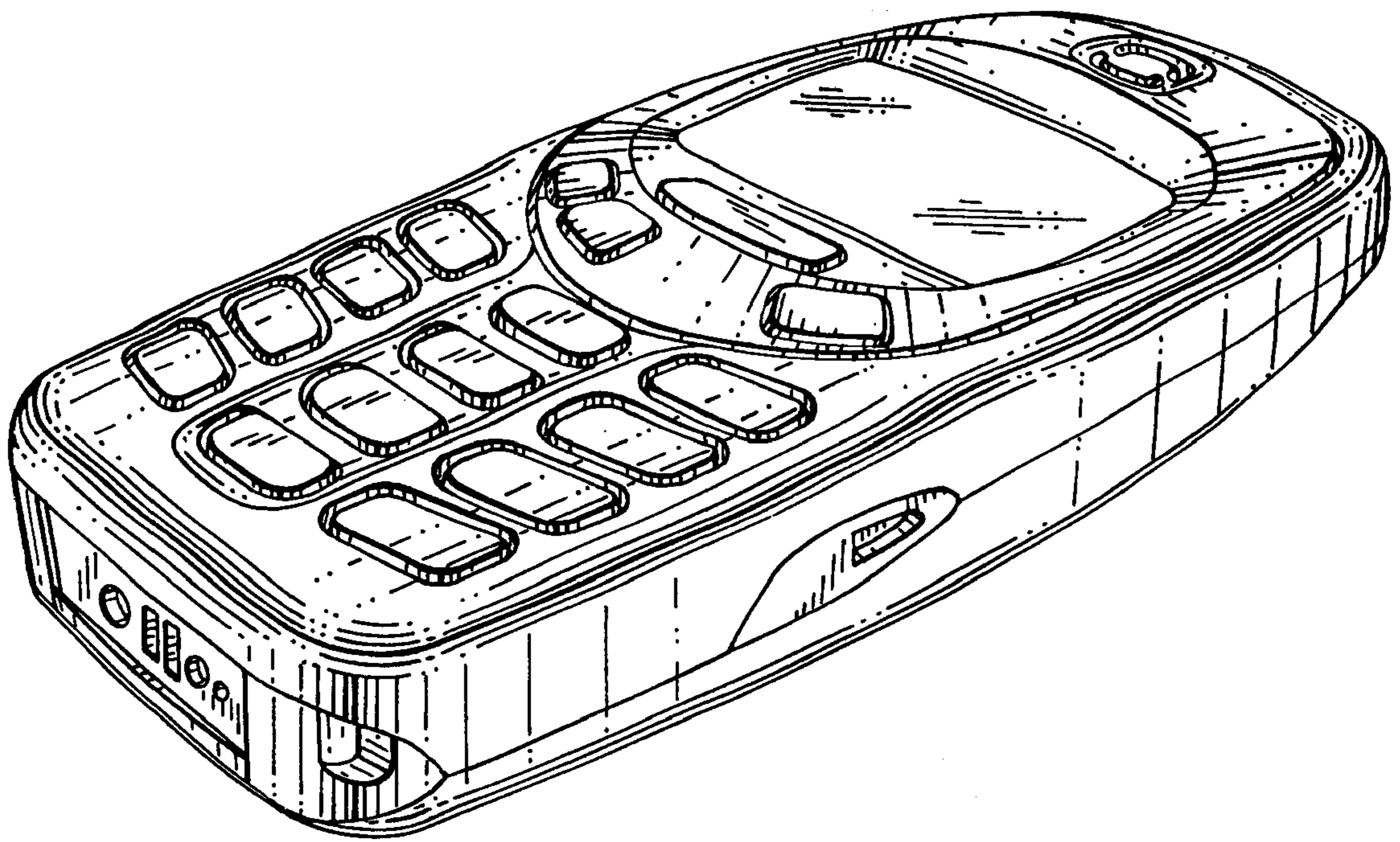
*FIG. 16*



*FIG 17*



*FIG. 18*



*FIG. 19*