



US00D473451S

(12) **United States Design Patent**  
**Goodman et al.**

(10) **Patent No.:** **US D473,451 S**

(45) **Date of Patent:** **\*\* Apr. 22, 2003**

(54) **WALL MOUNT HOOKS**

D455,947 S \* 4/2002 Goodman et al. .... D8/367

(75) Inventors: **Sheldon H. Goodman**, 30905 Stratford,  
Solon, OH (US) 44139; **Brian**  
**Stelmarski**, Mayfield Heights, OH (US)

\* cited by examiner

*Primary Examiner*—Pamela Burgess  
(74) *Attorney, Agent, or Firm*—Pearne & Gordon LLP

(73) Assignee: **Sheldon H. Goodman**, Solon, OH (US)

(57) **CLAIM**

(\*\*) Term: **14 Years**

The ornamental design for wall mount hooks, as shown and described.

(21) Appl. No.: **29/140,347**

(22) Filed: **Apr. 17, 2001**

(51) **LOC (7) Cl.** ..... **08-05**

(52) **U.S. Cl.** ..... **D8/367; D8/372; D8/370**

(58) **Field of Search** ..... D6/323; D8/372,  
D8/367, 370, 373; 248/301–304, 205.5,  
206.2, 214, 309, 339, 322, 231.81, 399,  
218.1, 497; 211/106, 106.01, 87.01, 181.1,  
119

**DESCRIPTION**

FIG. 1 is a front, side and top perspective view of a hook showing our new design;  
FIG. 2 is a front elevational view thereof;  
FIG. 3 is a side elevational view thereof;  
FIG. 4 is a rear elevational view thereof;  
FIG. 5 is a top plan view thereof;  
FIG. 6 is a bottom plan view thereof;  
FIG. 7 is front, side and top perspective view of a second embodiment of a hook in accordance with our new design, showing a two hook style;  
FIG. 8 is a front elevational view thereof;  
FIG. 9 is a side elevational view thereof;  
FIG. 10 is a rear elevational view thereof;  
FIG. 11 is a top plan view thereof; and,  
FIG. 12 is a bottom plan view thereof.

The broken-line disclosure of elements in the views is for illustrative purposes only and forms no part of the claimed design.

(56) **References Cited**

**U.S. PATENT DOCUMENTS**

D343,112 S	*	1/1994	Corbin	.....	D8/367
D401,840 S		12/1998	Goodman et al.	.....	D8/367
D408,723 S		4/1999	Goodman et al.	.....	D8/367
D409,398 S	*	5/1999	Sweetman	.....	D6/323
D409,399 S	*	5/1999	Robinson	.....	D6/323
D431,451 S	*	10/2000	Kuo	.....	D8/367
D435,786 S		1/2001	Goodman et al.	.....	D8/372
D435,971 S	*	1/2001	Solowiej	.....	D6/323
D436,839 S		1/2001	Goodman et al.	.....	D8/372

**1 Claim, 4 Drawing Sheets**

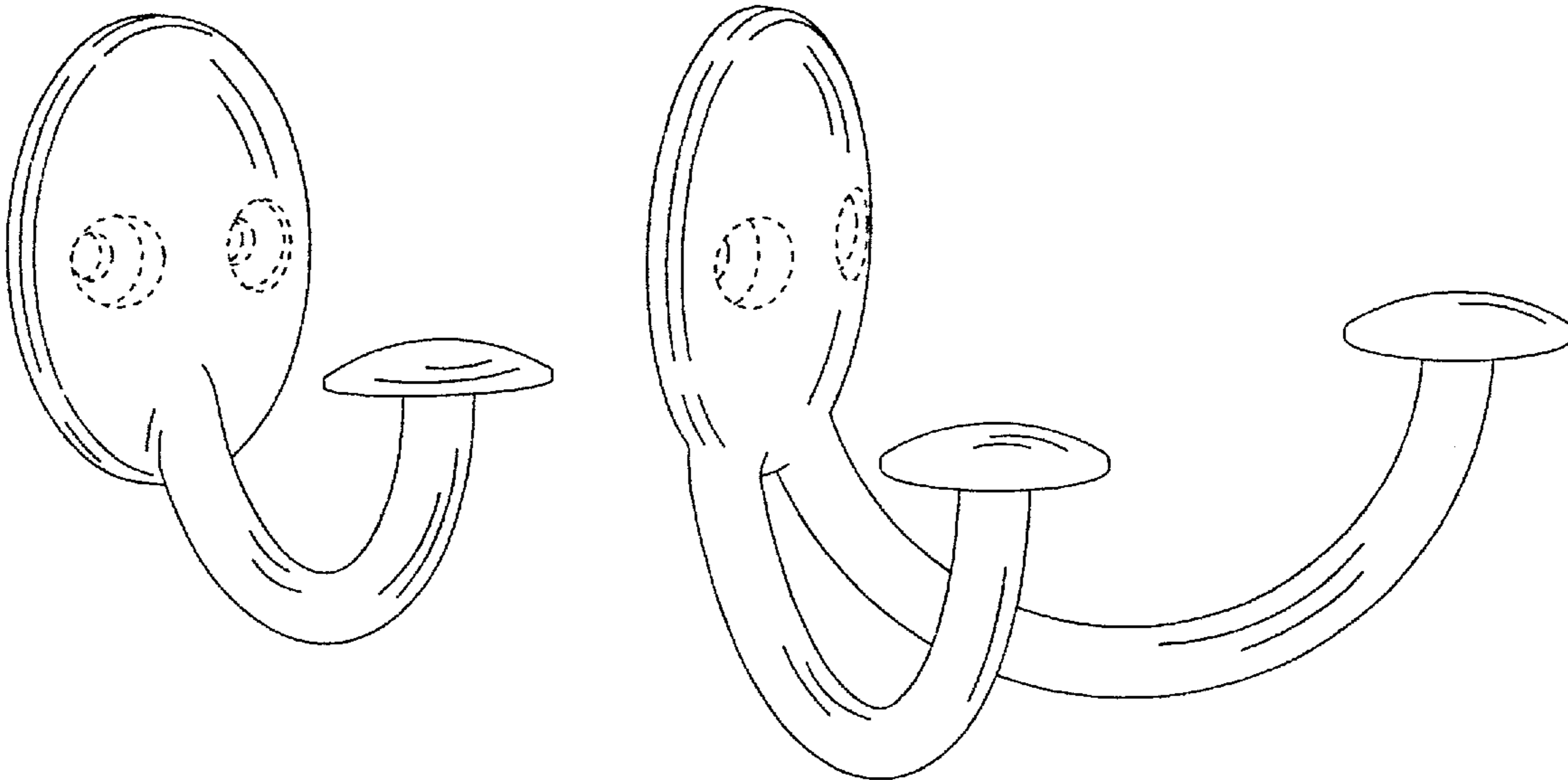

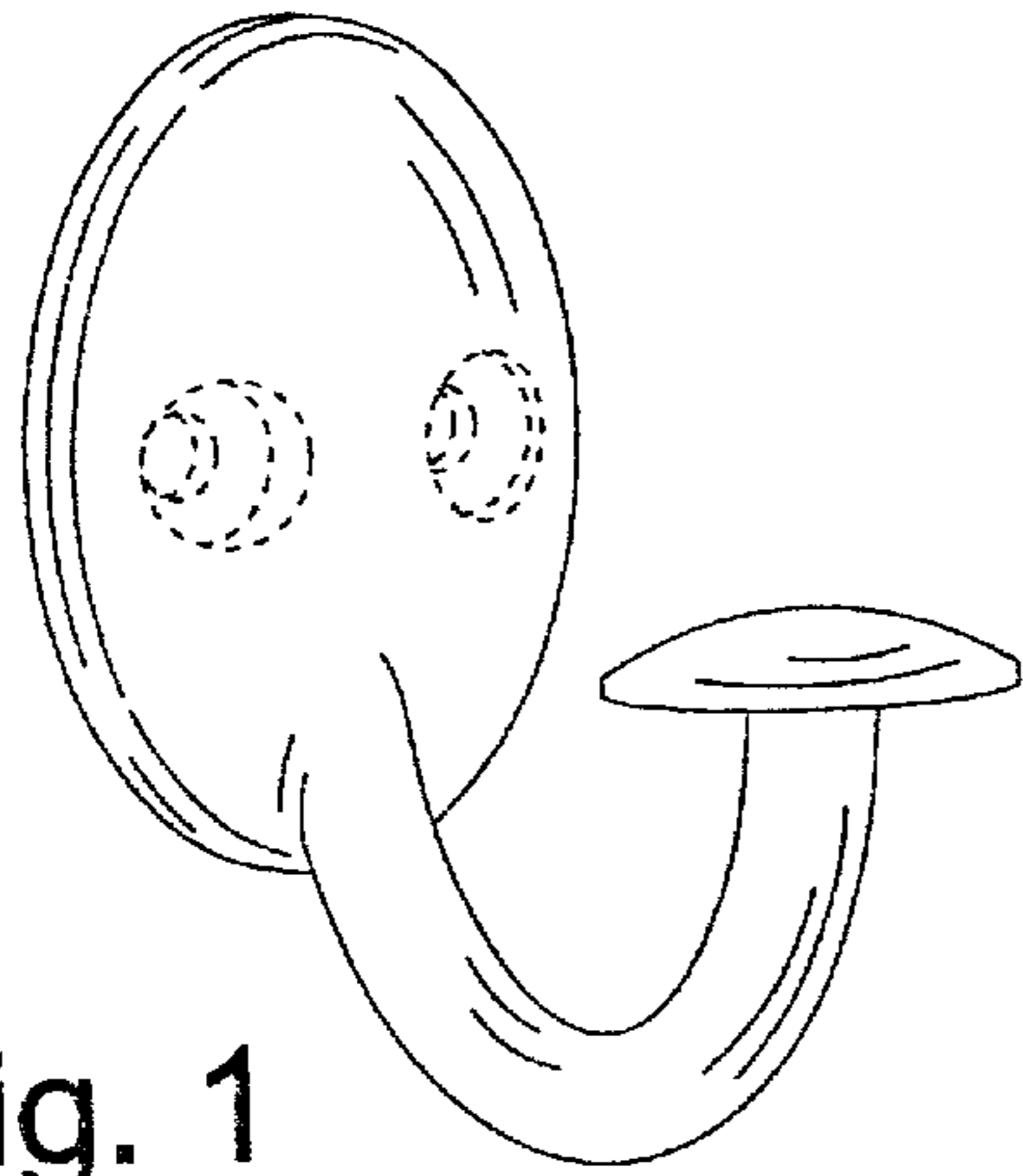

Fig. 1

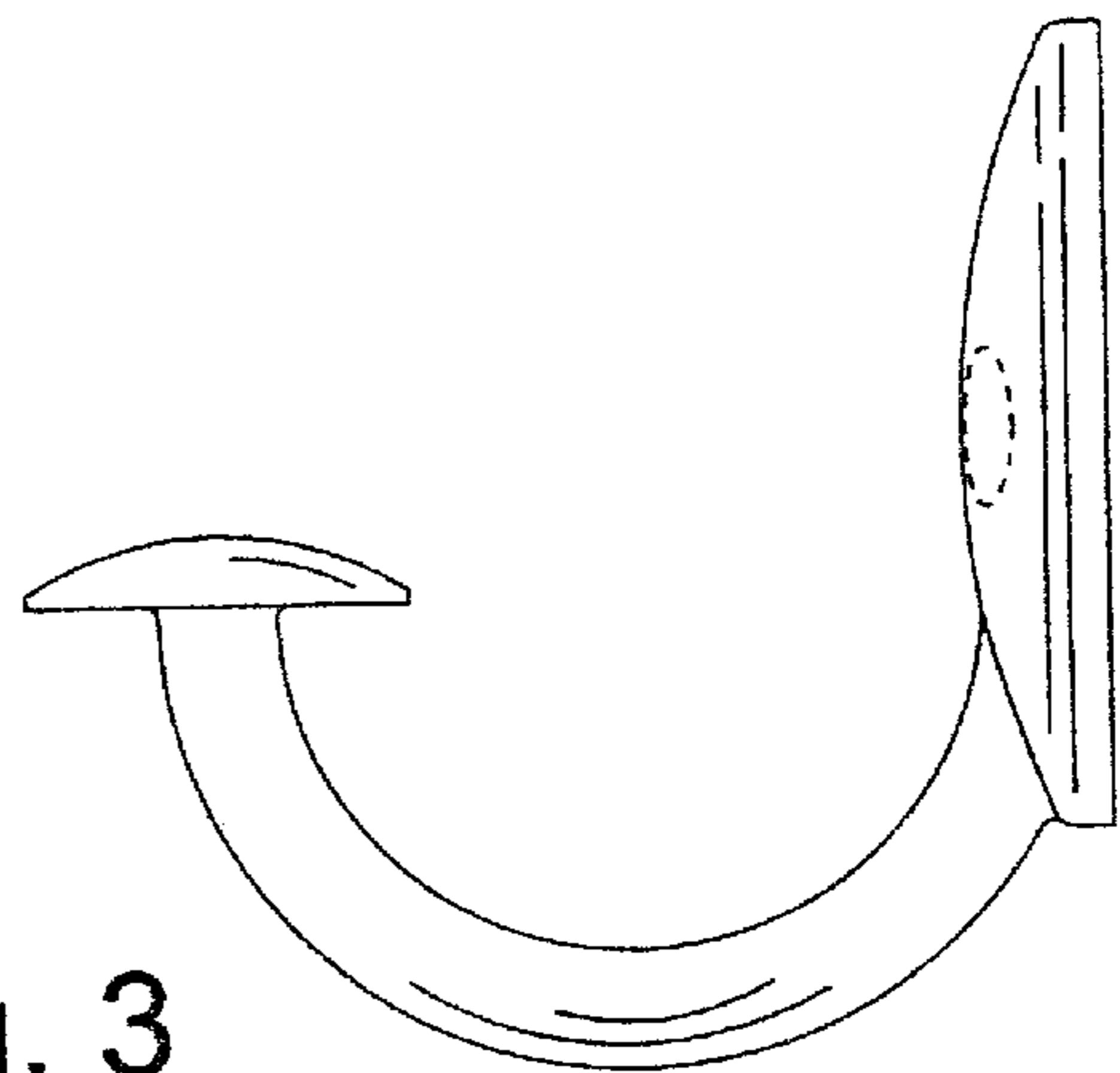

Fig. 3

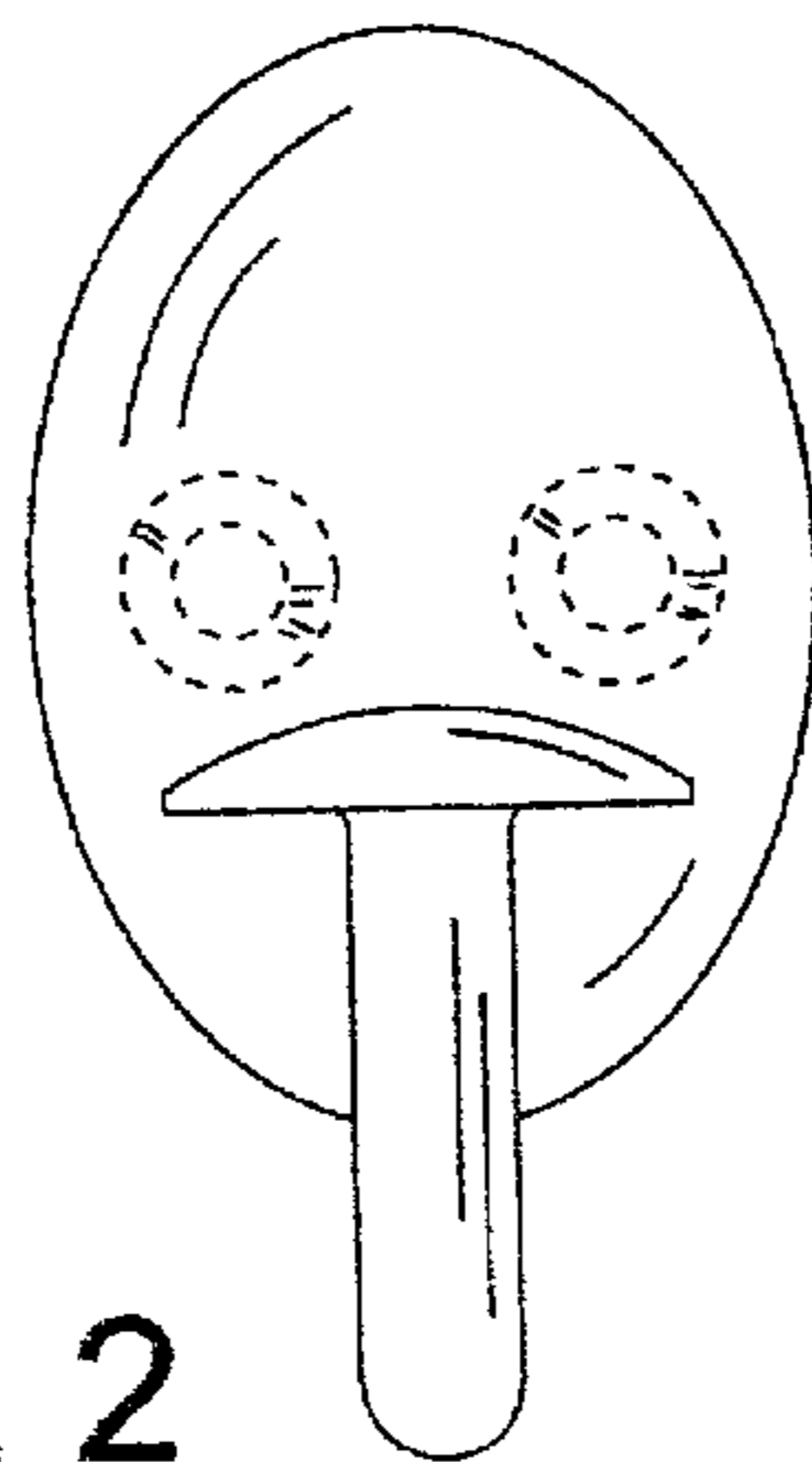

Fig. 2

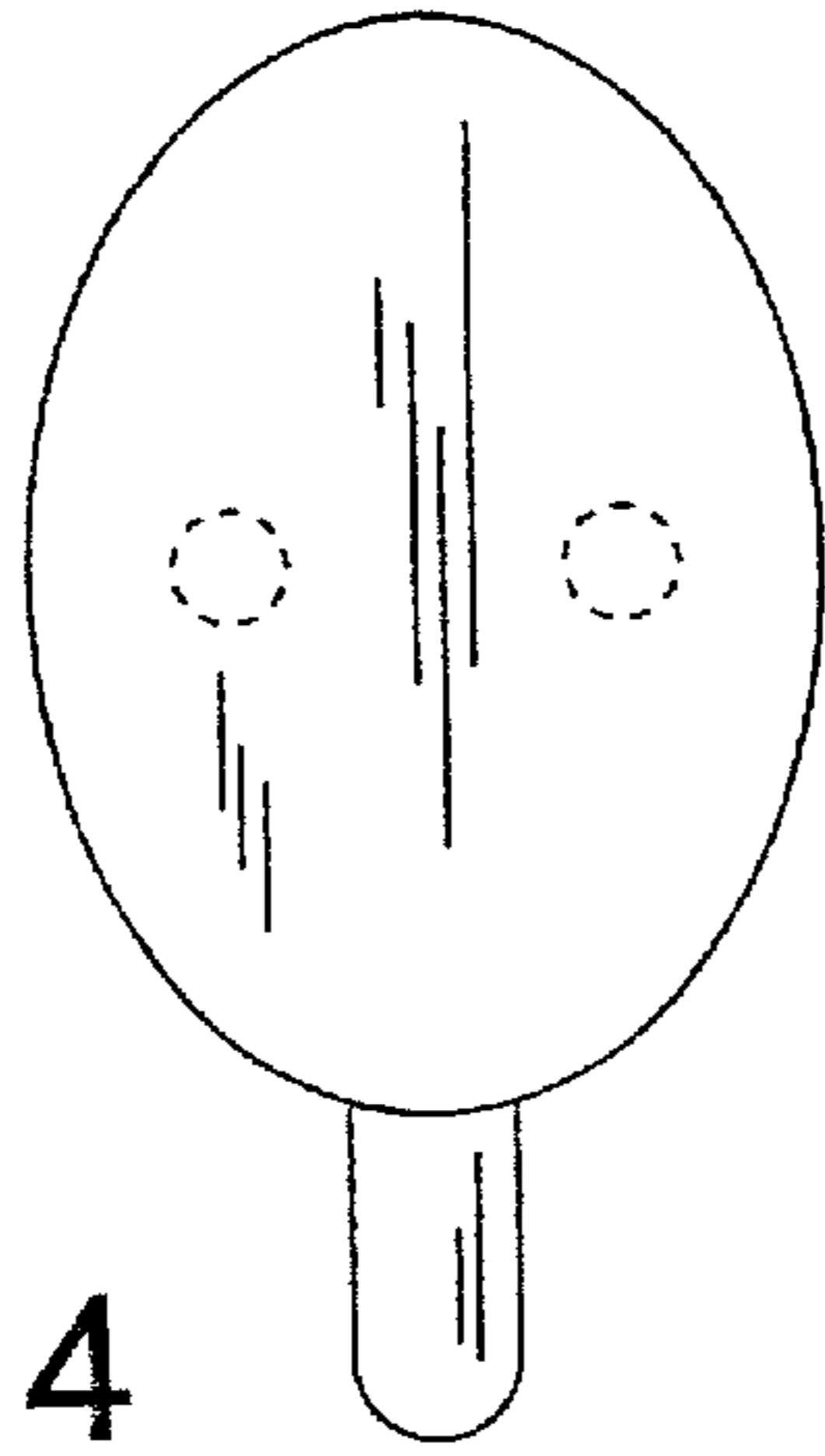

Fig. 4

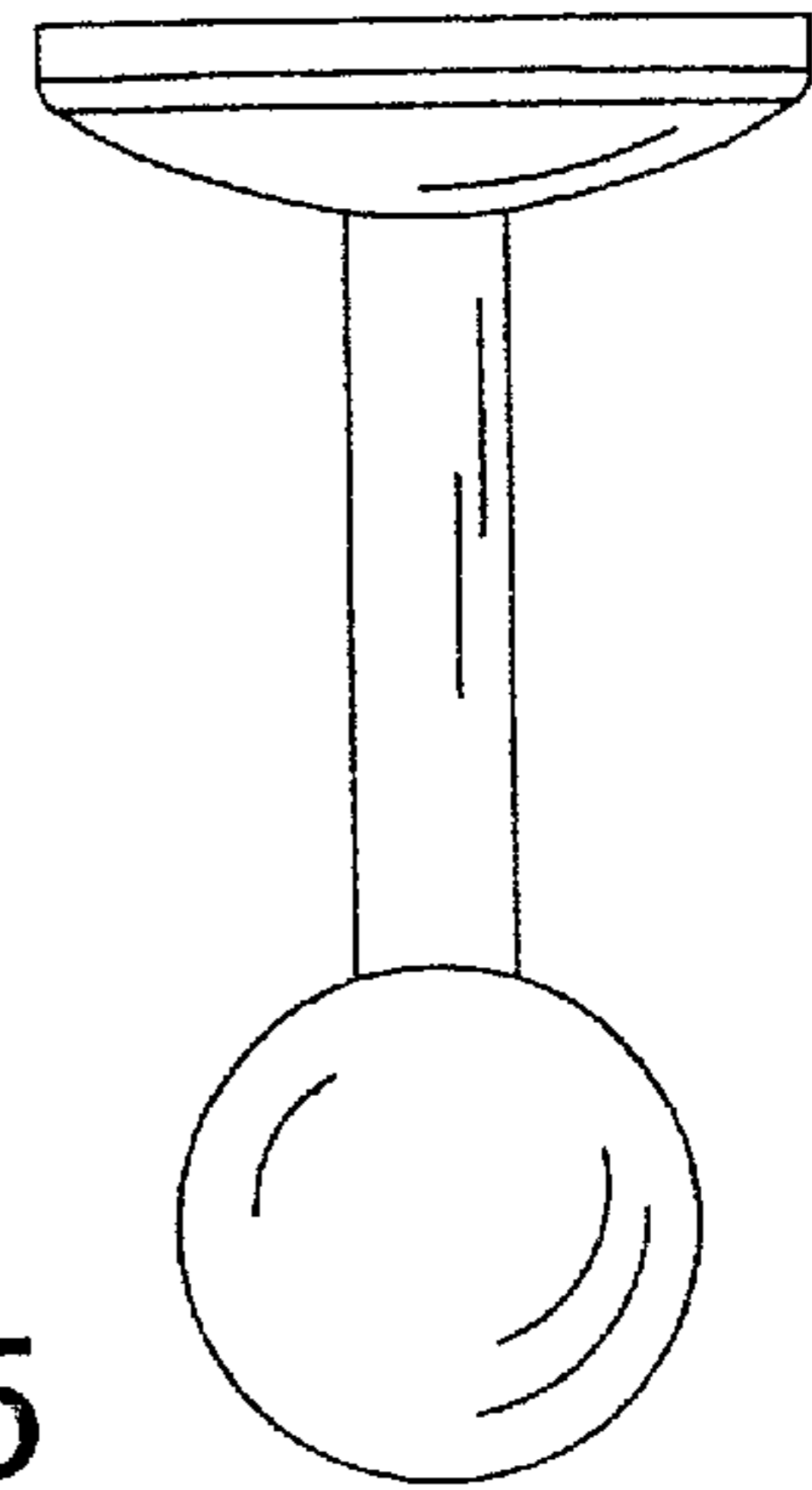

Fig. 5

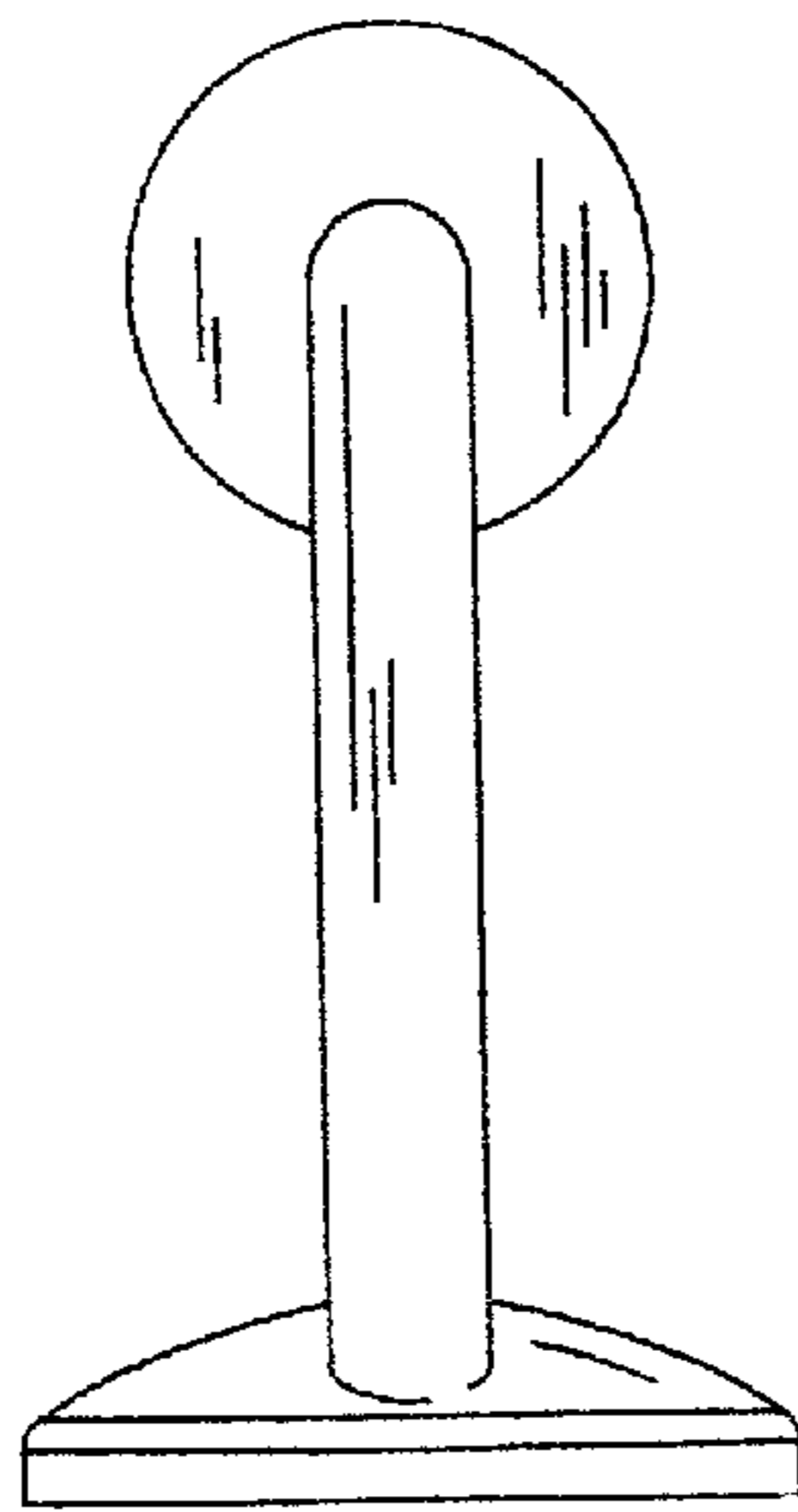

Fig. 6

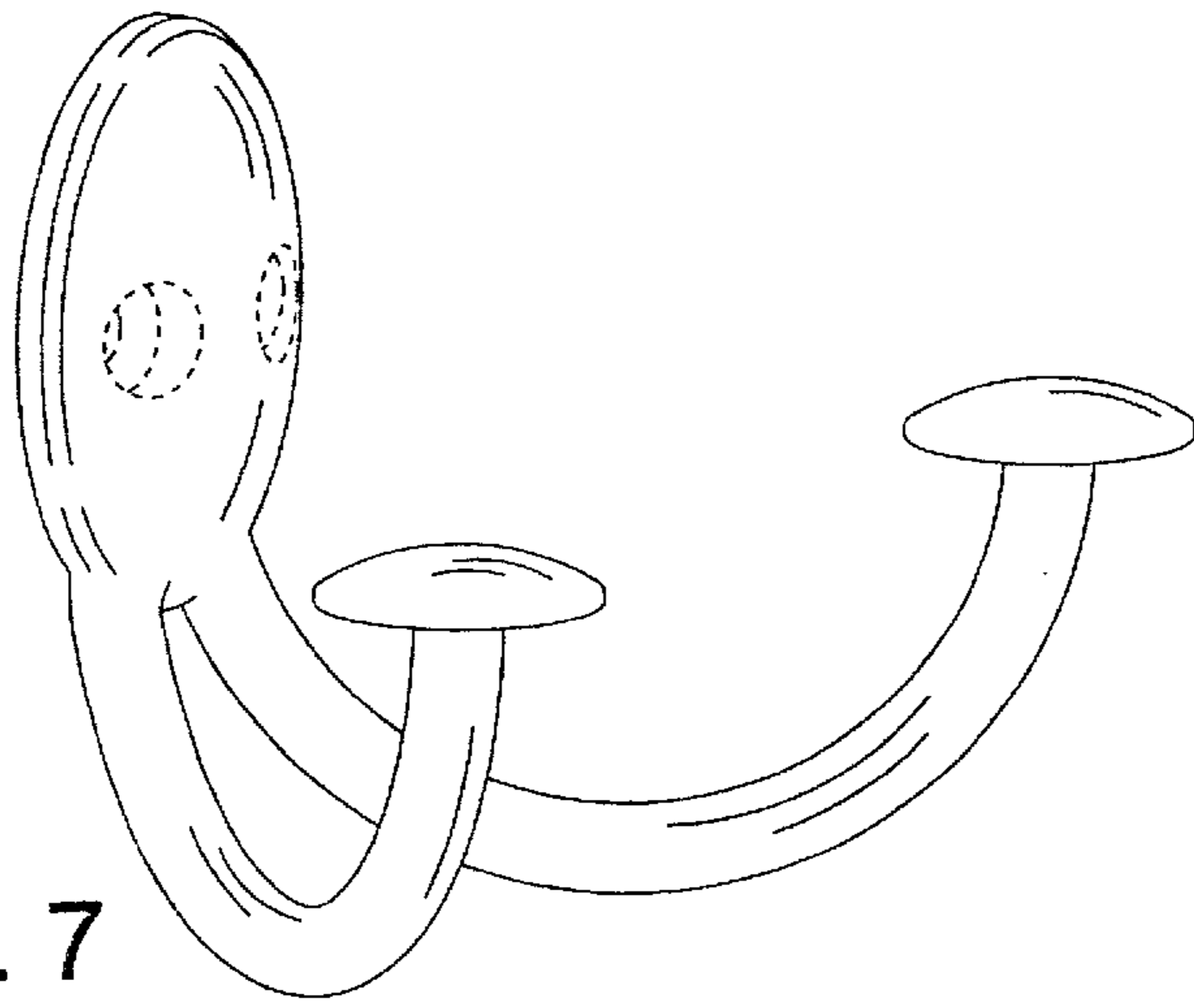

Fig. 7

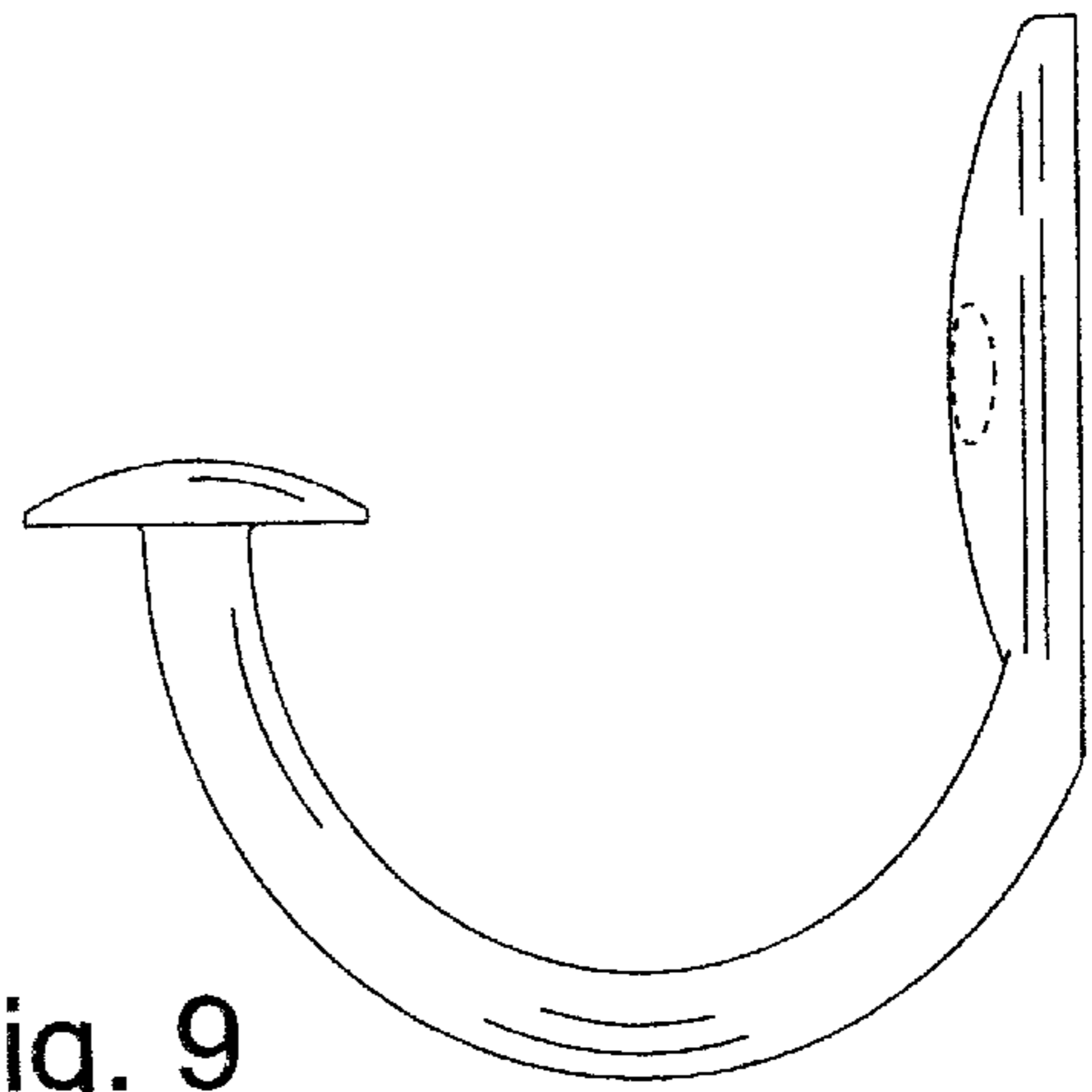

Fig. 9

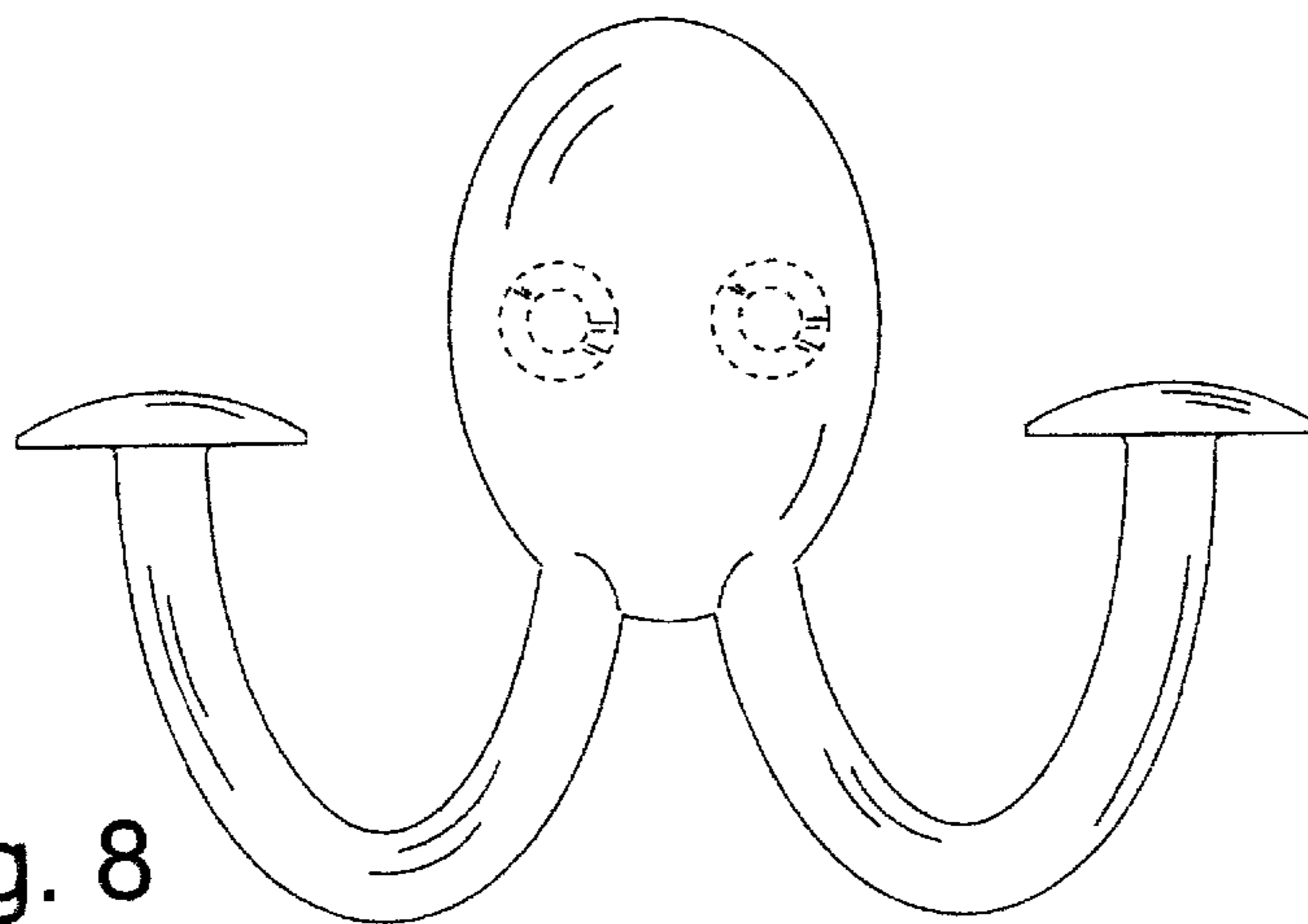

Fig. 8

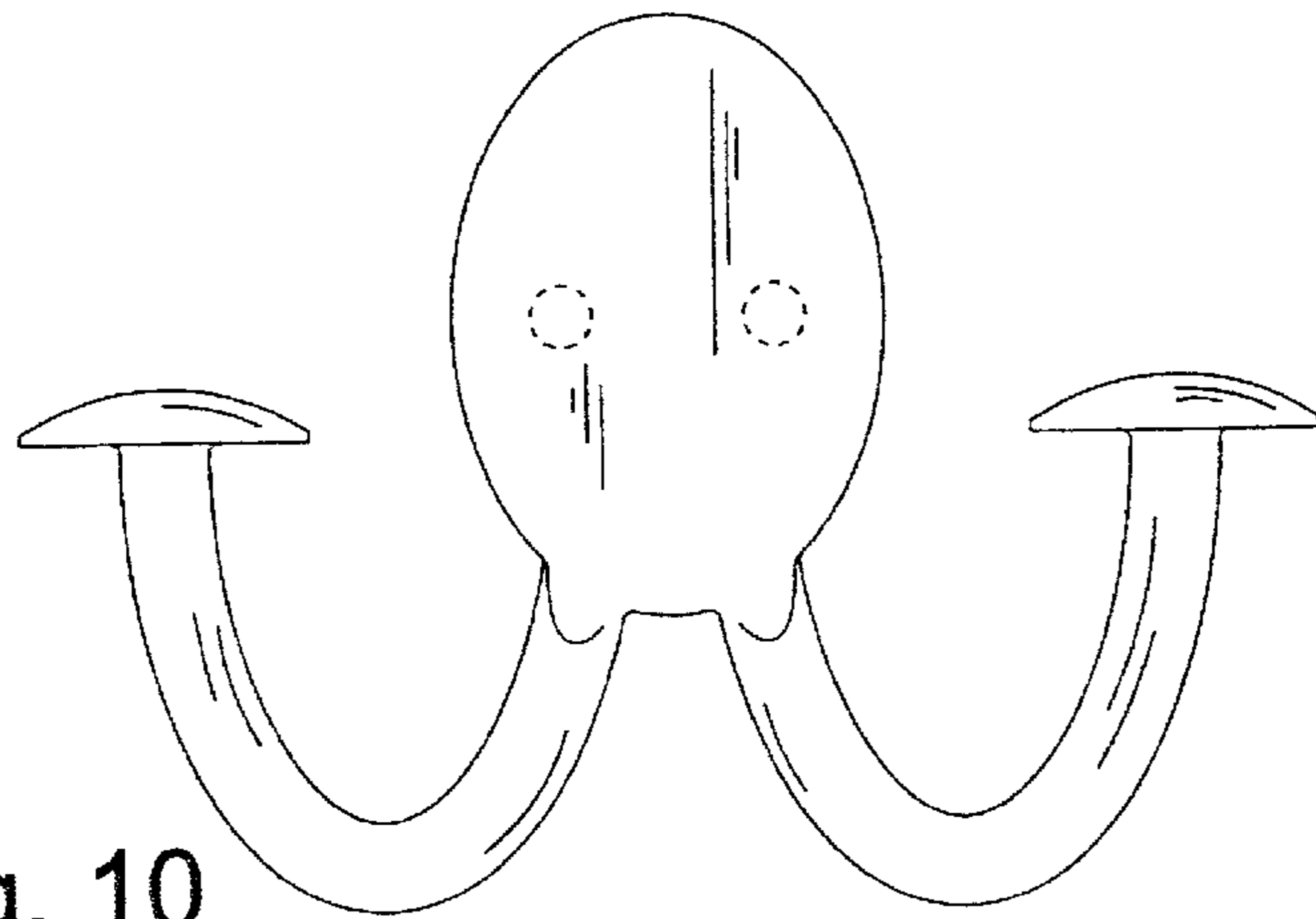

Fig. 10

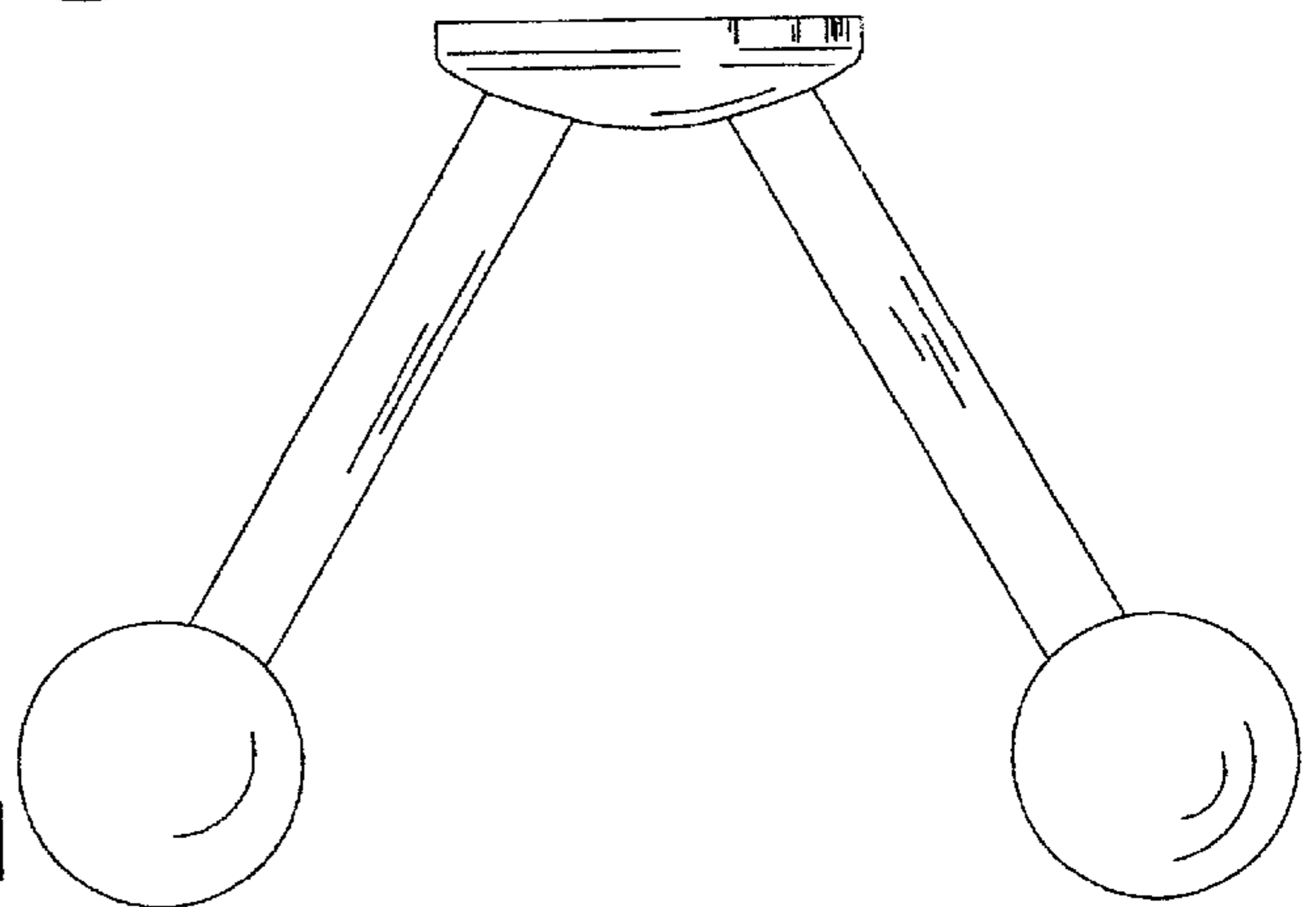

Fig. 11

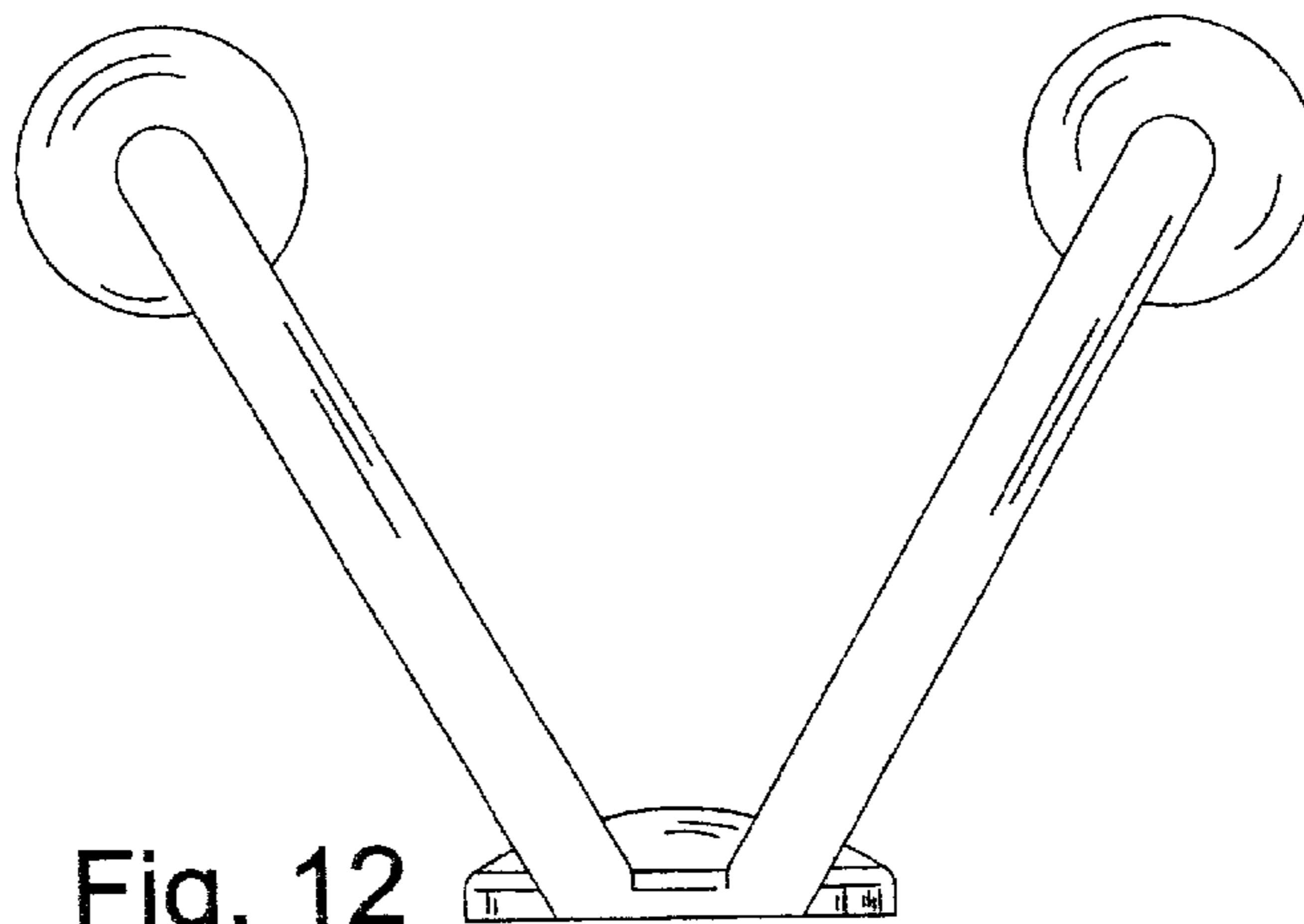

Fig. 12