



US00D473420S

(12) **United States Design Patent**  
**Lo et al.**

(10) **Patent No.: US D473,420 S**

(45) **Date of Patent: \*\* Apr. 22, 2003**

(54) **FOOD MIXER**

(76) Inventors: **Yi M Lo**, 19 Hemlock Cir., Cranford, NJ (US) 07016; **Chun K Lee**, 3 Turner La., Towaco, NJ (US) 07082

(\*\*) Term: **14 Years**

(21) Appl. No.: **29/166,114**

(22) Filed: **Aug. 22, 2002**

(51) **LOC (7) Cl. .... 31-00**

(52) **U.S. Cl. .... D7/376**

(58) **Field of Search ..... D7/376-386; D15/82; 366/64-67, 143, 314, 601, 197-201, 219-221, 241-251, 341**

(56) **References Cited**

**U.S. PATENT DOCUMENTS**

- D285,404 S 9/1986 Wang
- D294,448 S \* 3/1988 Otto ..... D7/368
- D366,182 S \* 1/1996 Hsieh ..... D7/376

- D384,548 S \* 10/1997 Hsieh ..... D7/376
- D388,447 S \* 12/1997 Otto ..... D15/147
- D414,785 S \* 10/1999 Norris ..... D15/82

\* cited by examiner

*Primary Examiner*—Caron D. Veynar  
(74) *Attorney, Agent, or Firm*—Lin & Li

(57) **CLAIM**

The ornamental design for a food mixer, as shown and described.

**DESCRIPTION**

FIG. 1 is a perspective view of a food mixer showing our new design;  
FIG. 2 is a front elevational view thereof, the back elevational view being a mirror image thereof;  
FIG. 3 is a left side elevational view thereof;  
FIG. 4 is a right side elevational view thereof,  
FIG. 5 is a top plan view thereof; and,  
FIG. 6 is a bottom plan view thereof.

**1 Claim, 5 Drawing Sheets**

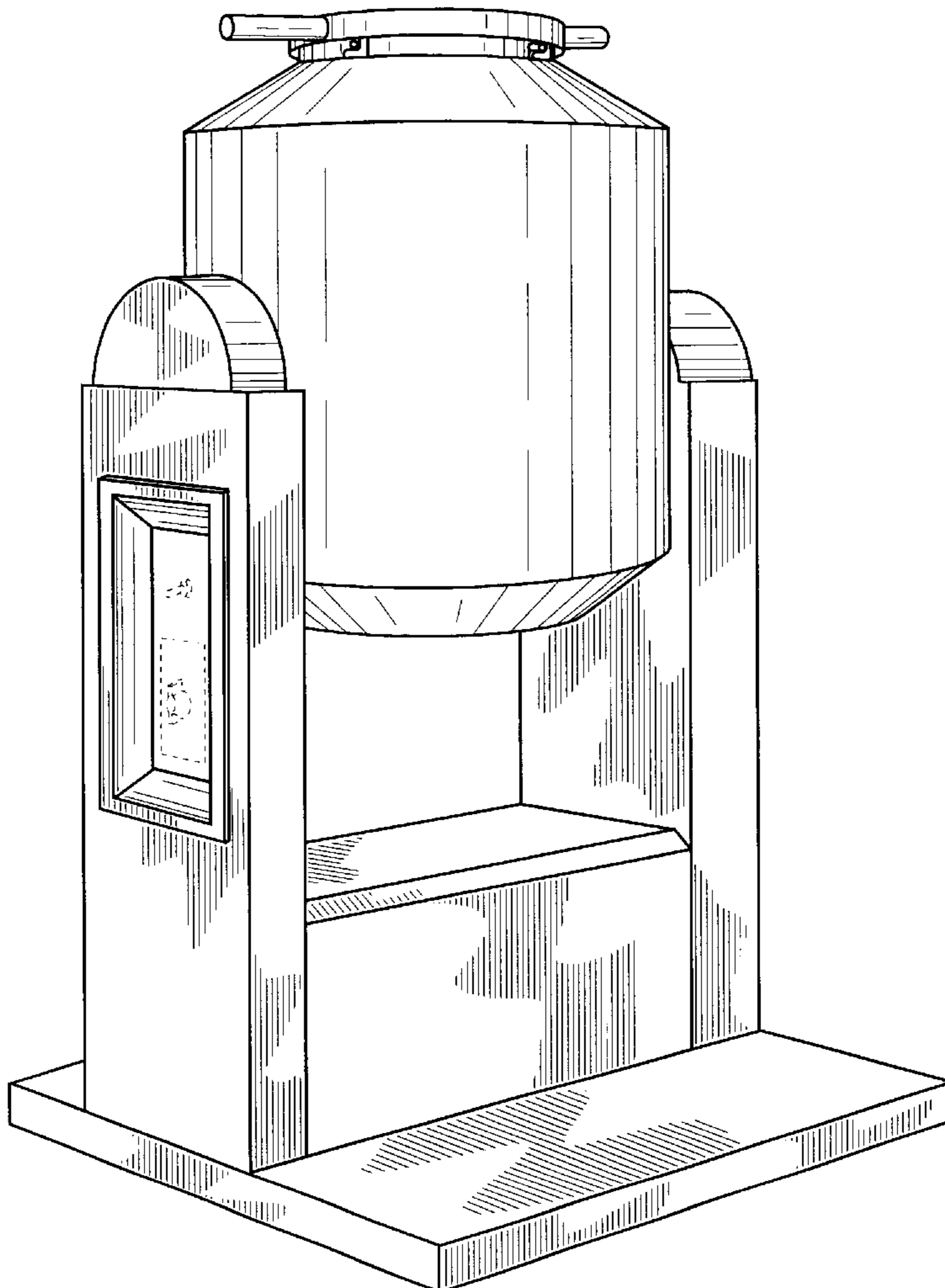

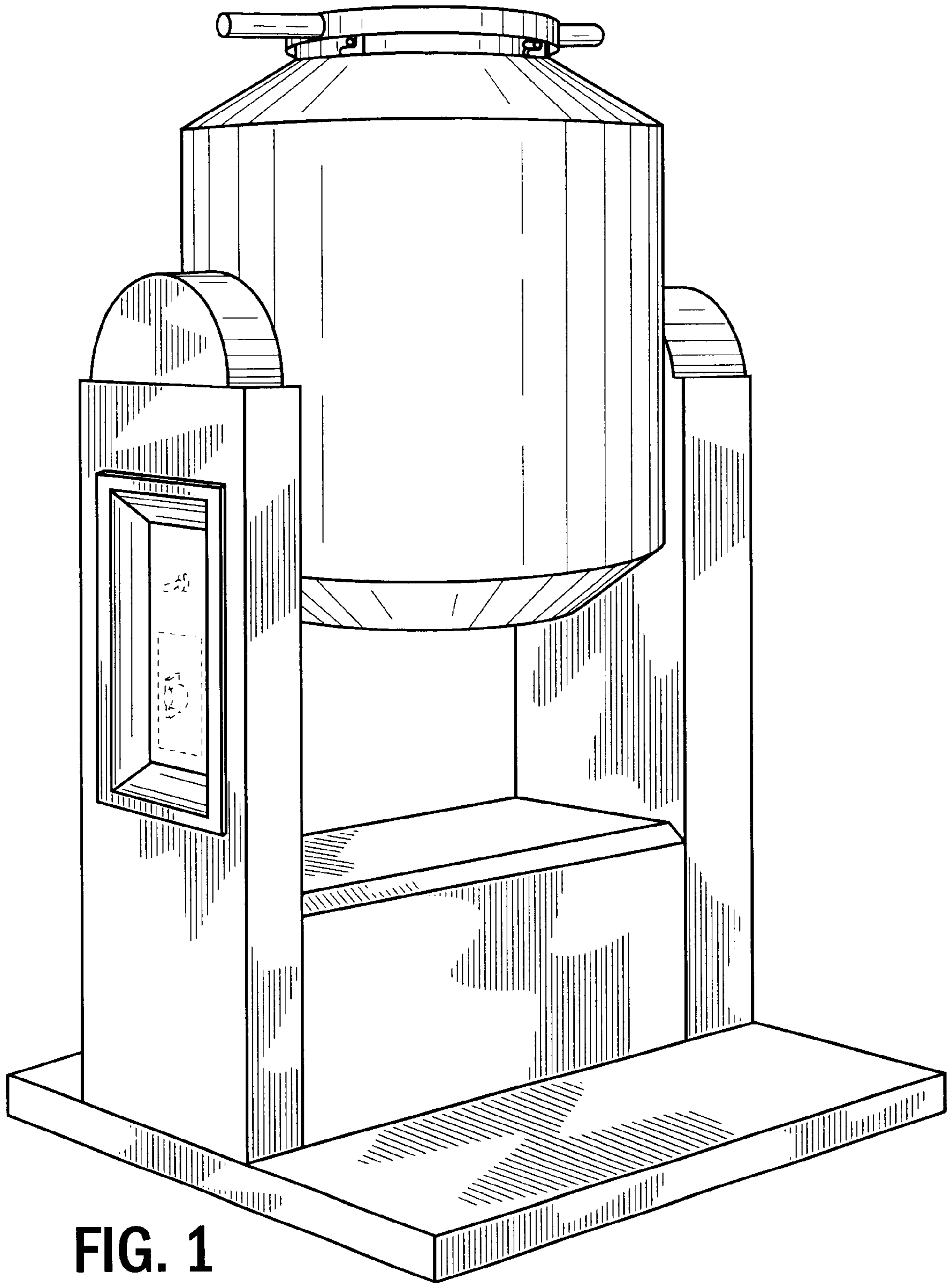

**FIG. 1**

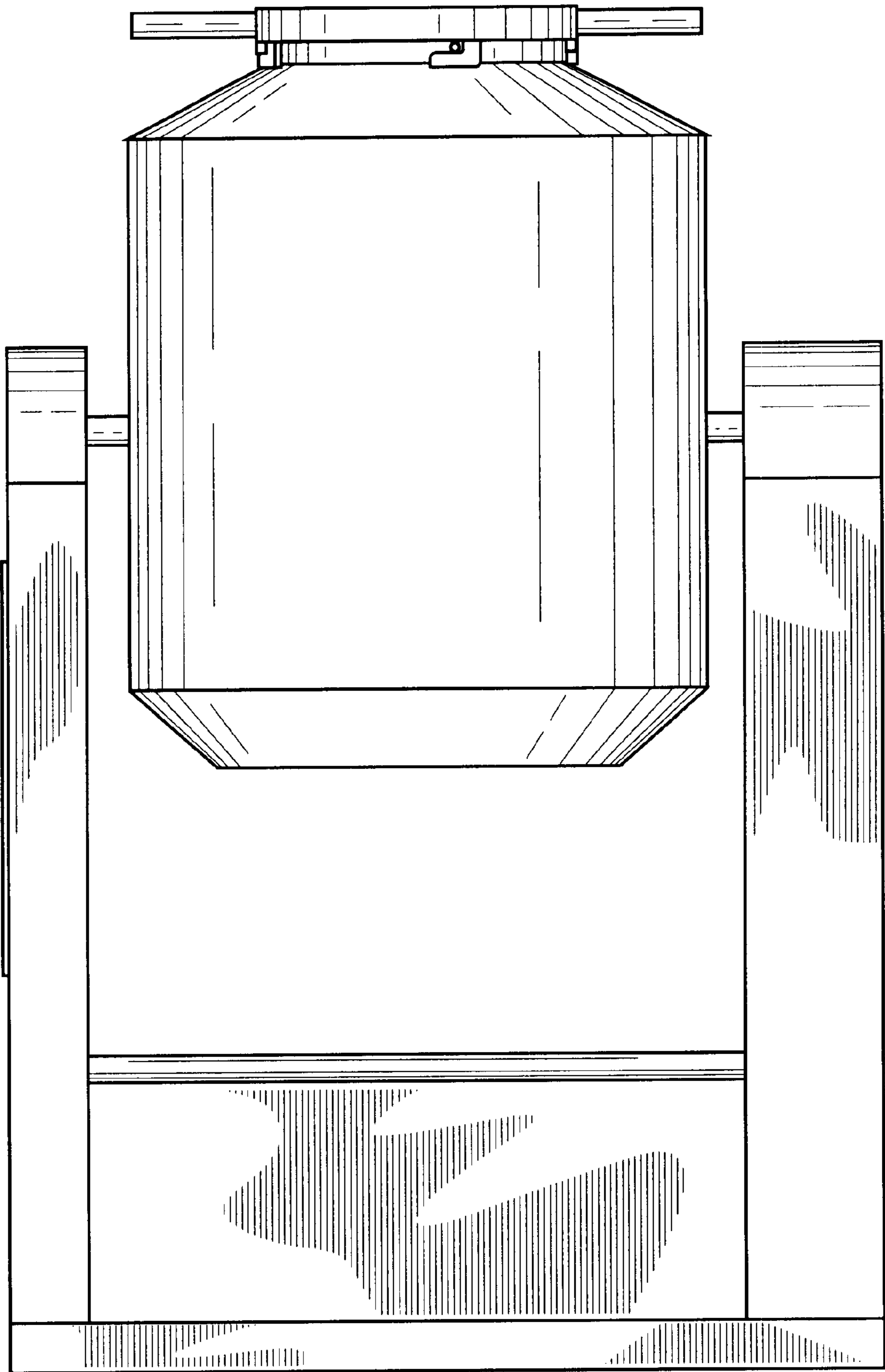

**FIG. 2**

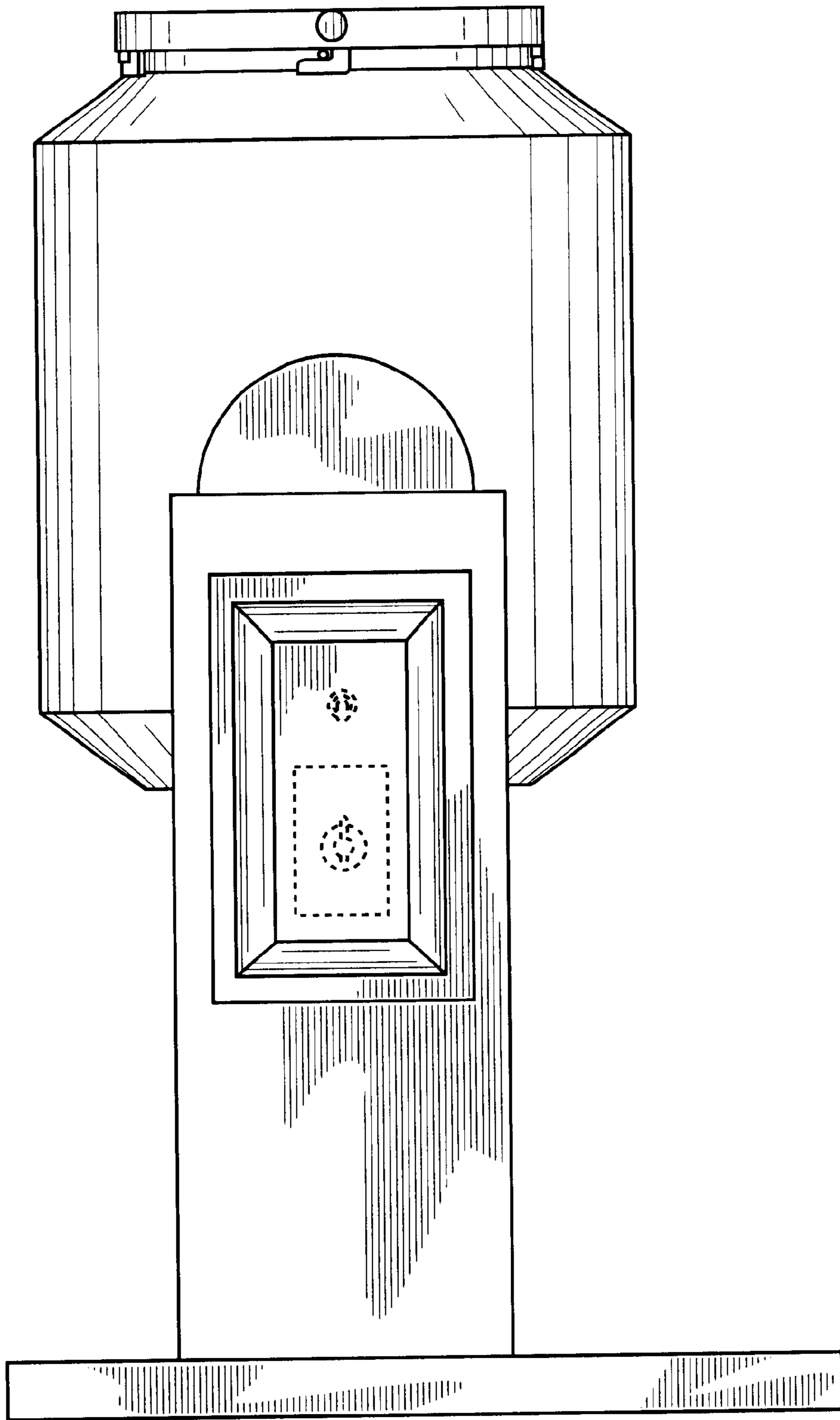
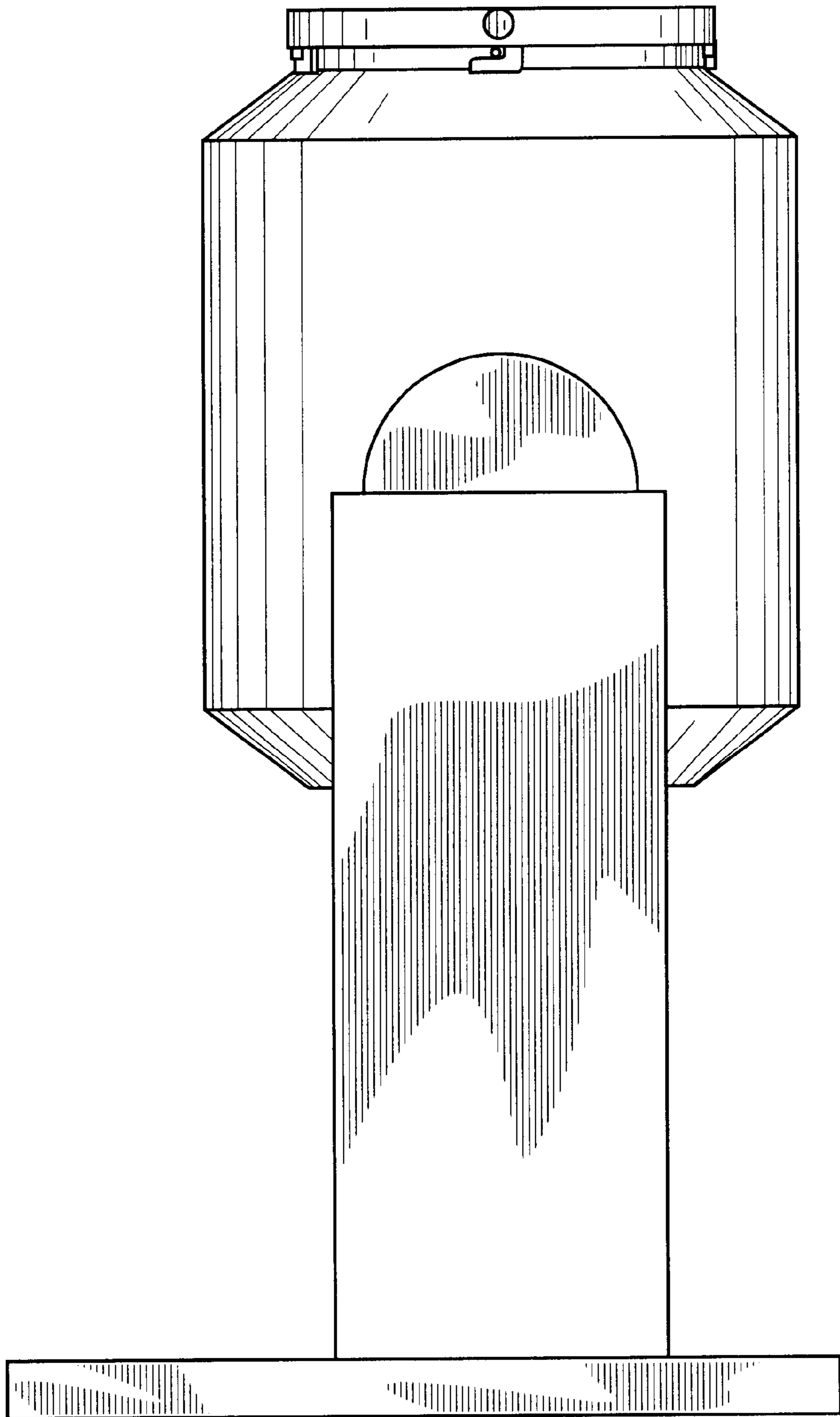

FIG. 3



**FIG. 4**

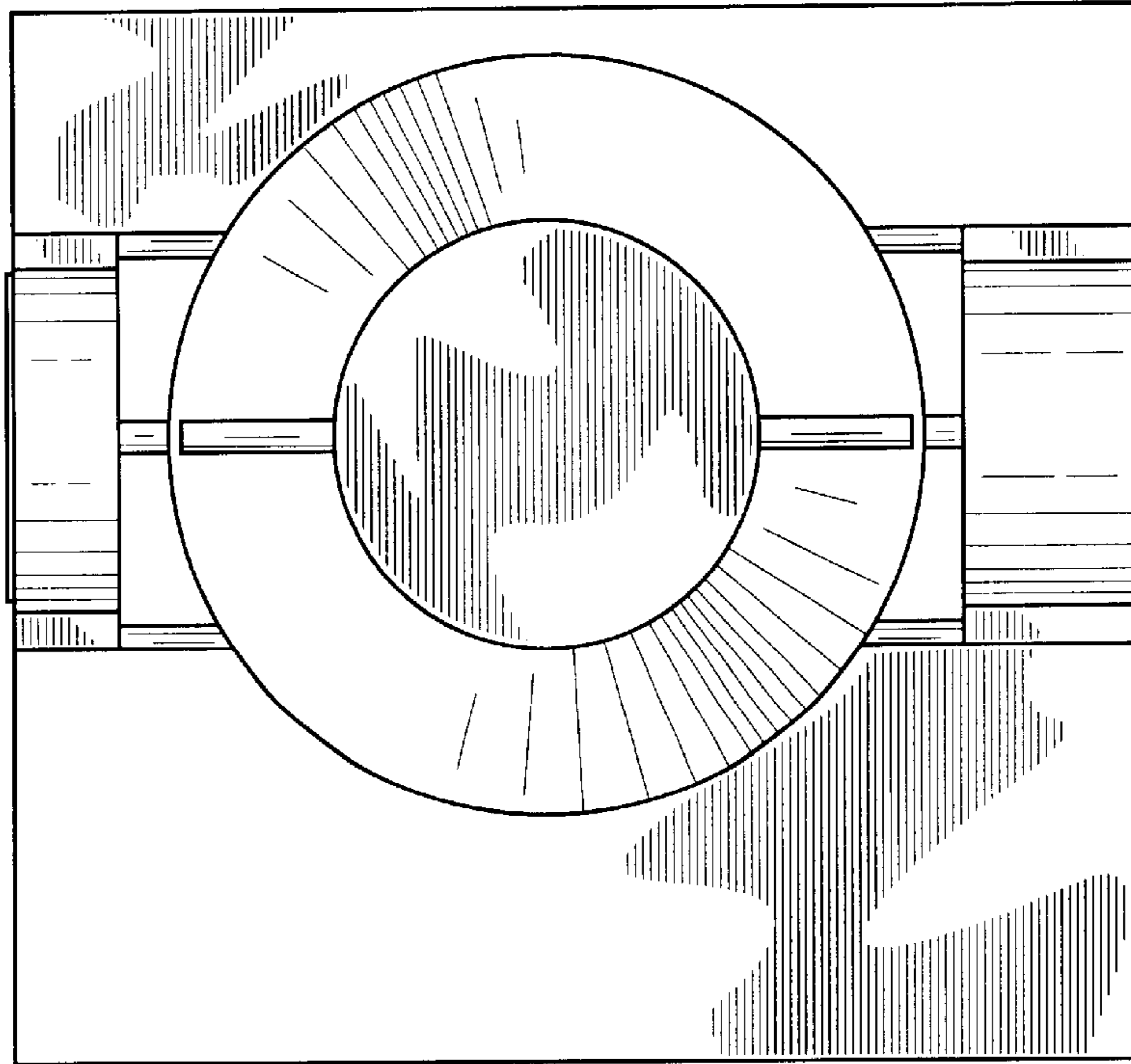

FIG. 5

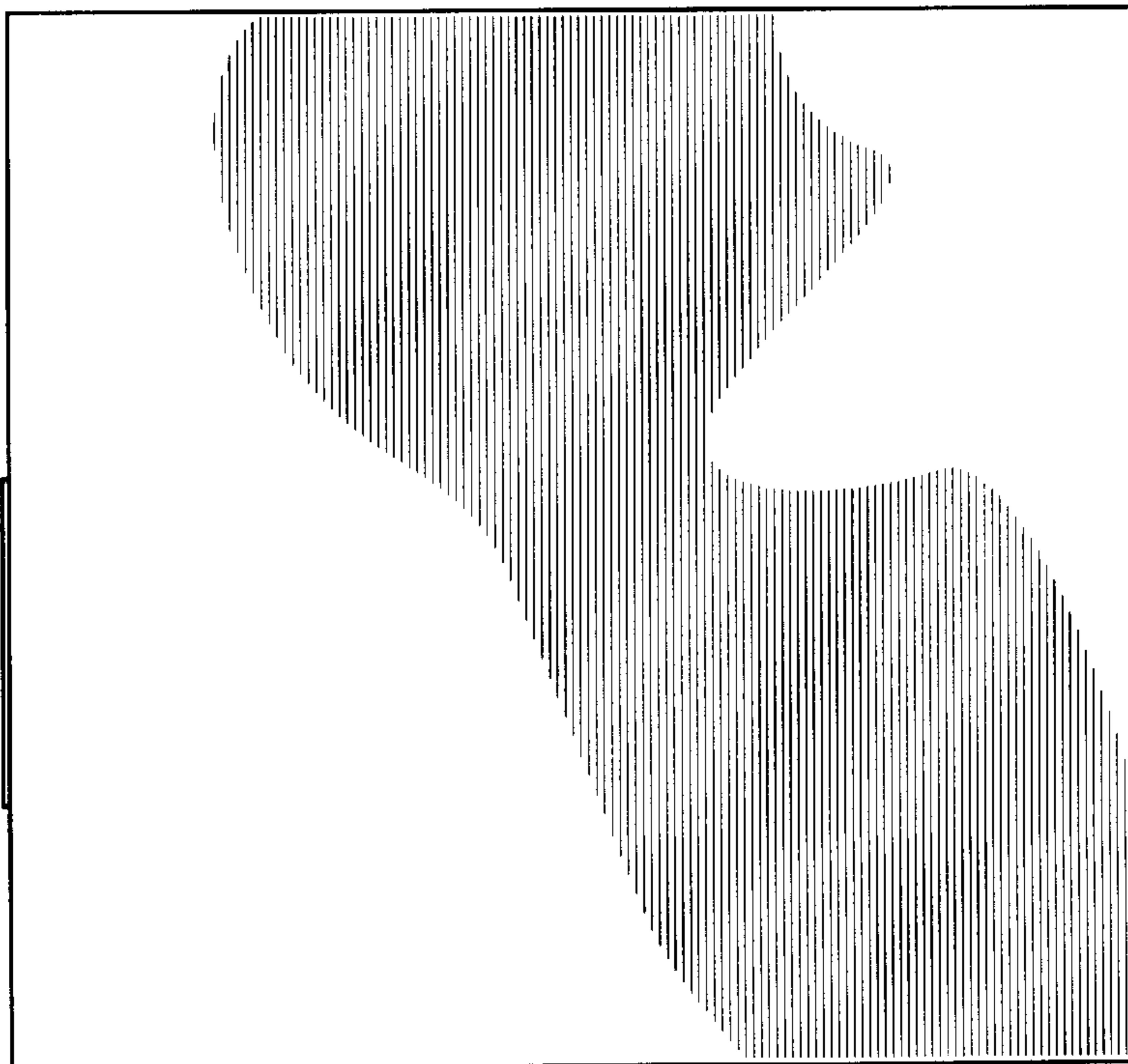

FIG. 6