



US00D473419S

(12) **United States Design Patent**
Garman

(10) **Patent No.:** **US D473,419 S**

(45) **Date of Patent:** **** Apr. 22, 2003**

(54) **HOUSEHOLD ELECTRIC GRILL**

(75) Inventor: **Michael S. Garman**, Stafford, VA (US)

(73) Assignee: **Hamilton Beach/Proctor-Silex, Inc.**,
Glen Allen, VA (US)

(**) Term: **14 Years**

(21) Appl. No.: **29/130,853**

(22) Filed: **Oct. 10, 2000**

(51) **LOC (7) Cl.** **07-02**

(52) **U.S. Cl.** **D7/363**

(58) **Field of Search** D7/323, 352, 362-367,
D7/332, 337-338, 402, 409-410, 328-330;
99/372, 374-376, 379-380, 389, 425, 386,
443 C, 329 RT, 450; 219/450.1, 512

(56) **References Cited**

U.S. PATENT DOCUMENTS

D340,163 S 10/1993 Howard et al.
D351,083 S 10/1994 O'Brien et al.

(List continued on next page.)

Primary Examiner—Ruth McInroy

(74) *Attorney, Agent, or Firm*—Roger S. Dybvig

(57) **CLAIM**

The ornamental design for a household electric grill, as shown and described.

DESCRIPTION

FIG. 1 is a front and top perspective view of a household electric grill showing my new design;
FIG. 2 is a bottom and rear perspective view thereof;
FIG. 3 is a top plan view thereof;
FIG. 4 is a front elevational view thereof;
FIG. 5 is a rear elevational view thereof;
FIG. 6 is a left side elevational view thereof;
FIG. 7 is a right side elevational view thereof;

FIG. 8 is a bottom plan view thereof;
FIG. 9 is a top and front perspective view of a second embodiment thereof;
FIG. 10 is a bottom and rear perspective view thereof;
FIG. 11 is a top plan view thereof;
FIG. 12 is a front elevational view thereof;
FIG. 13 is a rear elevational view thereof;
FIG. 14 is a right side elevational view thereof;
FIG. 15 is a left side elevational view thereof;
FIG. 16 is a bottom plan view thereof;
FIG. 17 is a top and front perspective view of a third embodiment thereof;
FIG. 18 is a bottom and rear perspective view thereof;
FIG. 19 is a top plan view thereof;
FIG. 20 is a front elevational view thereof;
FIG. 21 is a rear elevational view thereof;
FIG. 22 is a right side elevational view thereof;
FIG. 23 is a left side elevational view thereof;
FIG. 24 is a bottom plan view thereof;
FIG. 25 is a top and front perspective view of a fourth embodiment thereof;
FIG. 26 is a bottom and rear perspective view thereof;
FIG. 27 is a top plan view thereof;
FIG. 28 is a front elevational view thereof;
FIG. 29 is a rear elevational view thereof;
FIG. 30 is a right side elevational view thereof;
FIG. 31 is a left side elevational view thereof;
FIG. 32 is a bottom plan view thereof;
FIG. 33 is a top and front perspective view of a fifth embodiment thereof;
FIG. 34 is a bottom and rear perspective view thereof;
FIG. 35 is a top plan view thereof;
FIG. 36 is a front elevational view thereof;
FIG. 37 is a rear elevational view thereof;
FIG. 38 is a right side elevational view thereof;
FIG. 39 is a left side elevational view thereof; and,
FIG. 40 is a bottom plan view thereof.
The broken lines in FIG. 8 showing support legs and a rib are for illustration only and form no part of the claimed design.

1 Claim, 15 Drawing Sheets

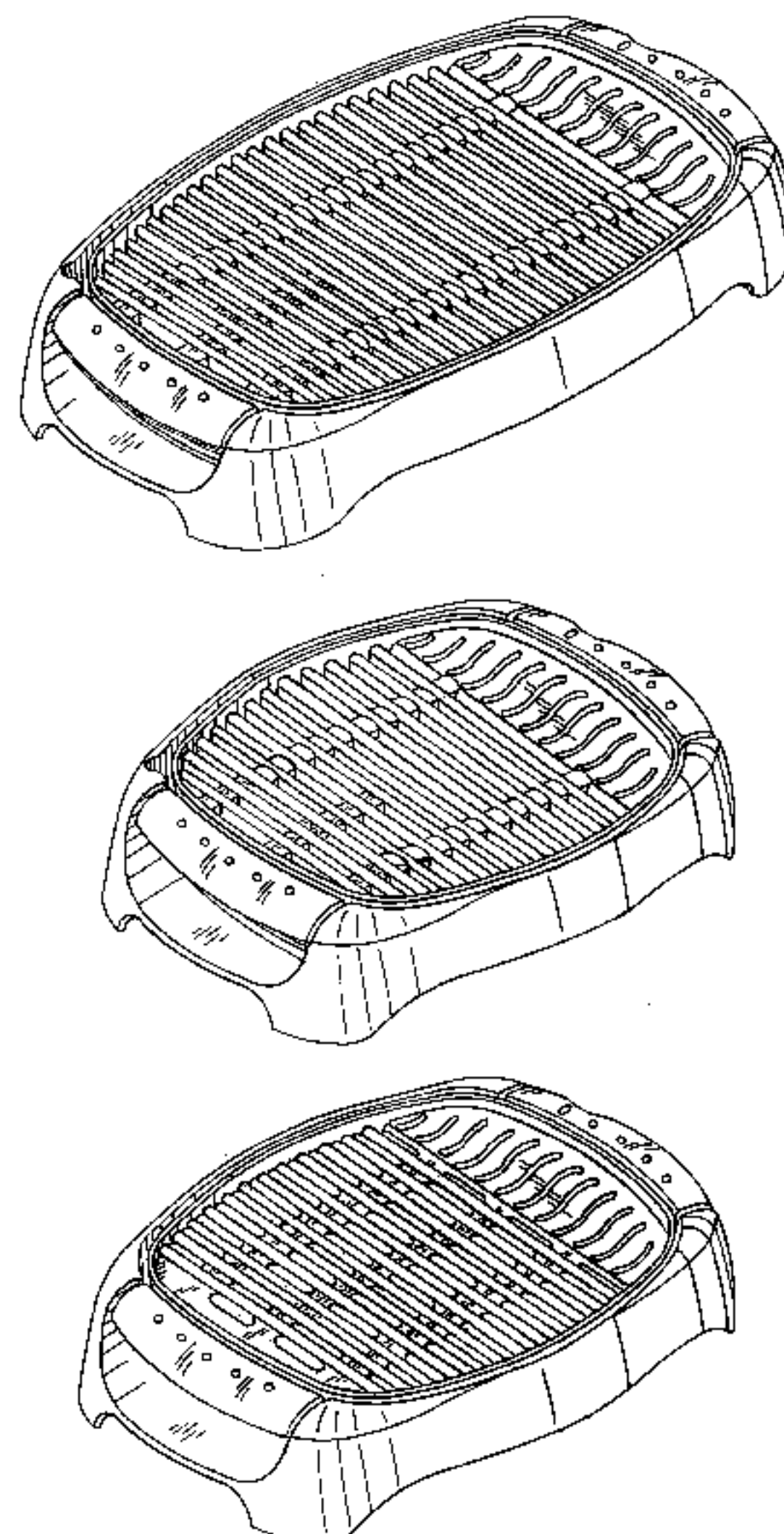

US D473,419 S

Page 2

U.S. PATENT DOCUMENTS

D369,059 S	4/1996	Carnovali	D416,167 S	11/1999	Barker
D377,134 S	* 1/1997	Touche D7/362	6,024,014 A	* 2/2000	Kasai 99/425
D377,579 S	1/1997	O'Brien et al.	D424,367 S	5/2000	Choi
D380,342 S	7/1997	Edmonds	6,064,042 A	* 5/2000	Glucksman et al. ... 219/452.13
D394,584 S	5/1998	Weber	D431,152 S	* 9/2000	Lee D7/362
D406,723 S	3/1999	Lee	D432,852 S	* 10/2000	Mosher, II et al. D7/337
D415,927 S	11/1999	Weber	6,262,399 B1	* 7/2001	Lau et al. 219/450.1

* cited by examiner

FIG-1

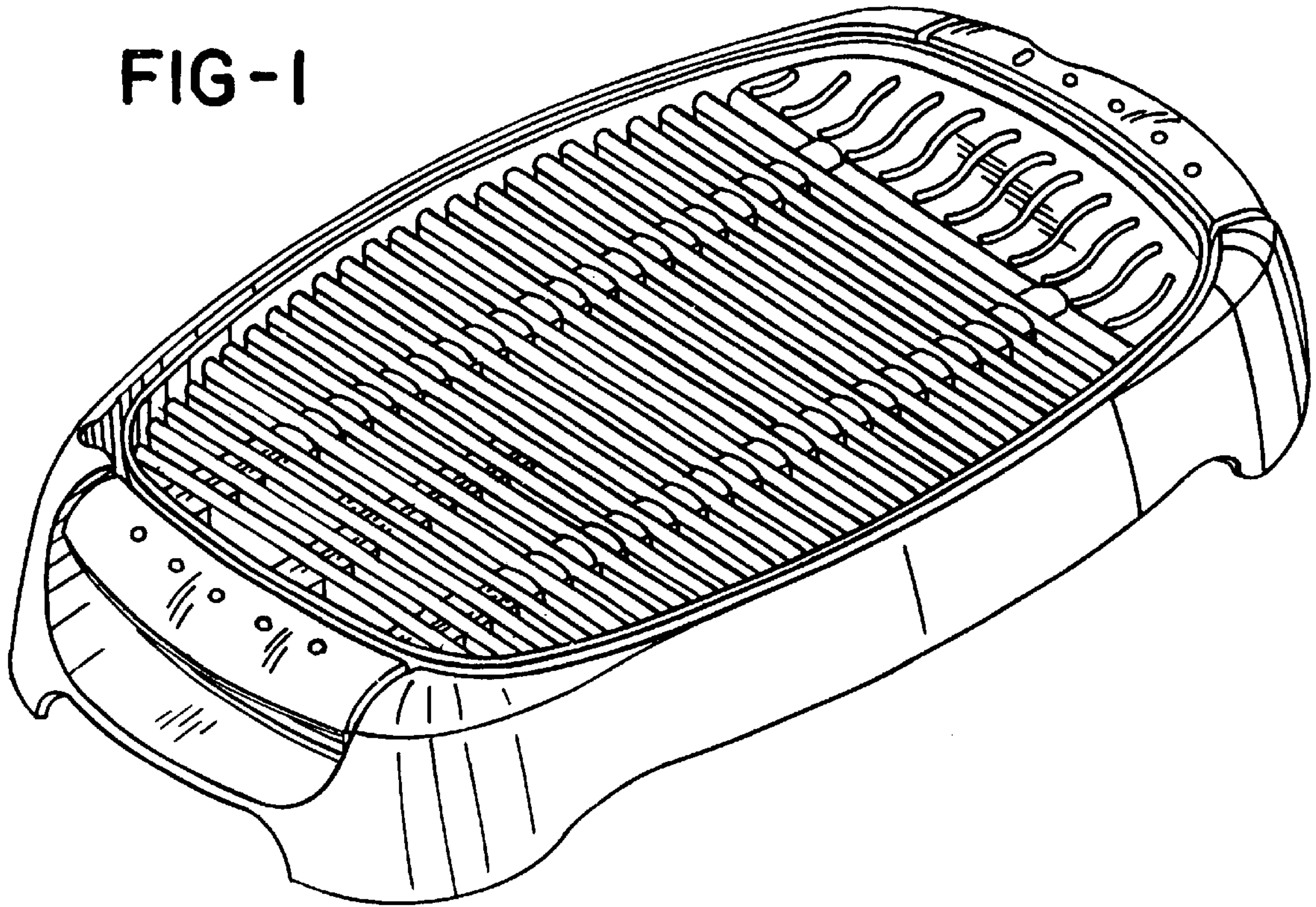

FIG-2

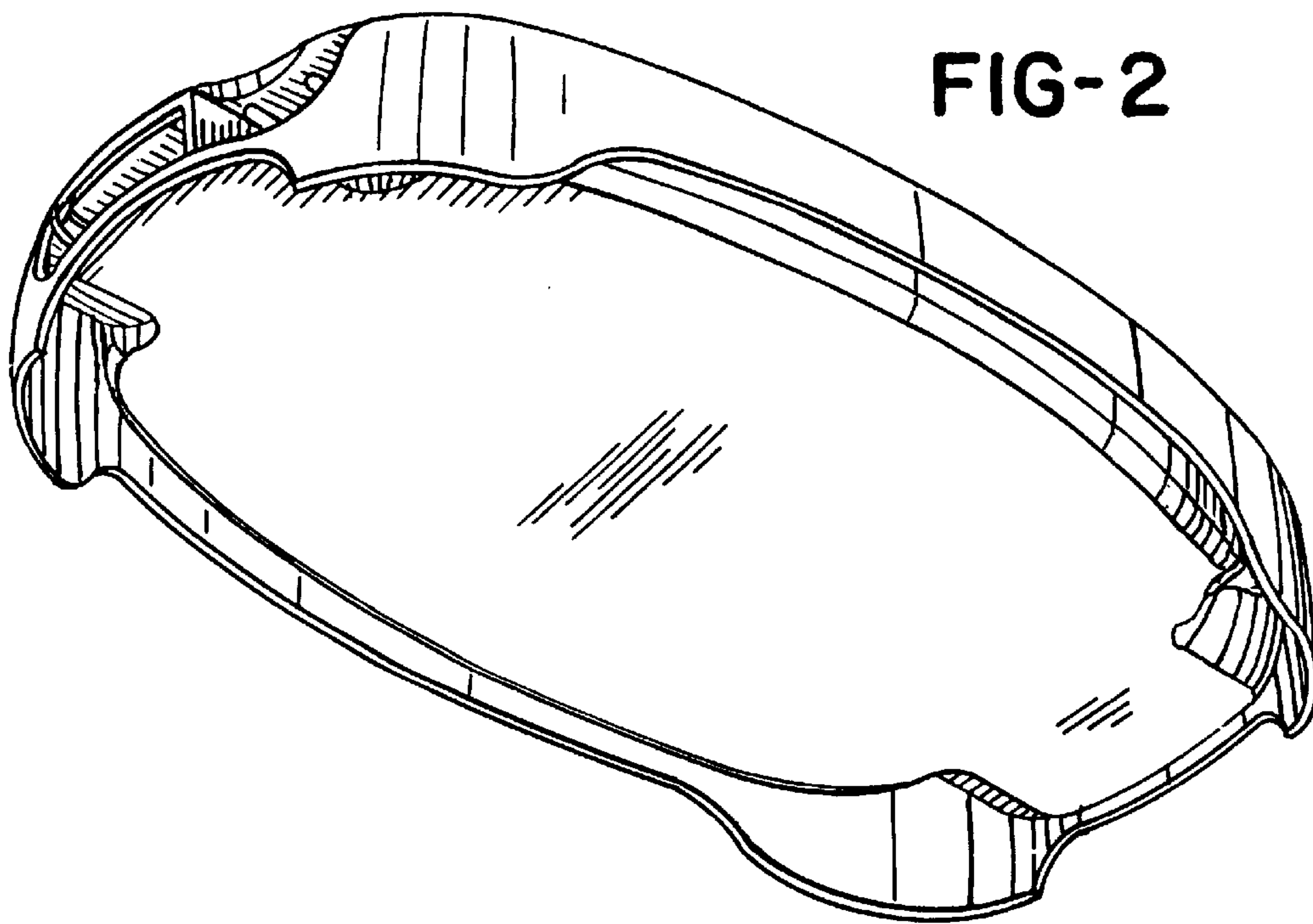

FIG-3

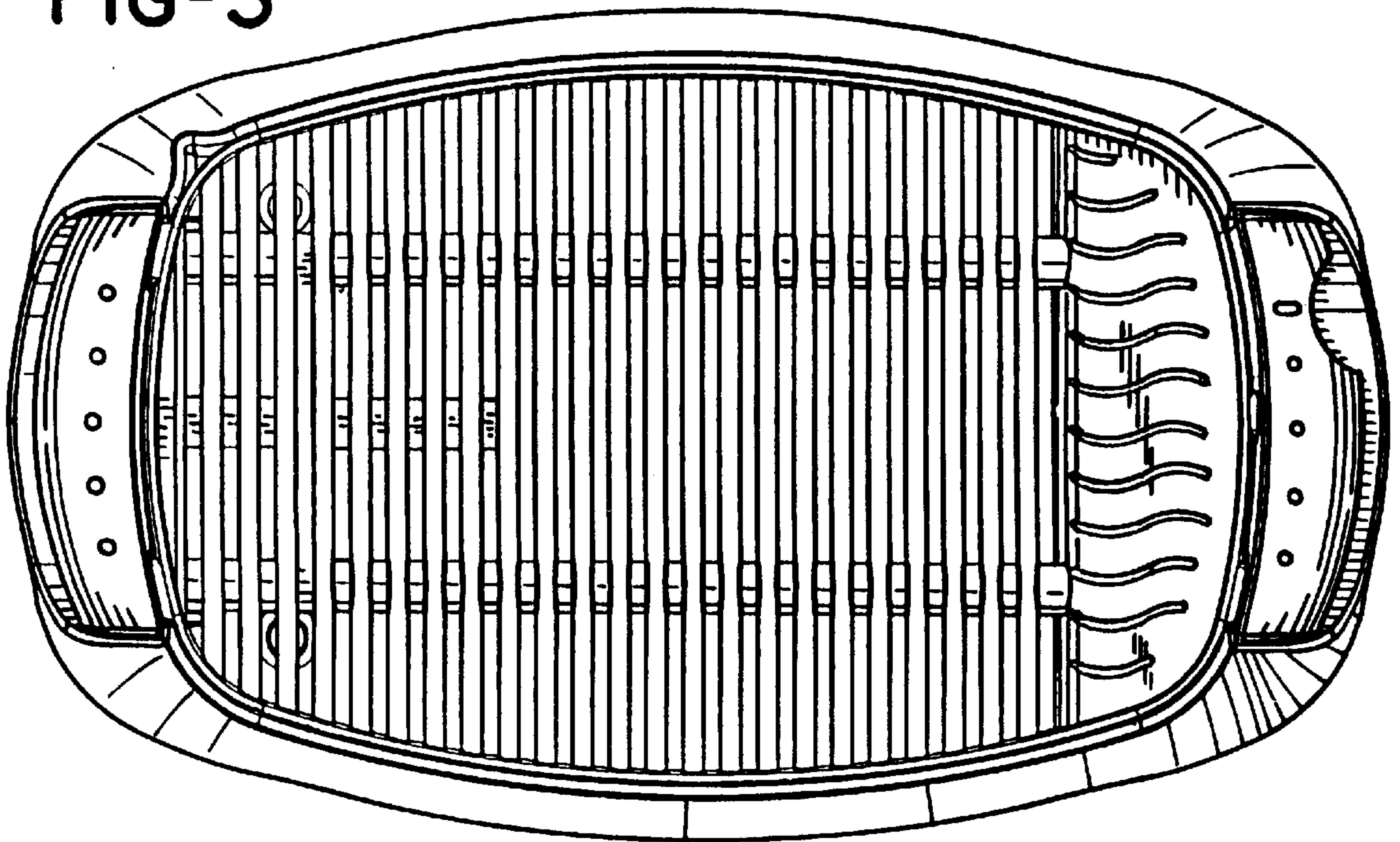

FIG-4

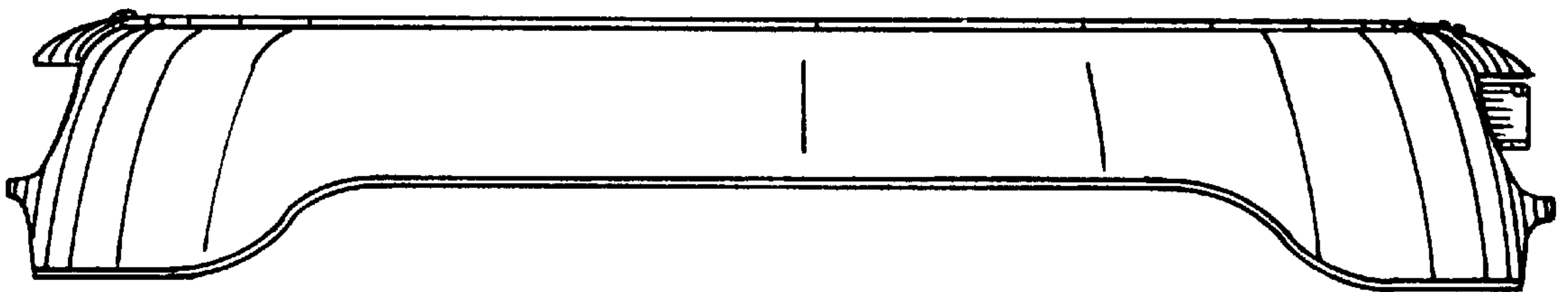

FIG-5

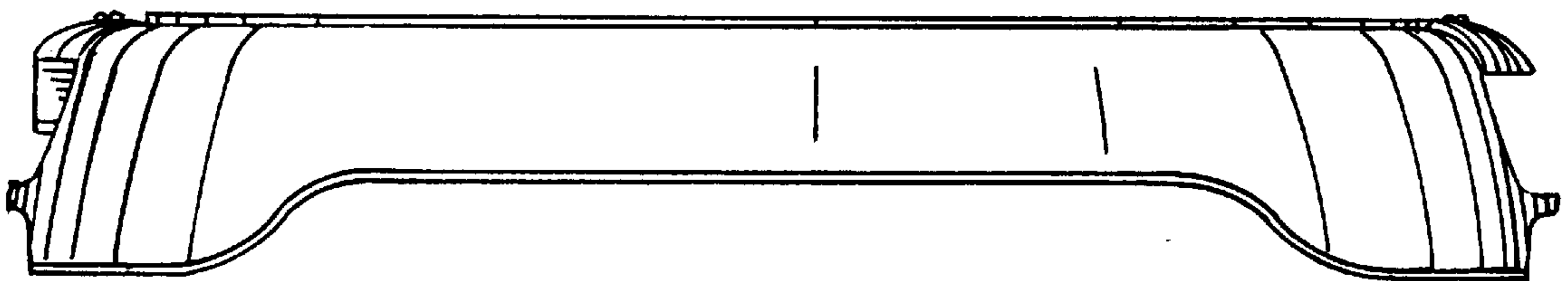

FIG-6

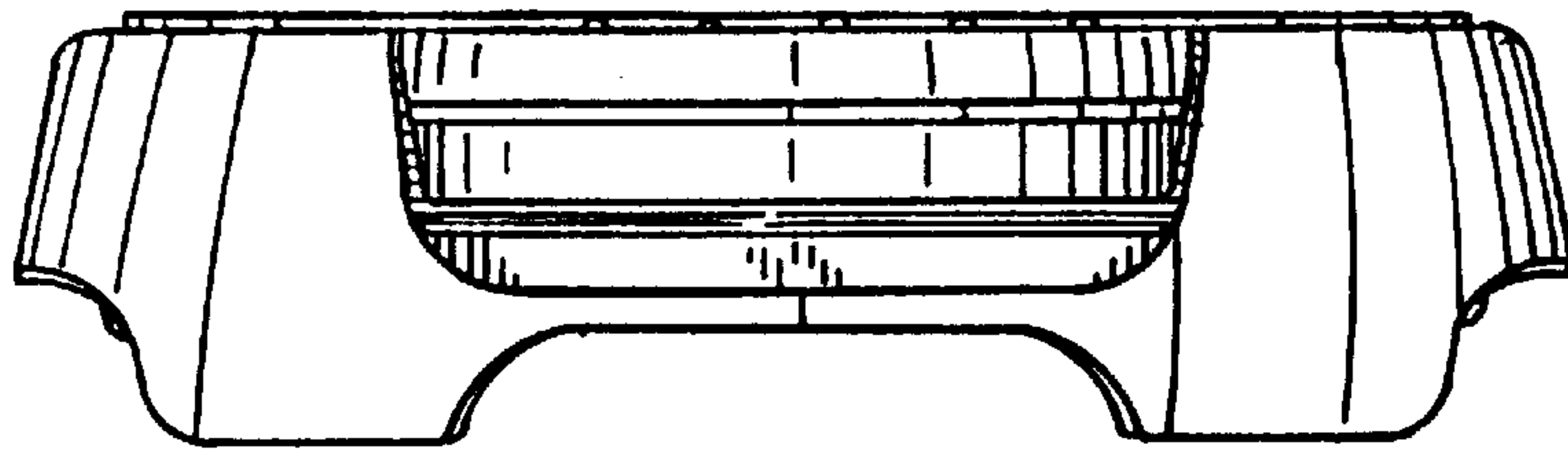

FIG-7

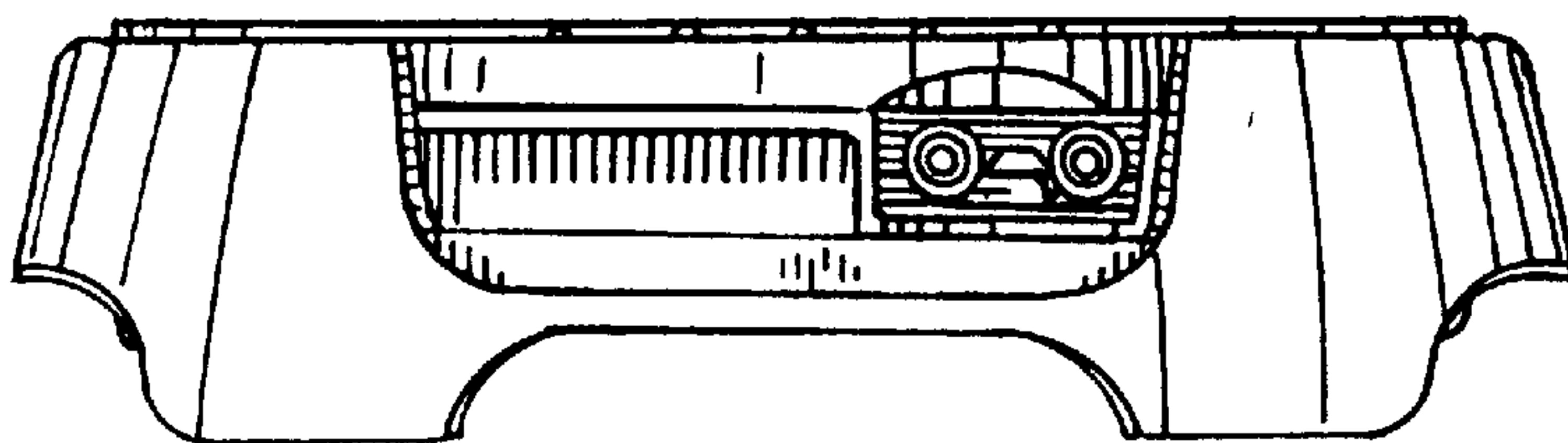

FIG-8

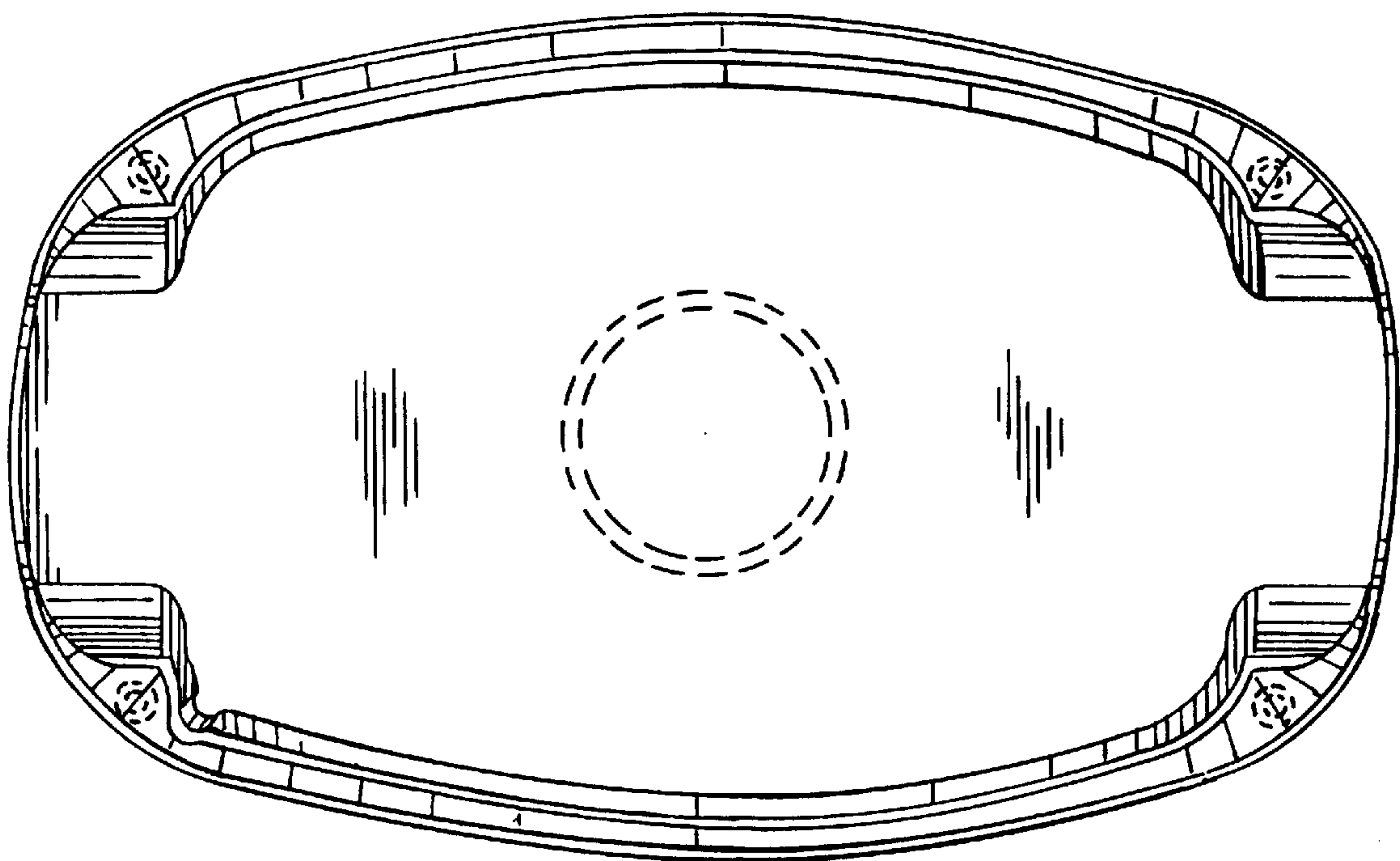

FIG-9

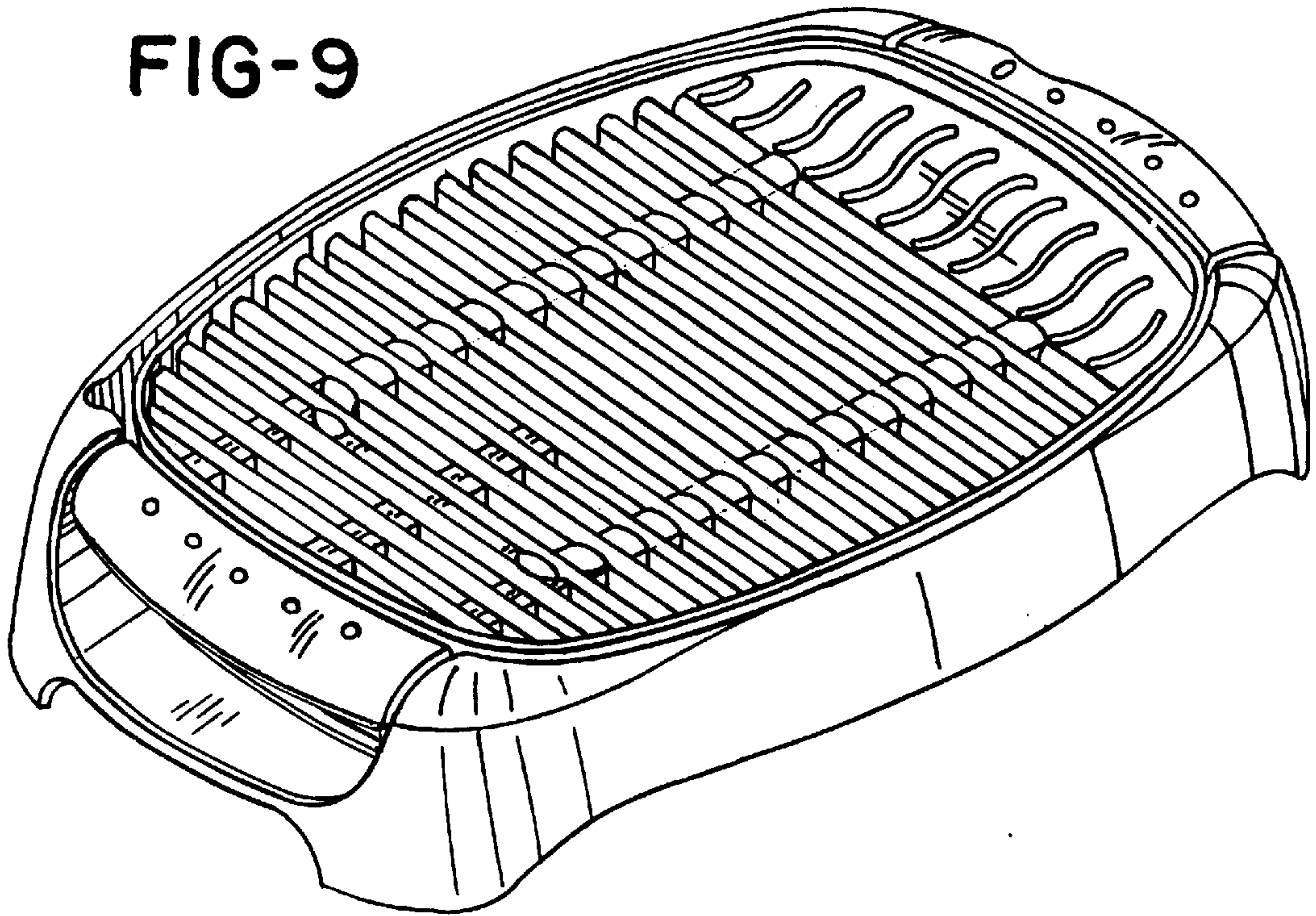

FIG-10

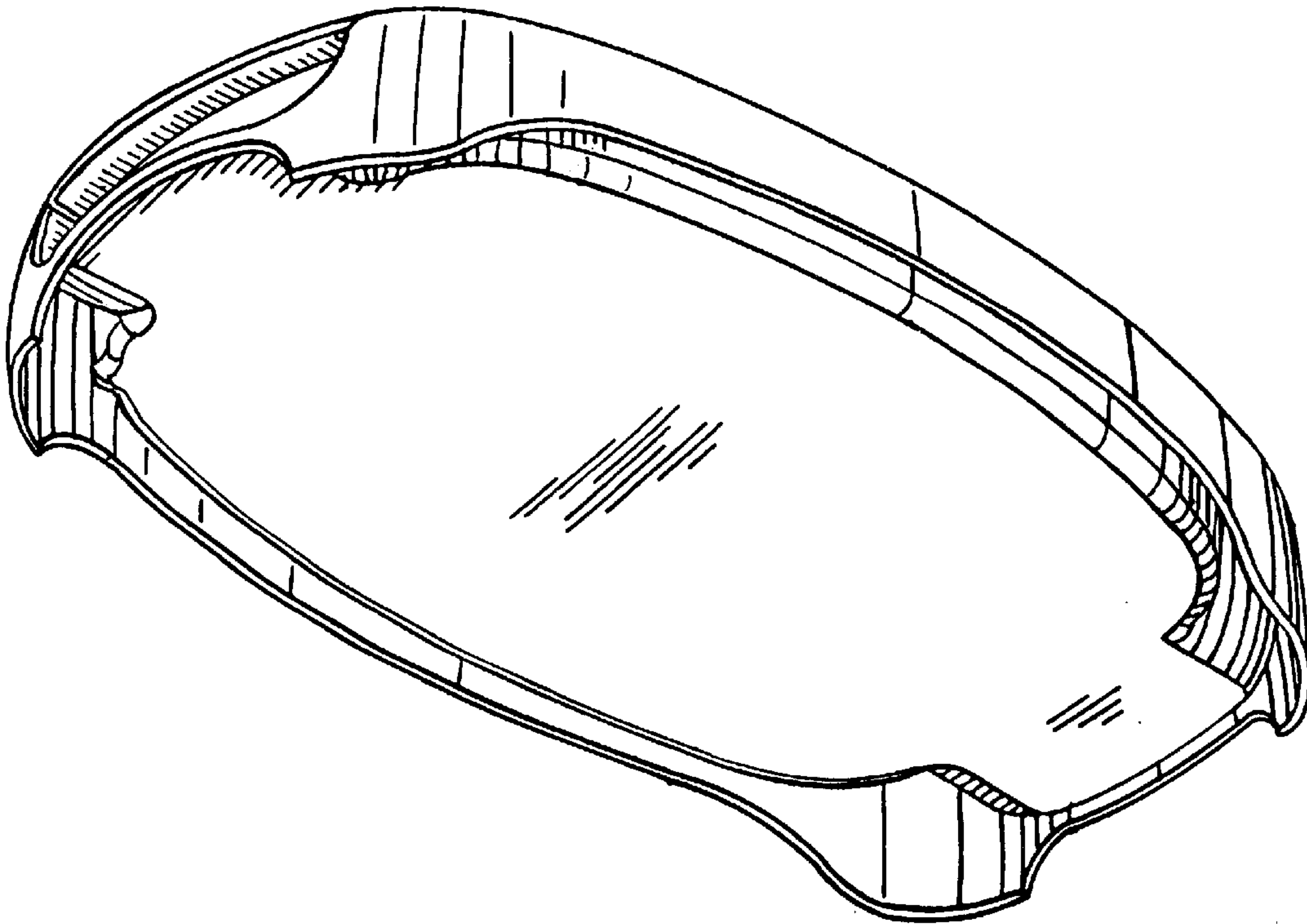

FIG-11

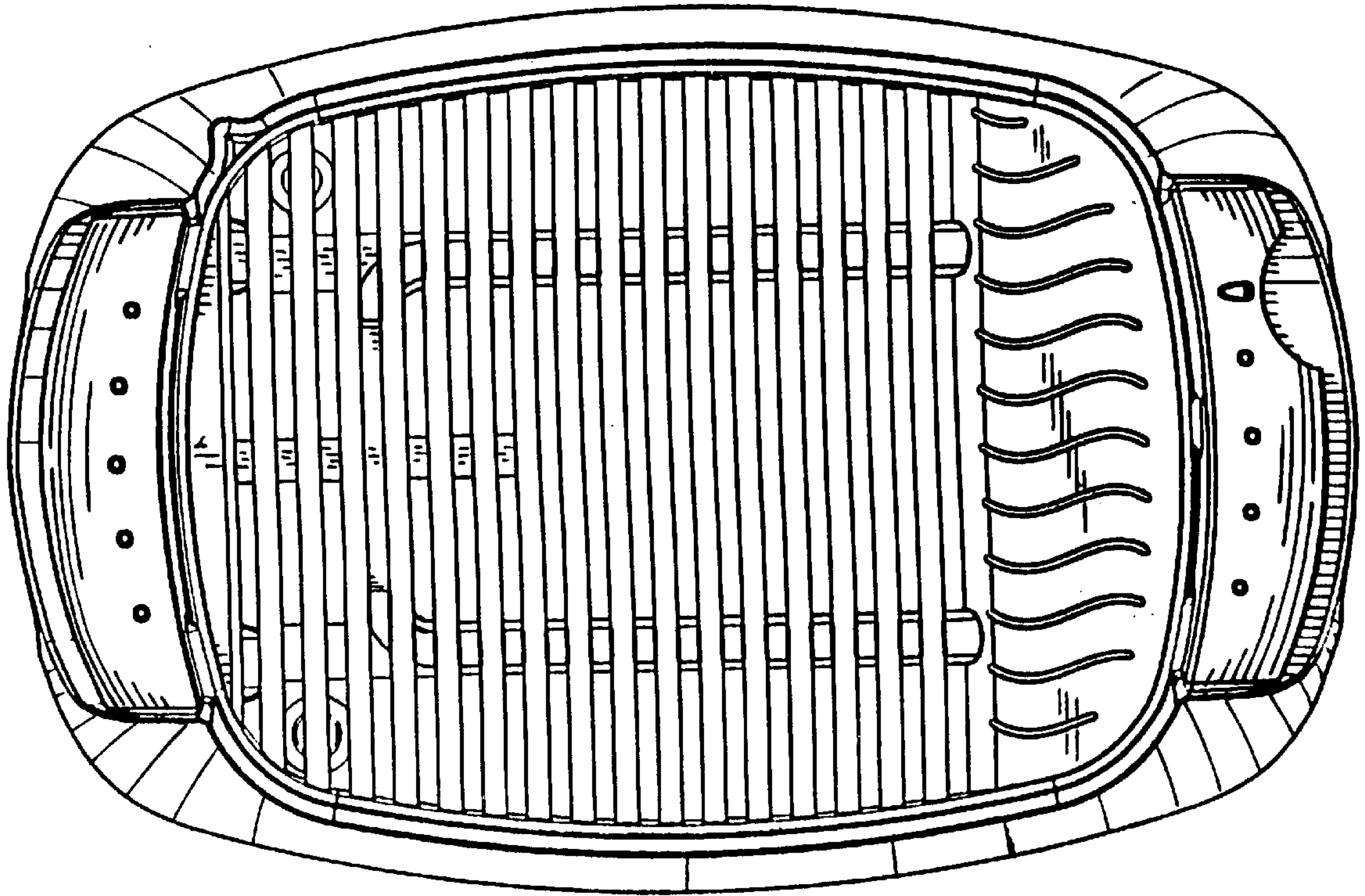

FIG-12

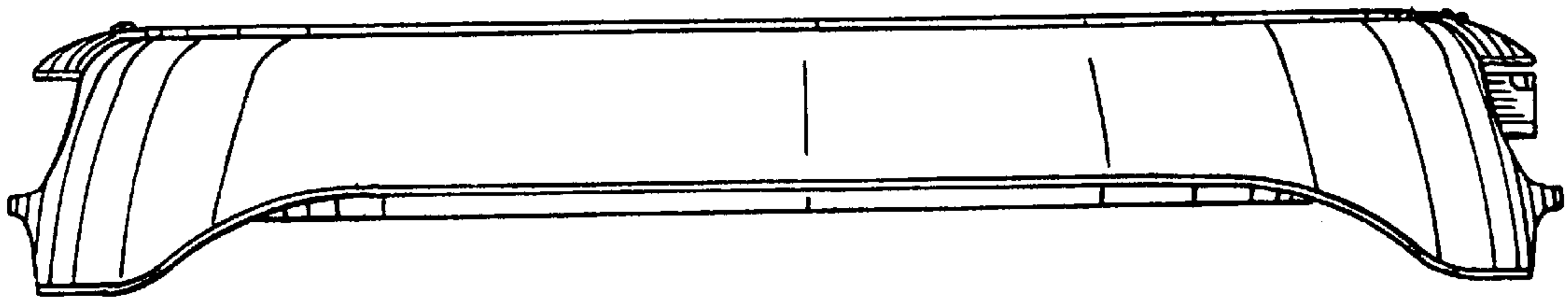

FIG-13

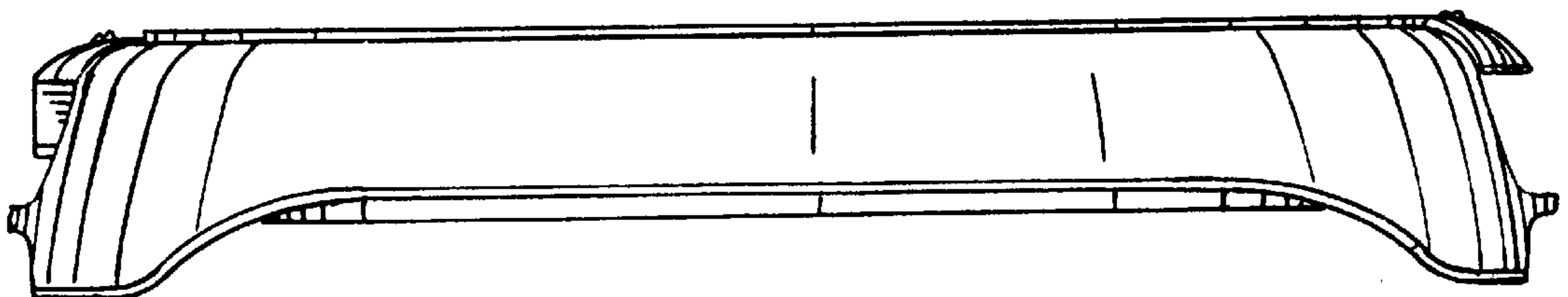

FIG-14

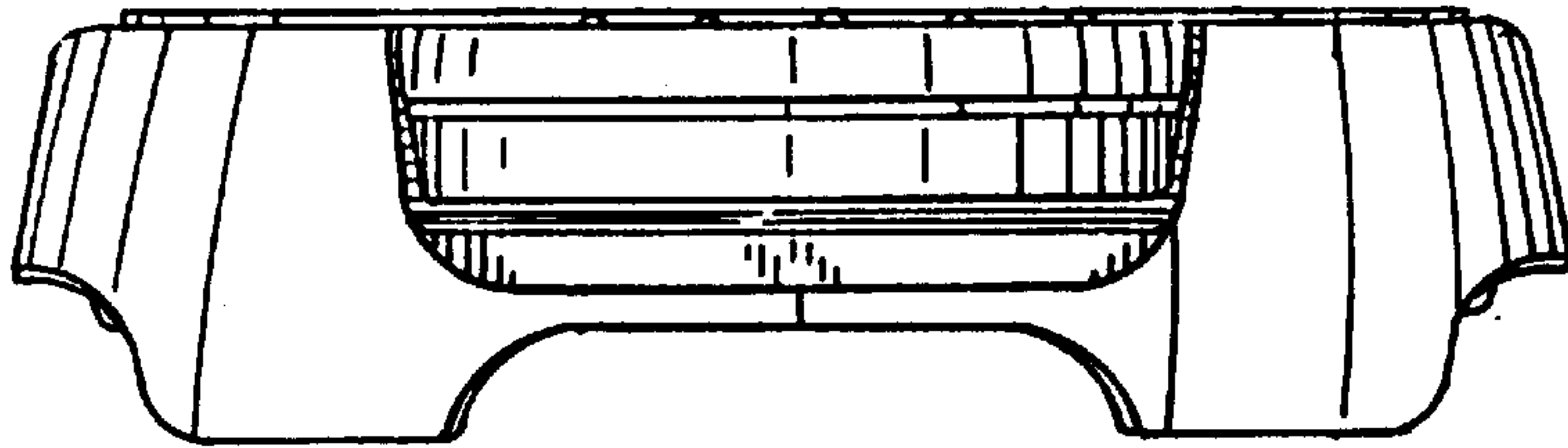

FIG-15

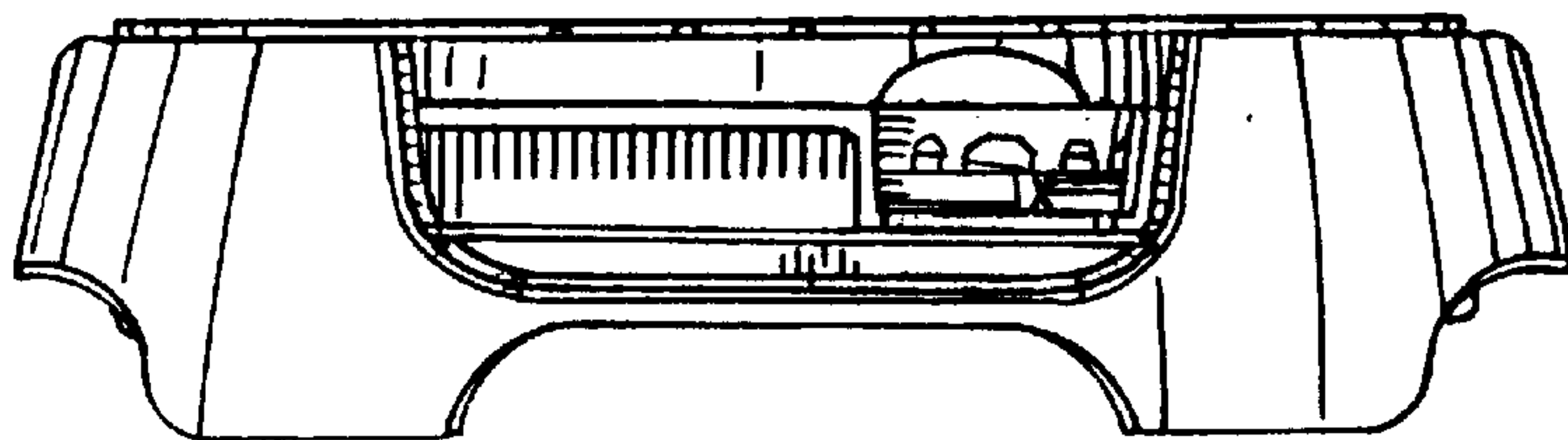

FIG-16

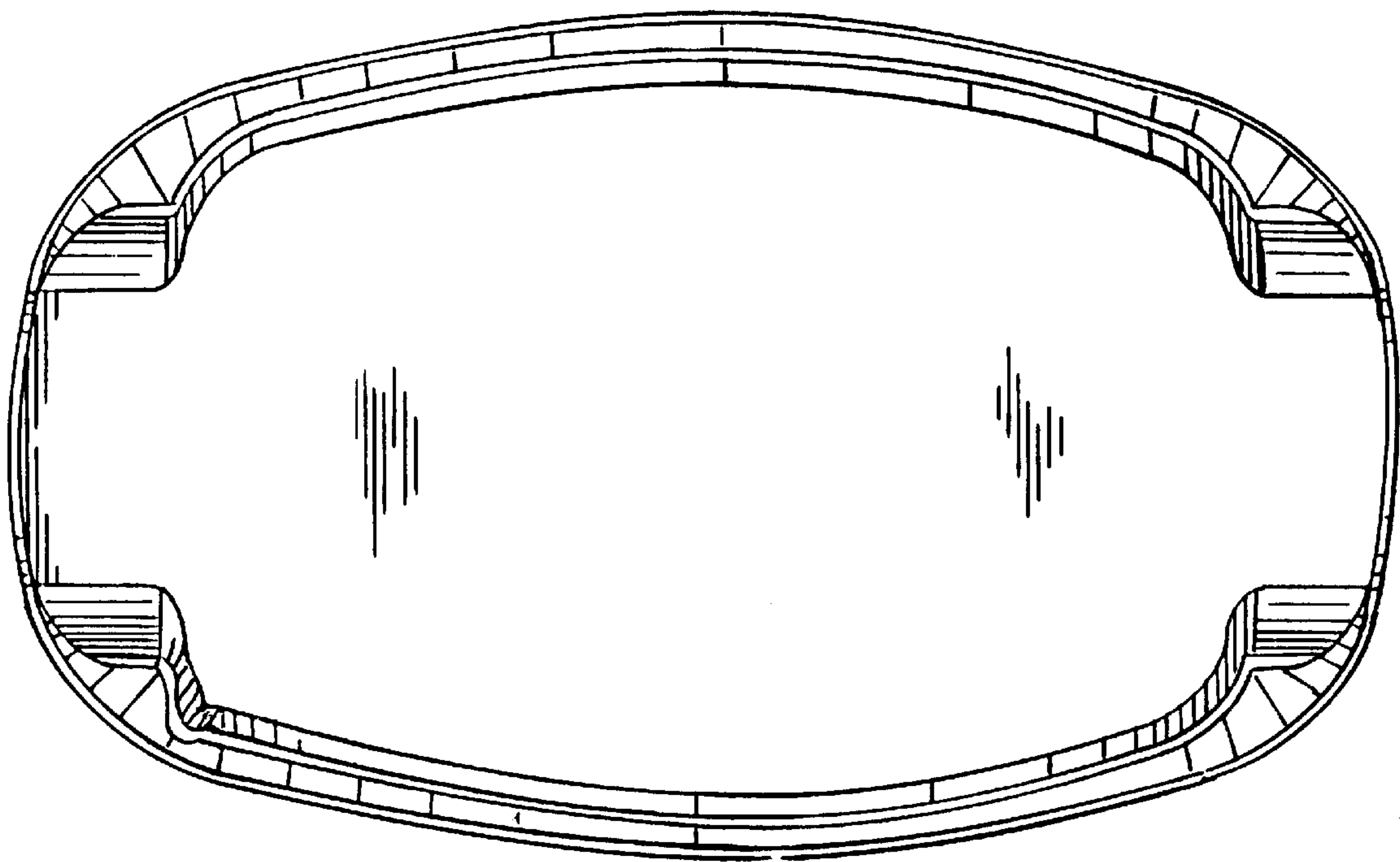

FIG-17

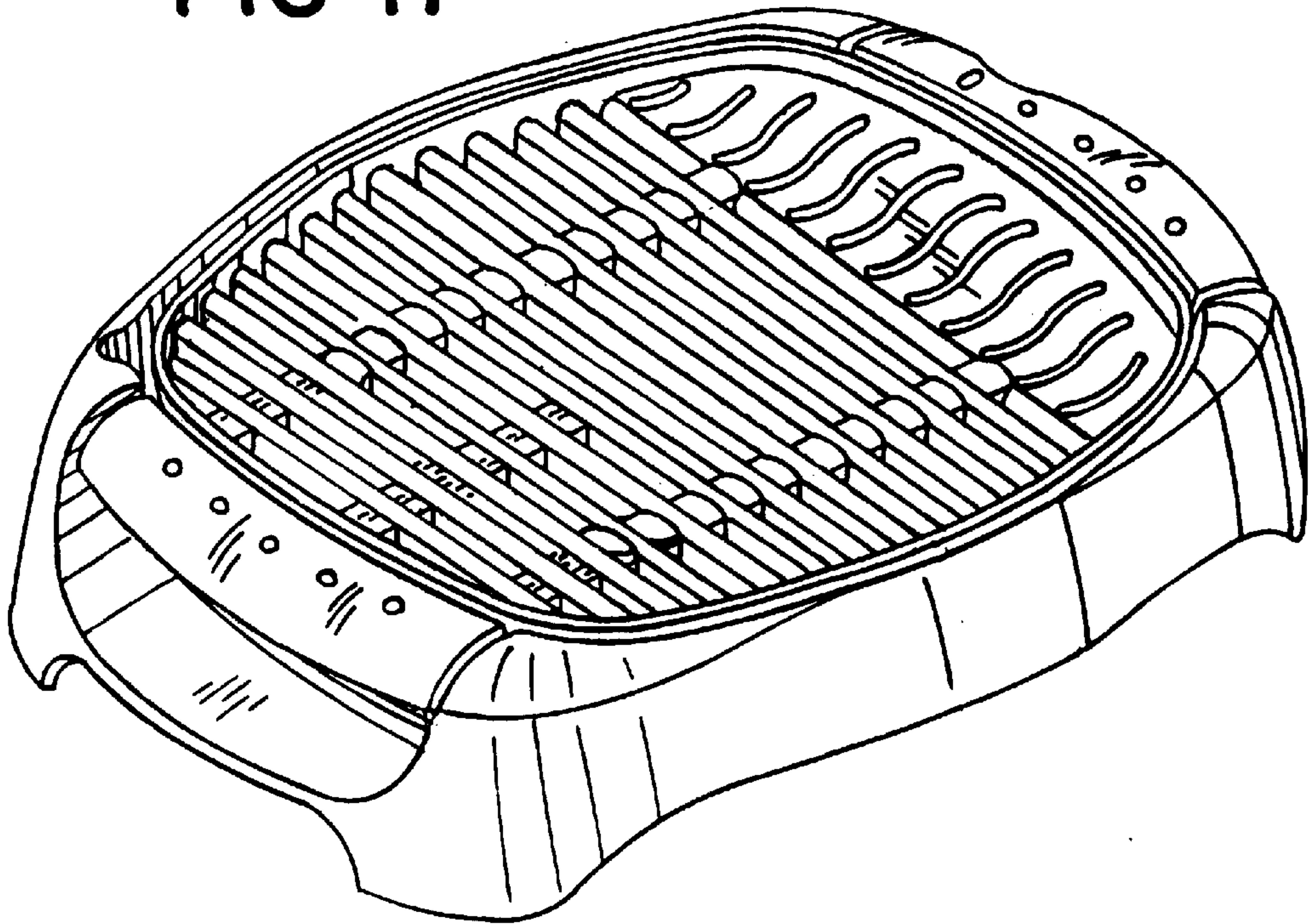

FIG-18

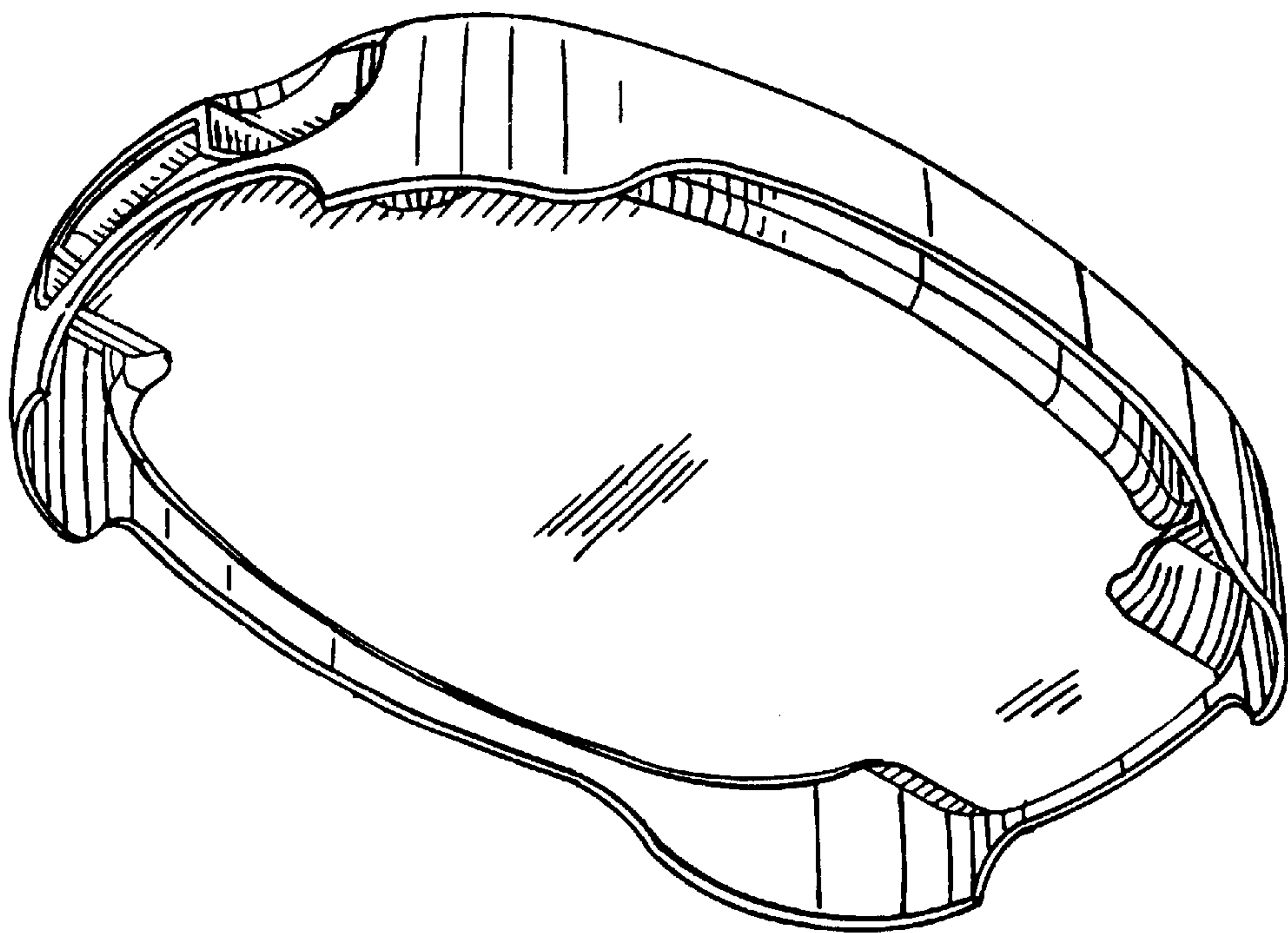

FIG-19

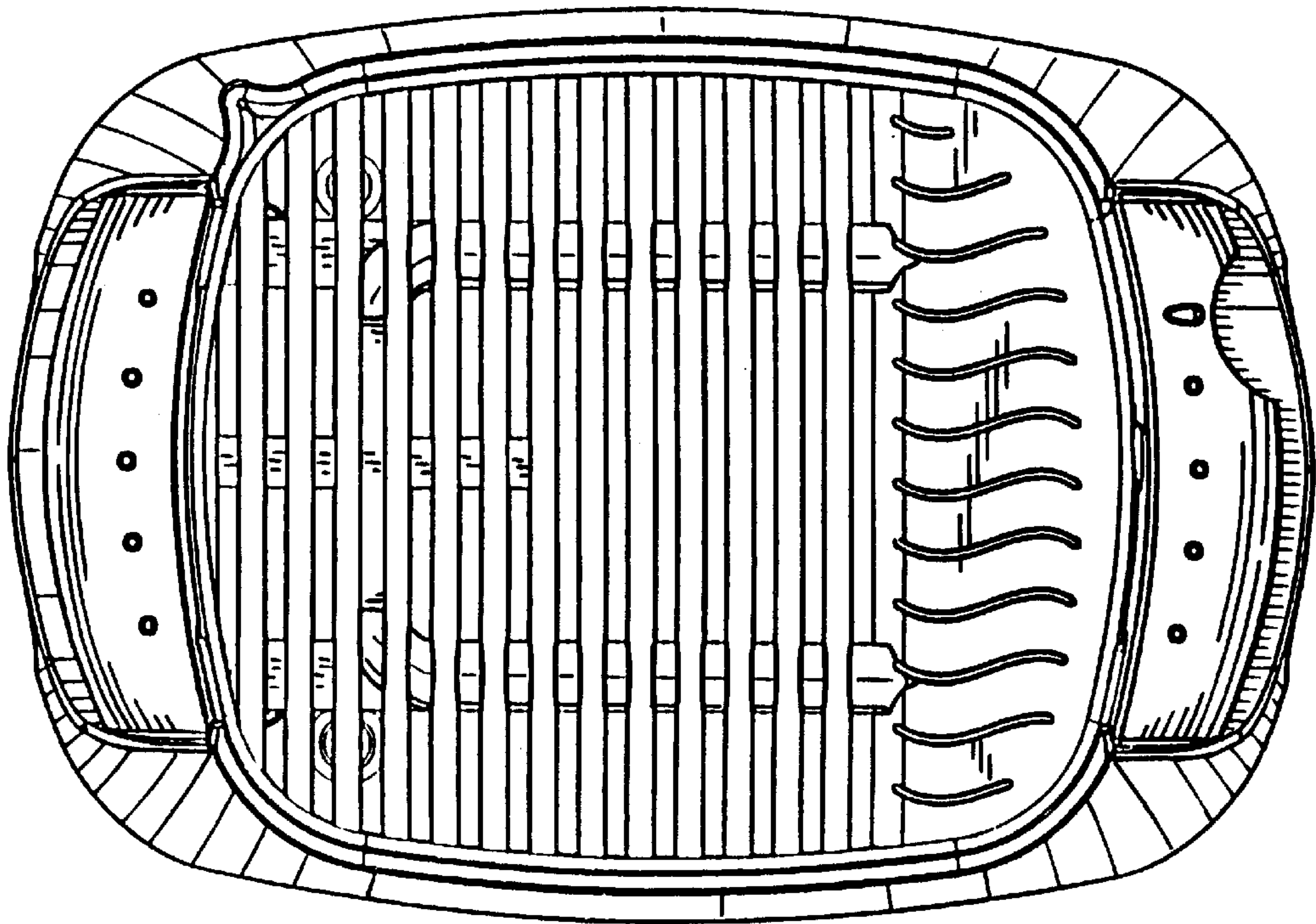

FIG-20

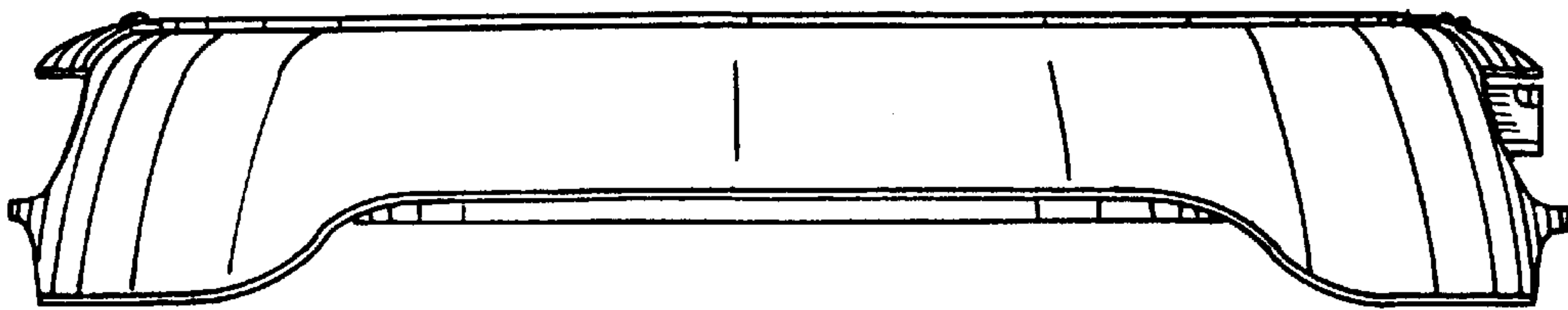

FIG-21

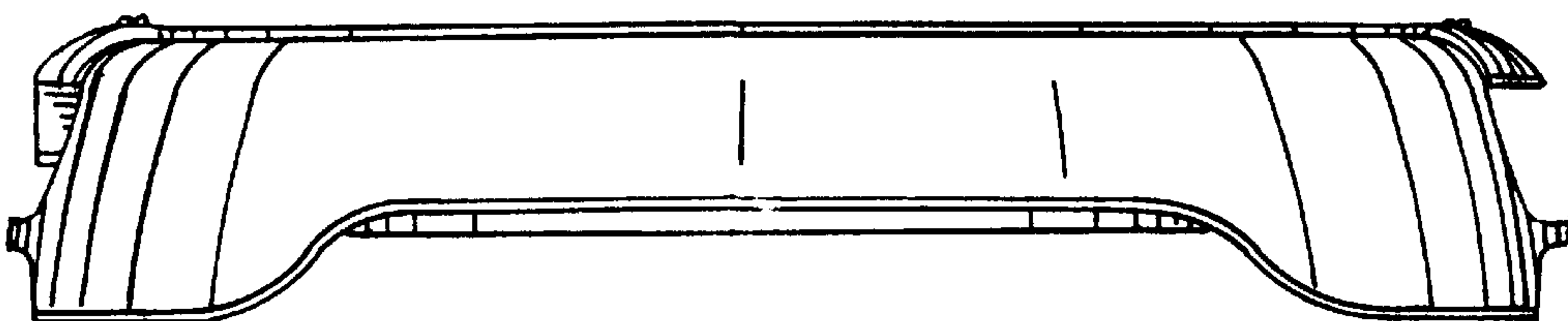

FIG-22

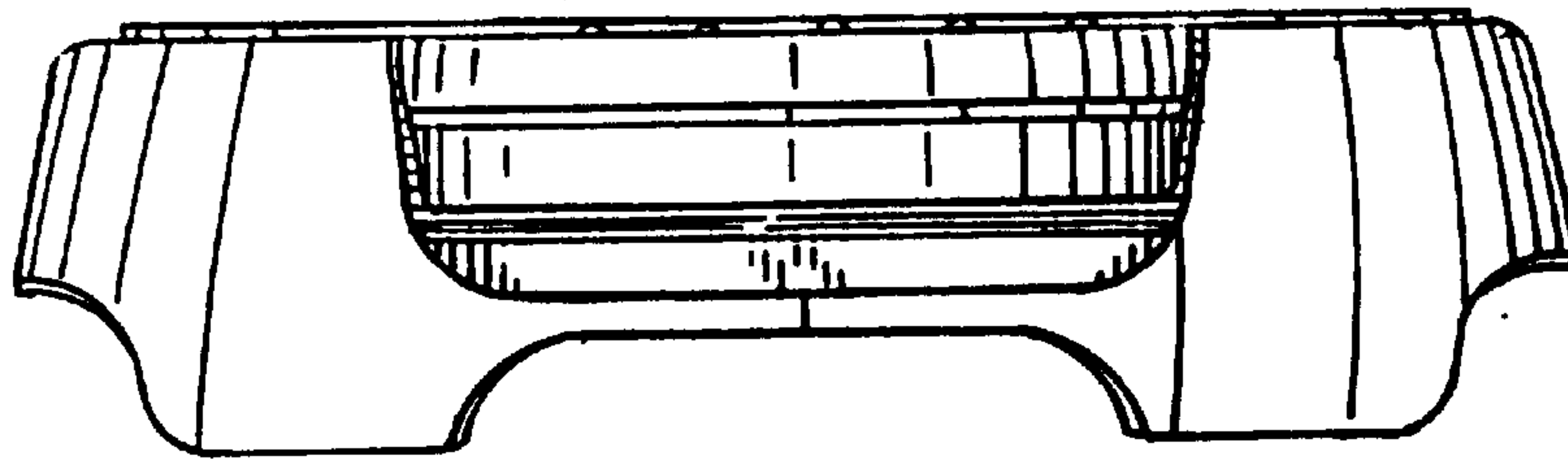

FIG-23

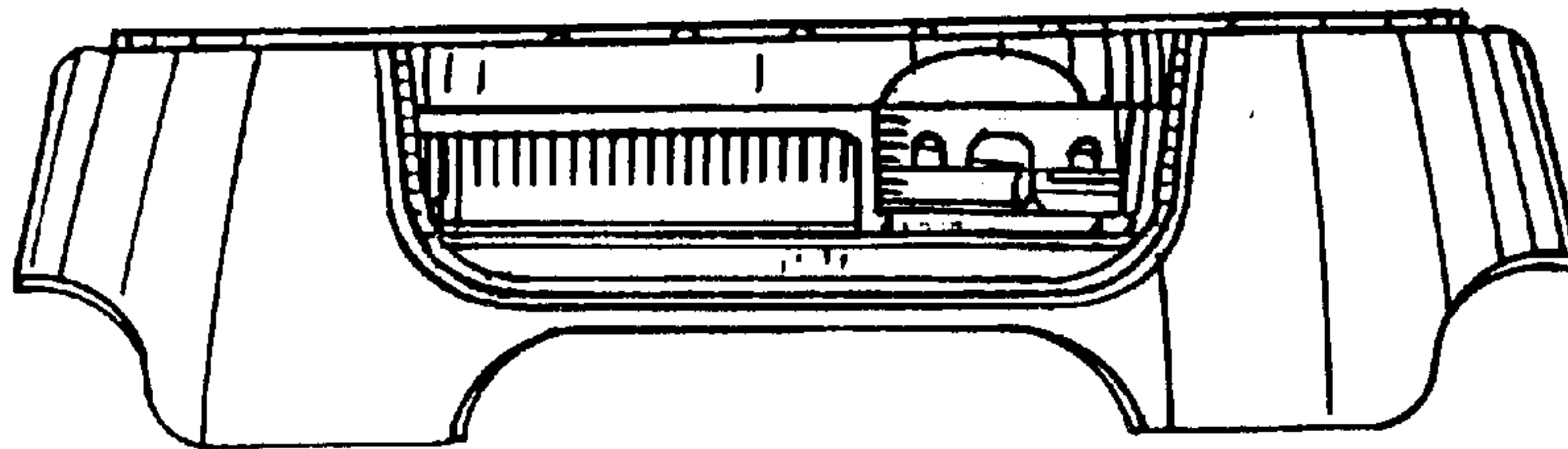

FIG-24

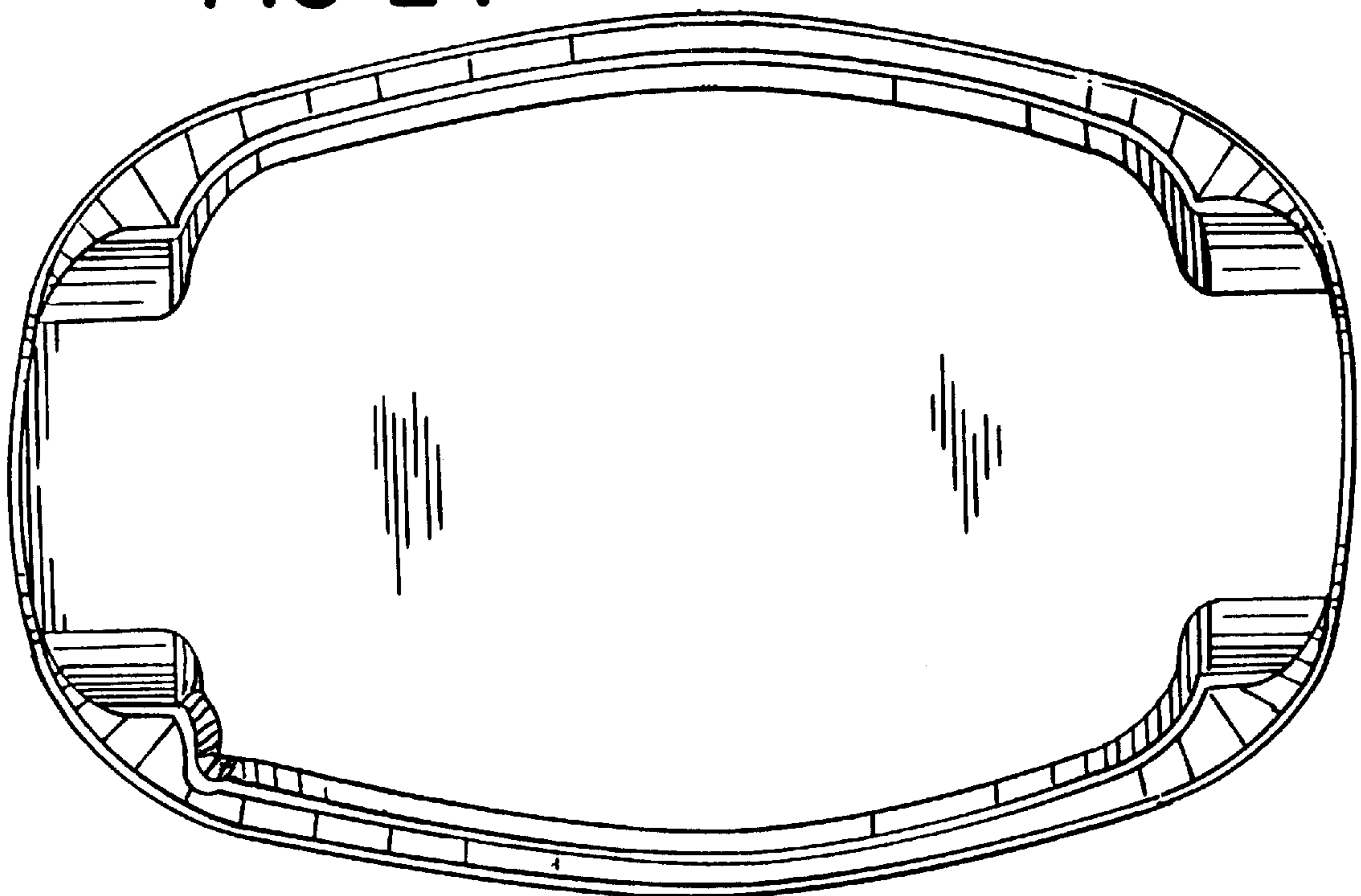

FIG-25

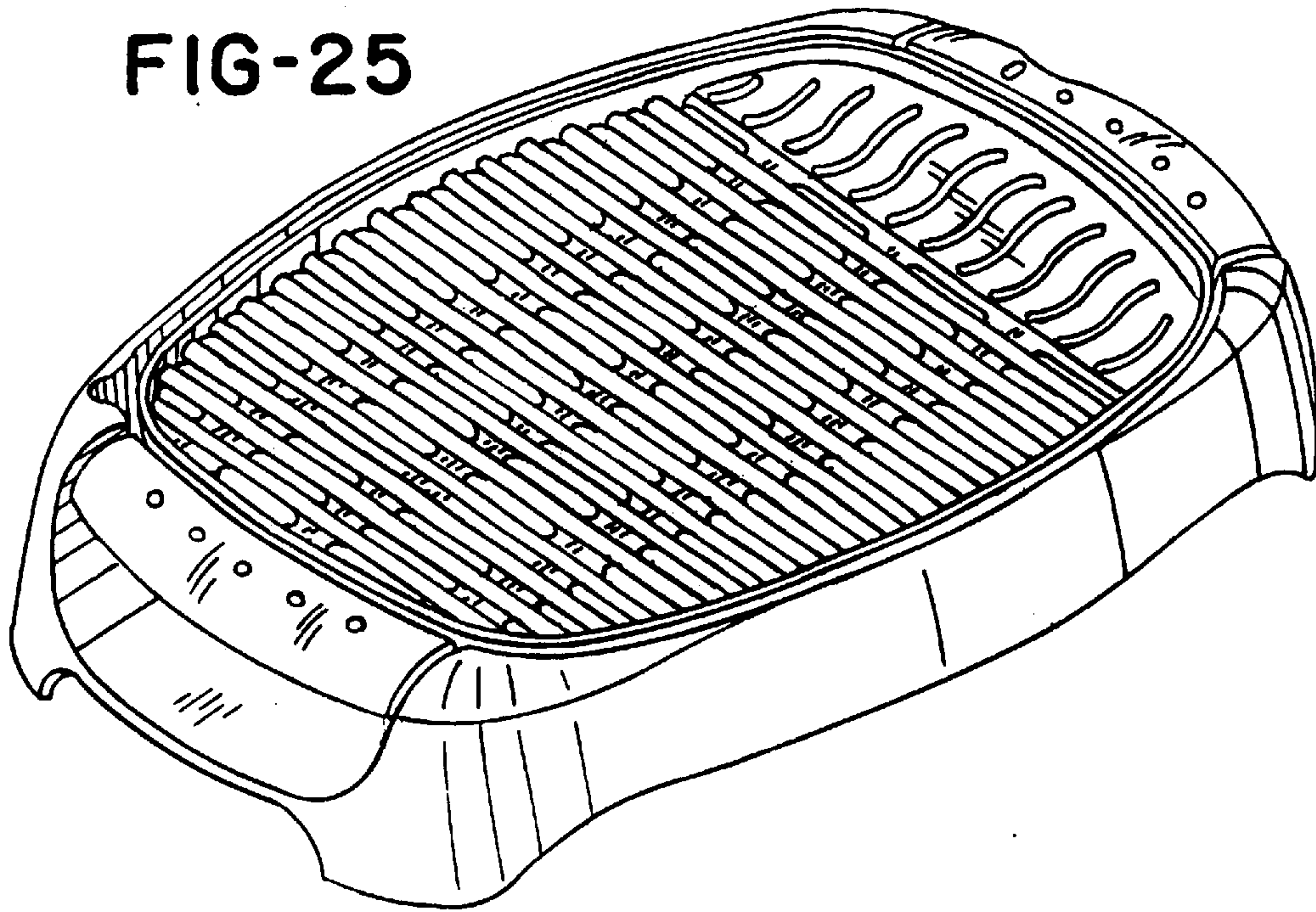

FIG-26

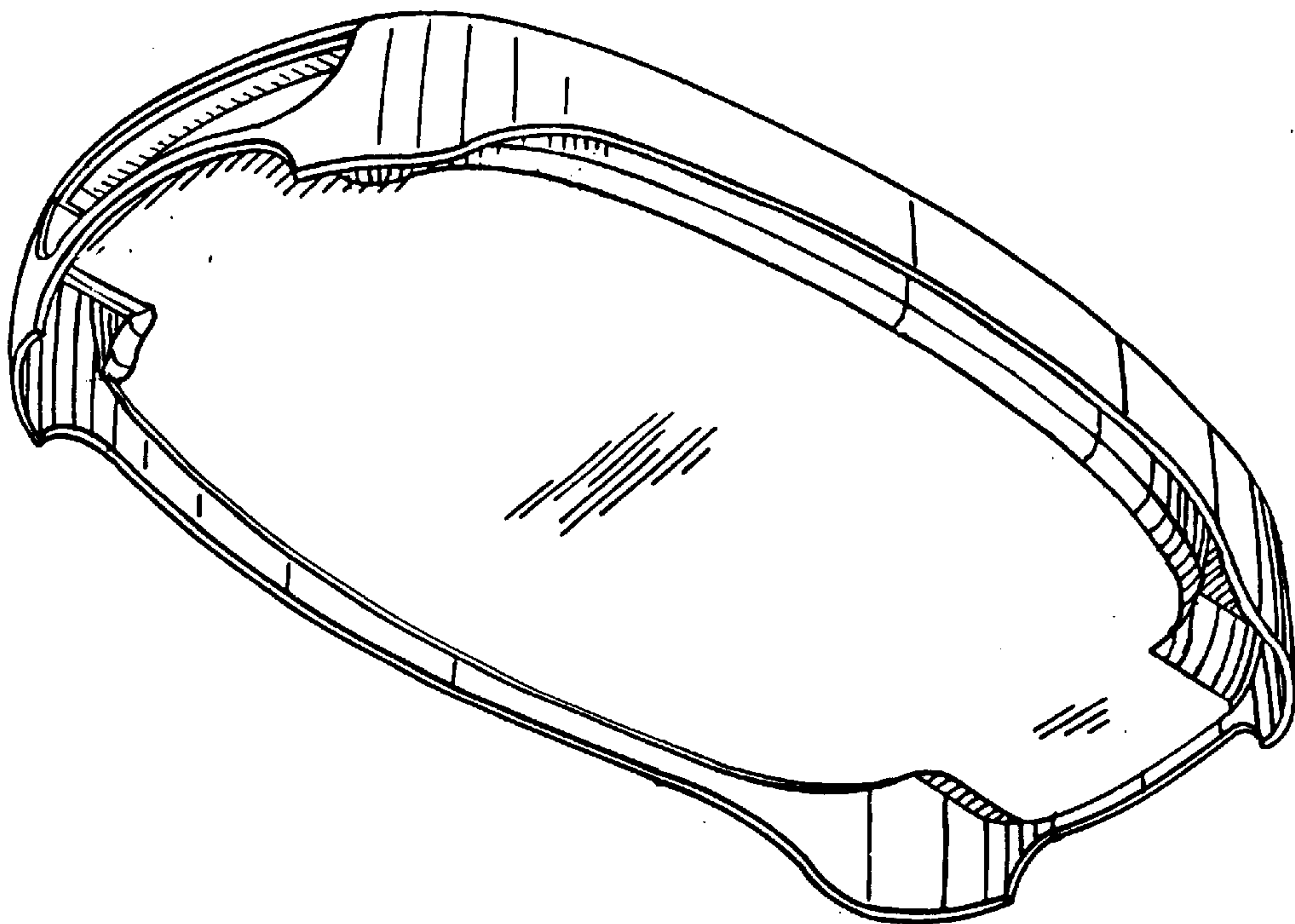

FIG-27

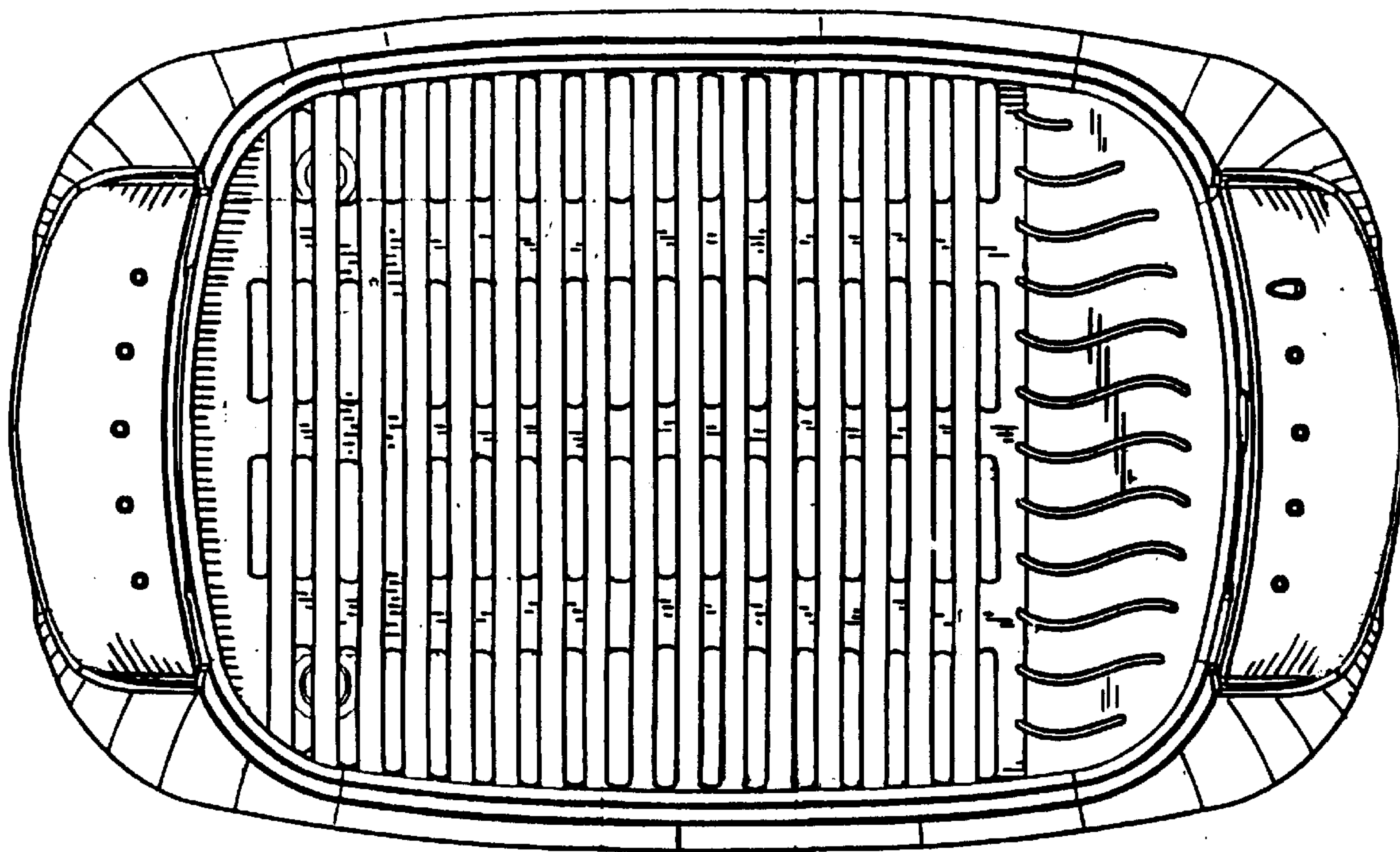

FIG-28

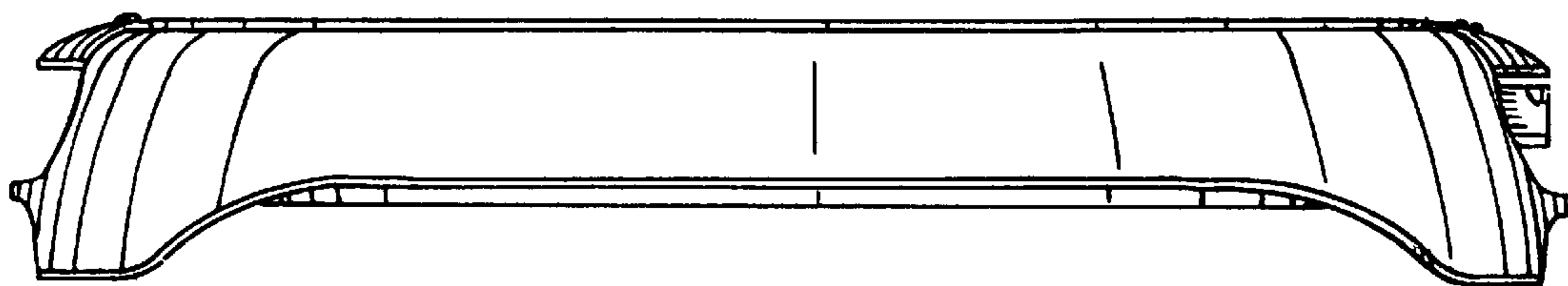

FIG-29

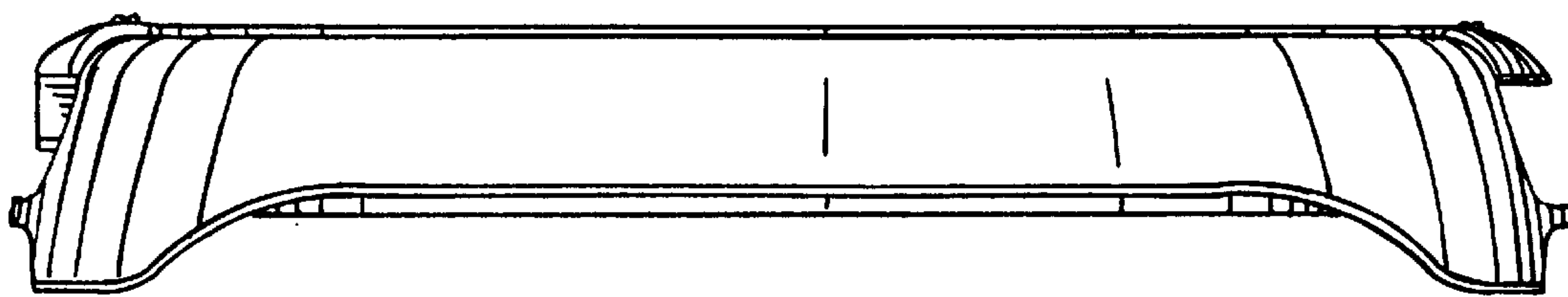

FIG-30

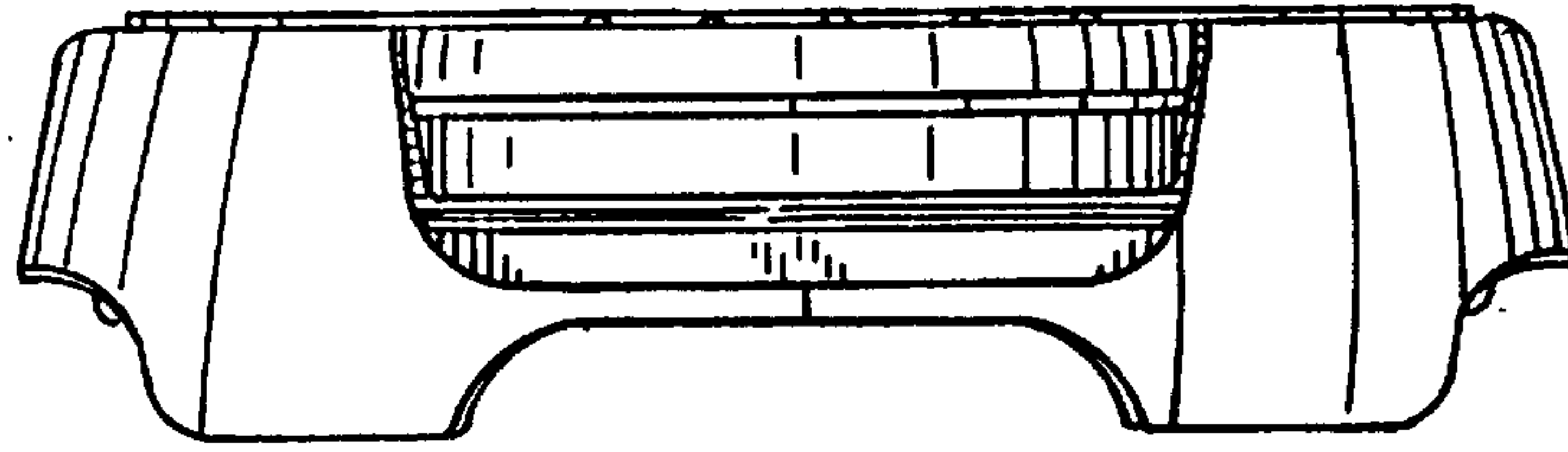

FIG-31

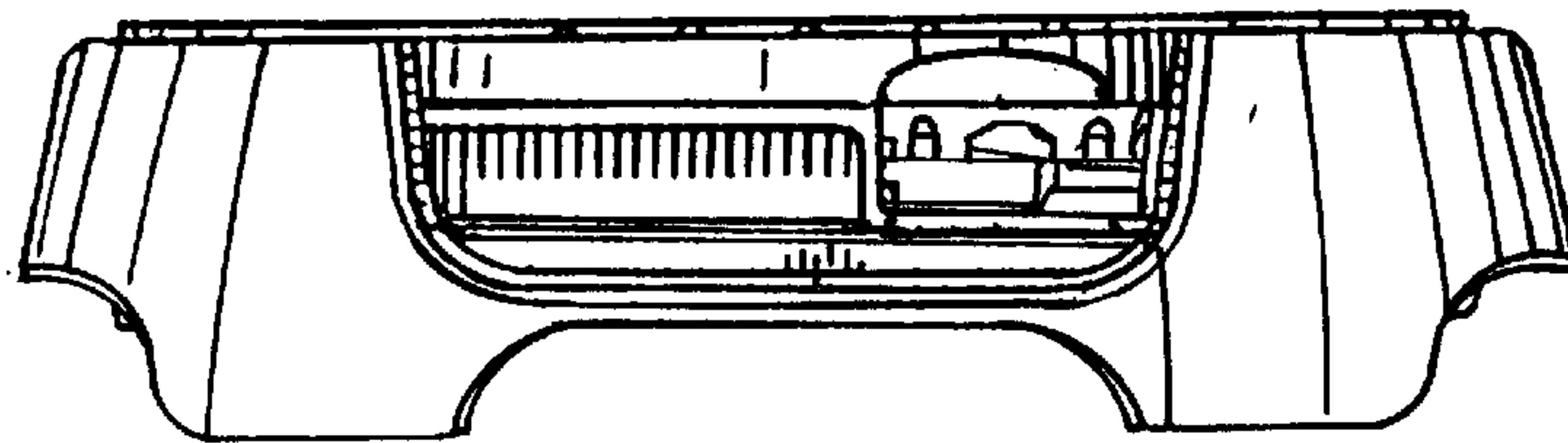

FIG-32

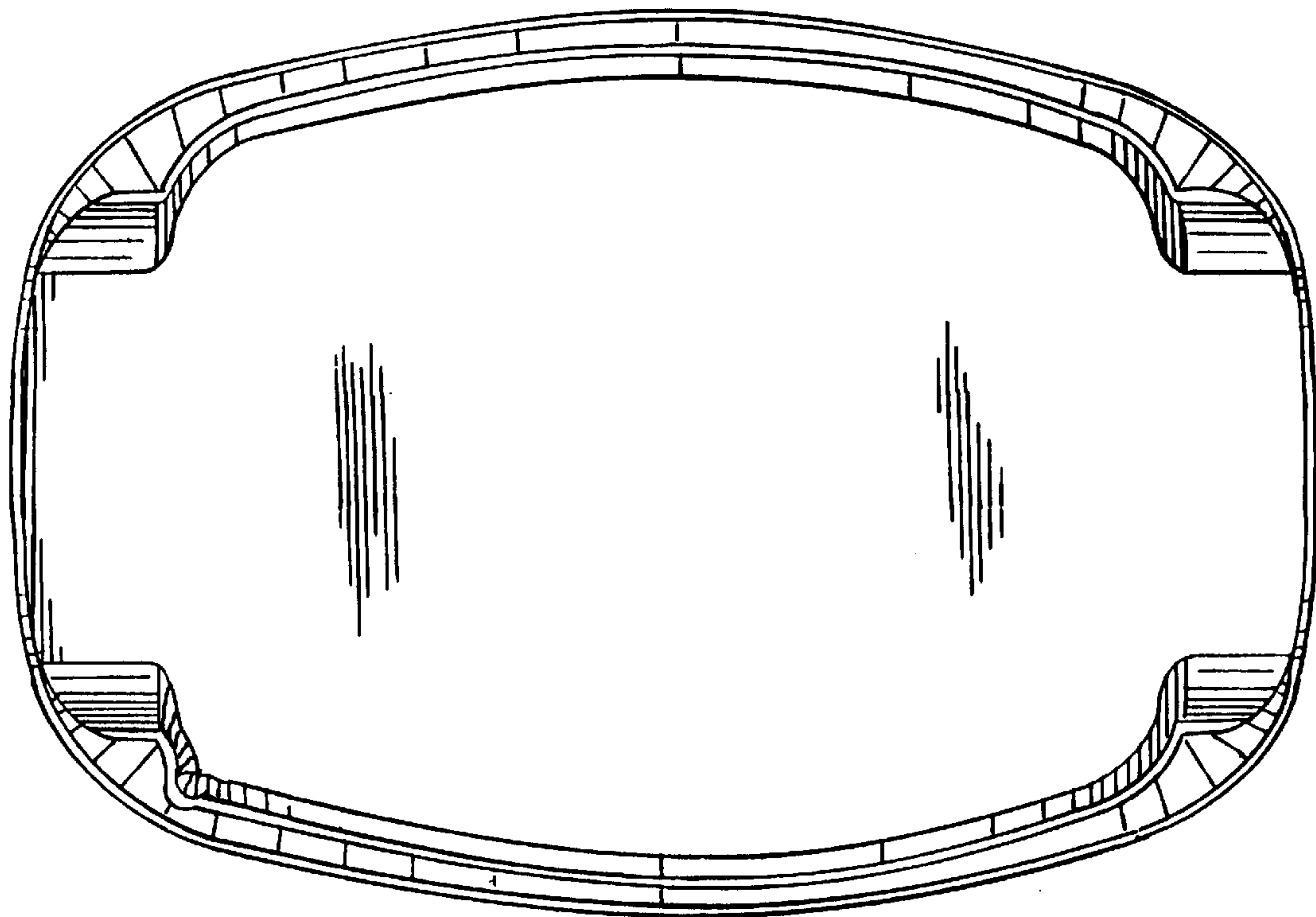

FIG-33

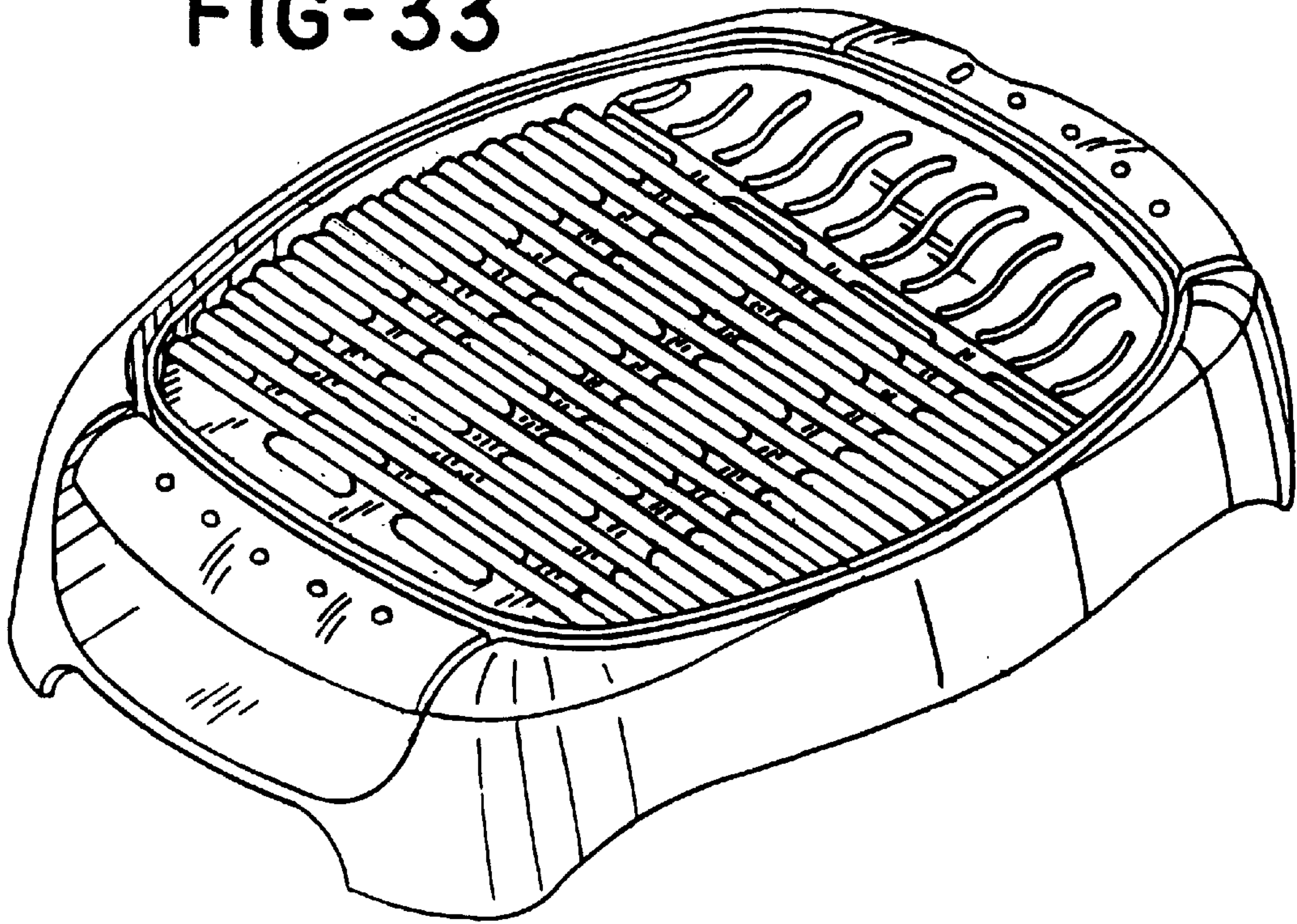

FIG-34

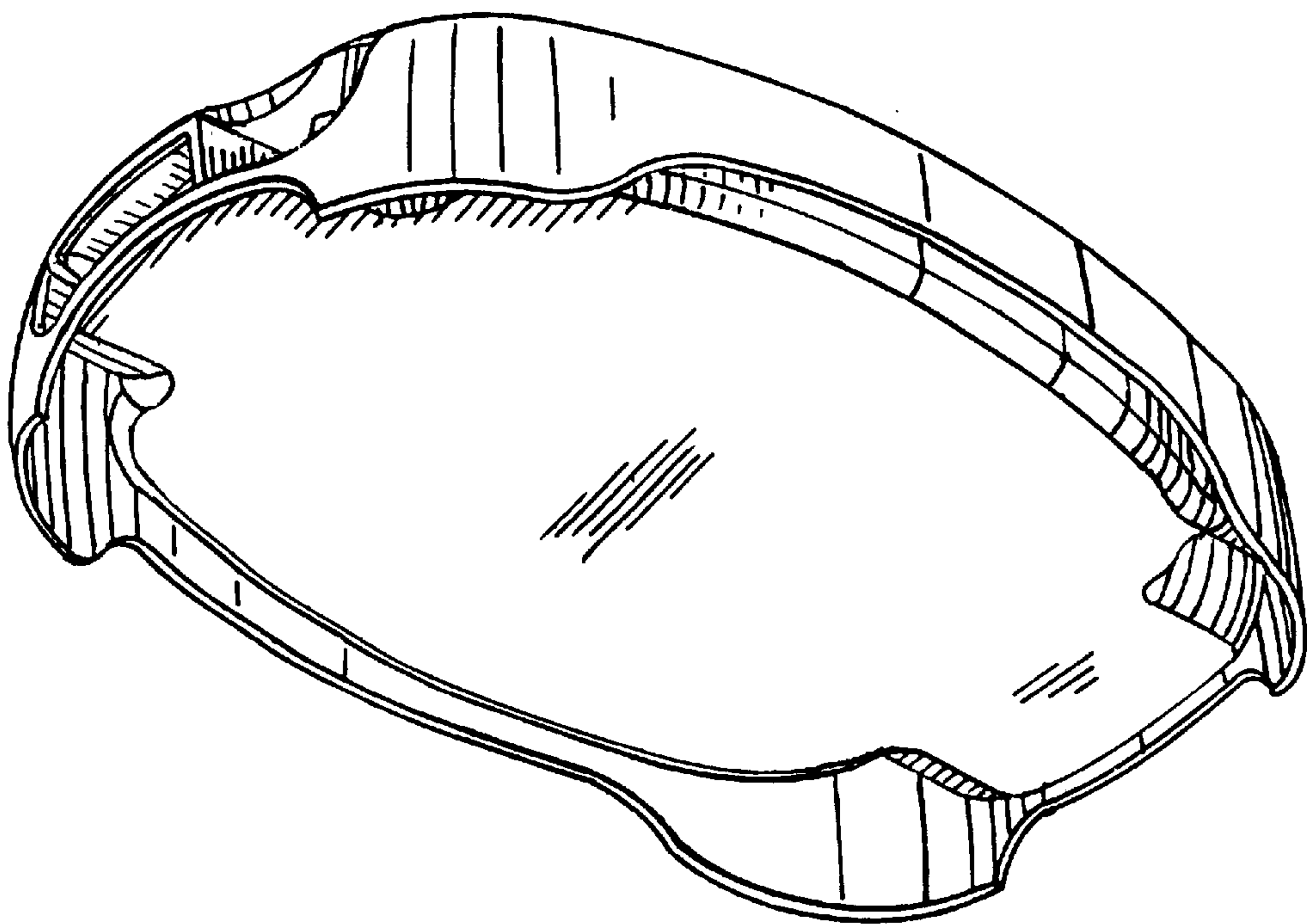

FIG-35

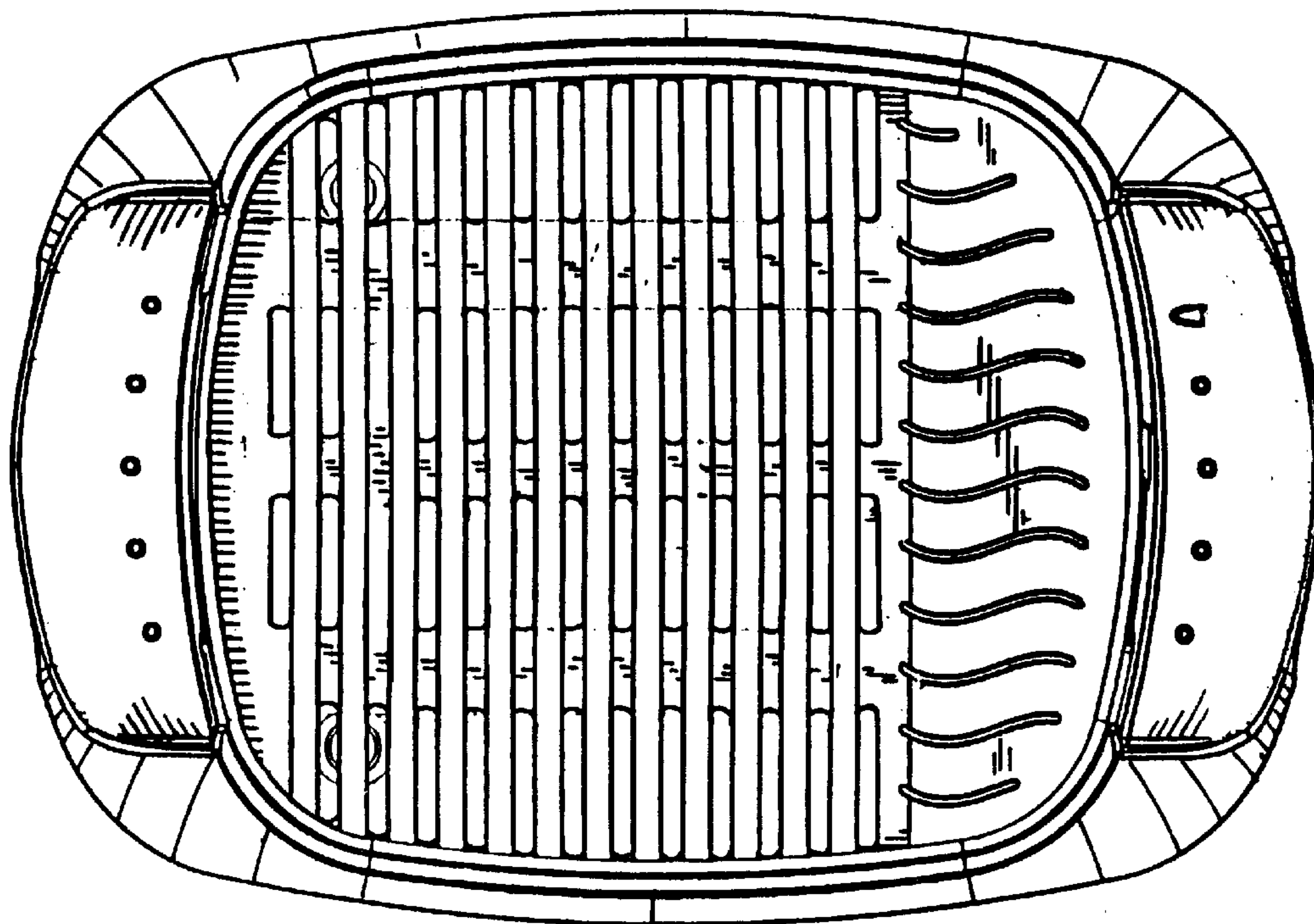

FIG-36

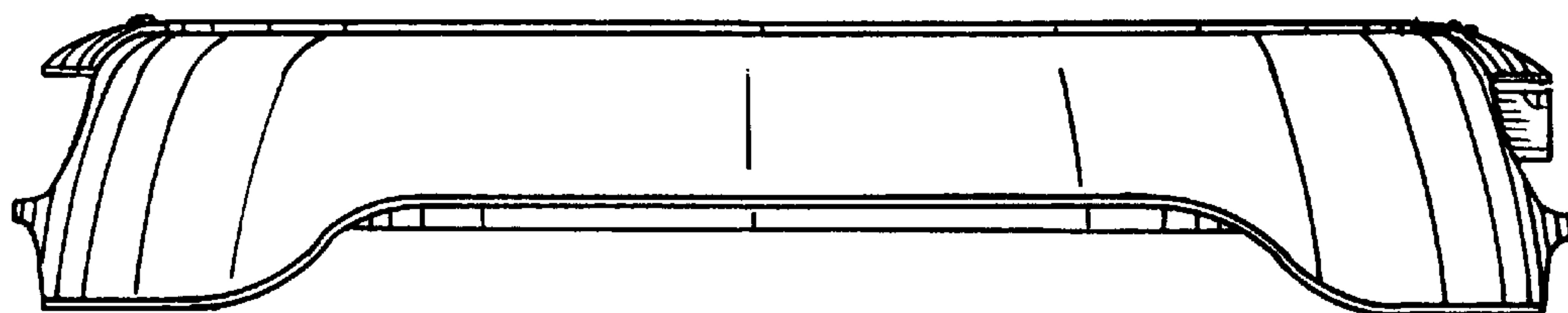

FIG-37

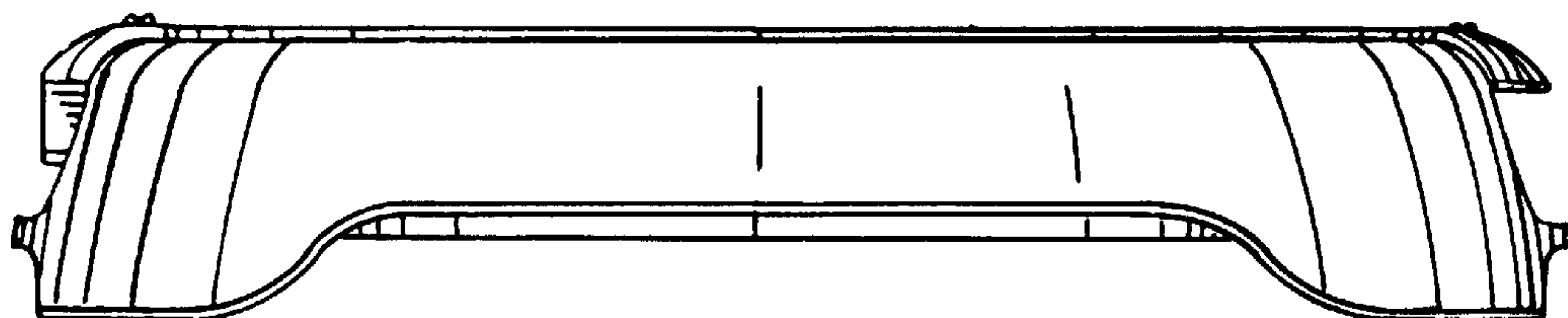

FIG-38

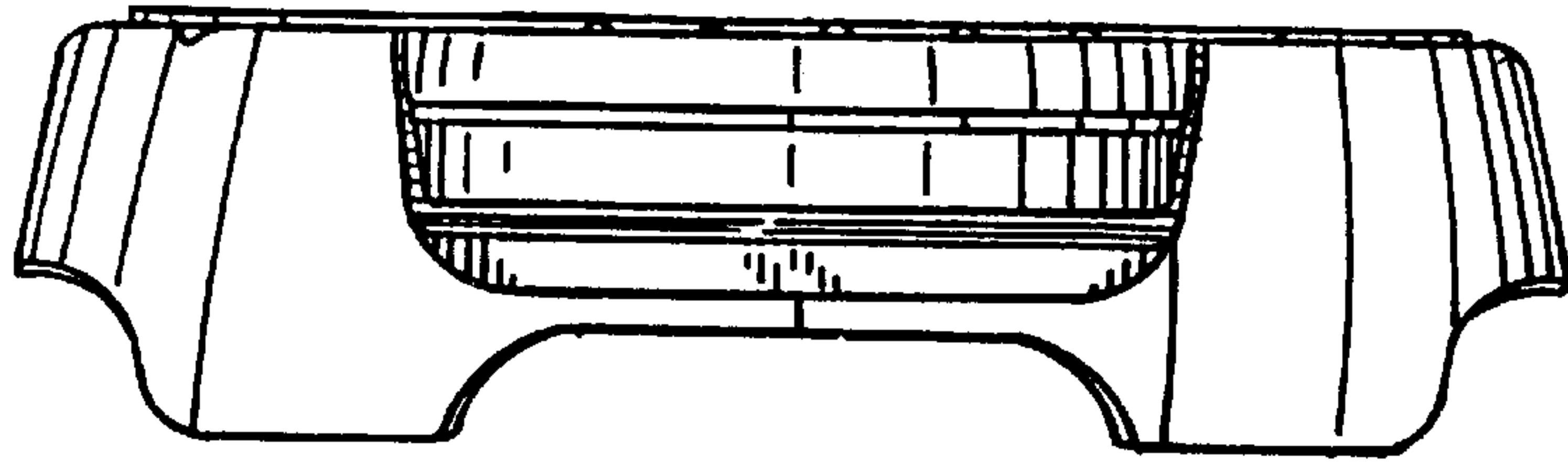

FIG-39

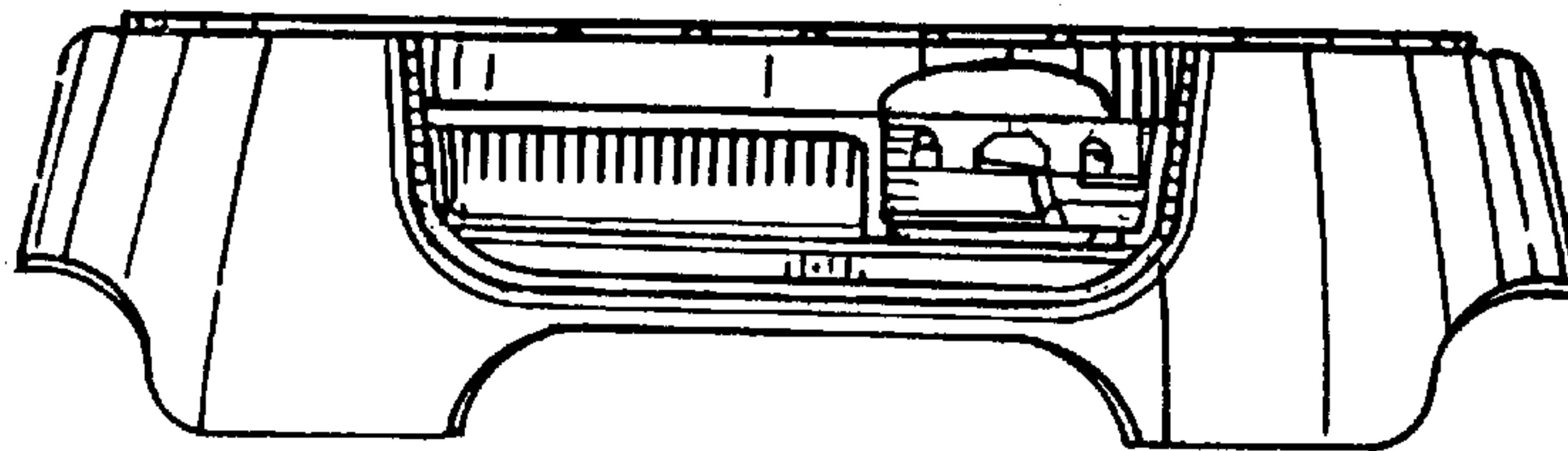

FIG-40

