



US00D473353S

(12) **United States Design Patent**
Neves

(10) **Patent No.:** **US D473,353 S**

(45) **Date of Patent:** **** Apr. 15, 2003**

(54) **COTTAGE SHAPED LITTER BOX WITH
REMOVABLE PEAK ROOF**

(76) **Inventor:** **Susan Diane Neves, P.O. Box 2631,
Rocklin, CA (US) 95677**

(**) **Term:** **14 Years**

(21) **Appl. No.:** **29/161,952**

(22) **Filed:** **Jun. 7, 2002**

Related U.S. Application Data

(63) Continuation-in-part of application No. 29/148,582, filed on
Sep. 21, 2001, now abandoned.

(51) **LOC (7) Cl.** **30-99**

(52) **U.S. Cl.** **D30/161**

(58) **Field of Search** D30/108-109,
D30/112-119, 158-161, 110-111; 119/161-170,
428-429, 431, 433, 482, 496-497, 500-502,
52.3, 57.8, 57.9, 453

(56) **References Cited**

U.S. PATENT DOCUMENTS

85,557 A	*	1/1869	Bent	119/482
D80,178 S	*	12/1929	Kidwell	D30/161
D104,059 S	*	4/1937	Bensel	D30/161
D134,429 S	*	11/1942	Steelman	D30/161
4,732,111 A	*	3/1988	Runion	119/165
D298,672 S	*	11/1988	Herbst	D30/161
D308,124 S	*	5/1990	Janzer	D30/112
D319,115 S	*	8/1991	White	D30/112
5,289,800 A	*	3/1994	Walton	119/166
D347,304 S	*	5/1994	Hellem	D30/161
5,396,864 A	*	3/1995	Mannschreck	119/168
D377,406 S	*	1/1997	McKinstry	D30/161

D377,549 S	*	1/1997	Long et al.	D30/161
D388,910 S	*	1/1998	Willinger et al.	D30/161
5,964,190 A	*	10/1999	Willinger et al.	119/500
D420,470 S	*	2/2000	Kolozsvari et al.	D30/108
D425,674 S	*	5/2000	Dykens	D30/112
D432,593 S	*	10/2000	Naughton	D30/110

* cited by examiner

Primary Examiner—Cathy Anne MacCormac

(74) *Attorney, Agent, or Firm*—Mark C. Jacobs

(57) **CLAIM**

The ornamental design for a cottage shaped litter box with
removable peak roof, as shown and described.

DESCRIPTION

FIG. 1 is a perspective view of the first embodiment;
 FIG. 2 is a front view thereof;
 FIG. 3 is a left side view thereof, the right side is a mirror
 image;
 FIG. 4 is a top plan view thereof;
 FIG. 5 is a rear view thereof;
 FIG. 6 is a bottom plan view thereof;
 FIG. 7 is a front elevational view of the roof, the rear
 elevational view being a mirror image;
 FIG. 8 is a bottom perspective inside view of the roof;
 FIG. 9 is a bottom plan view of the roof;
 FIG. 10 is a top perspective view thereof without the roof;
 FIG. 11 is the top plan view of FIG. 10;
 FIG. 12 is a front and left perspective view of a second
 embodiment;
 FIG. 13 is a right side view of the second embodiment;
 FIG. 14 is a top plan view of FIG. 12; and,
 FIG. 15 is a side view of a third embodiment.

1 Claim, 5 Drawing Sheets

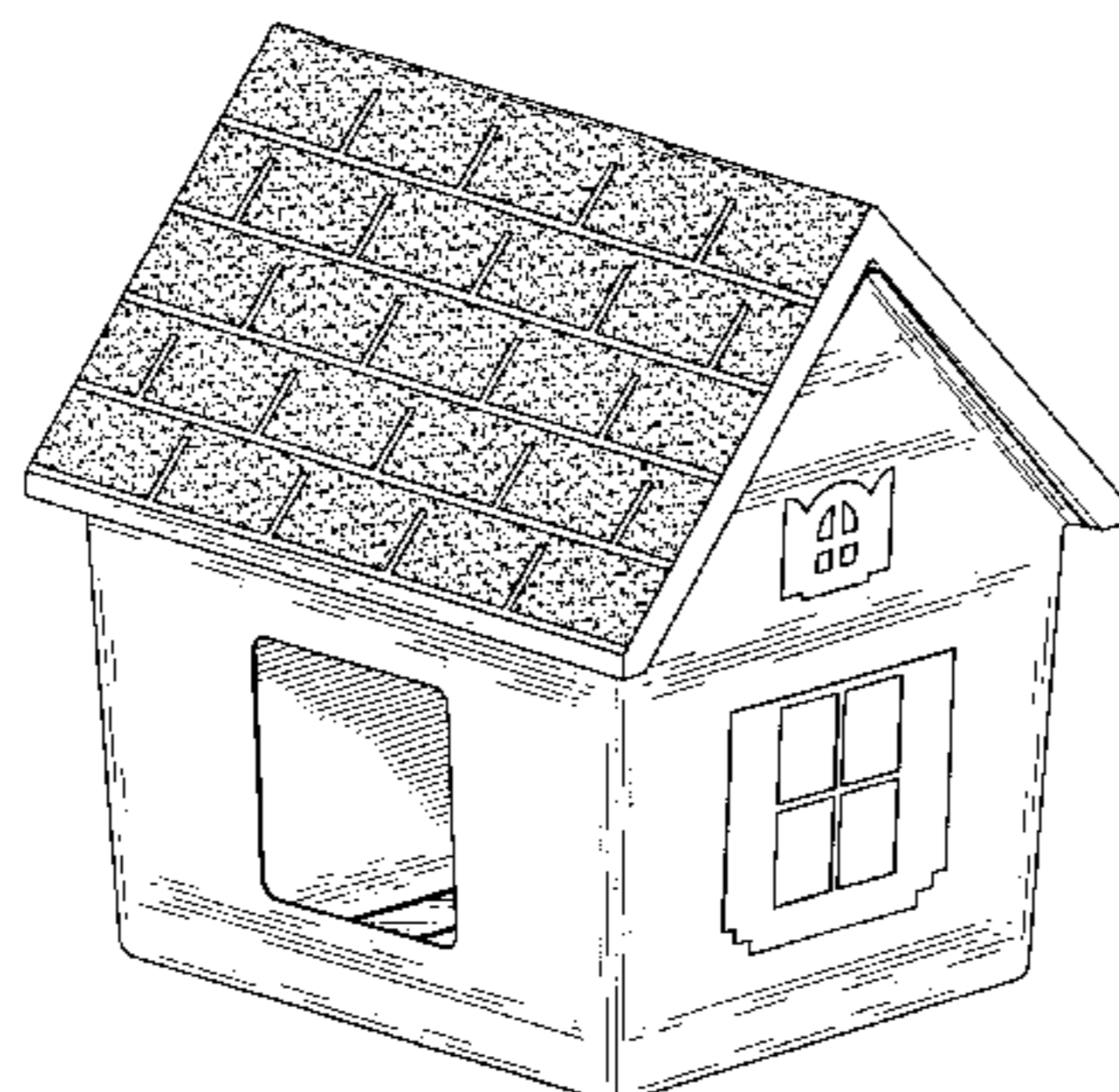
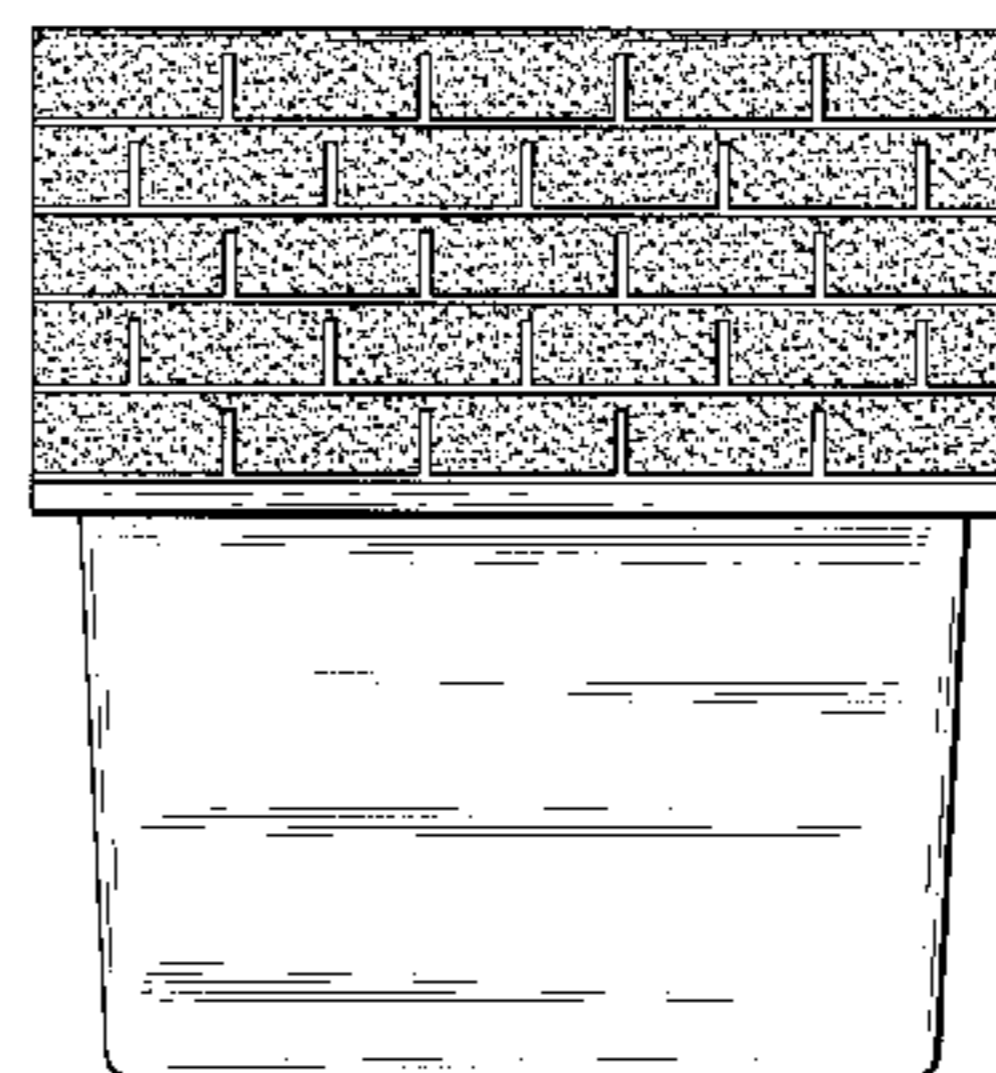
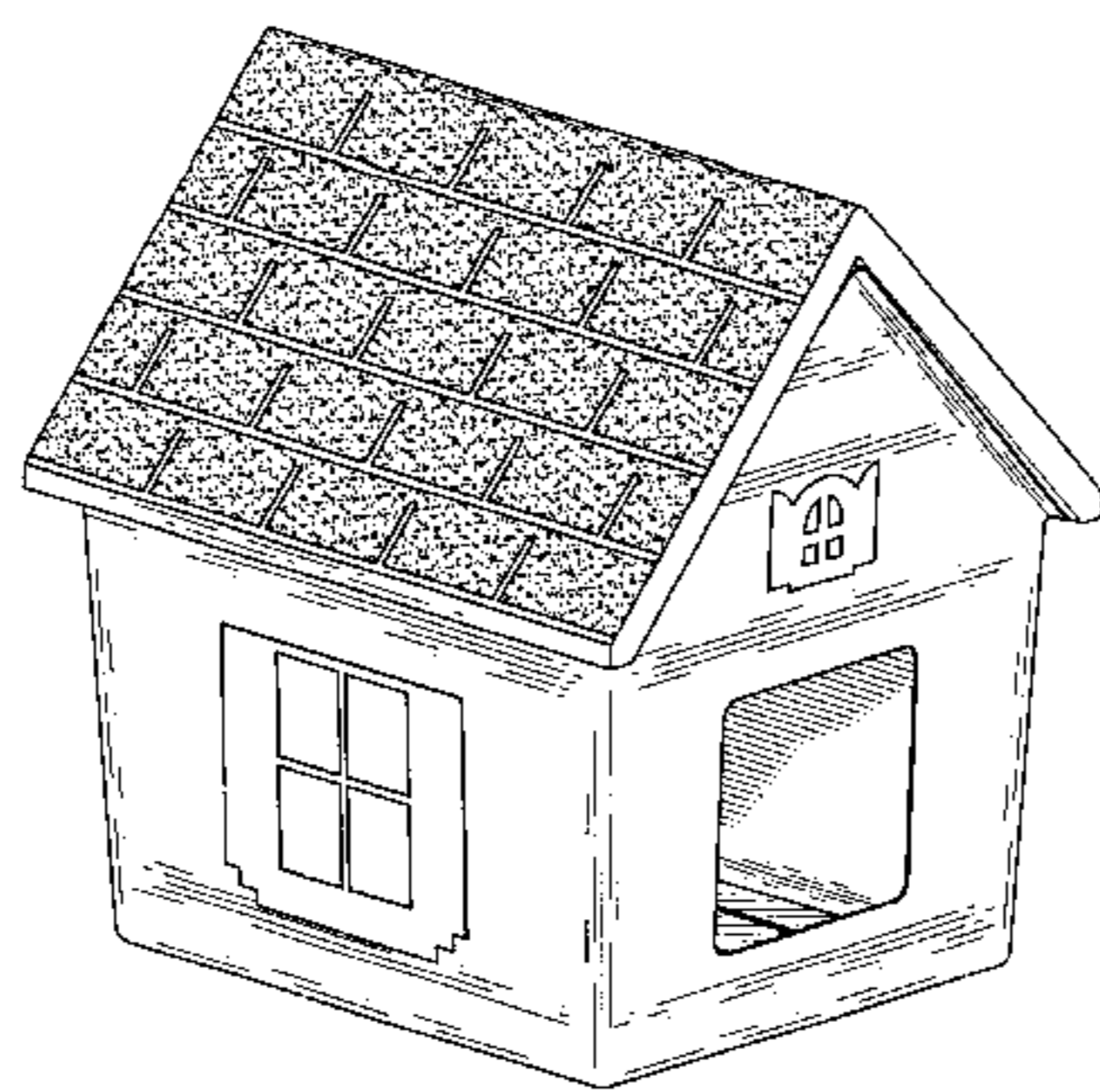

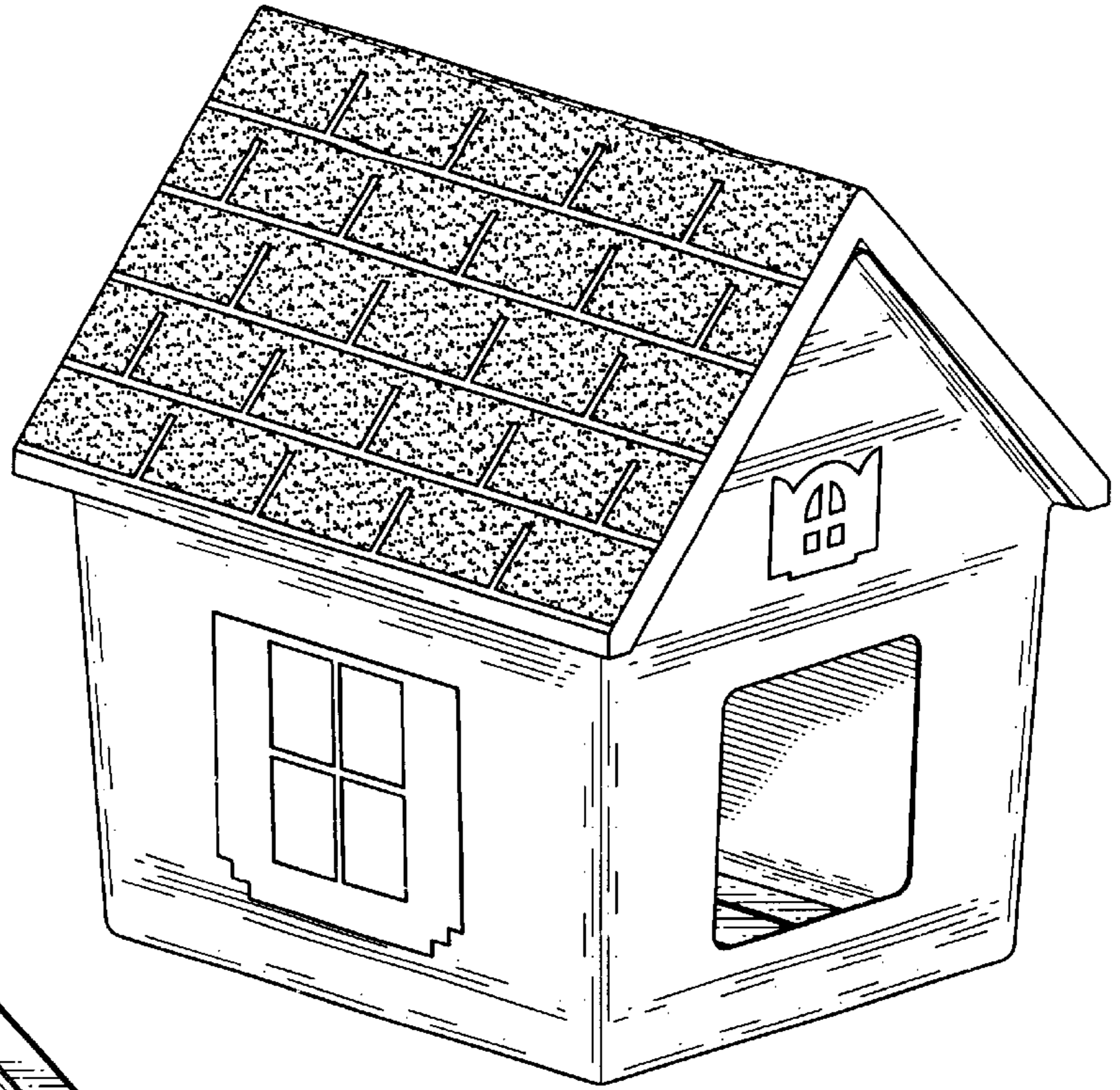

Fig. 1

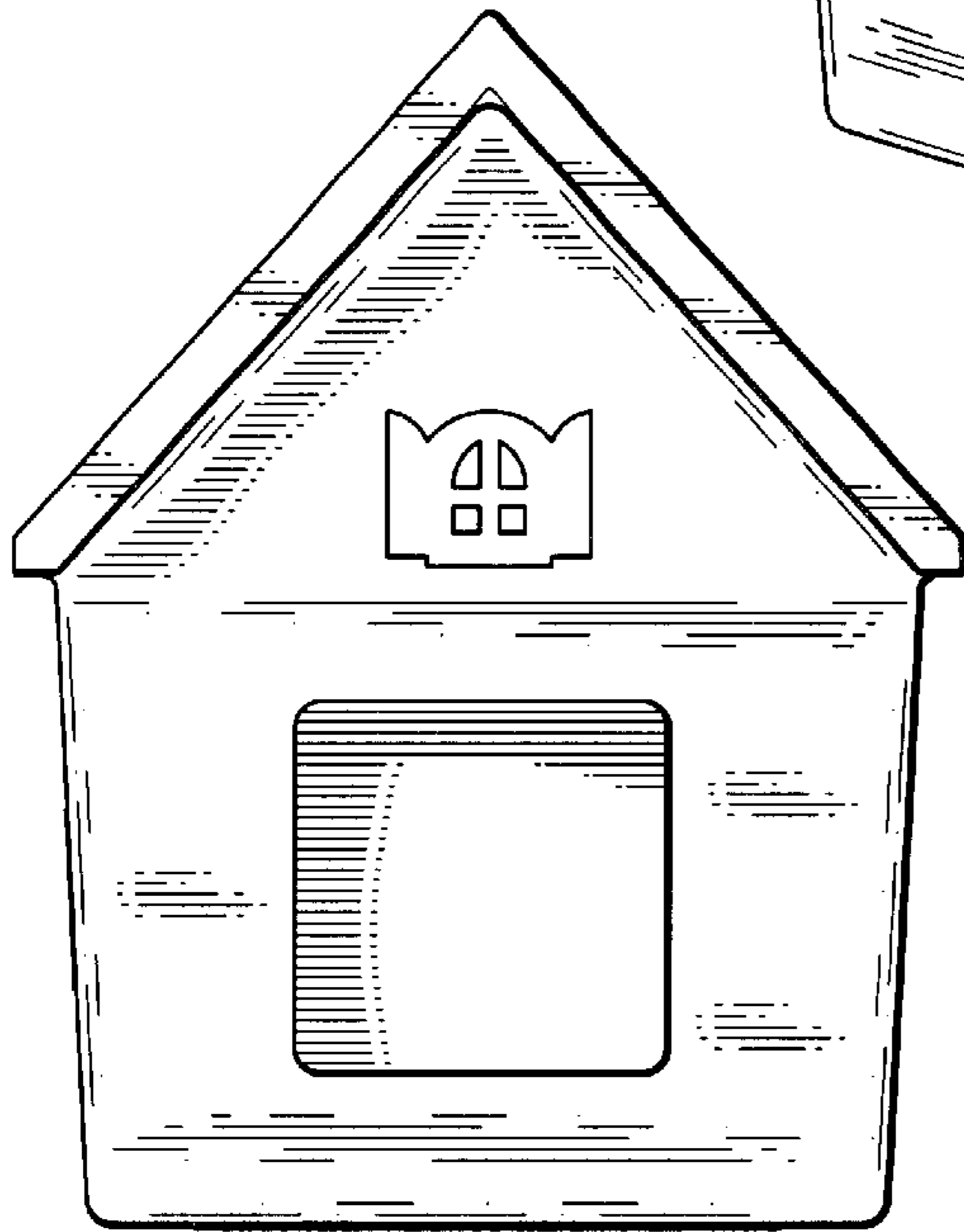

Fig. 2

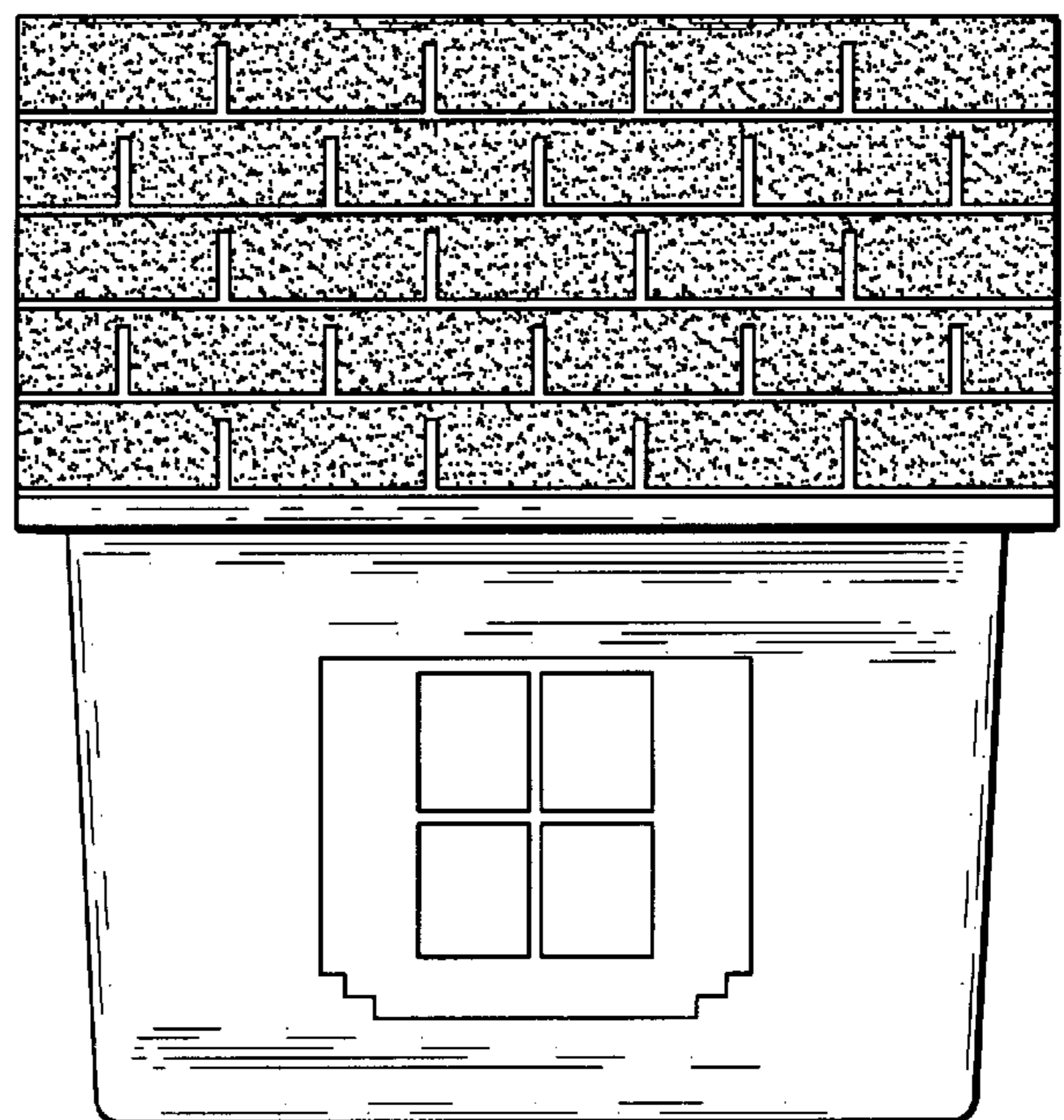

Fig. 3

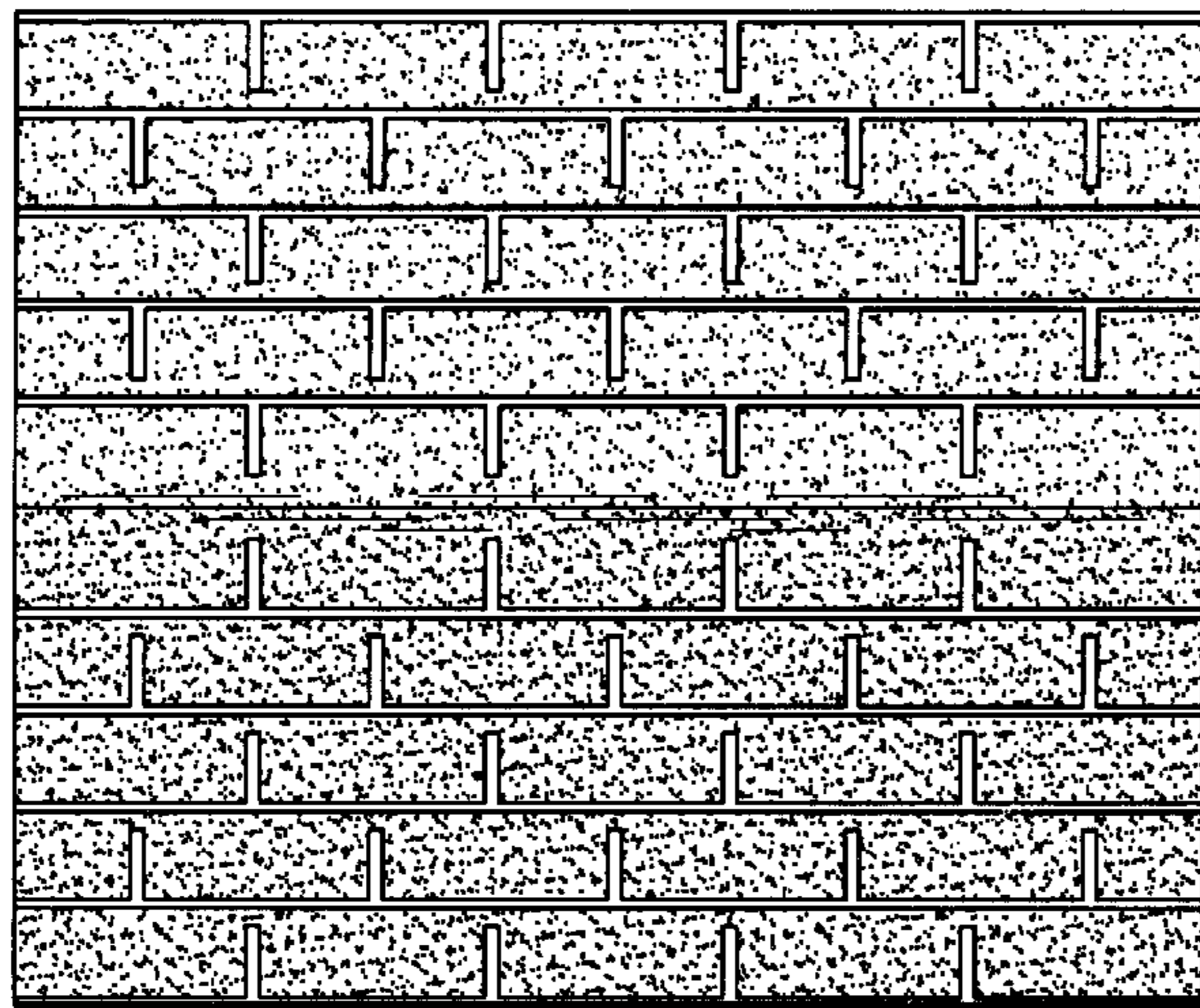

Fig. 4

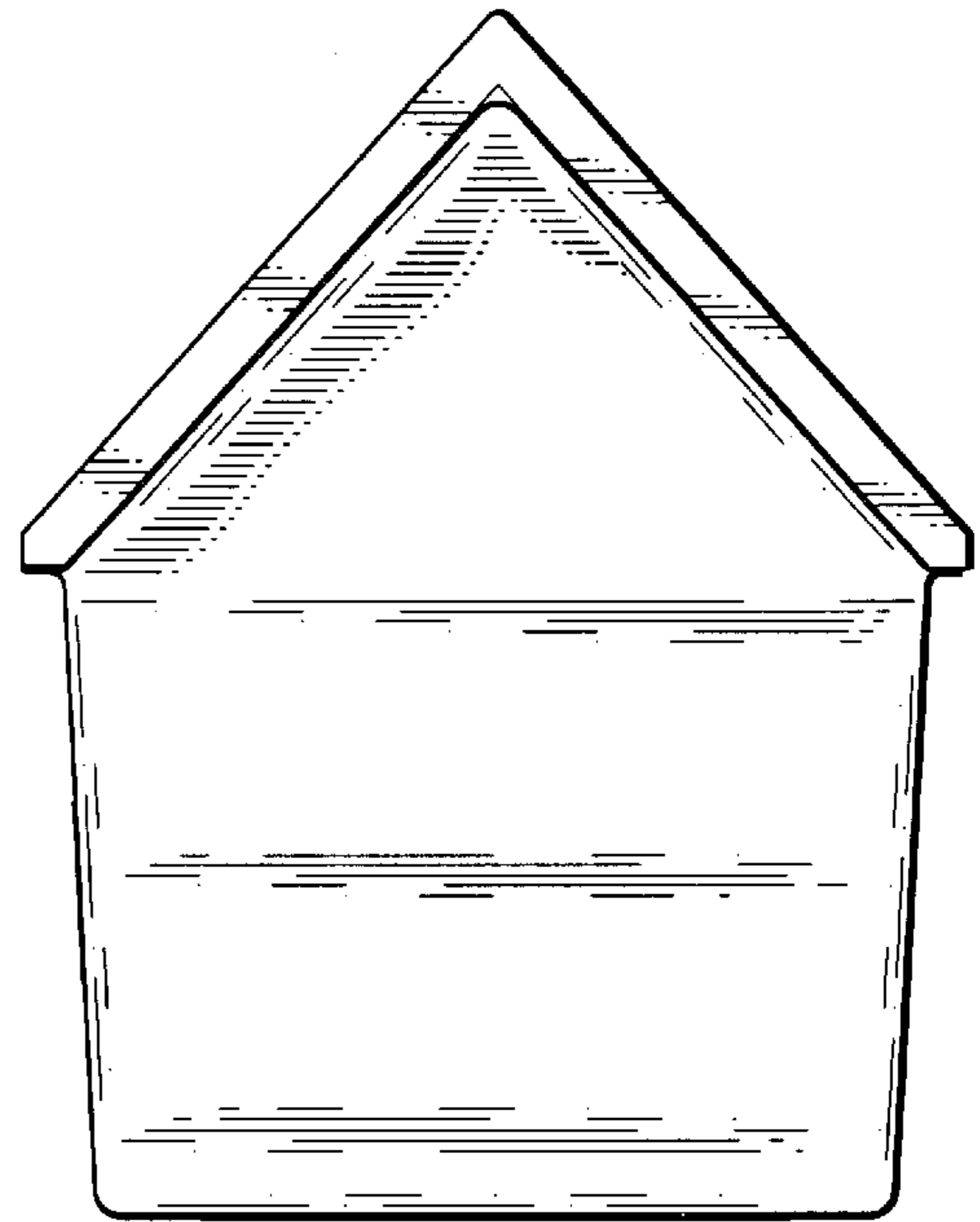

Fig. 5

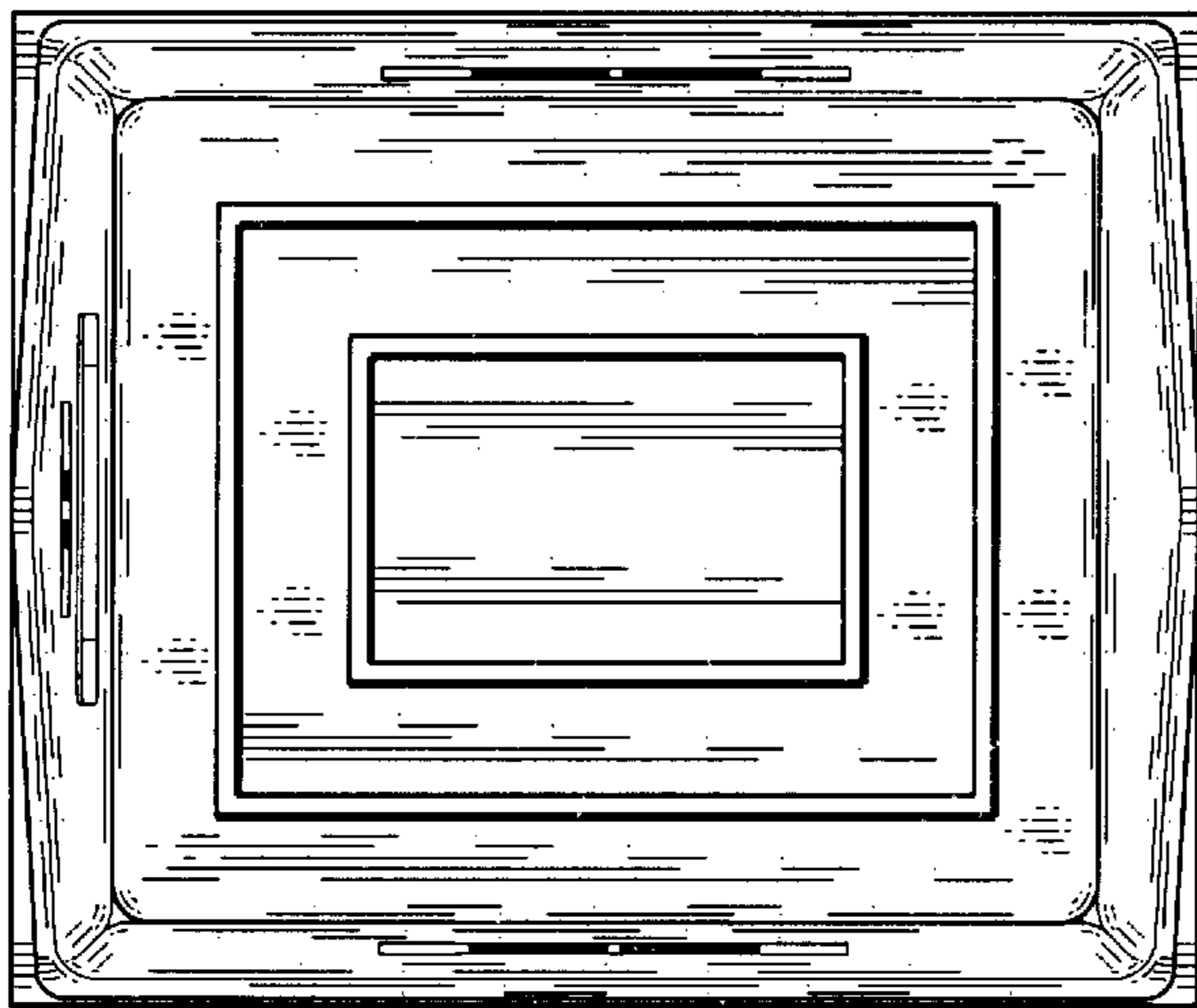

Fig. 6

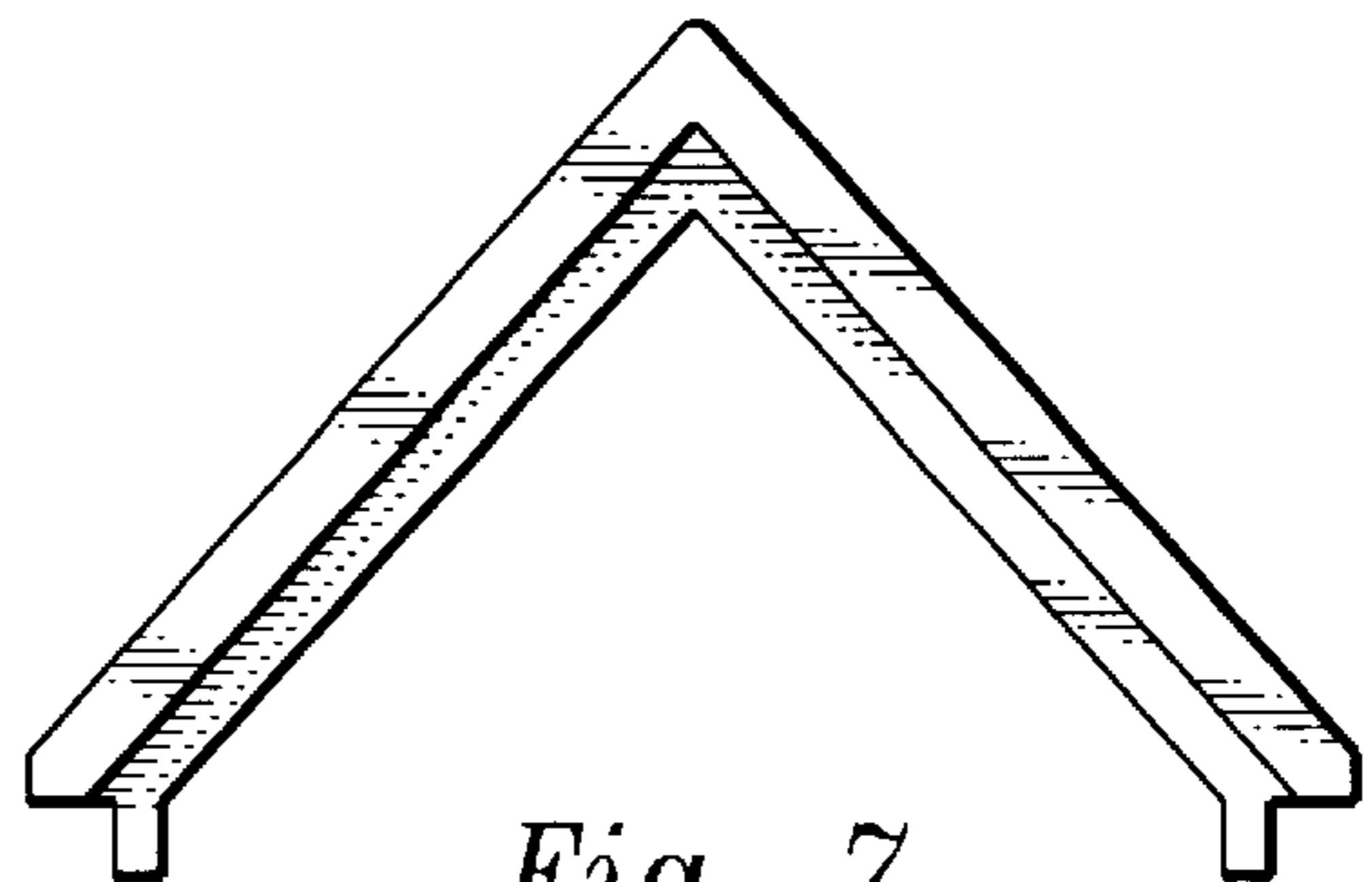

Fig. 7

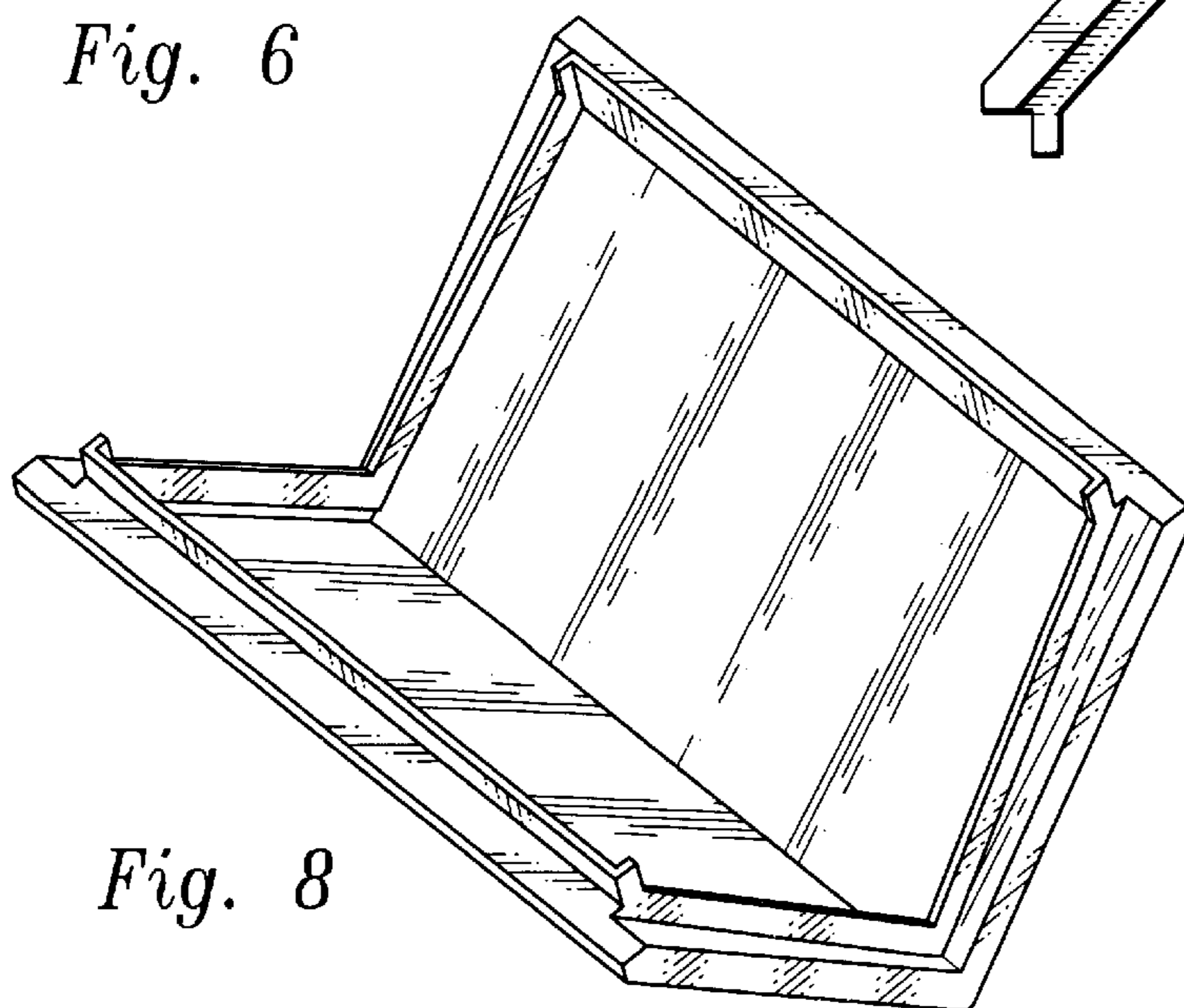

Fig. 8

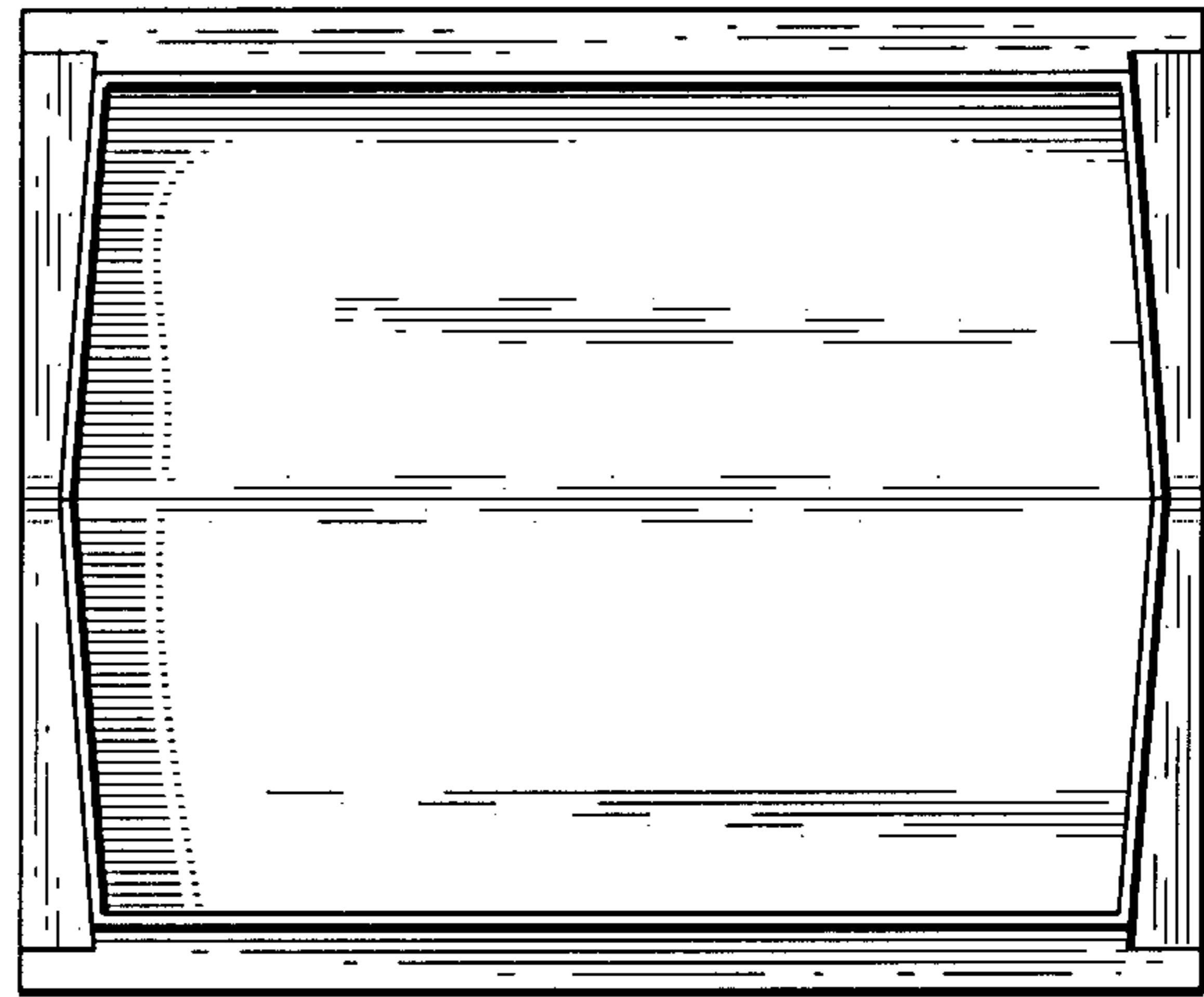

Fig. 9

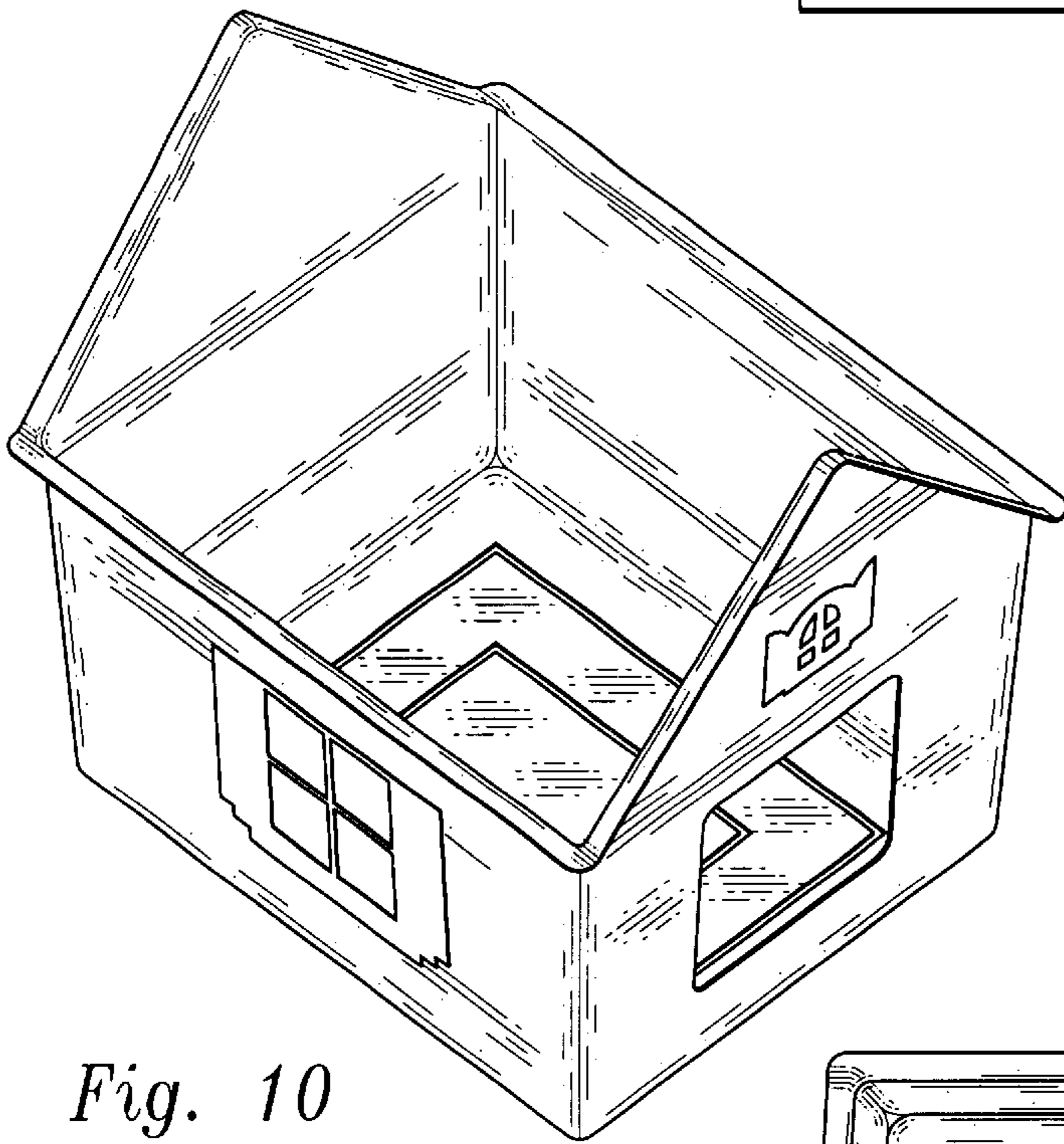

Fig. 10

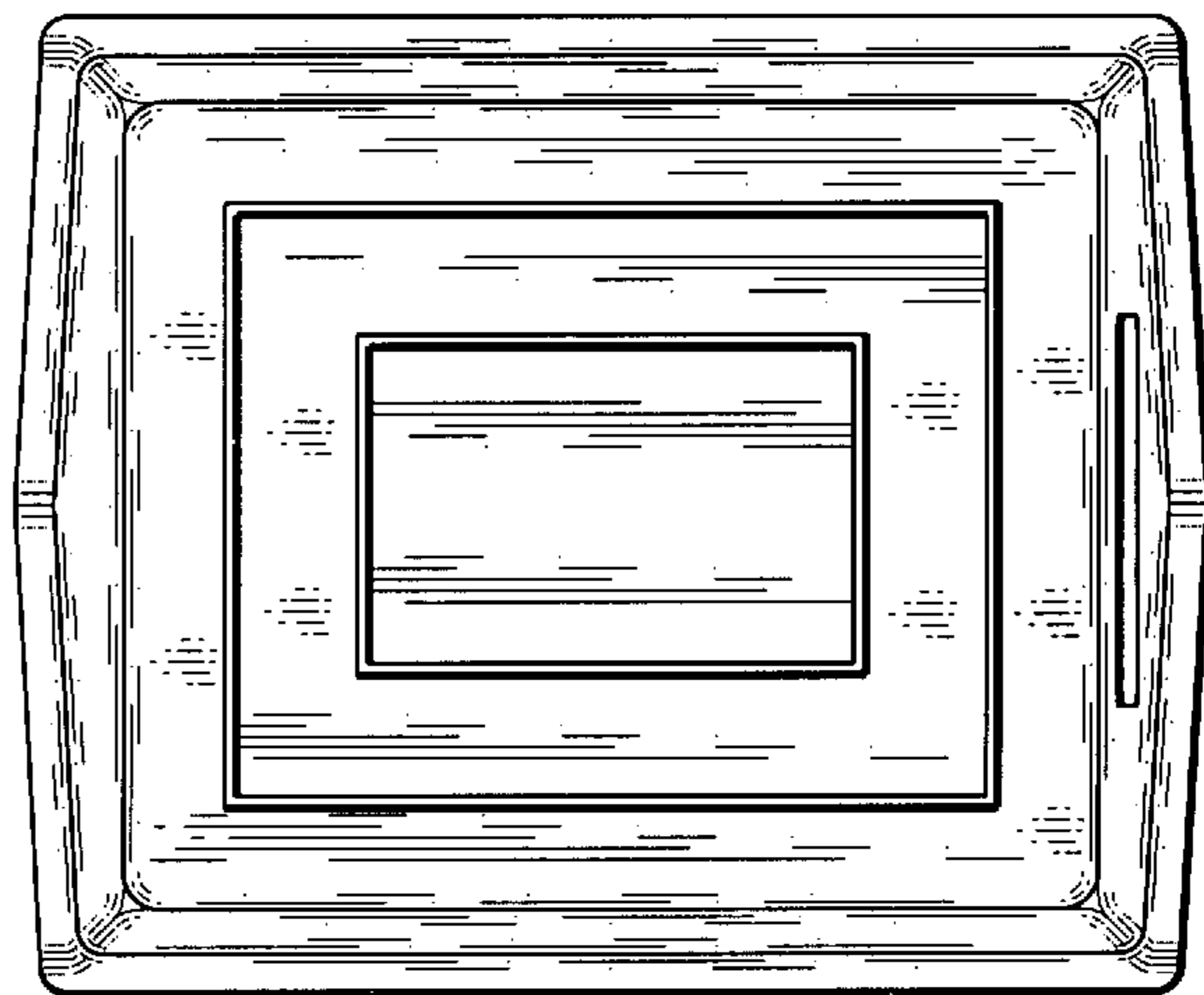

Fig. 11

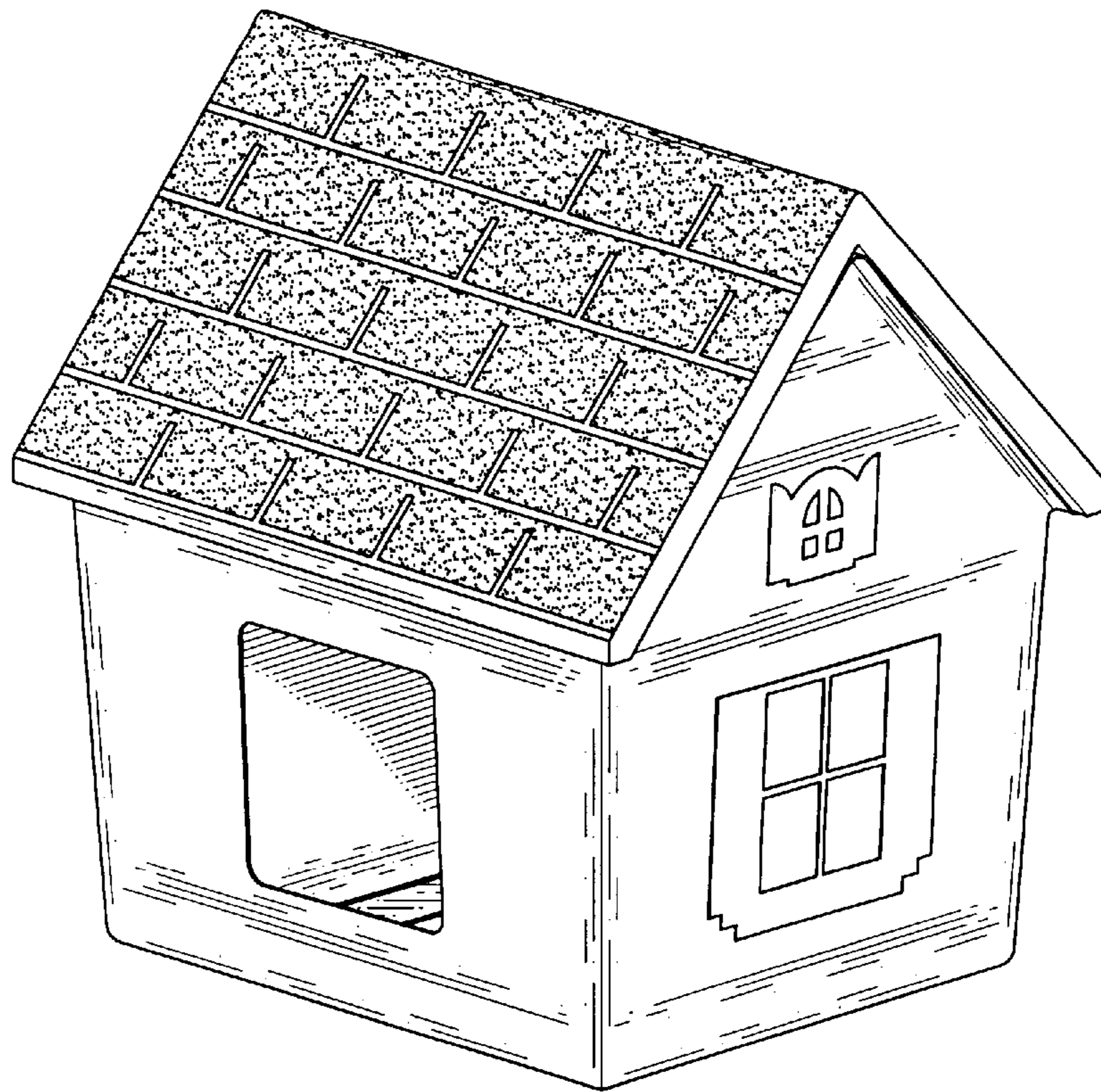

Fig. 12

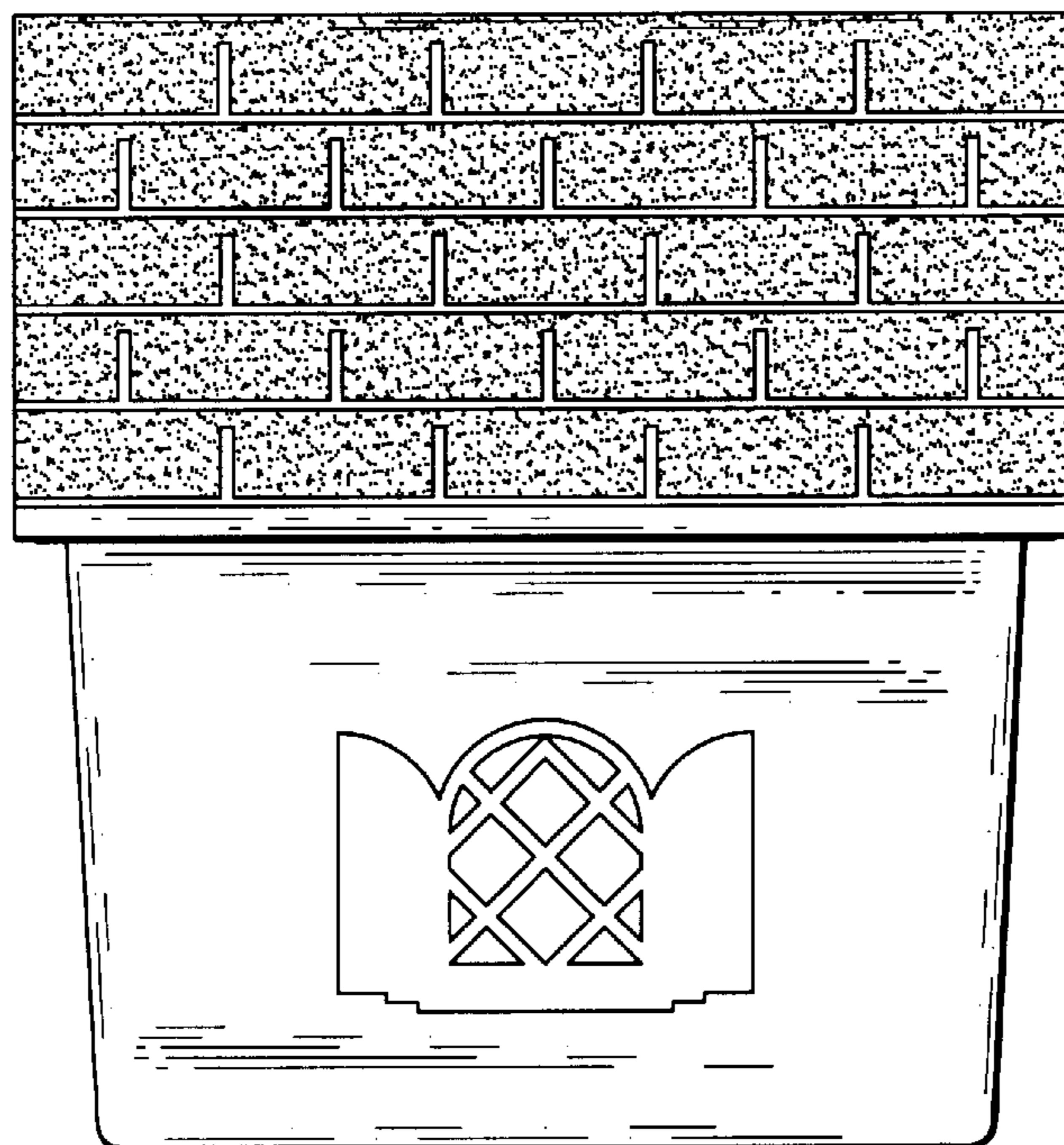

Fig. 15

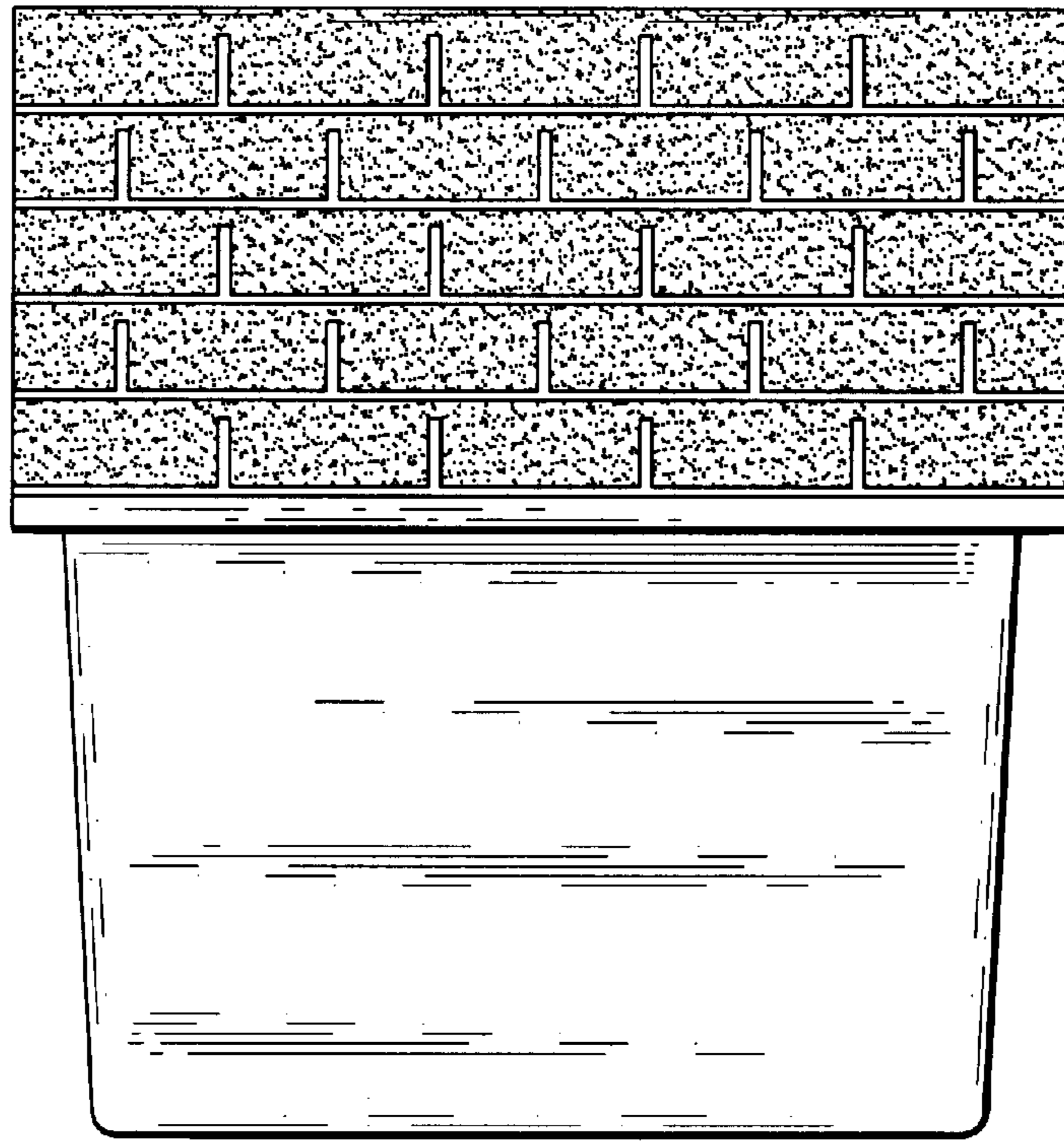

Fig. 13

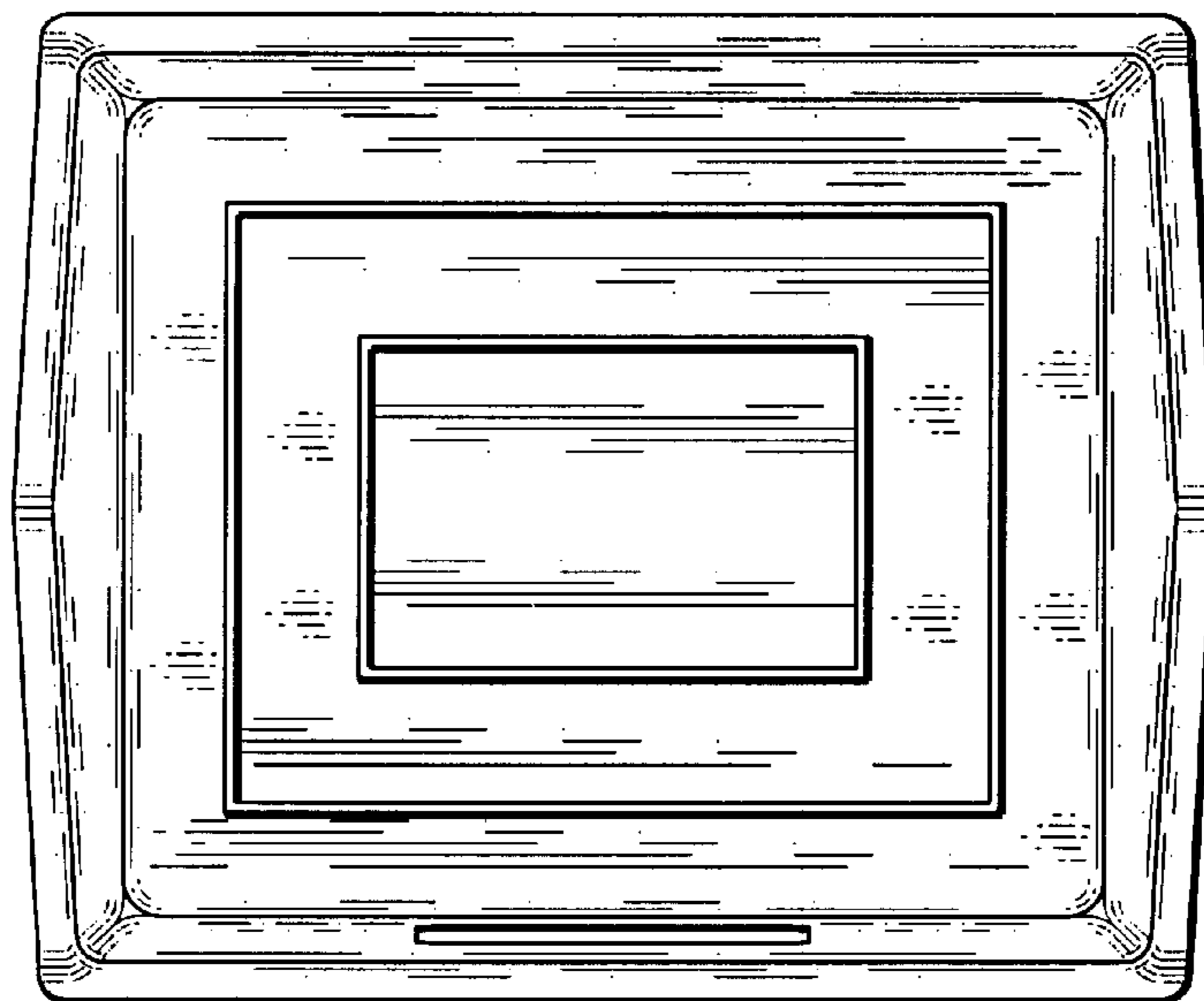

Fig. 14