



US00D473352S

(12) **United States Design Patent**
Neves

(10) **Patent No.:** **US D473,352 S**

(45) **Date of Patent:** **** Apr. 15, 2003**

(54) **BARN SHAPED LITTER BOX WITH
REMOVABLE FLAT ROOF**

(76) **Inventor:** **Susan Diane Neves**, P.O. Box 2631,
Rocklin, CA (US) 95677

(**) **Term:** **14 Years**

(21) **Appl. No.:** **29/156,678**

(22) **Filed:** **Mar. 6, 2002**

(51) **LOC (7) Cl.** **30-99**

(52) **U.S. Cl.** **D30/161**

(58) **Field of Search** D30/108-109,
D30/112-119, 158-160, 161, 110-111;
119/428-429, 431, 433, 482, 496-497,
499, 500-502, 52.3, 57.8, 57.9, 453, 161-170

(56) **References Cited**

U.S. PATENT DOCUMENTS

1,754,590	A	*	5/1930	Allen	119/482
3,428,026	A	*	2/1969	Sohmers et al.	119/482
D228,558	S	*	10/1973	Brickel	D30/161
3,793,989	A	*	2/1974	Clark	119/165
D248,879	S	*	8/1978	Hill	D30/112
4,732,111	A	*	3/1988	Runion	119/165
D298,672	S	*	11/1988	Herbst	D30/161
4,803,952	A	*	2/1989	Houser	119/499
D319,115	S	*	8/1991	White	D30/112
D334,634	S	*	4/1993	Greitzer	D30/108
5,383,422	A	*	1/1995	Morris	119/168
5,464,686	A	*	11/1995	Higashi et al.	119/168
5,582,135	A	*	12/1996	Bellows	119/168
D377,549	S	*	1/1997	Long et al.	D30/161
D387,507	S	*	12/1997	Willinger et al.	D30/108
5,964,190	A	*	10/1999	Willinger et al.	119/500

5,976,864	A	*	11/1999	Smit et al.	119/168
D425,674	S	*	5/2000	Dykens	D30/112
D432,593	S	*	10/2000	Naughton	D30/110

* cited by examiner

Primary Examiner—Cathy Anne MacCormac
(74) *Attorney, Agent, or Firm*—Mark C. Jacobs

(57) **CLAIM**

The ornamental design for a barn shaped litter box with removable flat roof, as shown and described.

DESCRIPTION

FIG. 1 is a perspective view of the first embodiment;
 FIG. 2 is a front view thereof;
 FIG. 3 is a left side view thereof, the right side is a mirror image;
 FIG. 4 is a top plan view thereof;
 FIG. 5 is a rear view thereof;
 FIG. 6 is a bottom plan view thereof;
 FIG. 7 is a front elevational view of the roof, the rear elevational view being a mirror image;
 FIG. 8 is a bottom perspective inside view of the roof;
 FIG. 9 is a bottom plan view of the roof;
 FIG. 10 is a top perspective view thereof without the roof;
 FIG. 11 is the top plan view of FIG. 10;
 FIG. 12 is a front and left perspective view of a second embodiment;
 FIG. 13 is a front view of FIG. 12, the rear view is a mirror image.
 FIG. 14 is a left side view of FIG. 12;
 FIG. 15 is a top plan view of FIG. 12;
 FIG. 16 is a right side view of FIG. 12; and,
 FIG. 17 is a bottom plan view of FIG. 12.

1 Claim, 5 Drawing Sheets

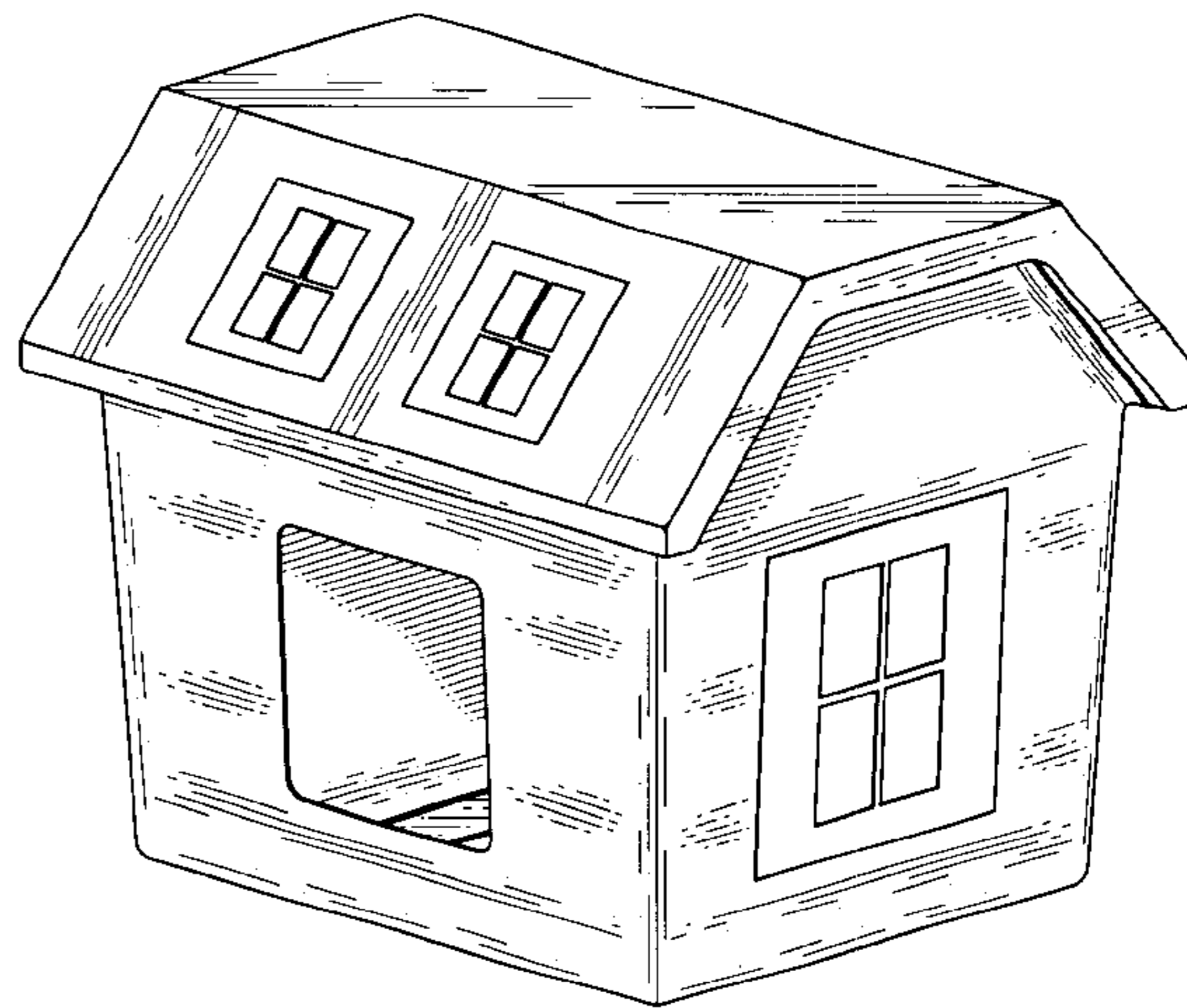
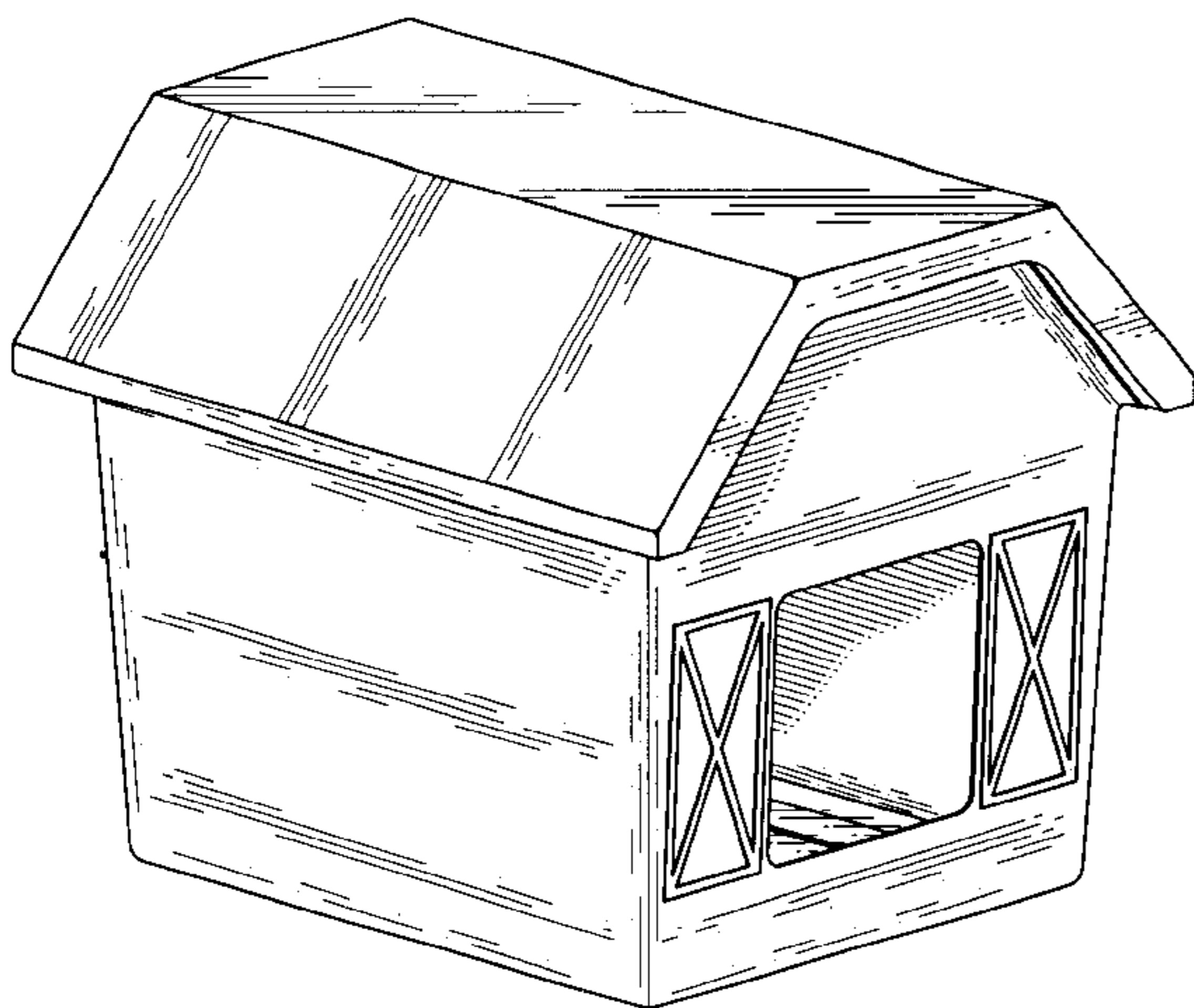

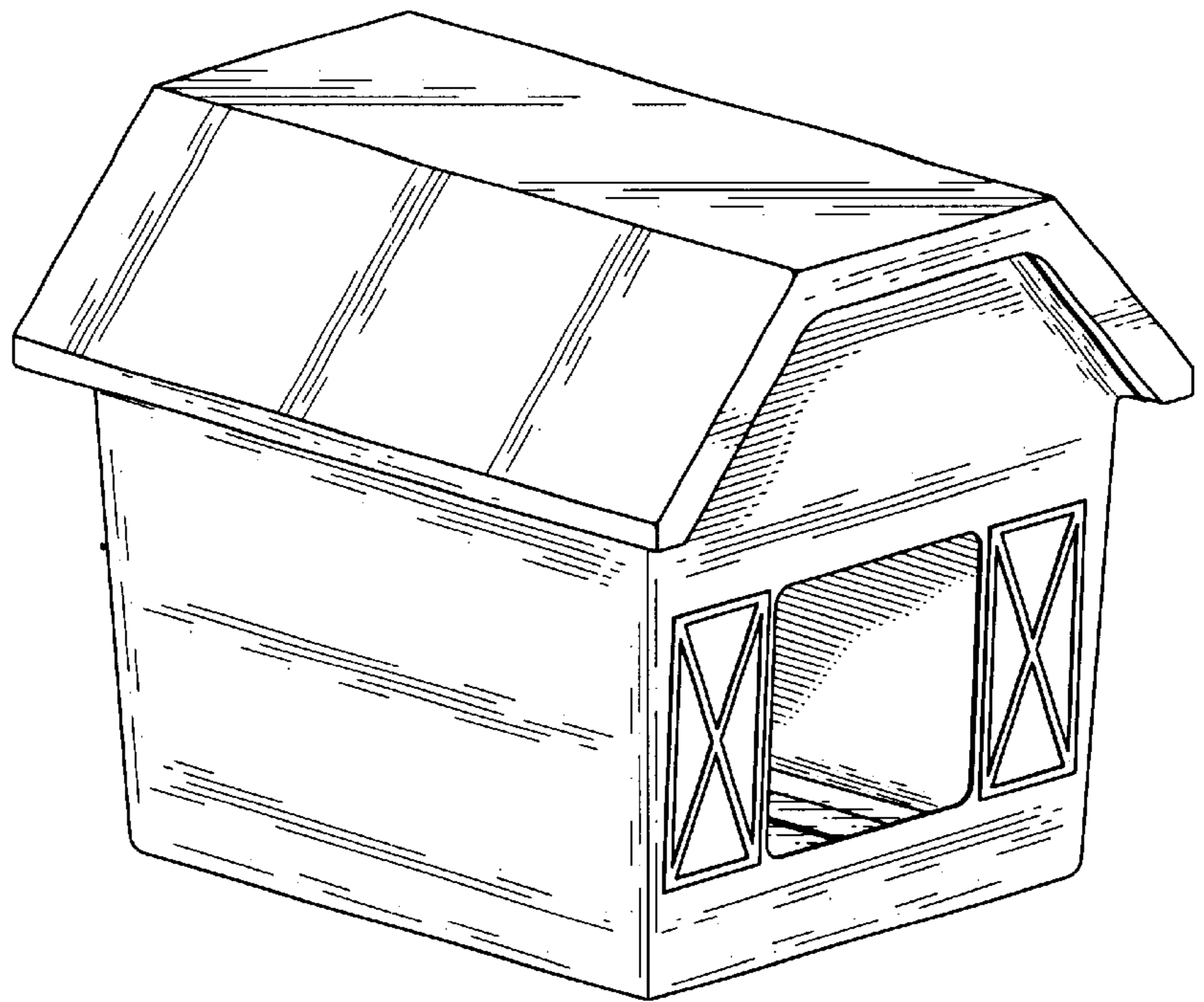

Fig. 1

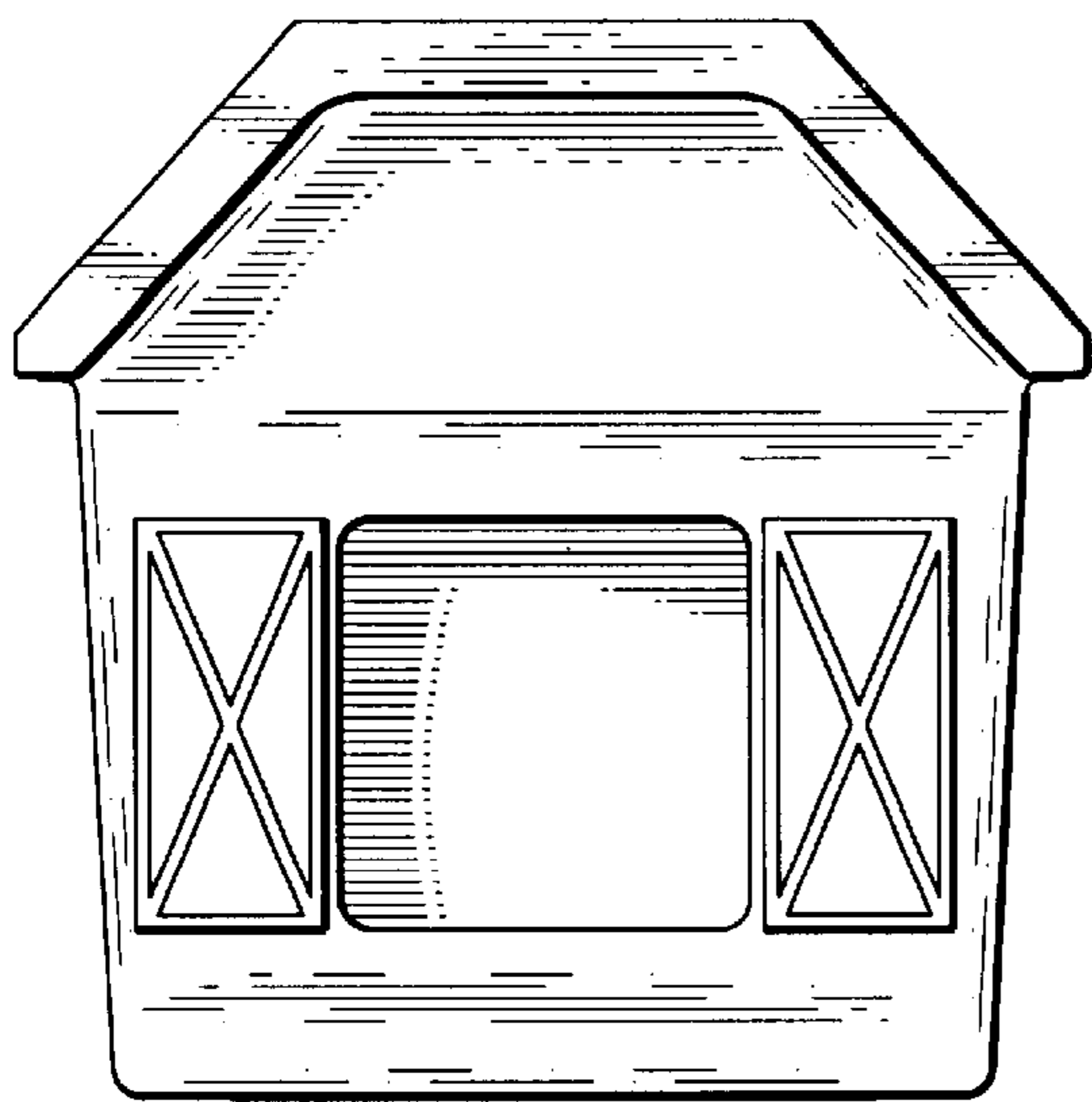

Fig. 2

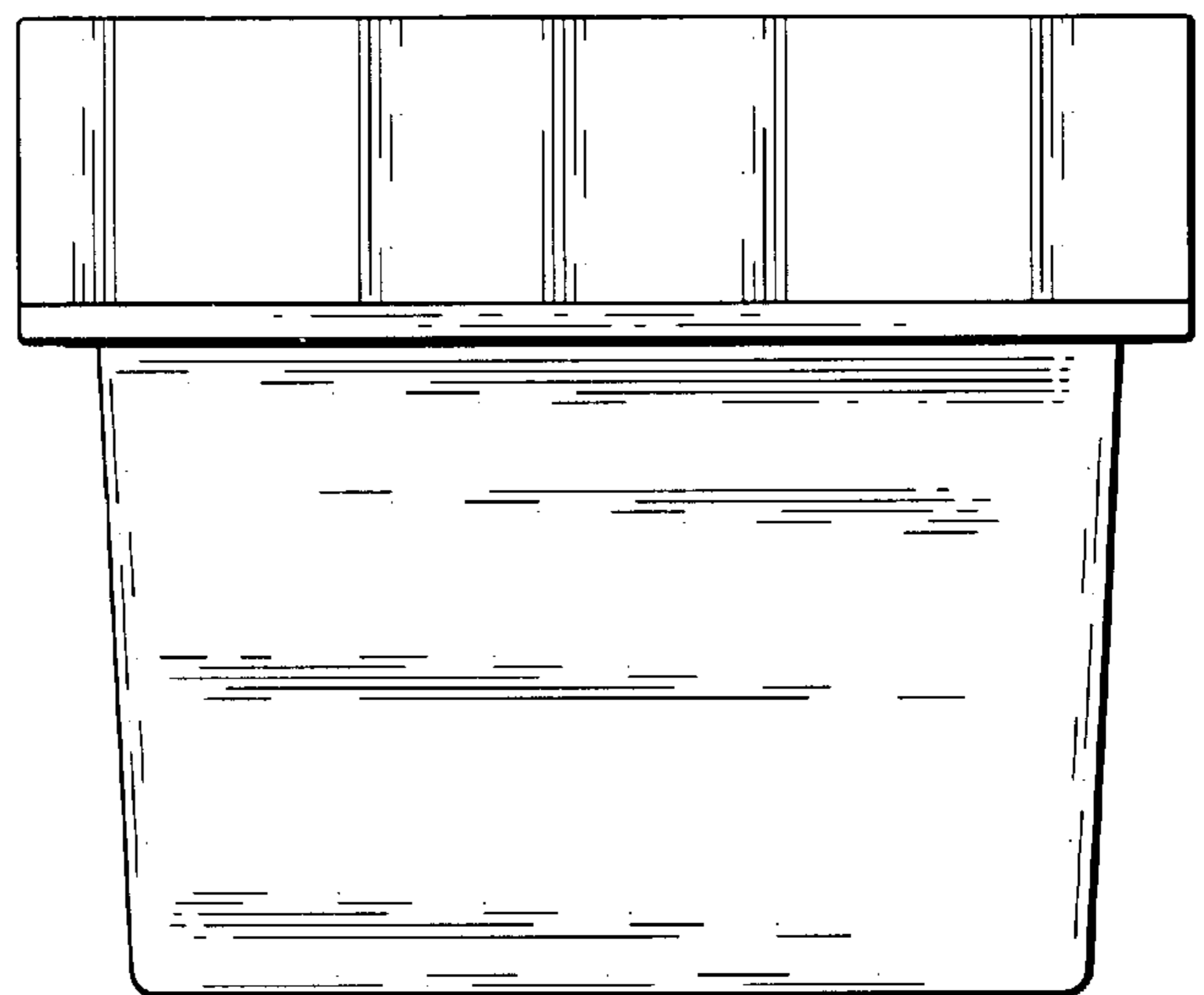

Fig. 3

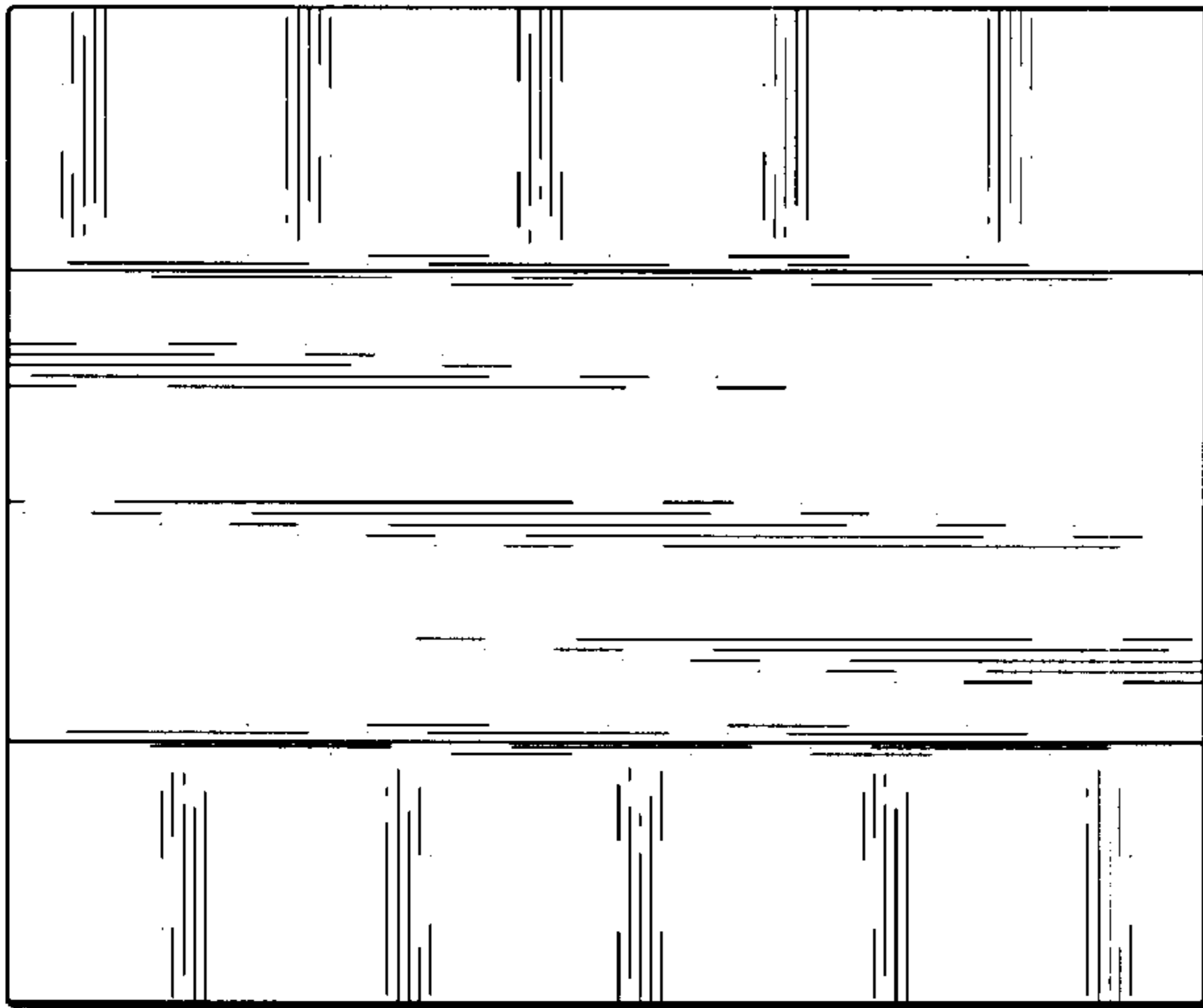

Fig. 4

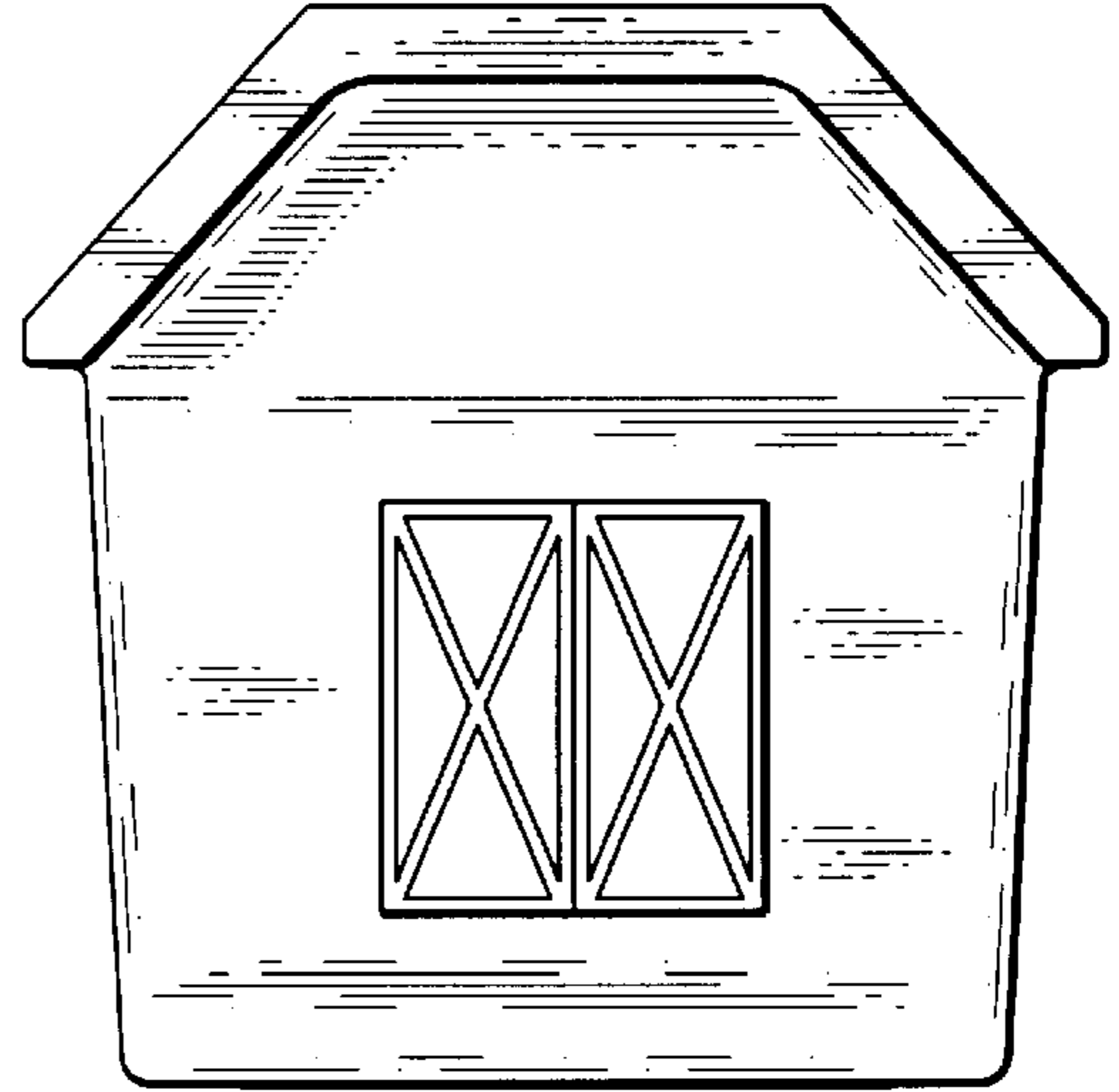

Fig. 5

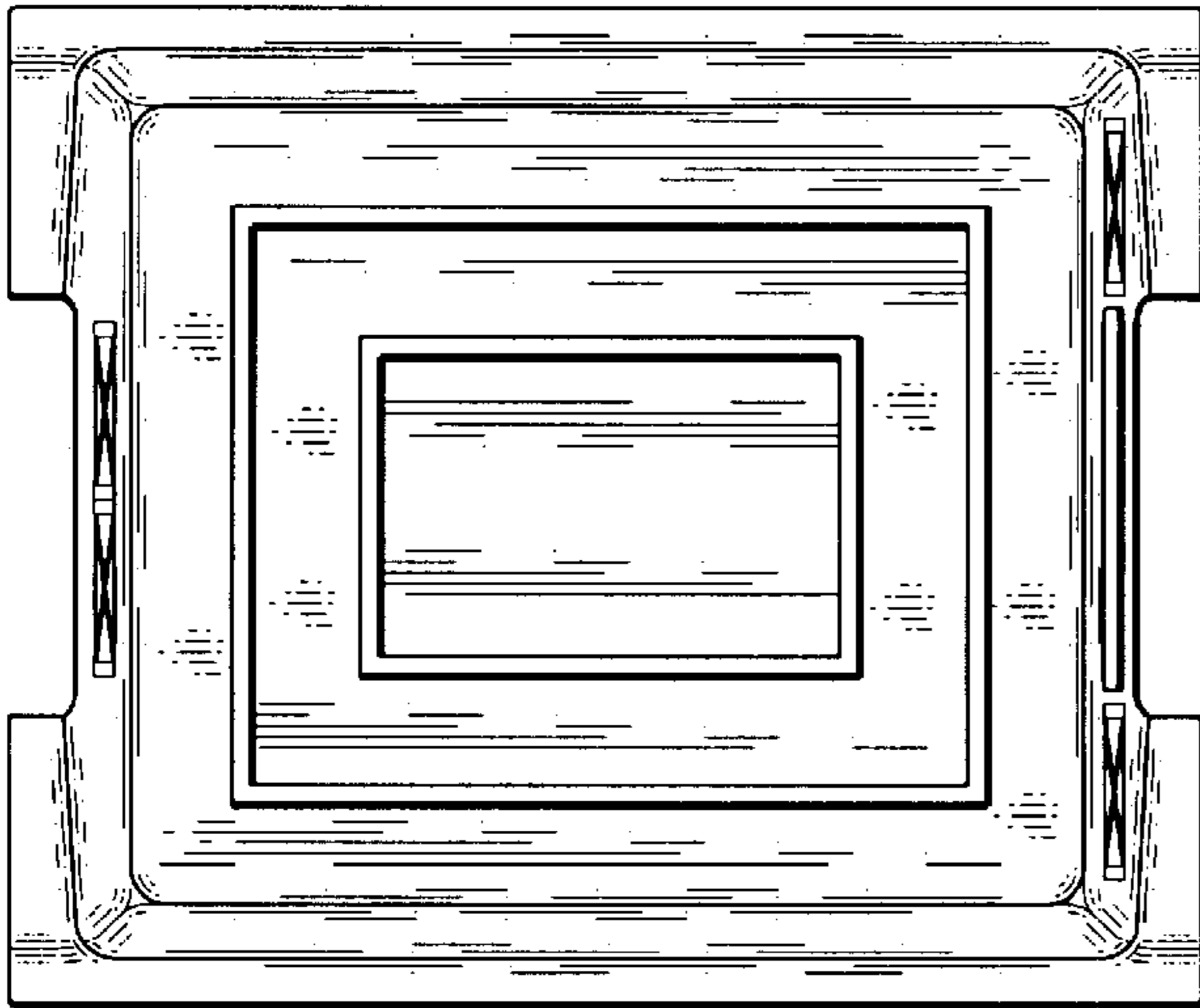

Fig. 6

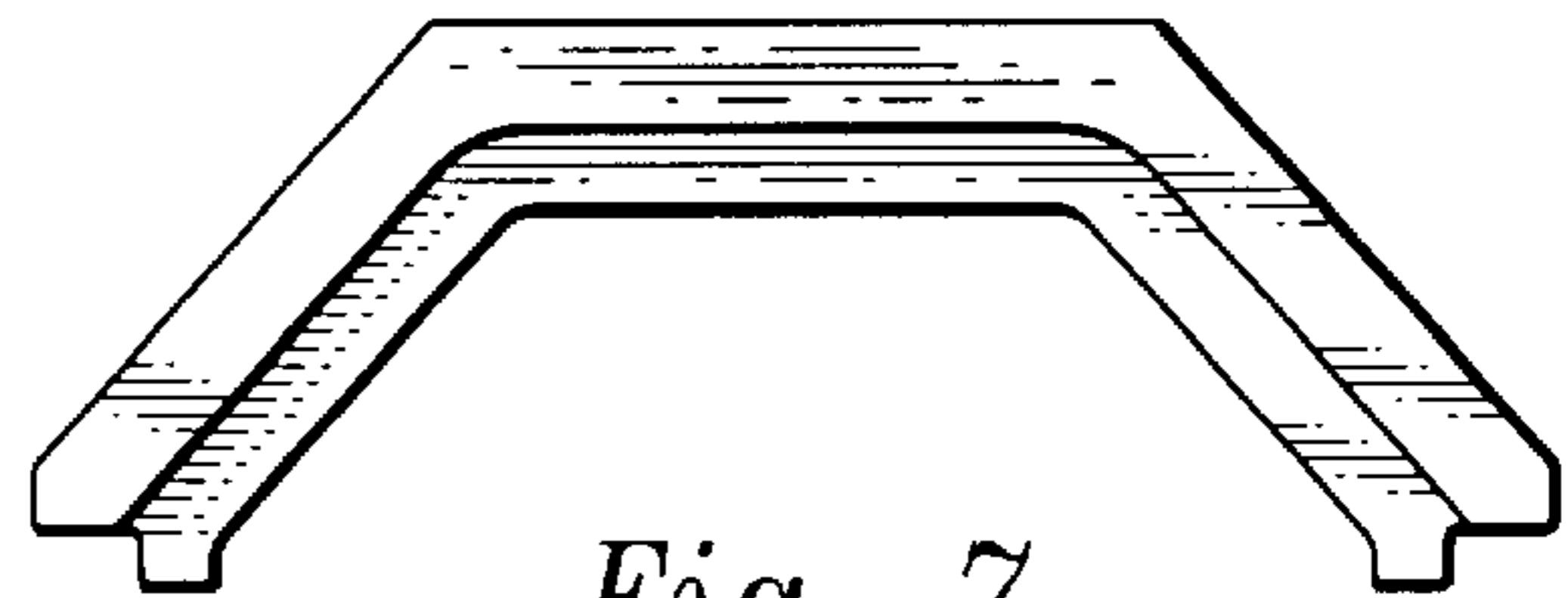

Fig. 7

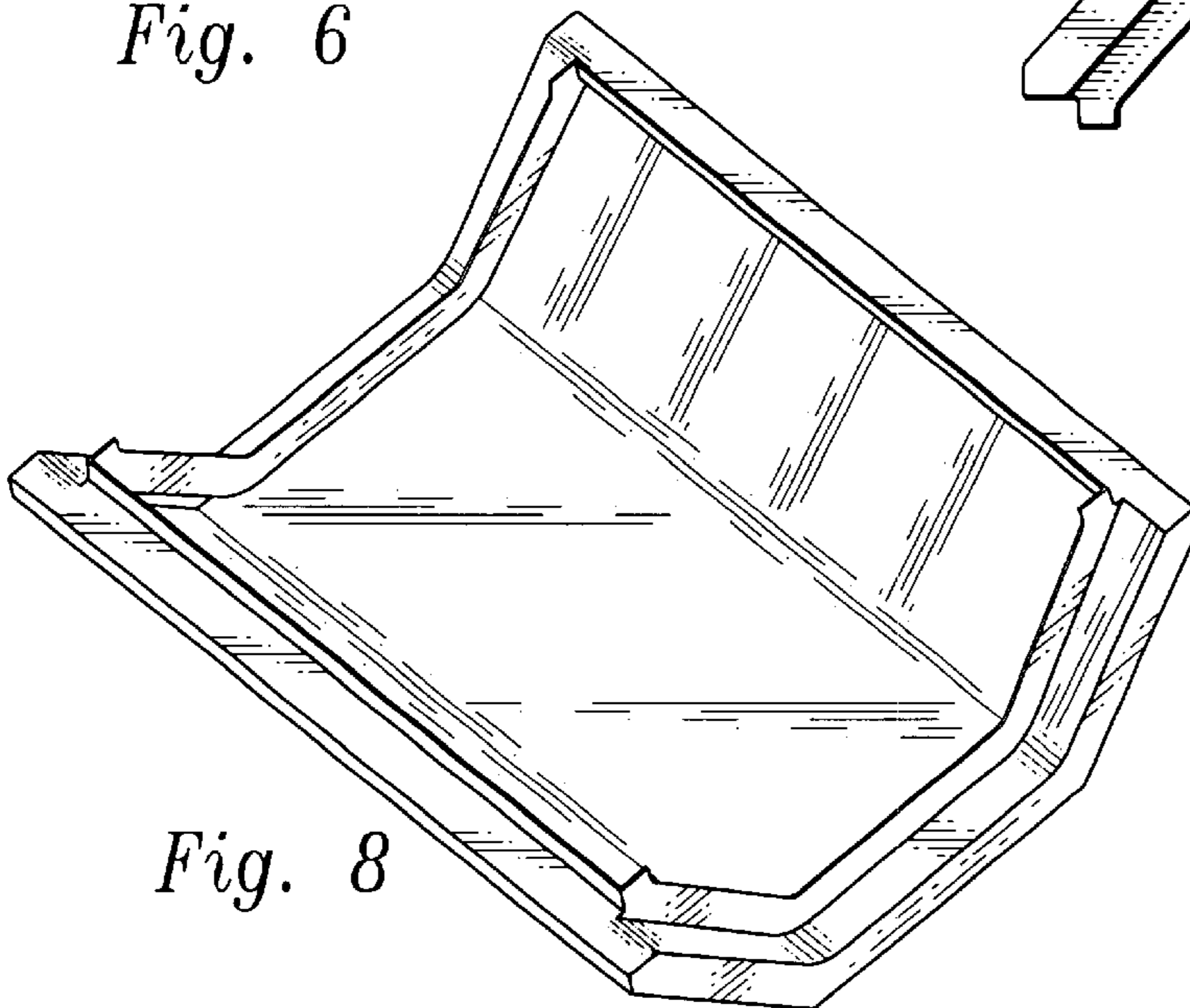

Fig. 8

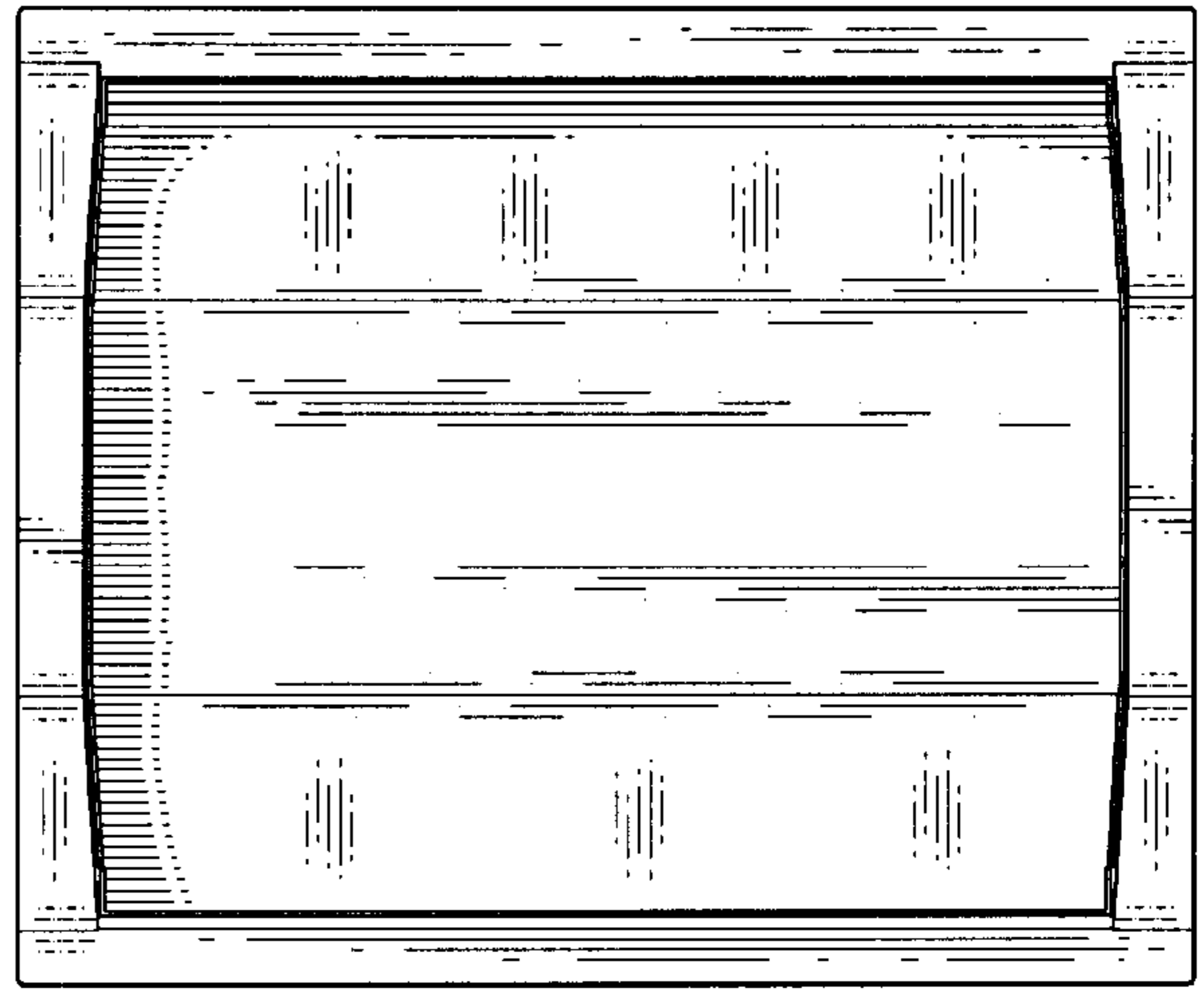

Fig. 9

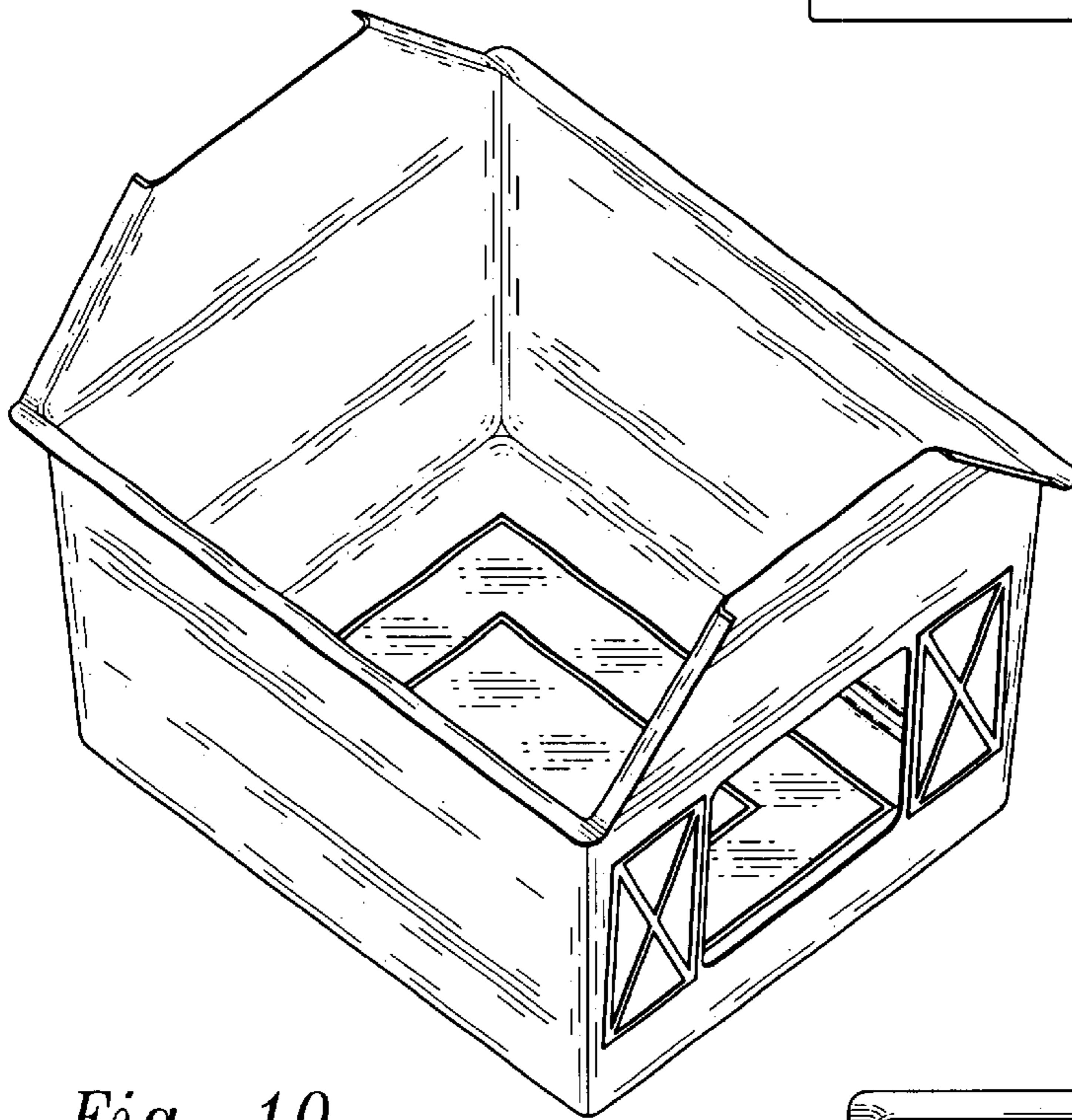

Fig. 10

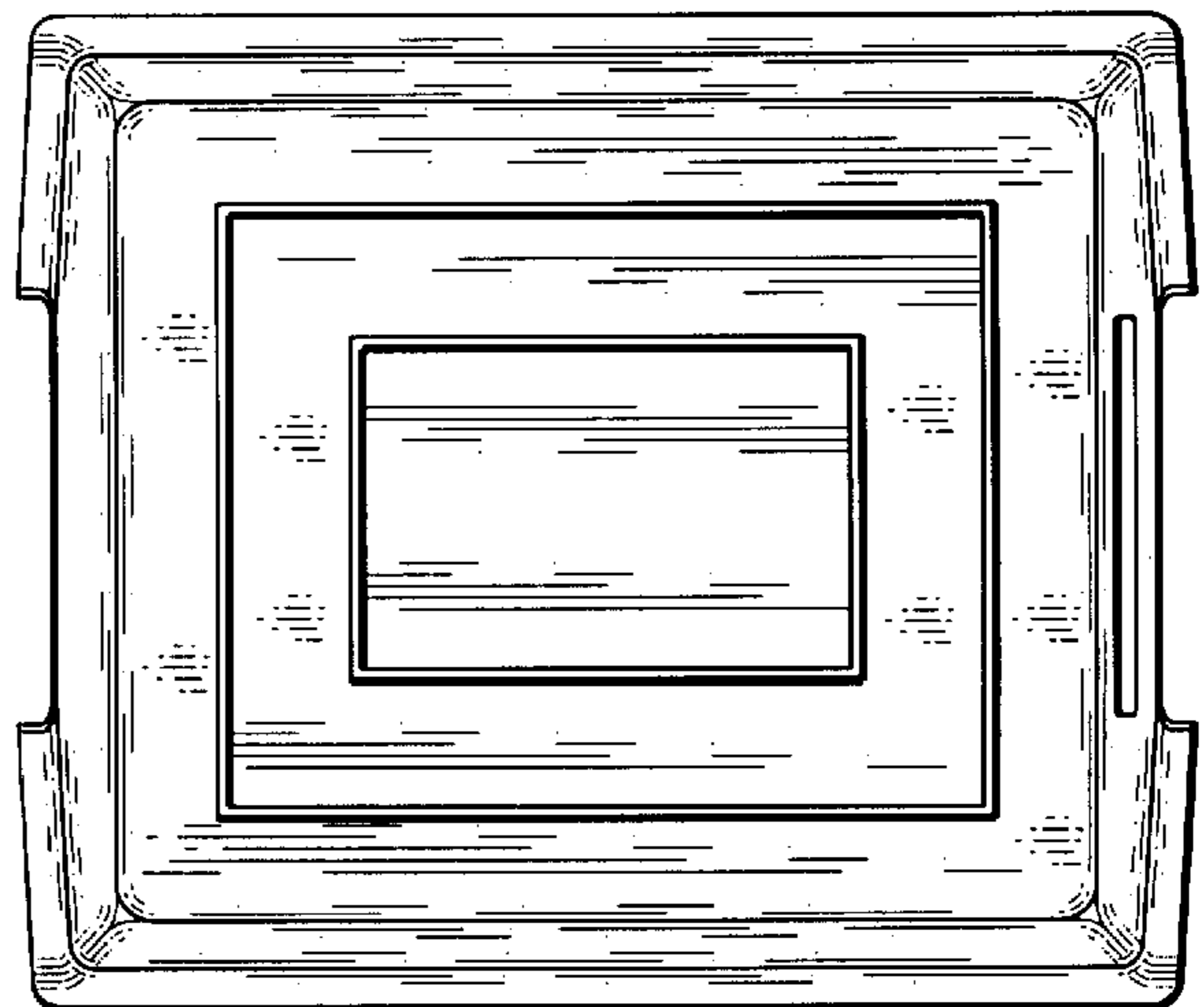

Fig. 11

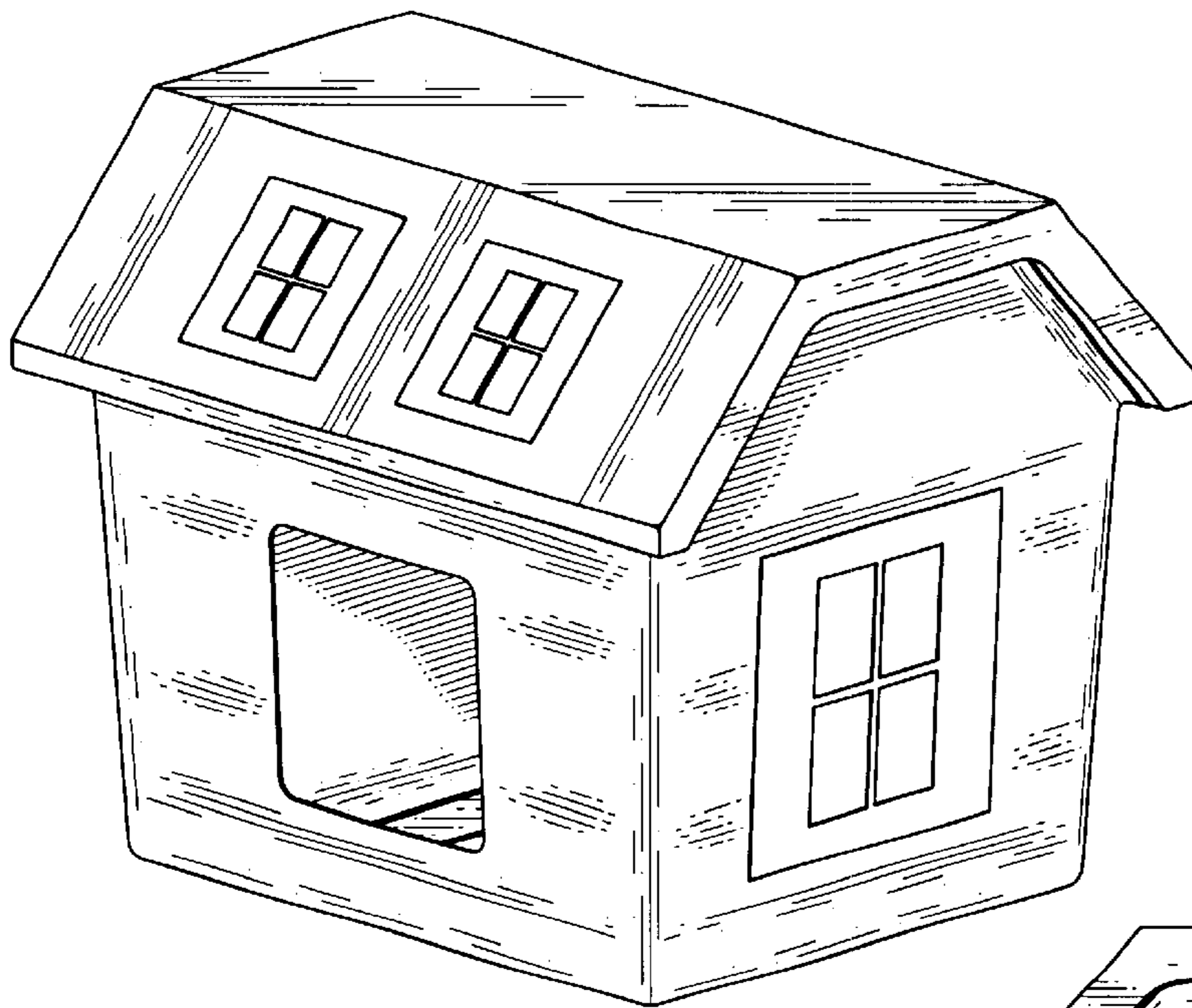

Fig. 12

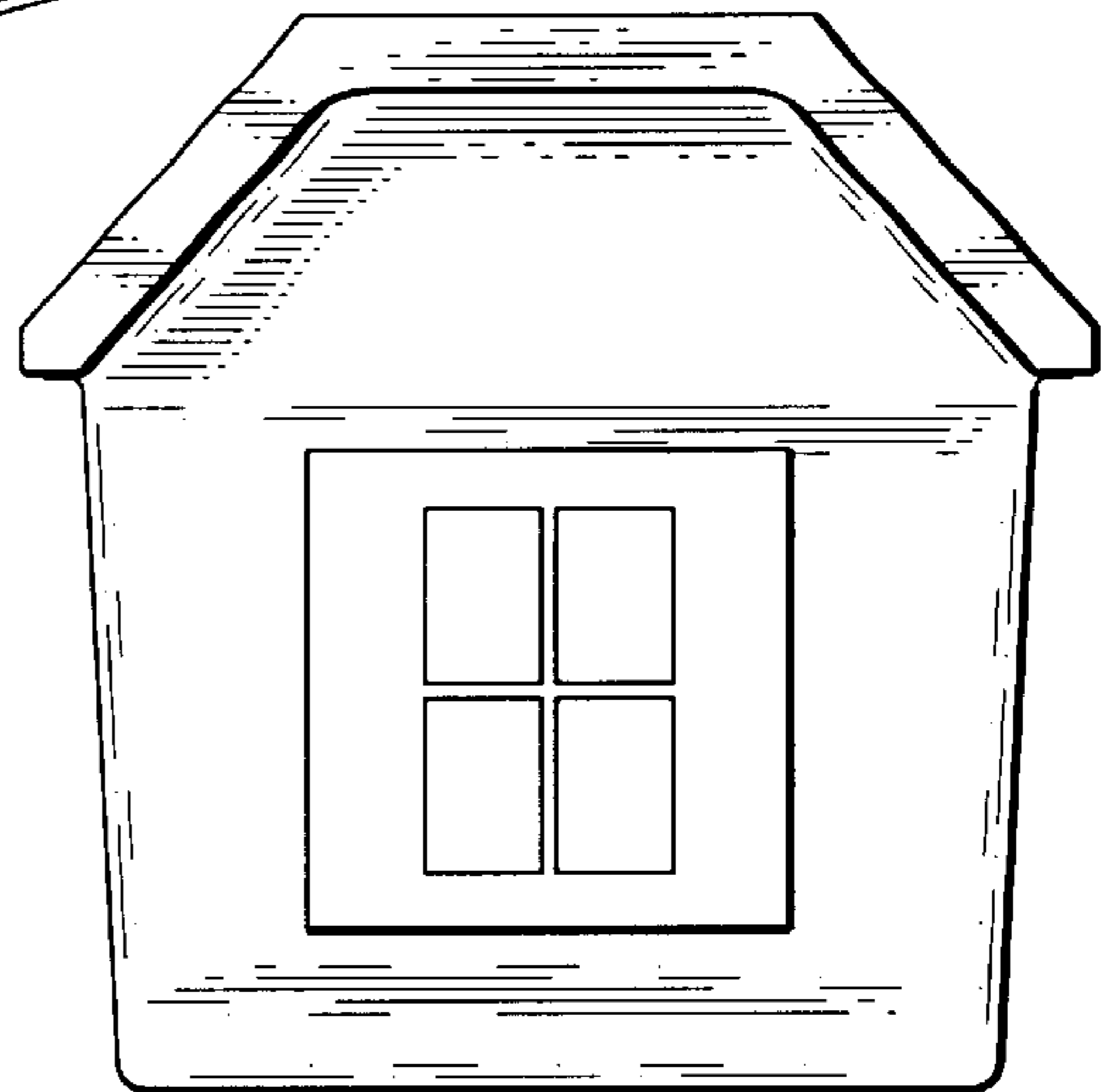

Fig. 13

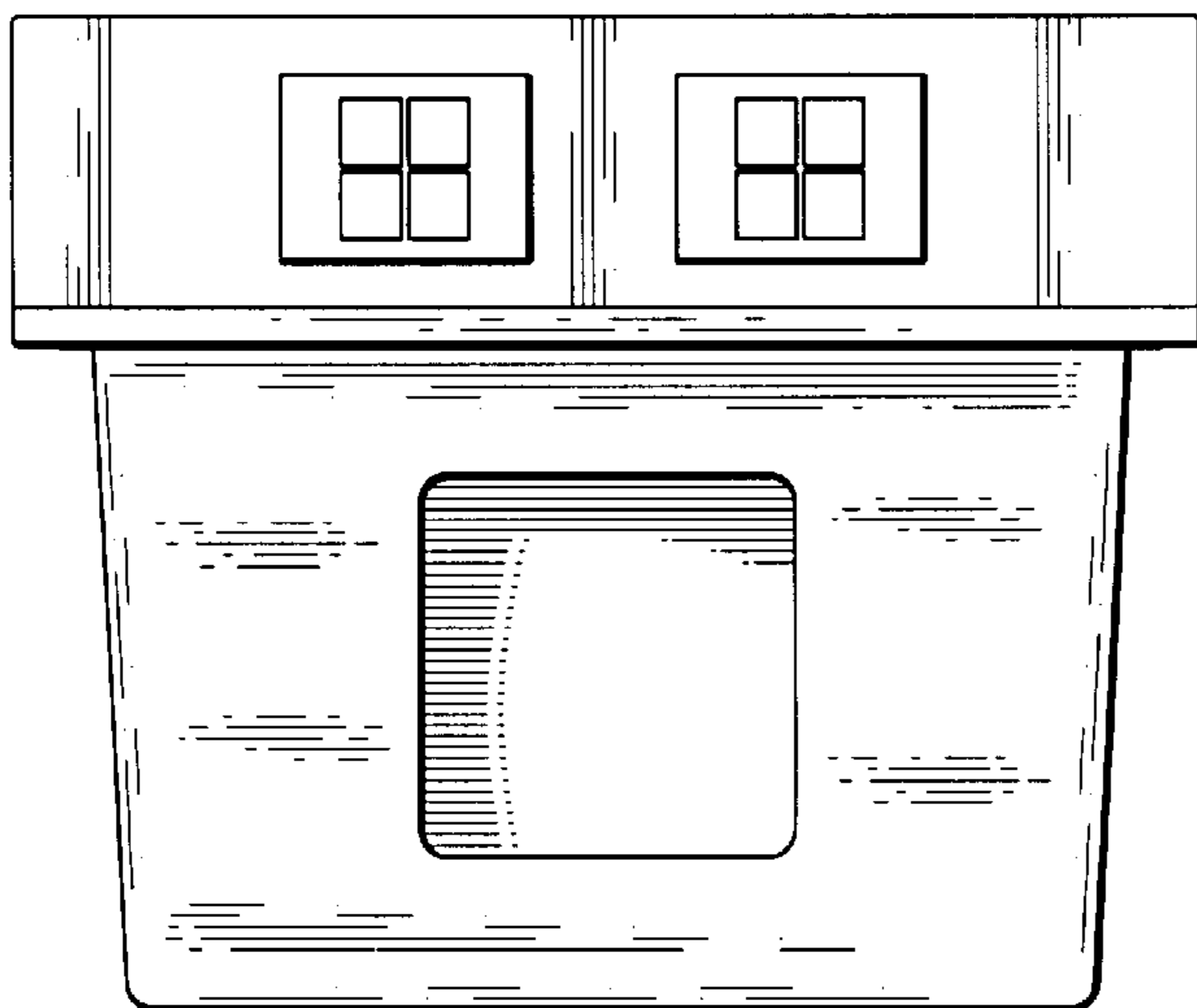

Fig. 14

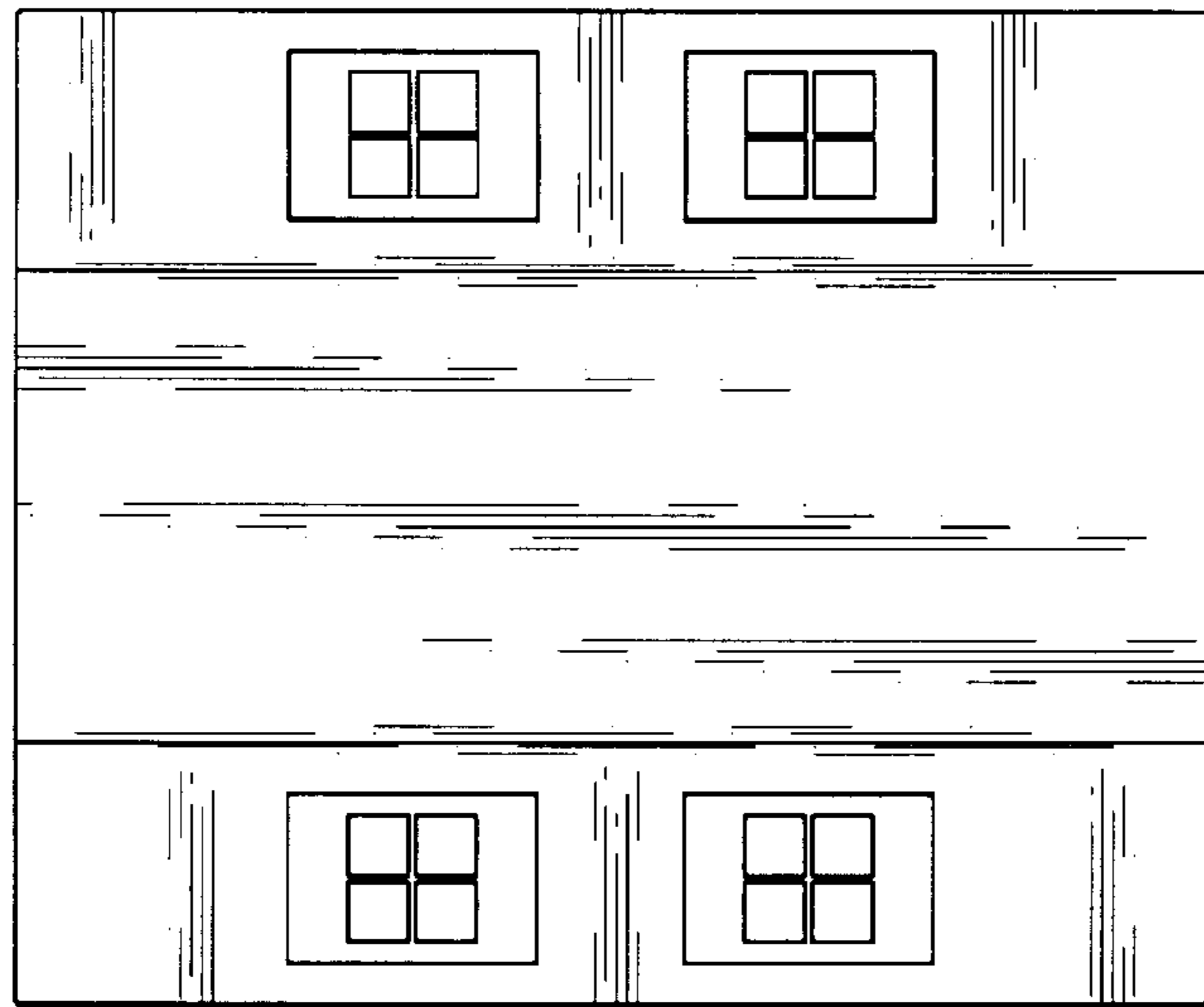

Fig. 15

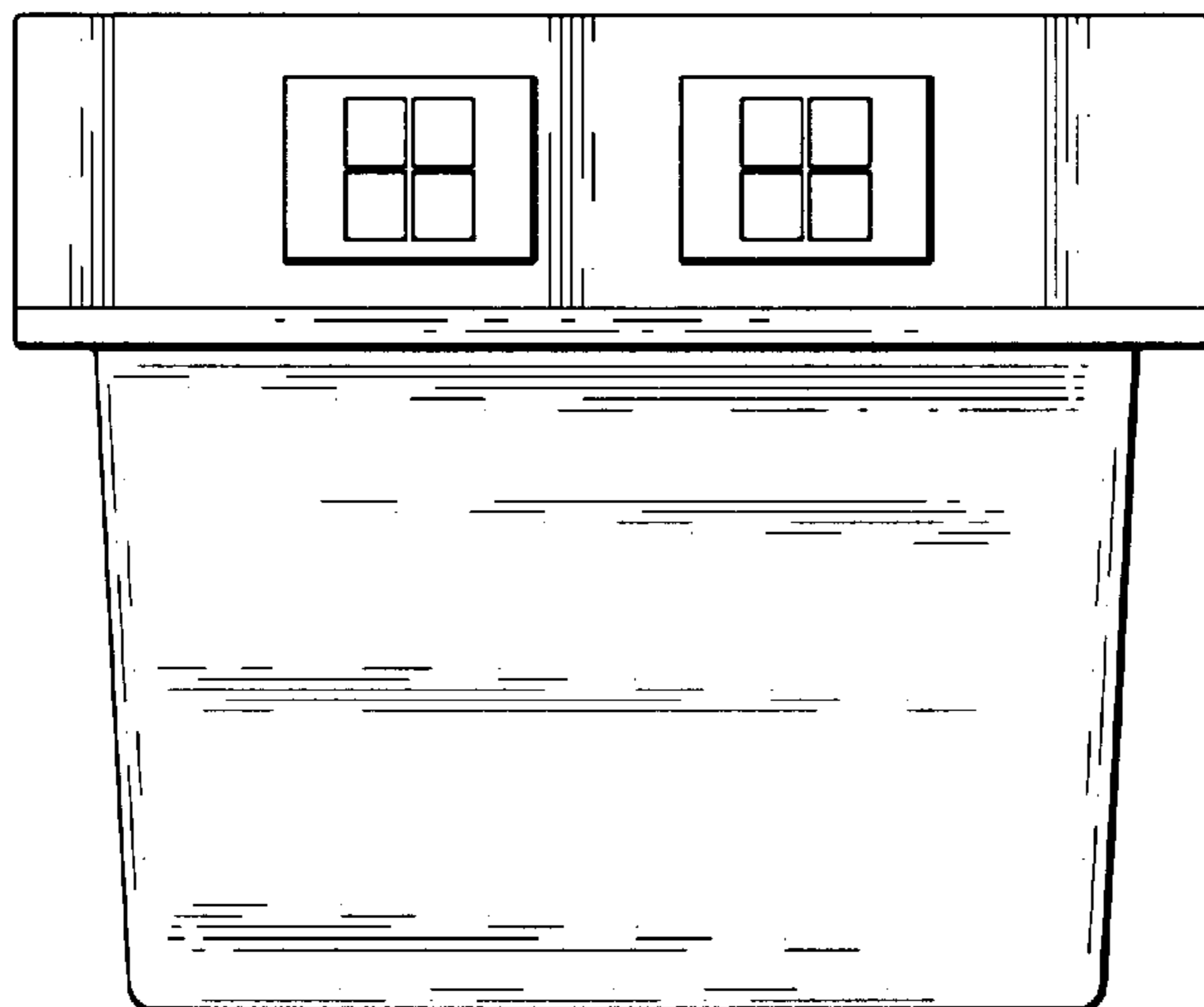

Fig. 16

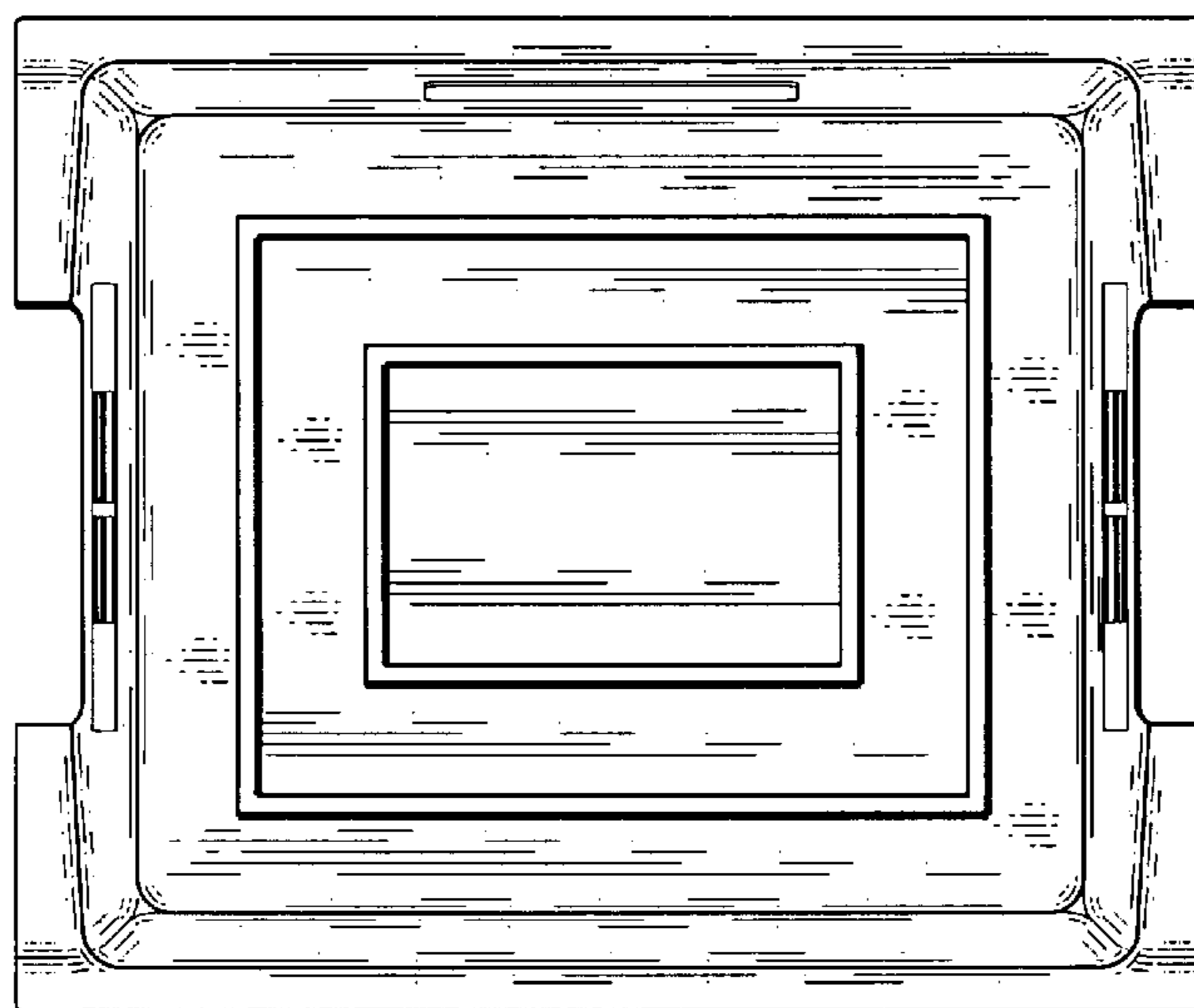

Fig. 17