



US00D473336S

(12) **United States Design Patent**
Huang

(10) **Patent No.:** **US D473,336 S**

(45) **Date of Patent:** **** Apr. 15, 2003**

(54) **SUPPORT FRAME OF A TABLE LAMP**

6,113,250 A * 9/2000 Lin 362/413
D432,695 S * 10/2000 Chen D26/65

(75) Inventor: **Huo-Tu Huang**, Taipei Hsien (TW)

* cited by examiner

(73) Assignee: **Huangslite Industrial Co., Ltd.**, Taipei Hsien (TW)

Primary Examiner—Jennifer Rivard
(74) *Attorney, Agent, or Firm*—Bacon & Thomas, PLLC

(**) Term: **14 Years**

(57) **CLAIM**

(21) Appl. No.: **29/169,044**

The ornamental design for a support frame of a table lamp, as shown and described.

(22) Filed: **Oct. 15, 2002**

(51) **LOC (7) Cl.** **26-99**

(52) **U.S. Cl.** **D26/138**

(58) **Field of Search** D26/61-65, 138,
D26/145, 155; 362/418, 419, 427, 413

DESCRIPTION

(56) **References Cited**

U.S. PATENT DOCUMENTS

5,045,986 A * 9/1991 Lin 362/413
5,339,233 A * 8/1994 Yang 362/413
D388,210 S * 12/1997 Yang D26/65

FIG. 1 is a top, front right side perspective view thereof;
FIG. 2 is a front elevational view thereof;
FIG. 3 is a rear elevational view thereof;
FIG. 4 is a left plan view thereof;
FIG. 5 is a right plan view thereof;
FIG. 6 is a top plan view thereof; and,
FIG. 7 is a bottom plan view thereof.

1 Claim, 6 Drawing Sheets

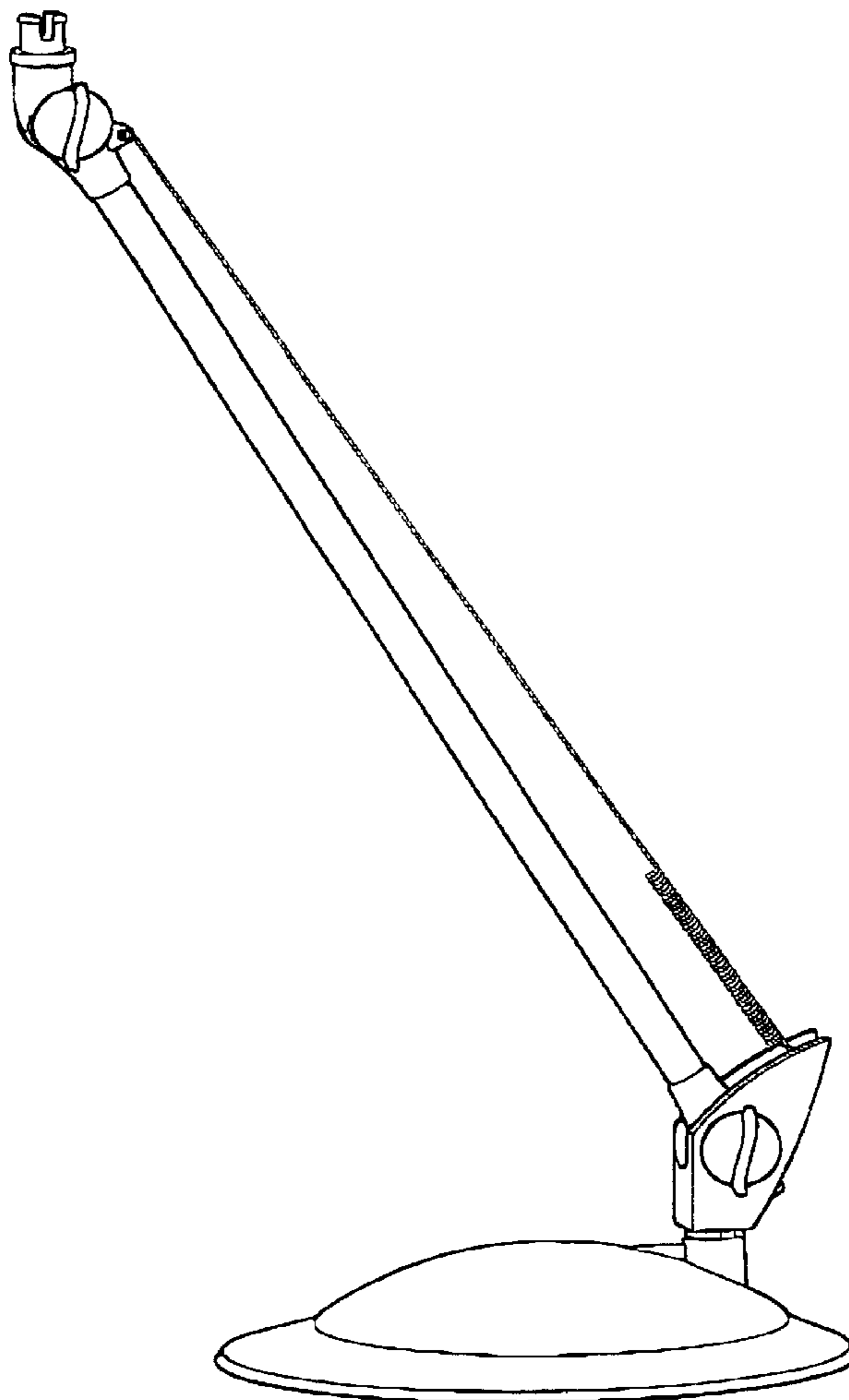

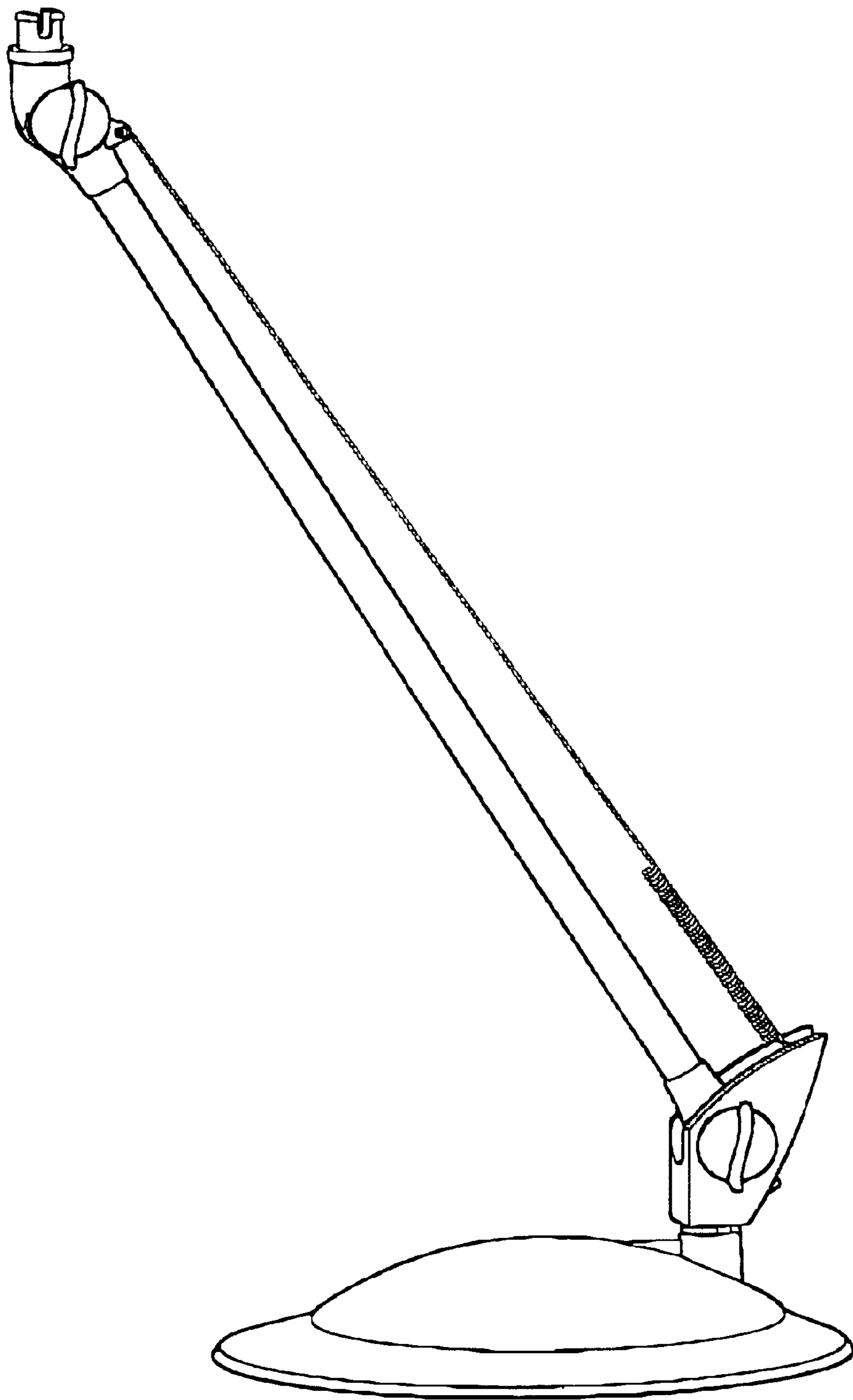

FIG. 1

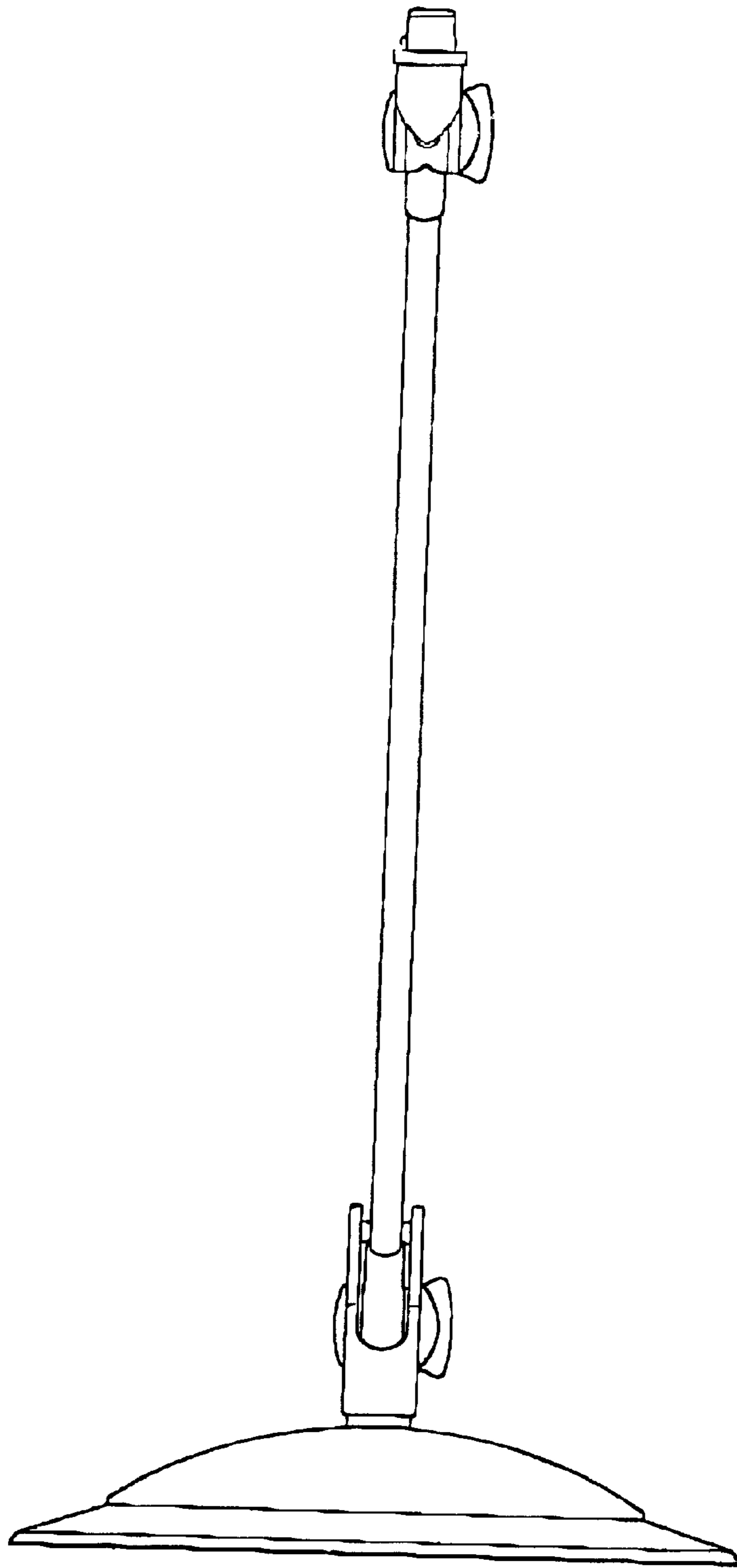

FIG.2

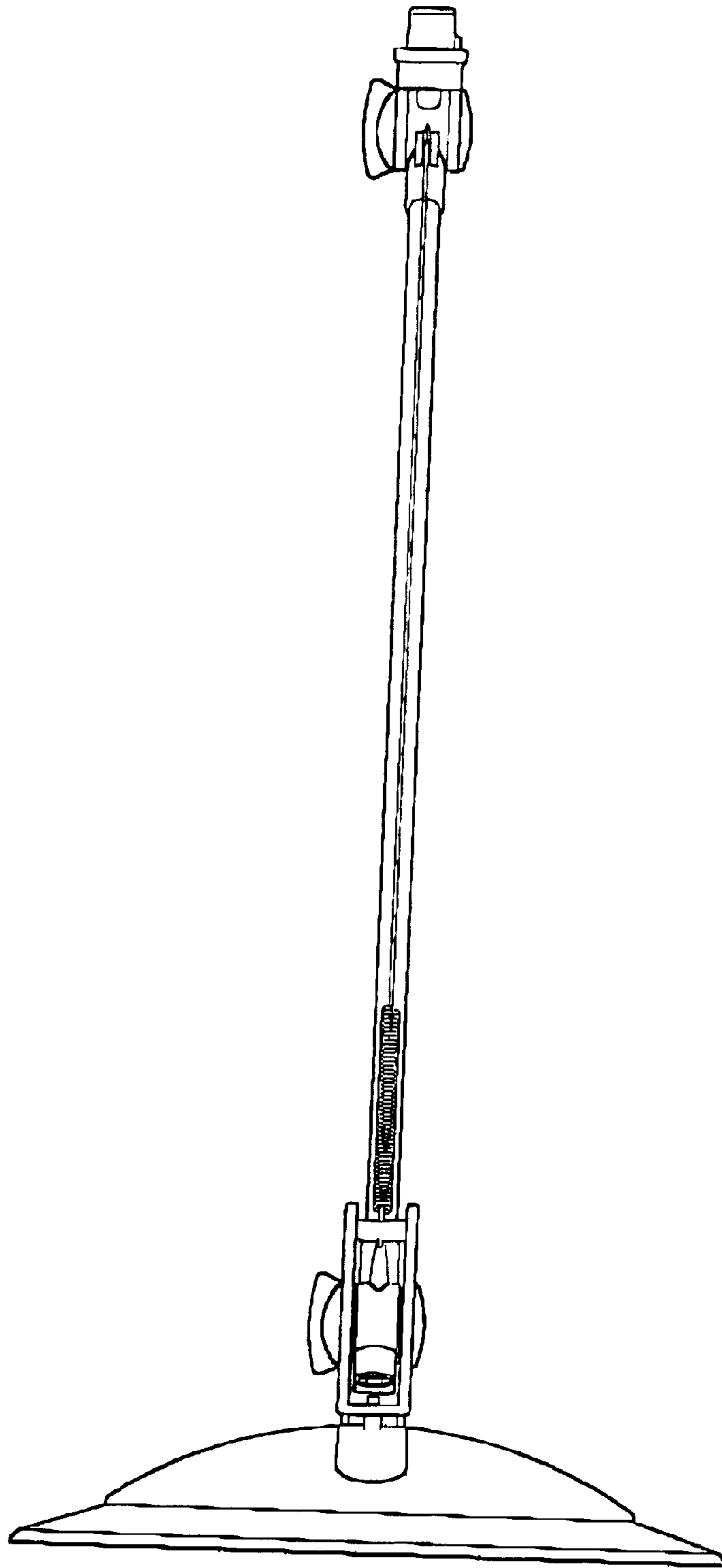

FIG.3

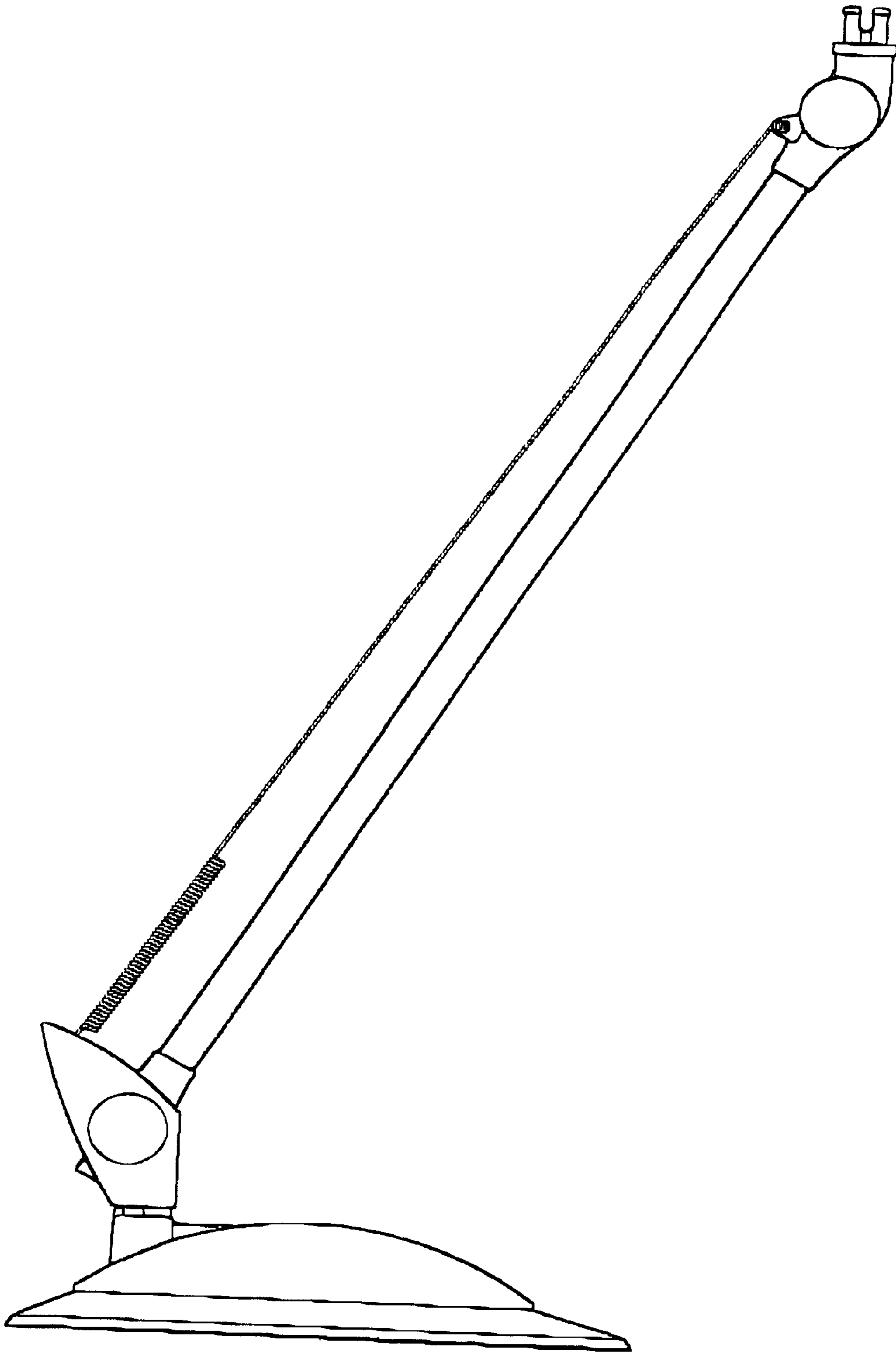

FIG. 4

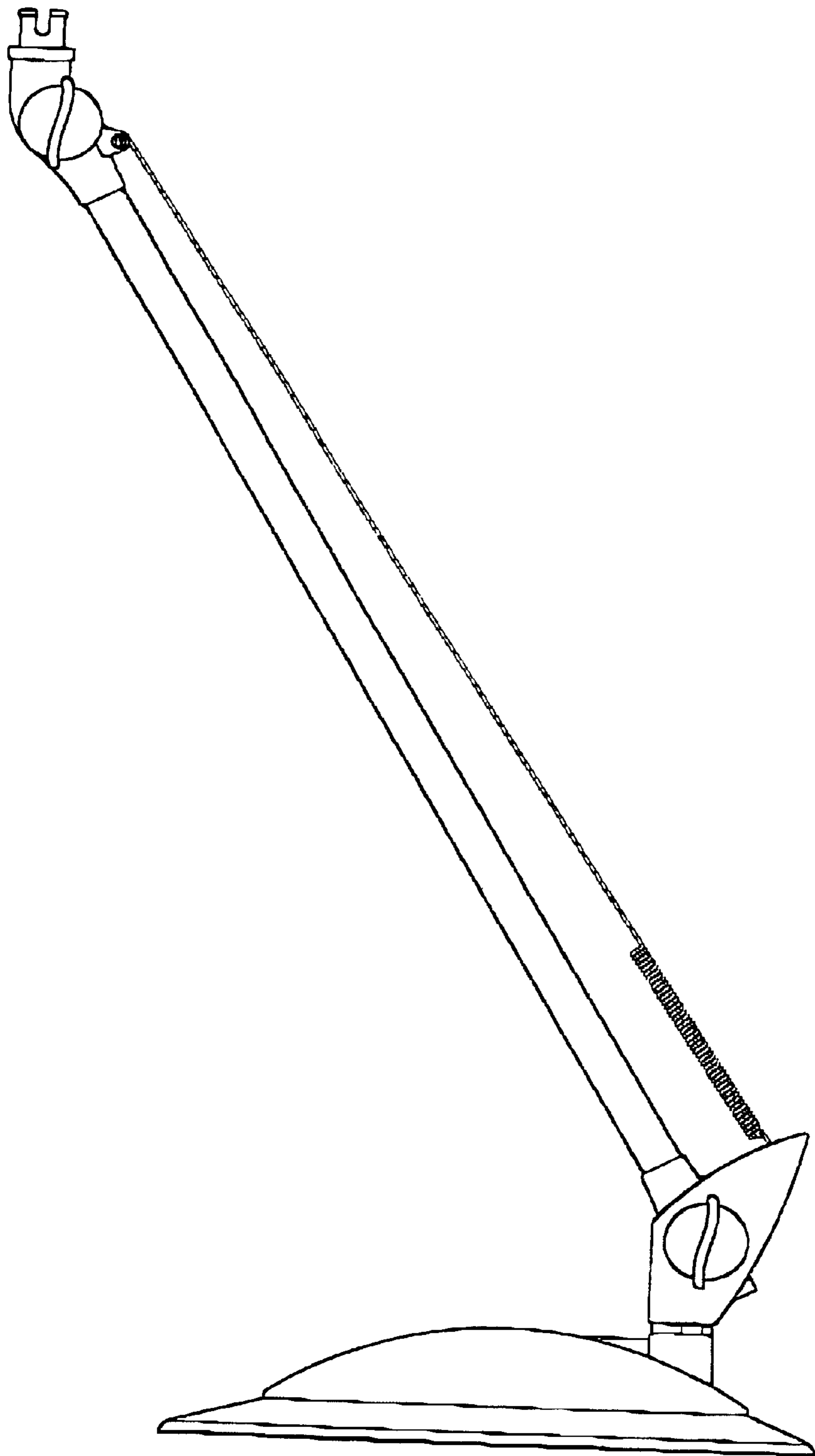

FIG.5

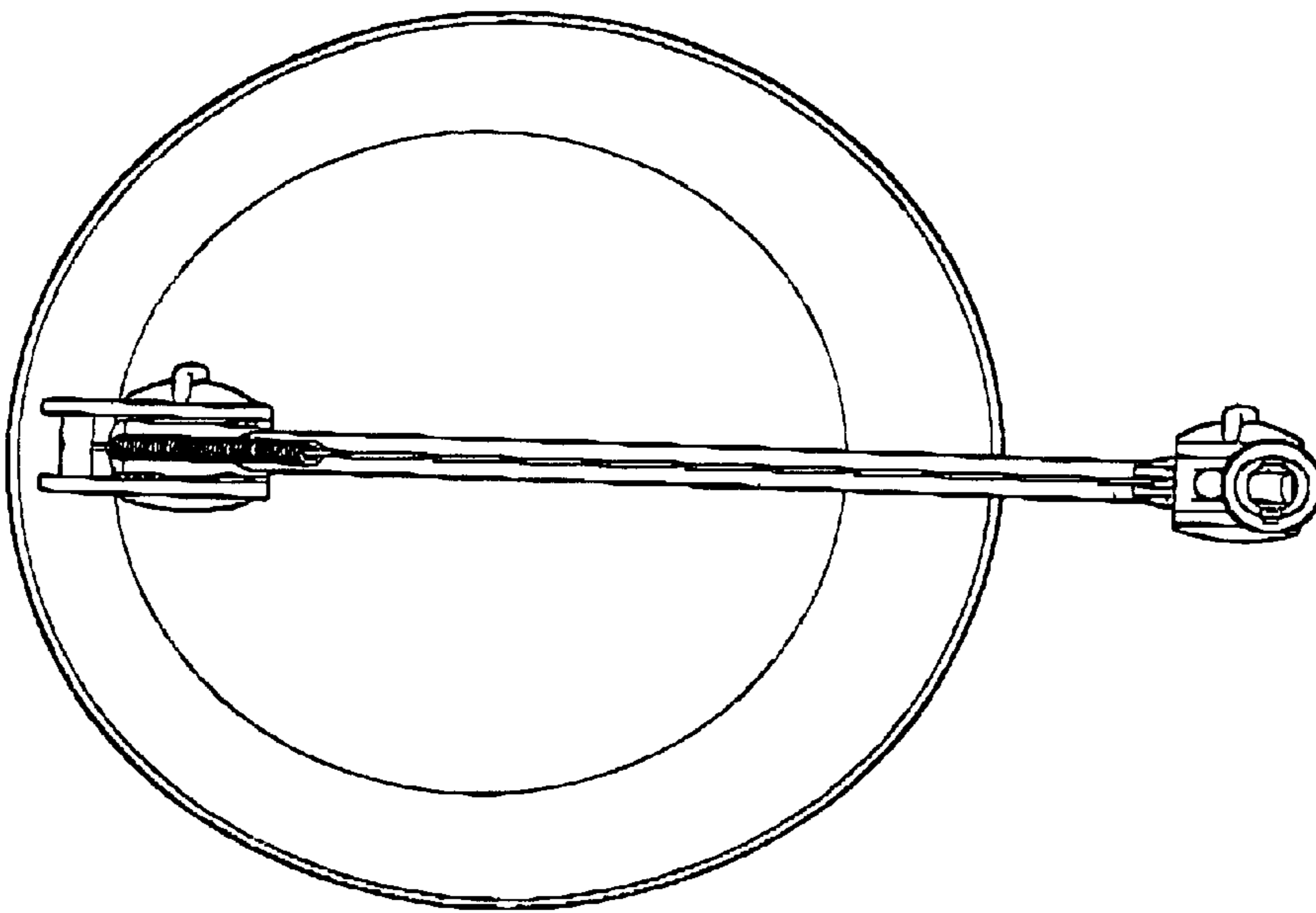

FIG. 6

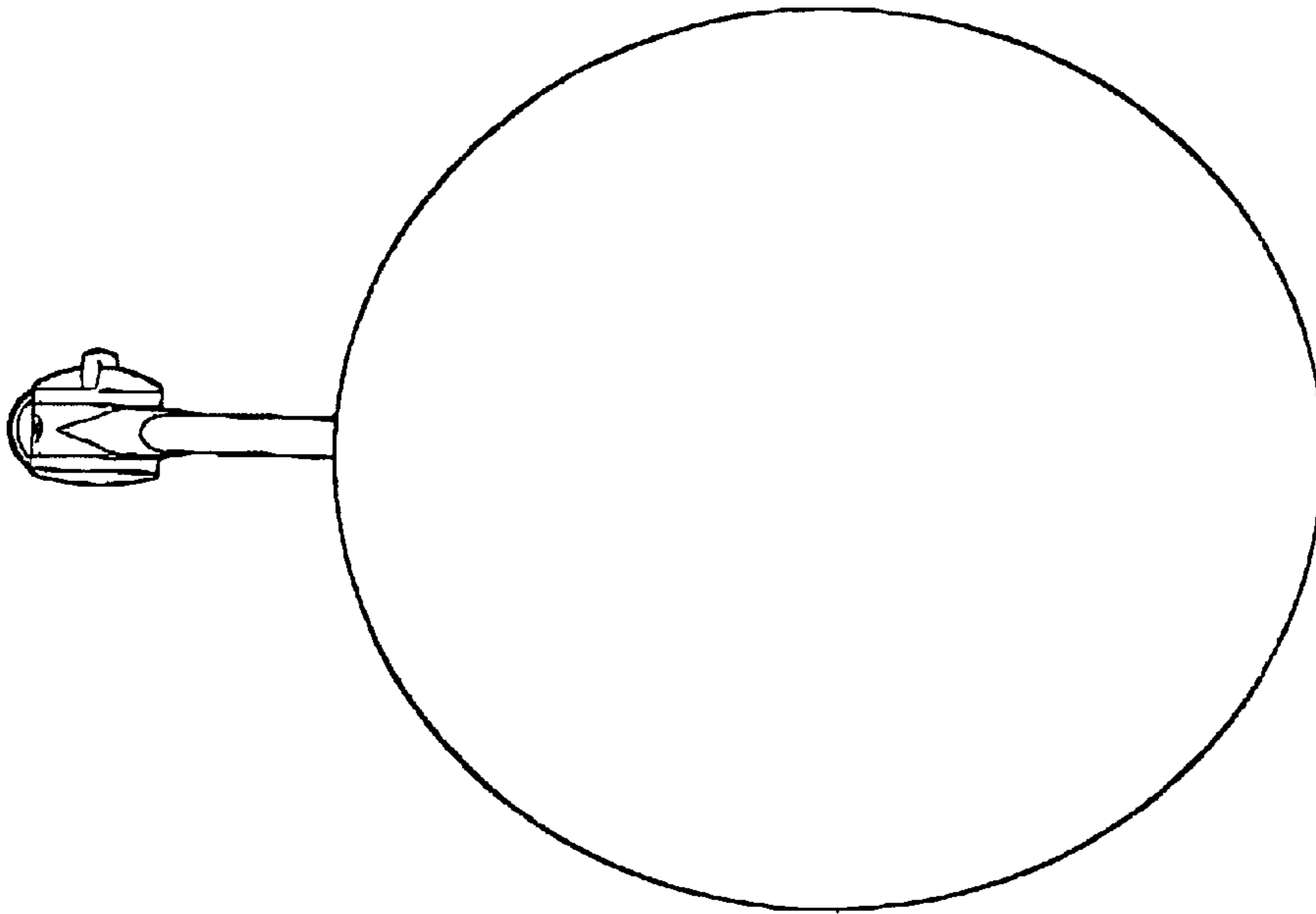

FIG. 7