



US00D473225S

(12) **United States Design Patent**  
**Coglitore**

(10) **Patent No.:** **US D473,225 S**

(45) **Date of Patent:** **\*\* Apr. 15, 2003**

(54) **PORTION OF A BANK OF COMPUTER CHASSIS MOUNTED TO RACK BARS**

(75) **Inventor:** **Giovanni Coglitore**, Los Gatos, CA (US)

(73) **Assignee:** **Rackable Systems, Inc.**, San Jose, CA (US)

(\*\*) **Term:** **14 Years**

(21) **Appl. No.:** **29/137,456**

(22) **Filed:** **Feb. 20, 2001**

(51) **LOC (7) Cl.** ..... **14-02**

(52) **U.S. Cl.** ..... **D14/308**

(58) **Field of Search** ..... D14/300-302, D14/308, 310; D13/162, 184, 199; 312/298, 336, 223.1-223.3; 360/99.01-99.12; 361/680-685, 690-695, 727, 728; 439/377; 340/635

(56) **References Cited**

**U.S. PATENT DOCUMENTS**

- 3,467,892 A \* 9/1969 Sprude et al. .... 361/728
- 4,702,154 A 10/1987 Dodson
- 4,728,160 A 3/1988 Mondor et al.
- 4,901,200 A 2/1990 Mazura
- 5,136,464 A 8/1992 Ohmori
- 5,277,615 A \* 1/1994 Hastings et al. .... 439/377
- 5,398,159 A 3/1995 Andersson et al.
- 5,432,674 A 7/1995 Hardt
- 5,460,441 A 10/1995 Hastings et al.
- D369,590 S \* 5/1996 Amit ..... D14/308
- 5,515,239 A 5/1996 Kamerman et al.
- 5,528,454 A 6/1996 Niklos
- 5,587,877 A 12/1996 Ryan et al.
- 5,602,721 A 2/1997 Slade et al.
- 5,604,662 A \* 2/1997 Anderson et al. .... 361/685
- 5,668,696 A \* 9/1997 Schmitt ..... 361/685
- 5,691,883 A 11/1997 Nelson
- 5,793,610 A \* 8/1998 Schmitt et al. .... 361/695
- 5,813,243 A 9/1998 Johnson et al.
- 5,886,639 A \* 3/1999 Behl et al. .... 340/635
- 5,896,273 A 4/1999 Varghese et al.

- 5,909,357 A 6/1999 Orr
- 5,947,570 A 9/1999 Anderson et al.
- 5,956,227 A 9/1999 Kitaoka
- 6,002,586 A \* 12/1999 Chen et al. .... 361/695
- 6,160,703 A \* 12/2000 Lopez ..... 361/685

**OTHER PUBLICATIONS**

- U.S. patent application Ser. No. 60/161,578, Coglitore et al., filed Oct. 26, 1999.
- U.S. patent application Ser. No. 09/479,824, Coglitore et al., filed Jan. 7, 2000.
- U.S. patent application Ser. No. 60/183,478, Coglitore et al., filed Feb. 18, 2000.
- U.S. patent application Ser. No. 29/118,970, Coglitore et al., filed Feb. 18, 2000.
- U.S. patent application Ser. No. 09/789,602, Coglitore et al., filed Feb. 20, 2001.
- U.S. patent application Ser. No. 60/270,338, Coglitore, filed Feb. 20, 2001.
- U.S. patent application Ser. No. 60/270,343, Coglitore, filed Feb. 20, 2001.

(List continued on next page.)

*Primary Examiner*—Freda Nunn  
(74) *Attorney, Agent, or Firm*—Morrison & Foerster LLP

(57) **CLAIM**

The ornamental design for a portion of bank of computer chassis mounted to rack bars, shown and described.

**DESCRIPTION**

FIG. 1 is a perspective view of my design;  
FIG. 2 is a front view of my design;  
FIG. 3 is a rear view of my design;  
FIG. 4 is a left side view of my design;  
FIG. 5 is a right side view of my design;  
FIG. 6 is a bottom view of my design; and,  
FIG. 7 is a top view of my design.  
The broken lines are shown in the views for illustrative purposes only and form no part of the claimed design.

**1 Claim, 4 Drawing Sheets**

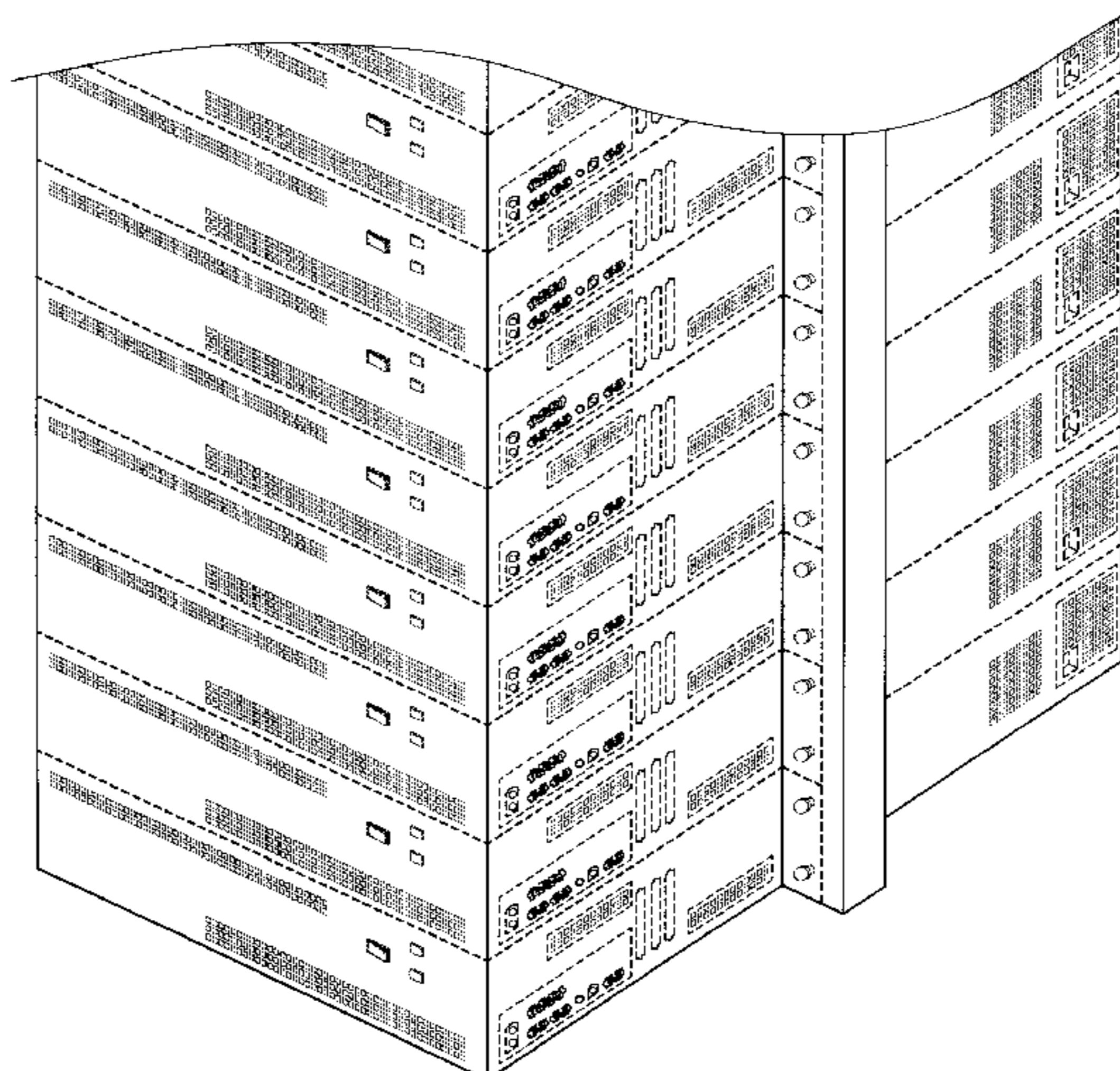

OTHER PUBLICATIONS

U.S. patent application Ser. No. 60/270,403, Coglitore, filed Feb. 20, 2001.

U.S. patent application Ser. No. 60/270,405, Coglitore, filed Feb. 20, 2001.

Anonymous, "Cobalt RaQ 2: Low-Cost, High Density Internet Server Appliance Designed Expressly for ISPs" at <<http://www.cobalt.com/products/pdfs/datasheet.raq2.pdf>> (visited on Nov. 27, 2000), 2 pages.

Anonymous, "Cobalt RaQ 3: Maximum Profitability in the Smallest Rack Space" at <<http://www.cobalt.com/products/pdfs/datasheet.raq3.pdf>> (visited on Nov. 27, 2000), 2 pages.

Anonymous, "Cobalt RaQ 4: Server Appliance Superb Developer Tool Support for More Hosted Applications," at <<http://www.cobalt.com/products/pdfs/datasheet.raq4.pdf>> (visited on Nov. 27, 2000), 2 pages.

Anonymous, "SGI—O2 Workstation Product Overview," at <<http://www.sgi.com/o2/overview.html>> (visited on Sep. 8, 2000), 10 pages.

Anonymous. (Mar. 10, 1988). "Silicon Graphics Unveils Dedicated, Entry-Level Hosting Solution," at <[http://www.sgi.com/newsroom/Press\\_Releases/1998/march/o2webserver\\_release.html](http://www.sgi.com/newsroom/Press_Releases/1998/march/o2webserver_release.html)> (visited on Jan. 6, 2000), 2 pages.

\* cited by examiner

Figure 1

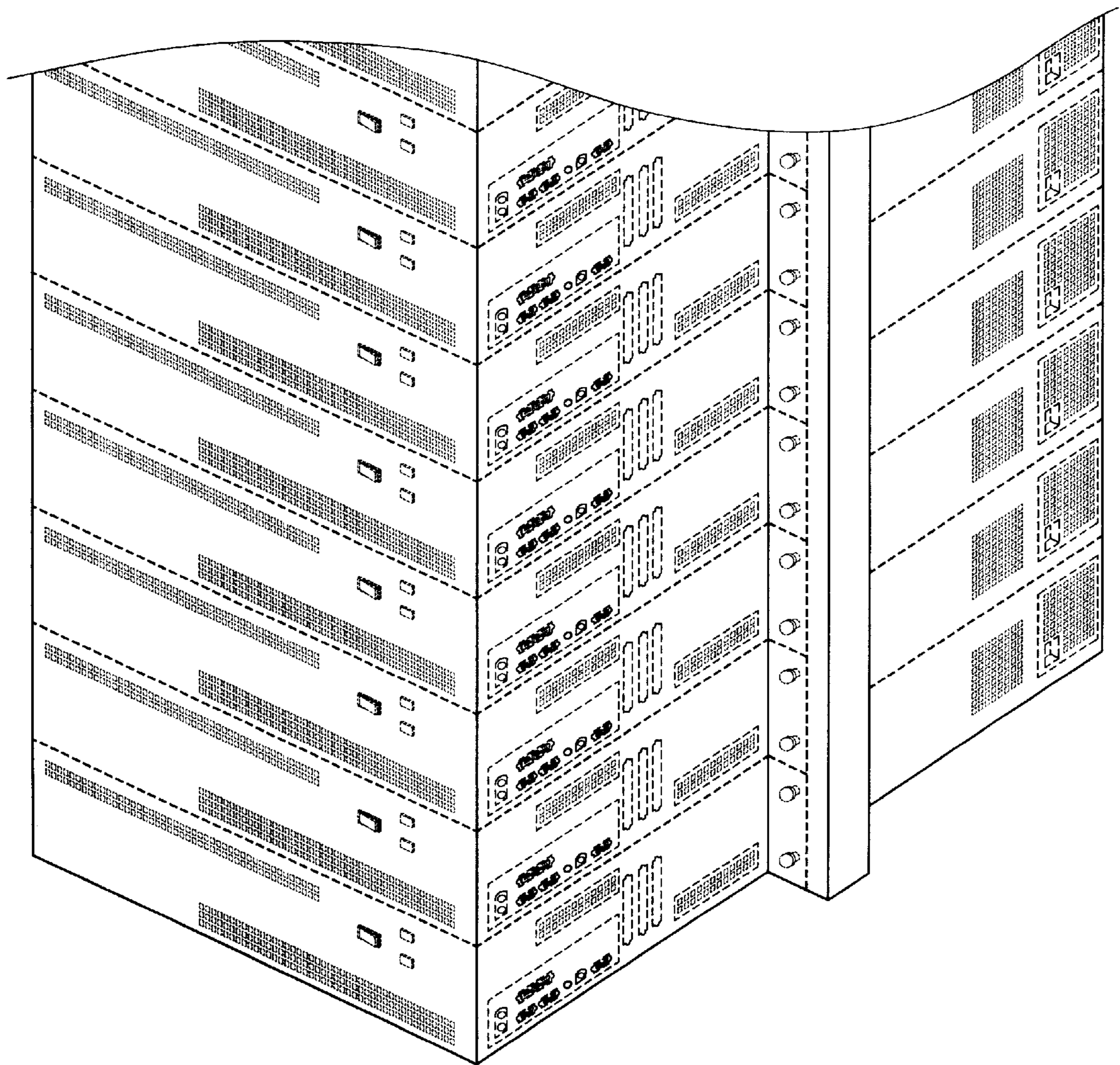

Figure 2

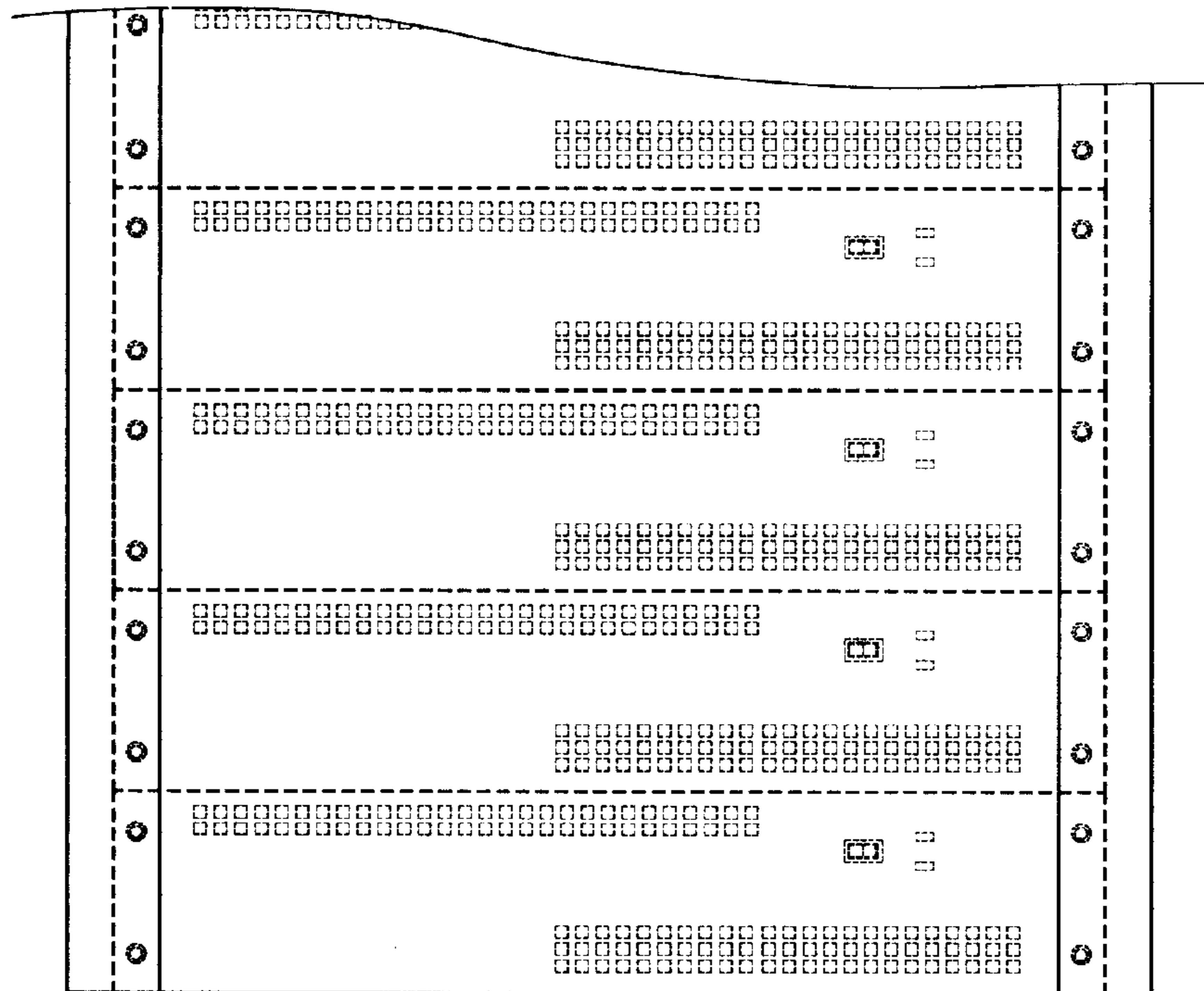

Figure 3

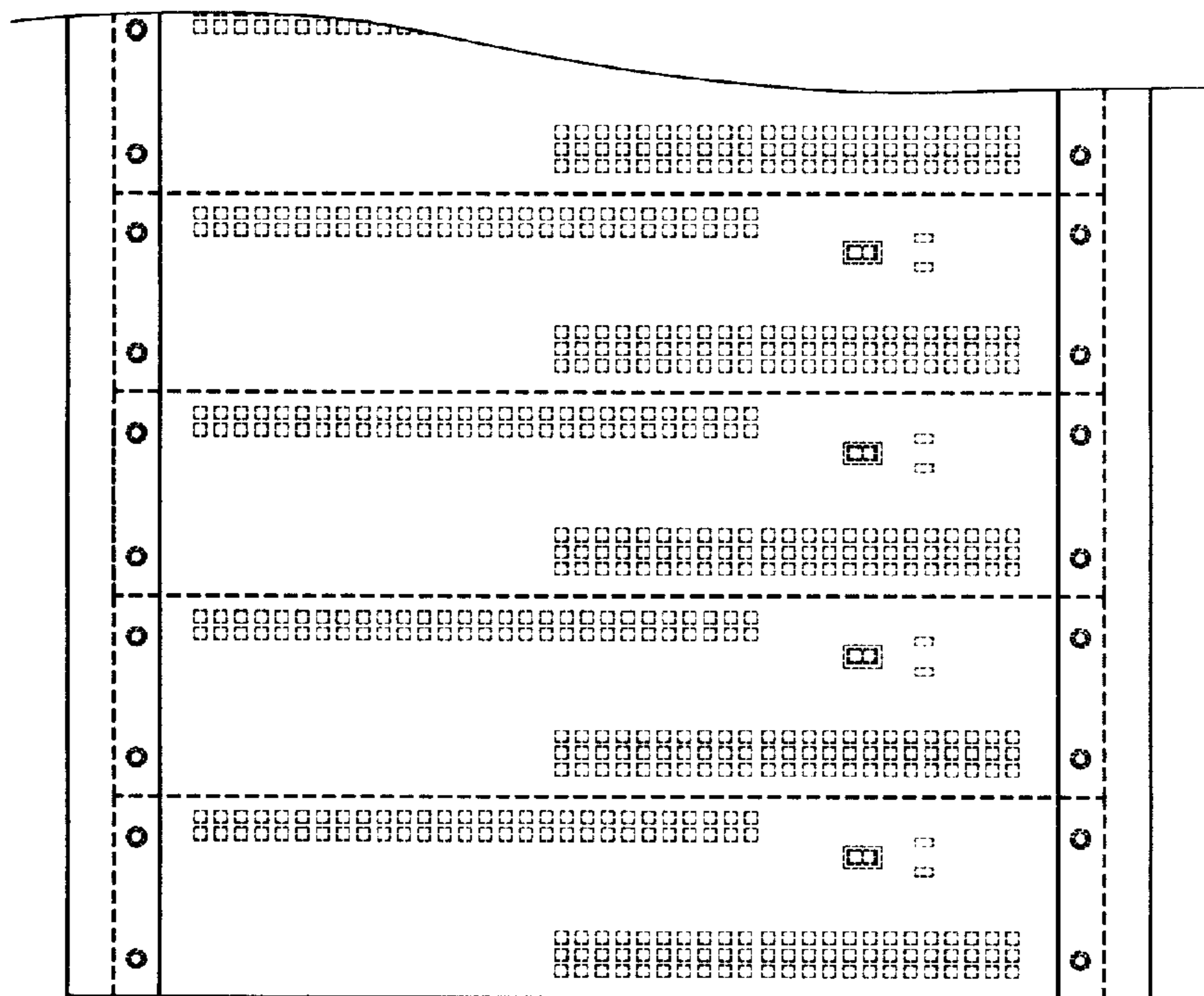

Figure 4

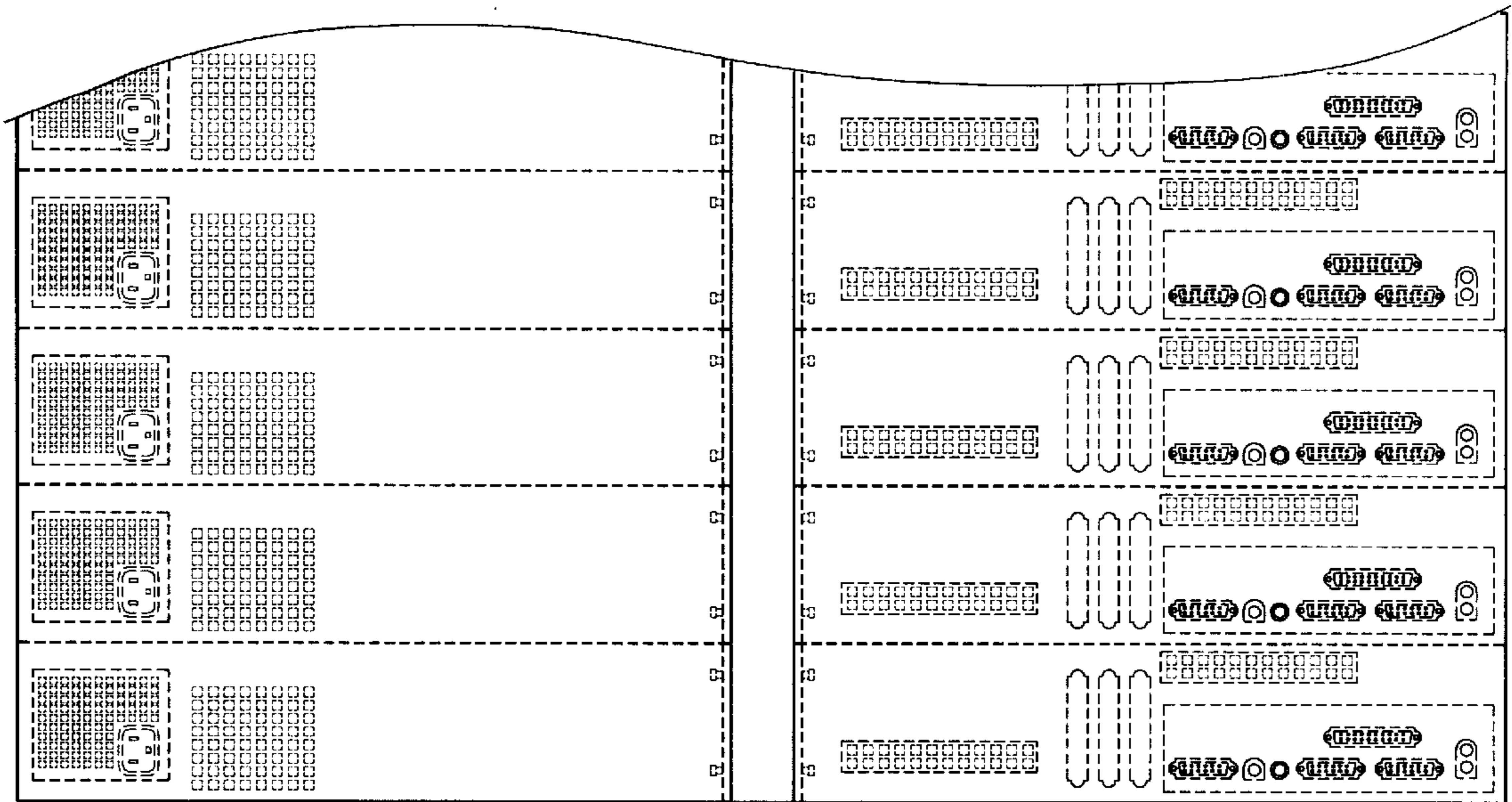

Figure 5

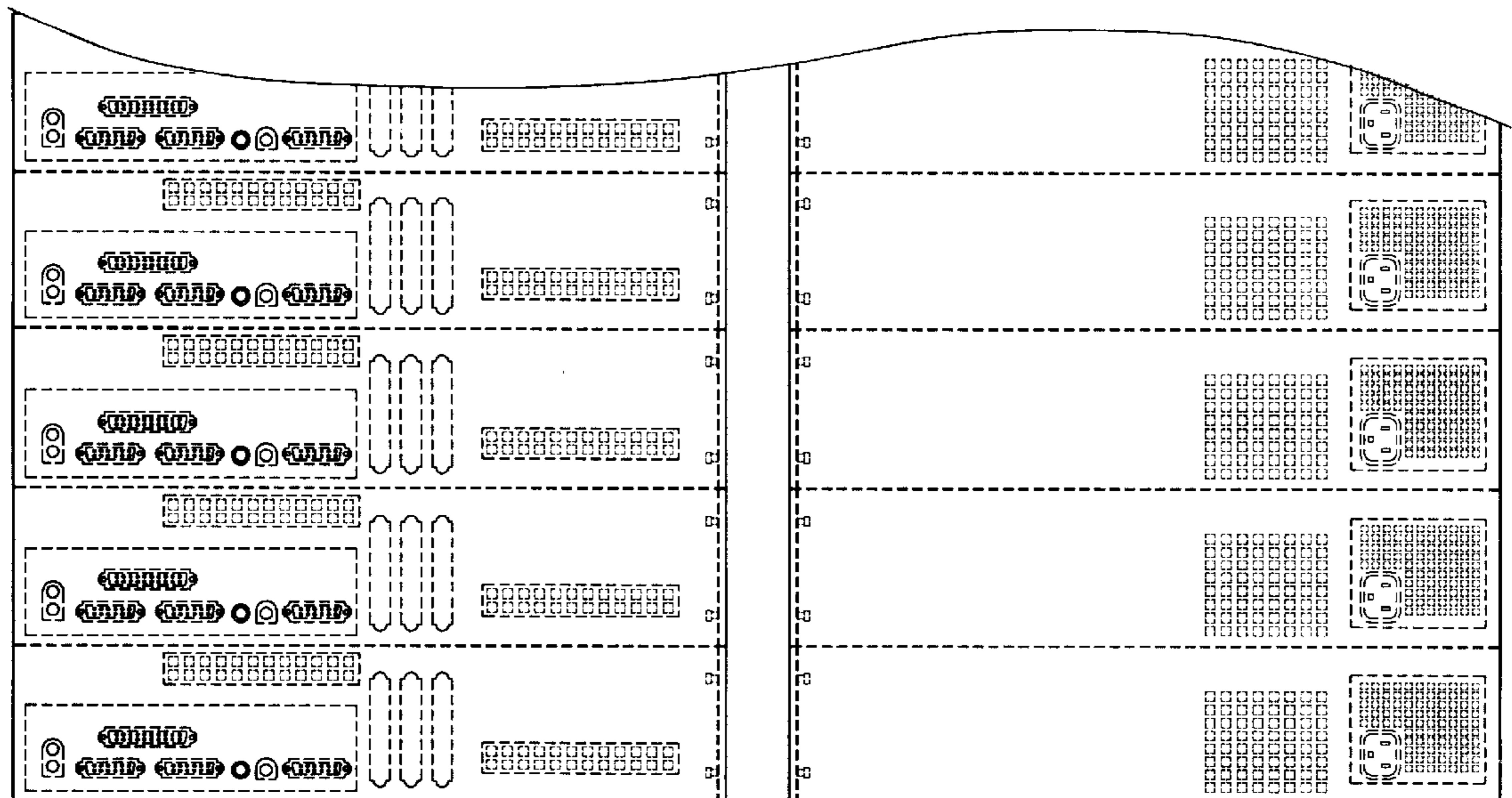

Figure 6

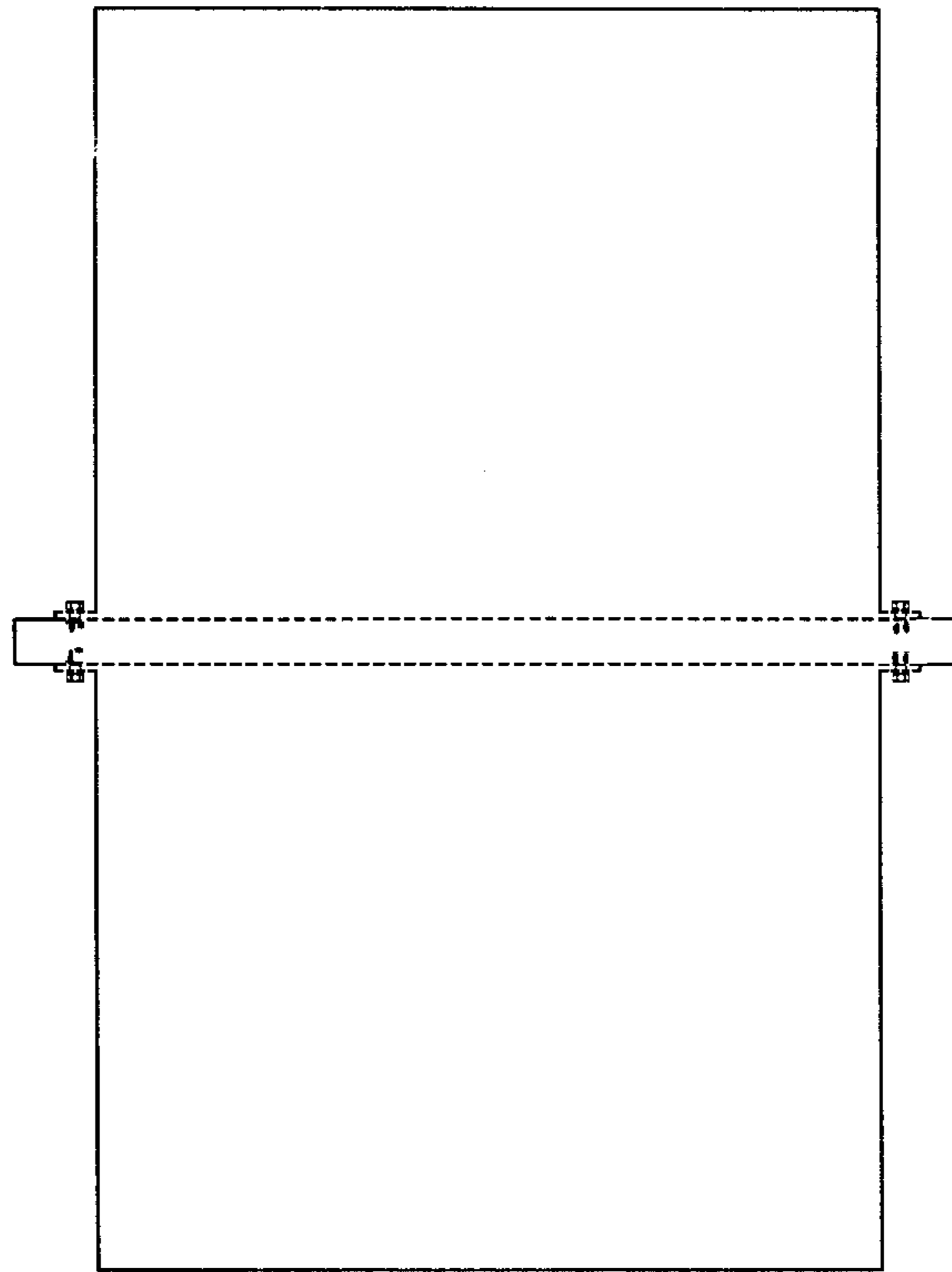

Figure 7

