



US00D473192S

(12) **United States Design Patent**
Ouchi et al.

(10) **Patent No.:** **US D473,192 S**

(45) **Date of Patent:** **** Apr. 15, 2003**

(54) **ELECTRIC CONNECTOR**

(75) Inventors: **Masashi Ouchi**, Ibaraki-ken (JP);
Takeshi Konno, Ibaraki-ken (JP);
Shuichi Sasajima, Ibaraki-ken (JP);
Tomohiro Mori, Ibaraki-ken (JP)

(73) Assignee: **Mitsumi Electric Co., Ltd.**, Tokyo (JP)

(**) Term: **14 Years**

(21) Appl. No.: **29/165,499**

(22) Filed: **Aug. 13, 2002**

(30) **Foreign Application Priority Data**

Feb. 14, 2002 (JP) 2002-003612

(51) **LOC (7) Cl.** **13-03**

(52) **U.S. Cl.** **D13/147**

(58) **Field of Search** D13/147, 120;
439/224, 660

(56) **References Cited**

U.S. PATENT DOCUMENTS

4,975,062 A * 12/1990 Evans et al. 439/13
5,551,883 A * 9/1996 Davis 439/660 X
D419,522 S * 1/2000 Kamagai D13/147 X

6,050,858 A * 4/2000 Liu et al. 439/660
6,068,518 A * 5/2000 McEuen 439/660
6,086,403 A * 7/2000 Po et al. 439/660 X
6,095,839 A * 8/2000 Kline 439/224
6,171,126 B1 * 1/2001 Wu et al. 439/224
D447,122 S * 8/2001 Harasawa et al. D13/147
2001/0034163 A1 * 10/2001 Chiang 439/660
2002/0049000 A1 * 4/2002 Tanaka et al. 439/660

* cited by examiner

Primary Examiner—Joel Sincavage

(74) *Attorney, Agent, or Firm*—Sughrue Mion, PLLC

(57) **CLAIM**

The ornamental design for an electric connector, as shown.

DESCRIPTION

FIG. 1 is a perspective view of the top, front and right side of an electric connector showing our new design;
FIG. 2 is a perspective view of the bottom, rear and left side thereof;
FIG. 3 is a top plan view thereof;
FIG. 4 is a front elevational view thereof;
FIG. 5 is a bottom plan view thereof;
FIG. 6 is a right side elevational view thereof; and,
FIG. 7 is a rear elevational view thereof.

1 Claim, 3 Drawing Sheets

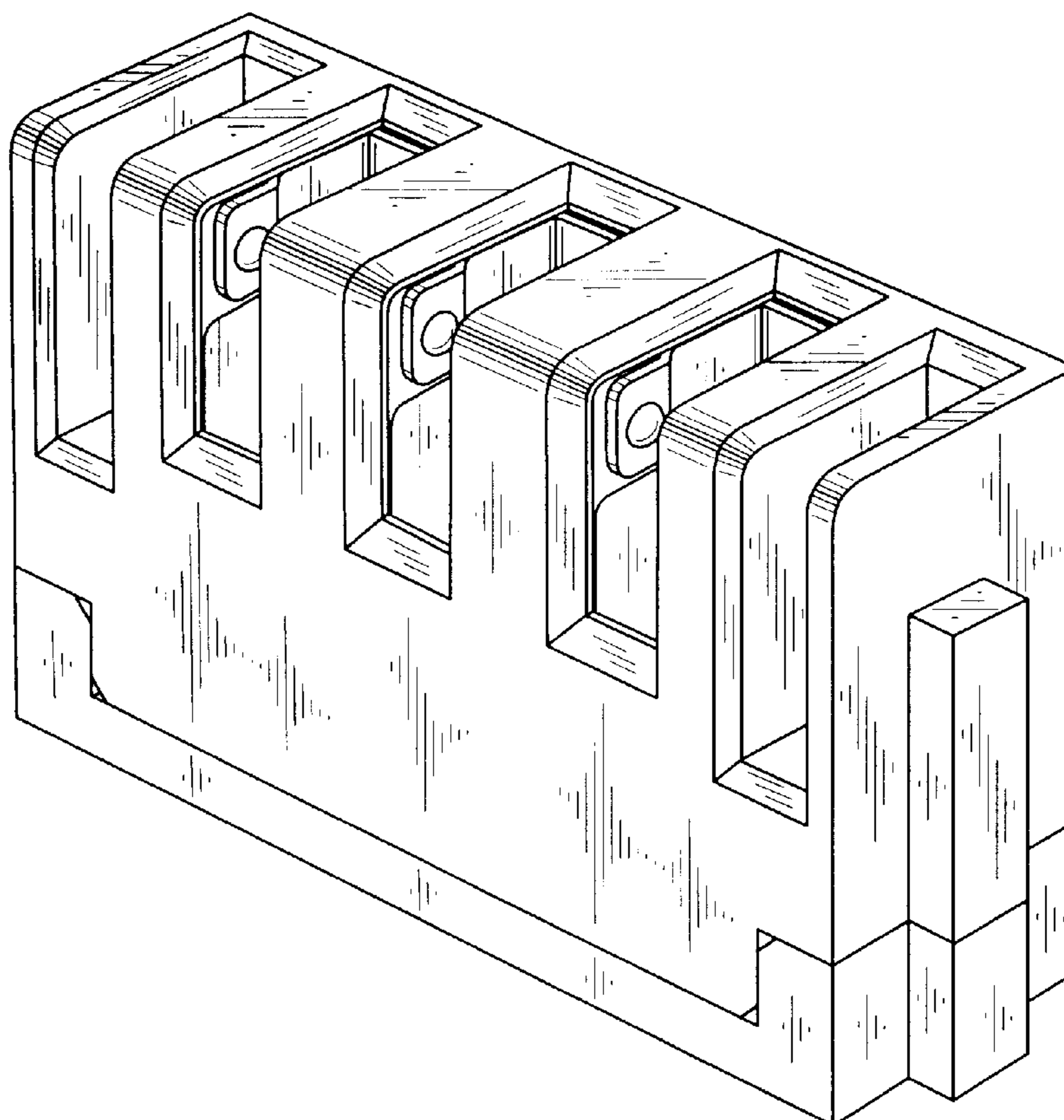

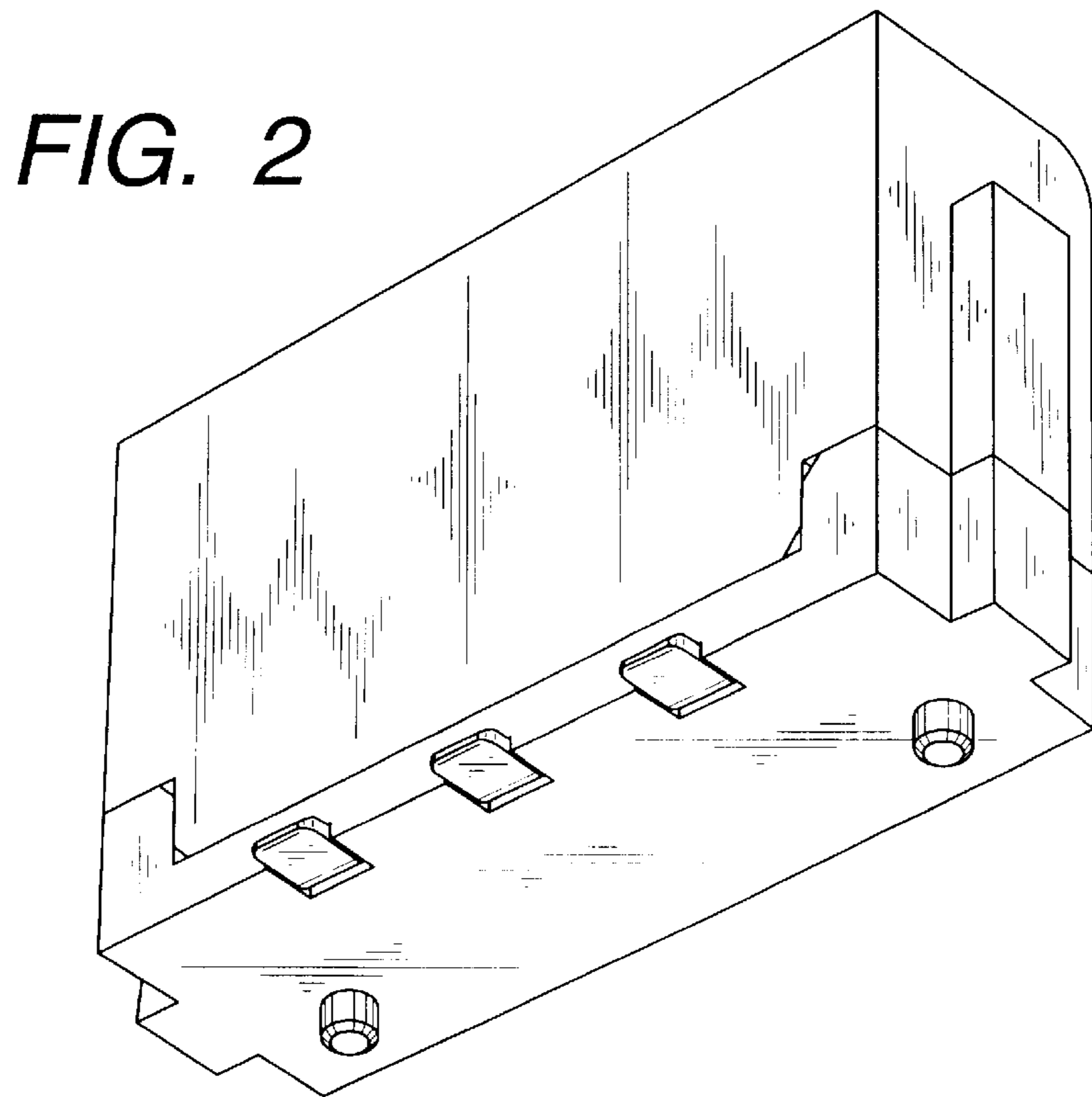
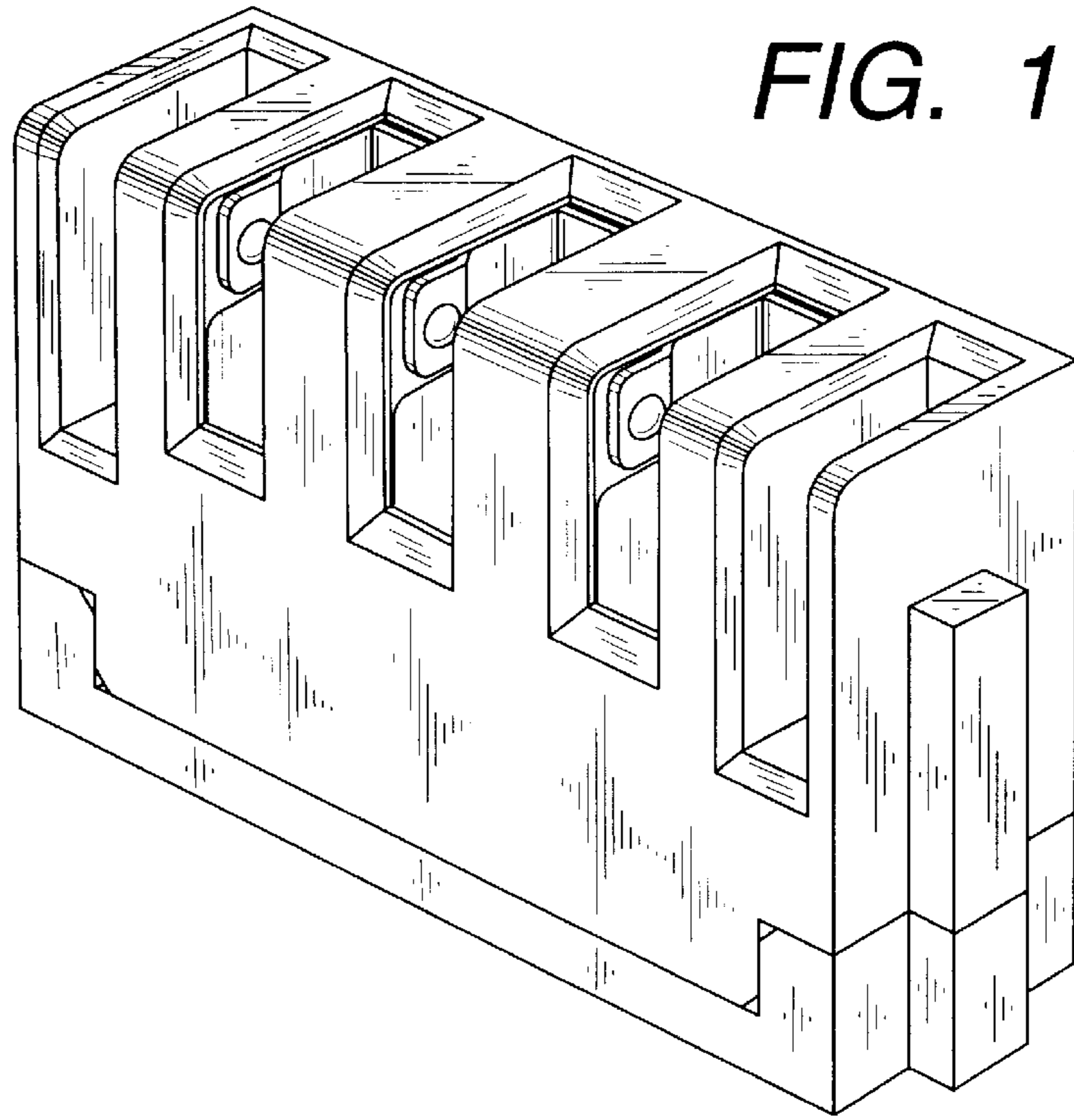

FIG. 3

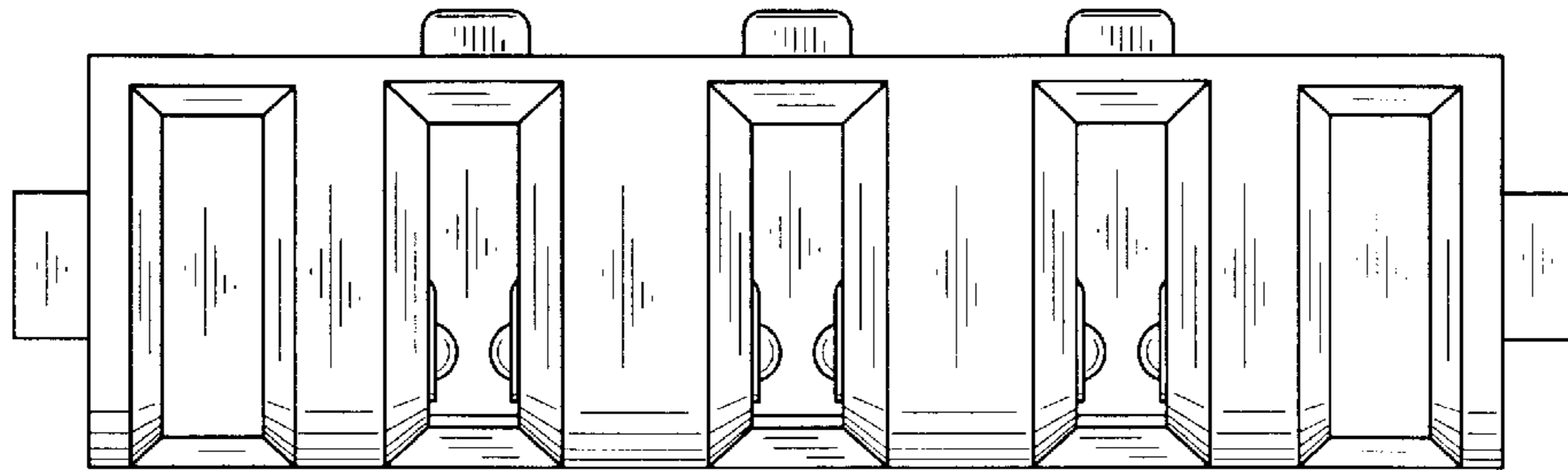

FIG. 4

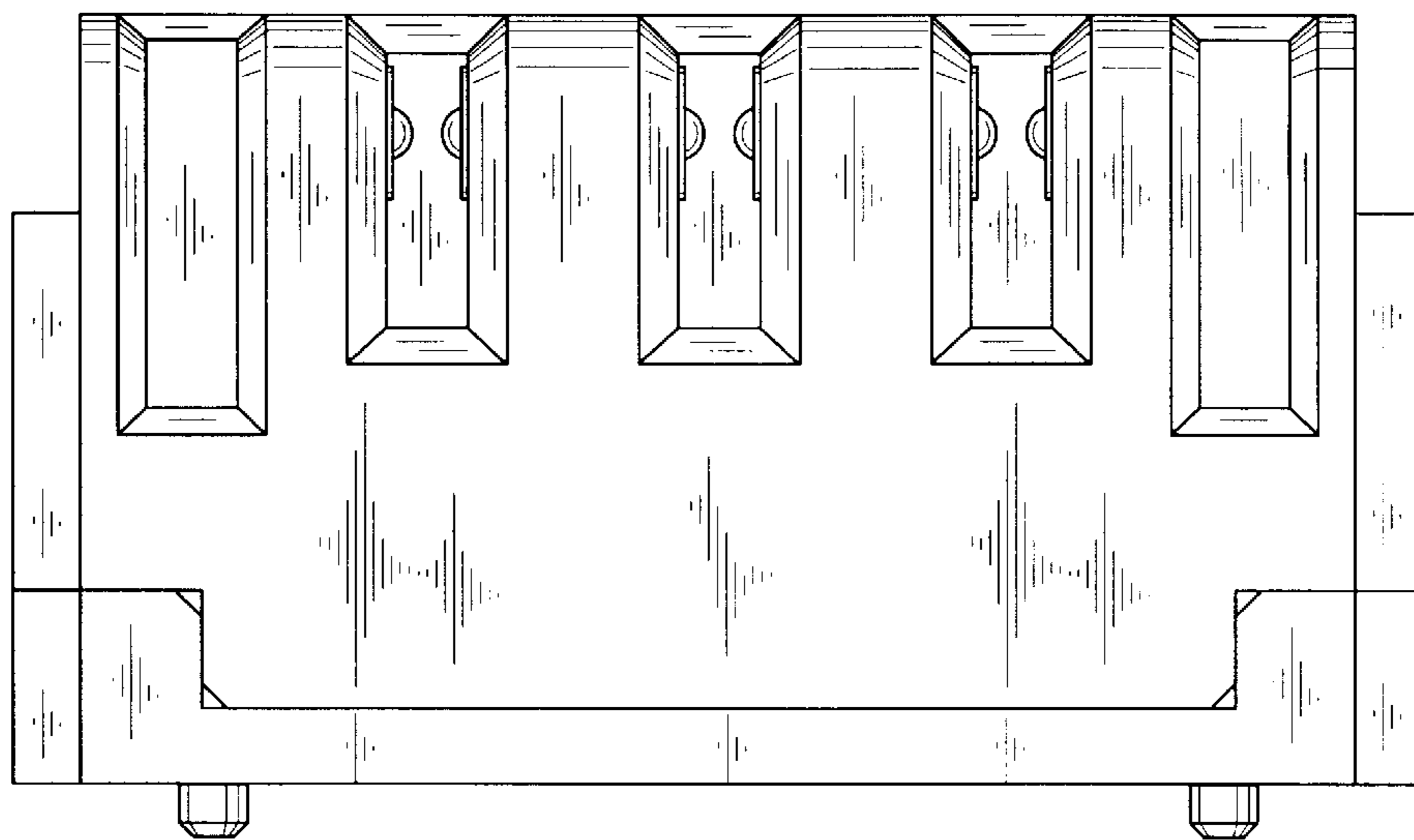

FIG. 5

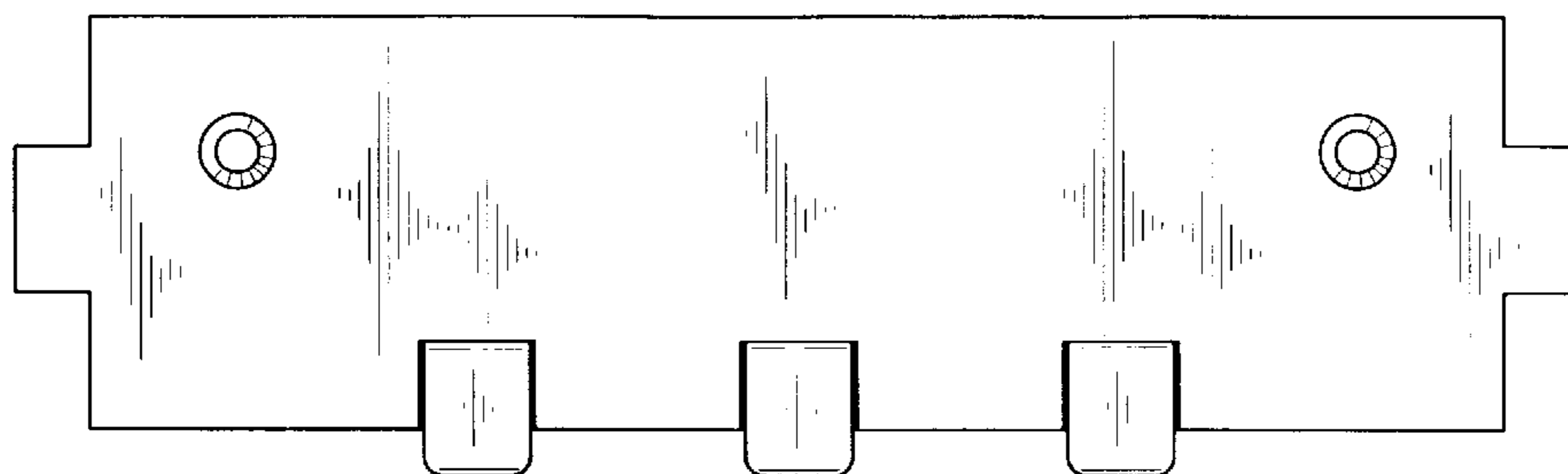

FIG. 6

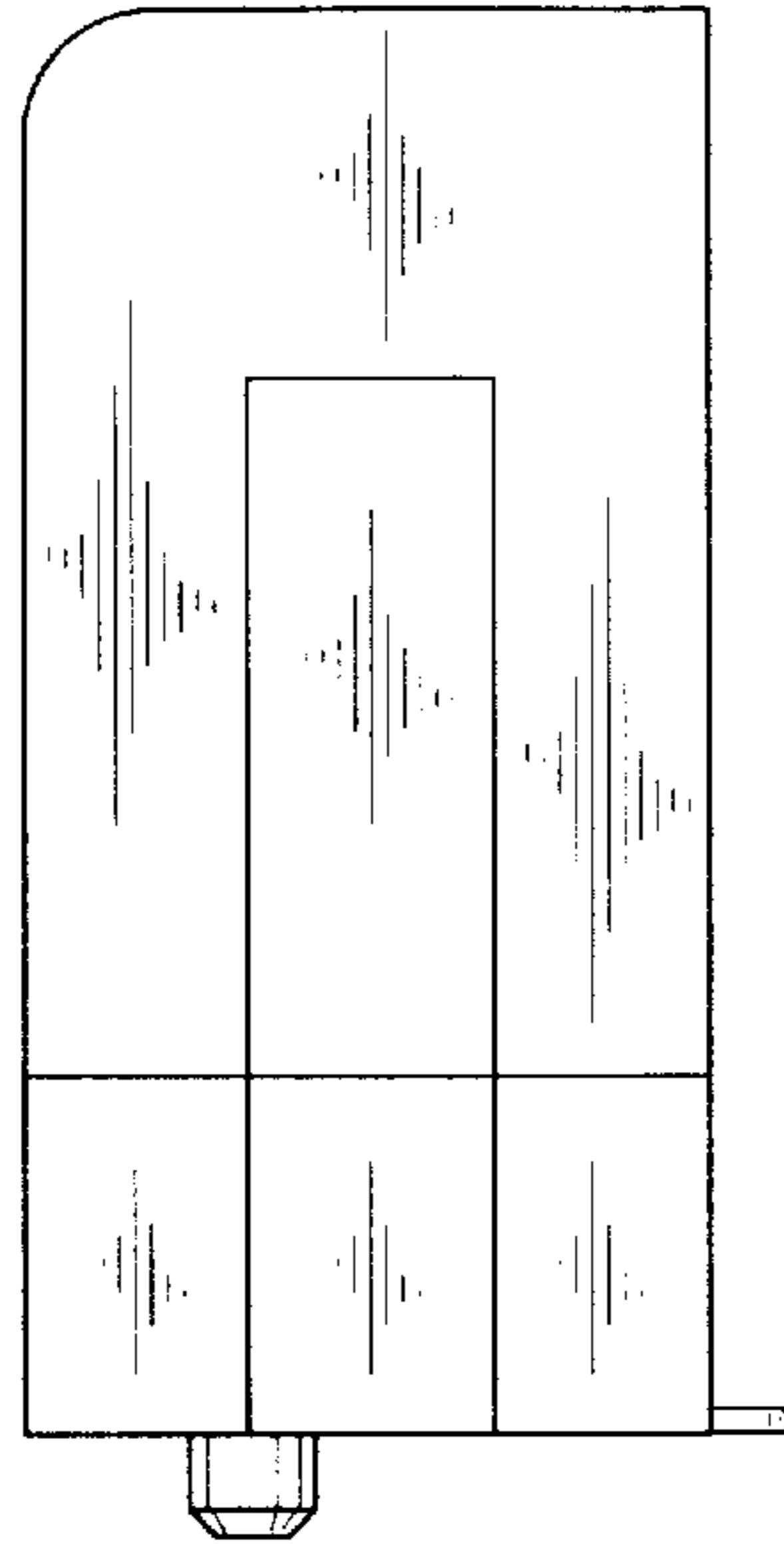

FIG. 7

