



US00D473100S

(12) **United States Design Patent**
Sakai et al.

(10) **Patent No.:** **US D473,100 S**

(45) **Date of Patent:** **** Apr. 15, 2003**

(54) **FOOD BLENDER**

(75) Inventors: **Akihiko Sakai**, Kyoto-fu (JP); **Miki Choya**, Osaka-fu (JP)

(73) Assignee: **Sharp Kabushiki Kaisha**, Osaka (JP)

(**) Term: **14 Years**

(21) Appl. No.: **29/167,688**

(22) Filed: **Sep. 20, 2002**

(30) **Foreign Application Priority Data**

Mar. 20, 2002 (JP) 2002-007313

(51) **LOC (7) Cl.** **31-00**

(52) **U.S. Cl.** **D7/378**

(58) **Field of Search** D7/376-378, 384,
D7/386; 366/64, 197, 199, 205, 206, 219,
241, 244, 314; 241/33, 301, 285.2

(56) **References Cited**

U.S. PATENT DOCUMENTS

D466,362 S * 12/2002 Moore D7/378

* cited by examiner

Primary Examiner—Caron D. Veynar

(74) *Attorney, Agent, or Firm*—Nixon & Vanderhye

(57) **CLAIM**

The ornamental design for a “food blender,” as shown and described.

DESCRIPTION

FIG. 1 is a front and right side perspective view of a food blender according to our design;

FIG. 2 is a front elevational view thereof;

FIG. 3 is a rear elevational view thereof;

FIG. 4 is a top plan view thereof;

FIG. 5 is a bottom plan view thereof;

FIG. 6 is a right side elevational view thereof; and,

FIG. 7 is a left side elevational view thereof.

1 Claim, 6 Drawing Sheets

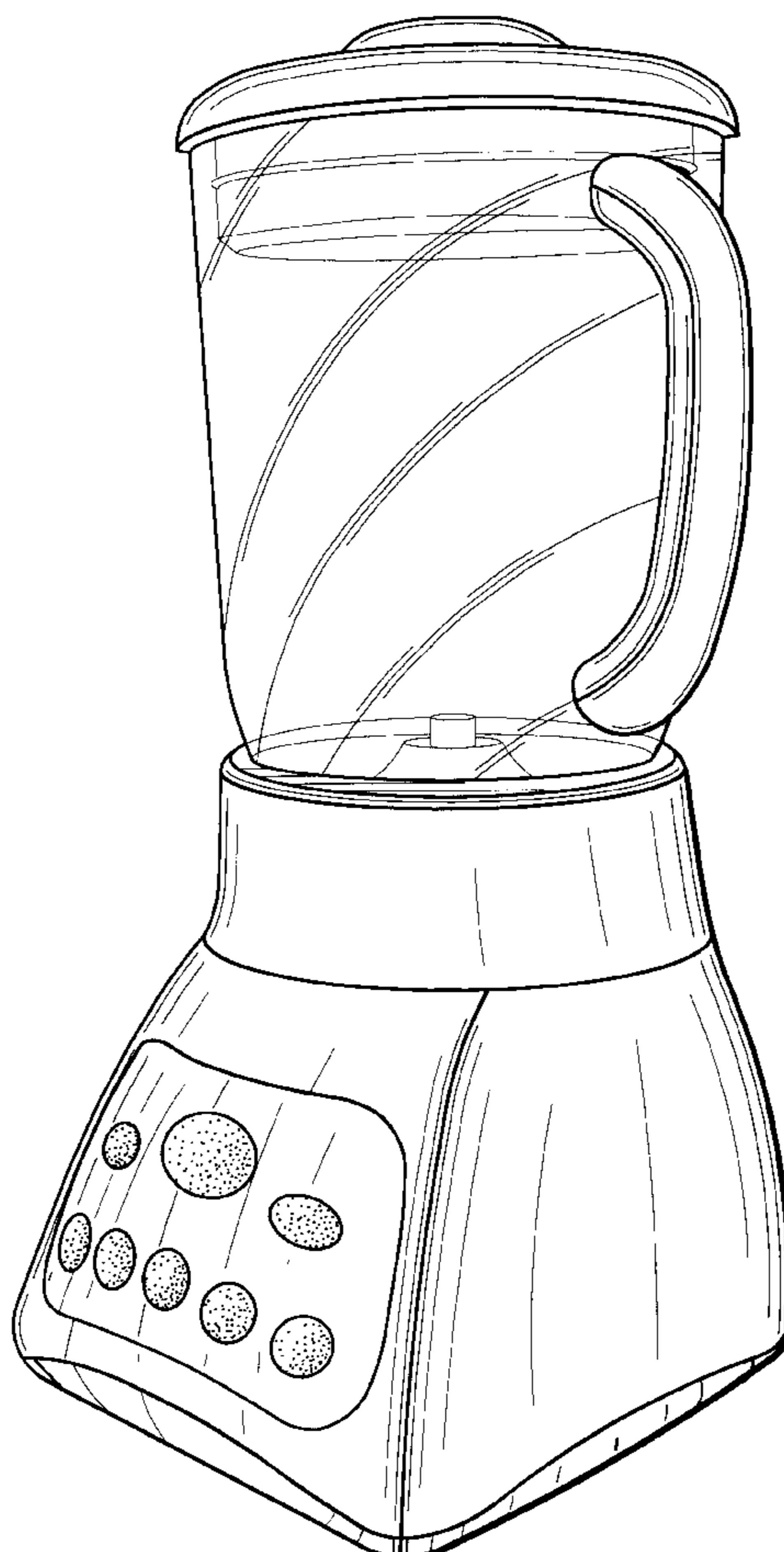

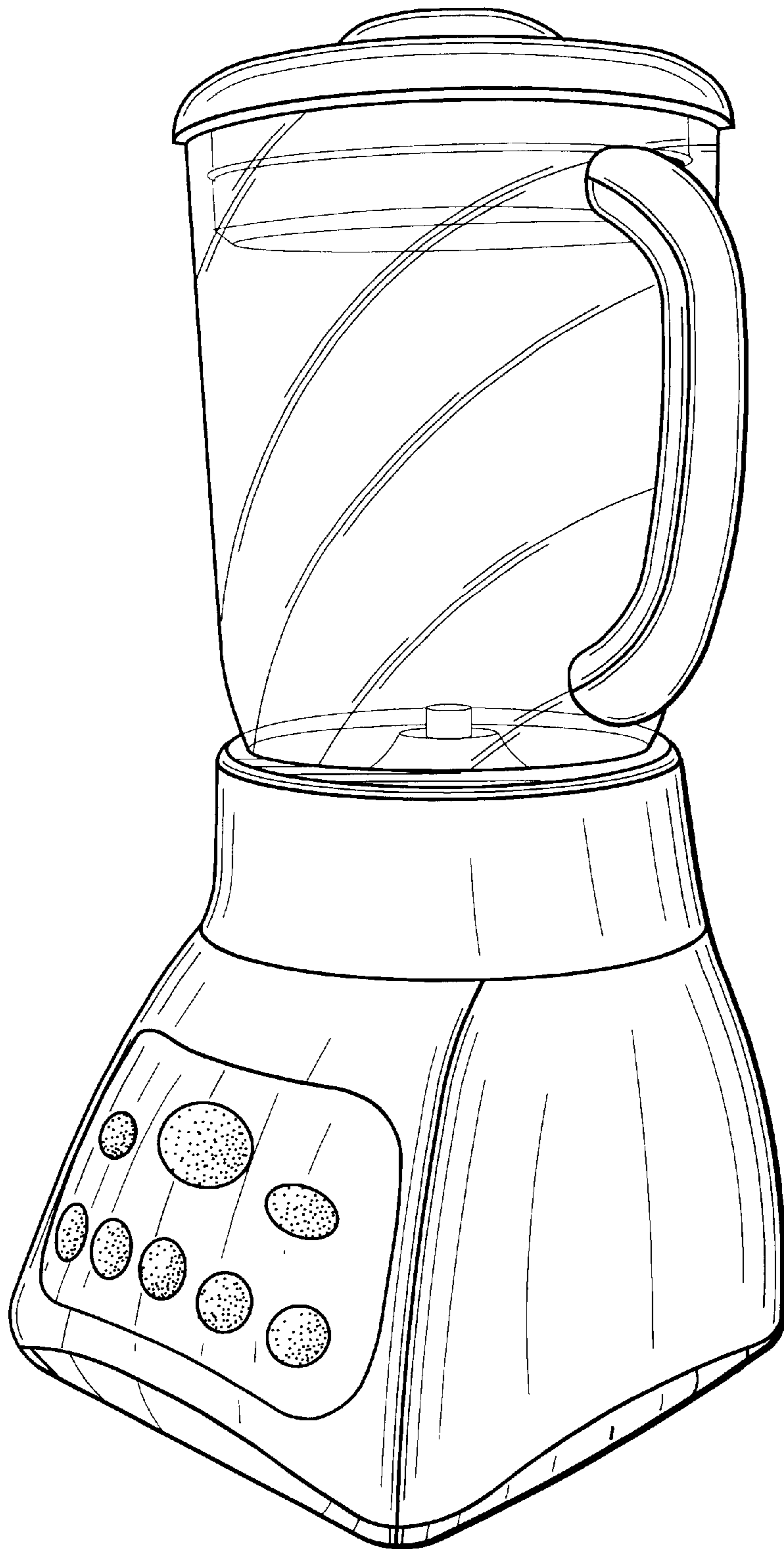

Fig.1

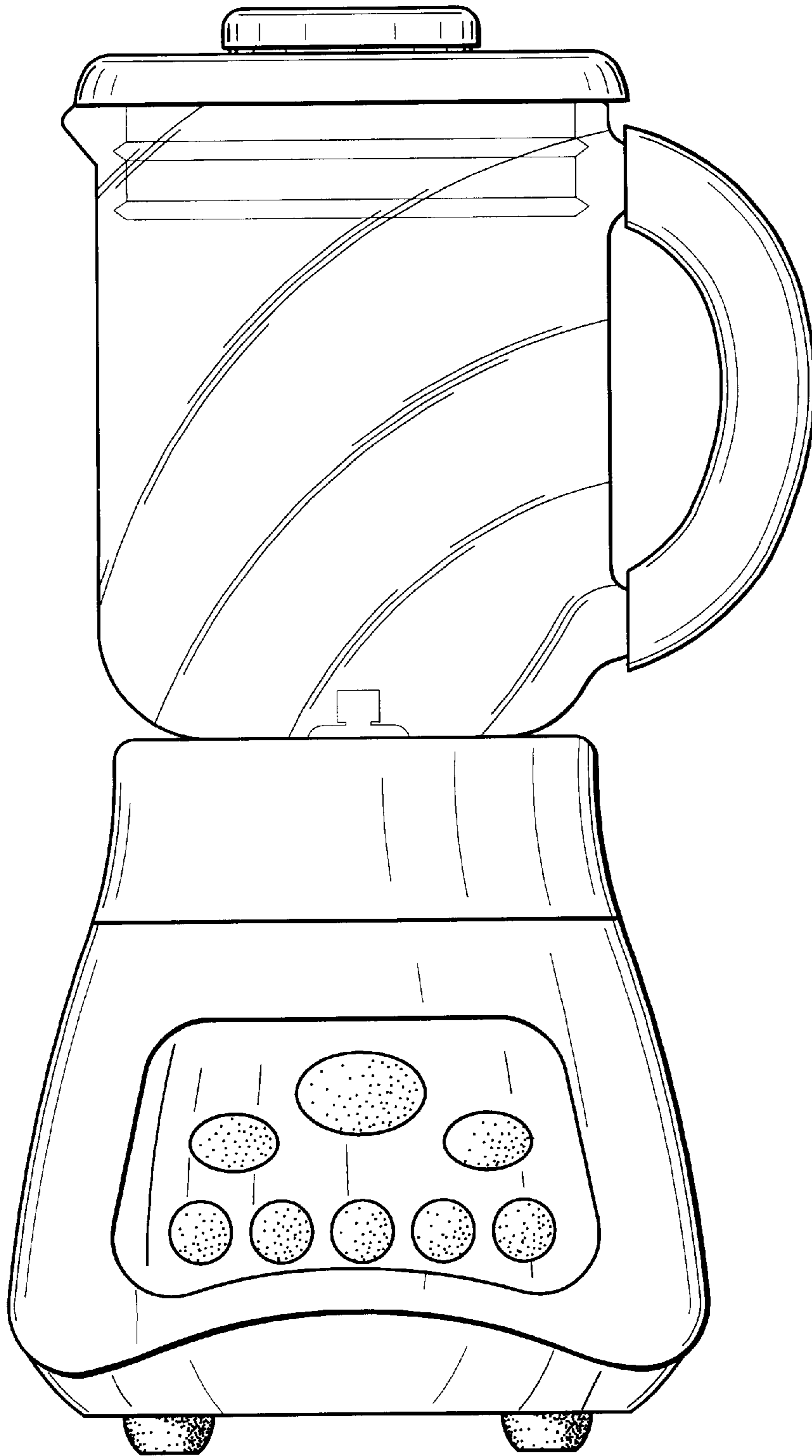

Fig.2

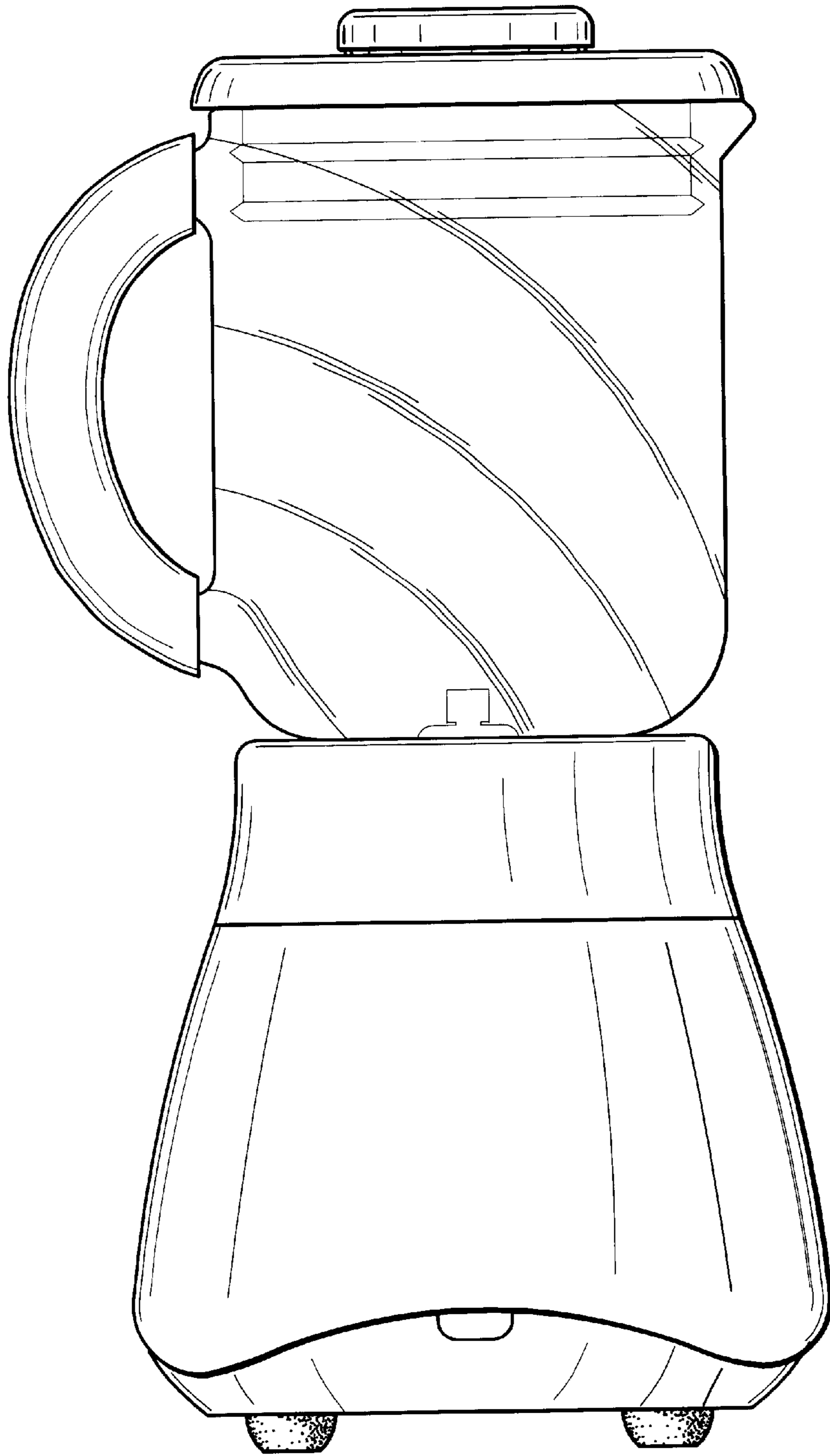

Fig.3

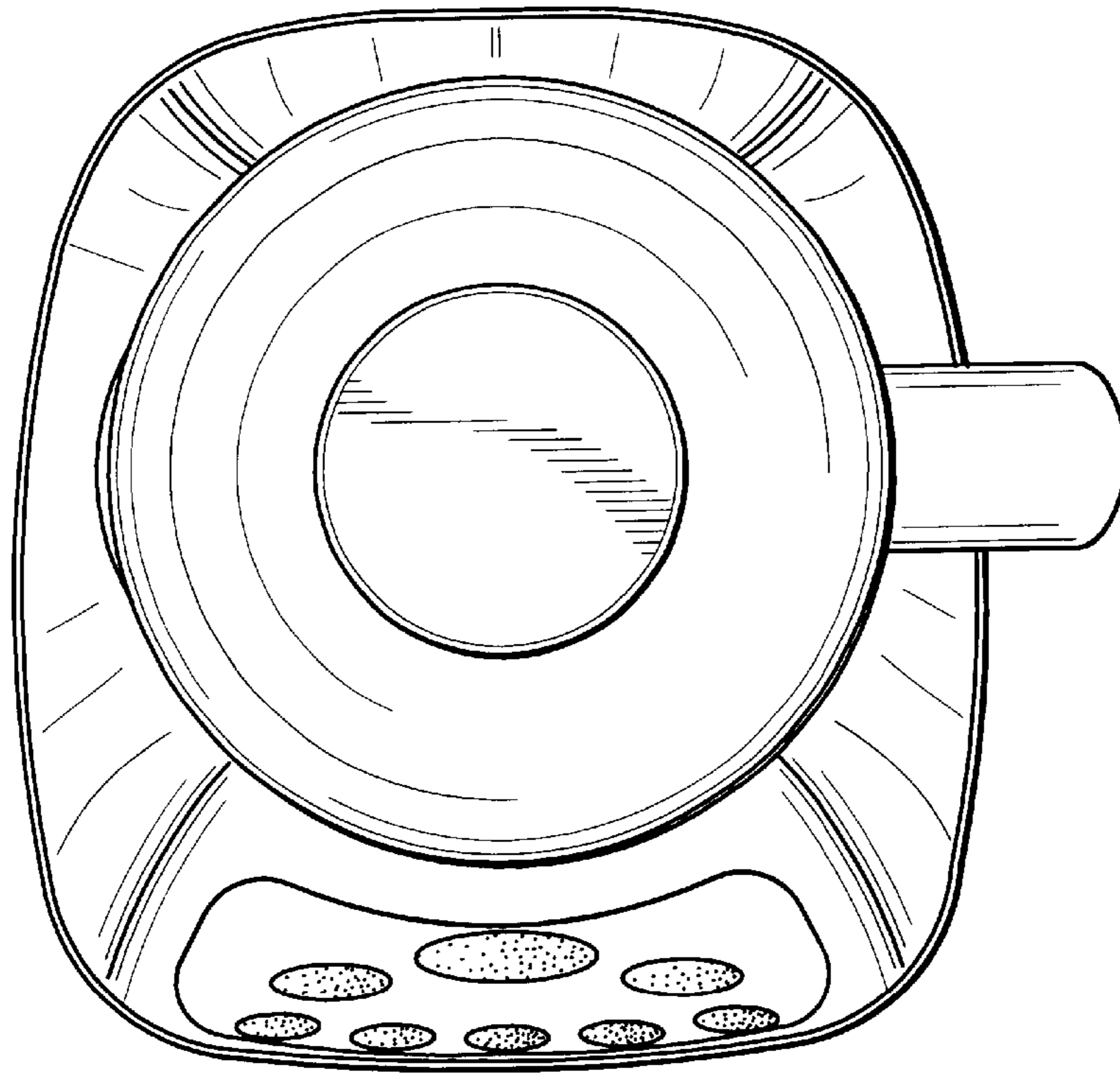

Fig.4

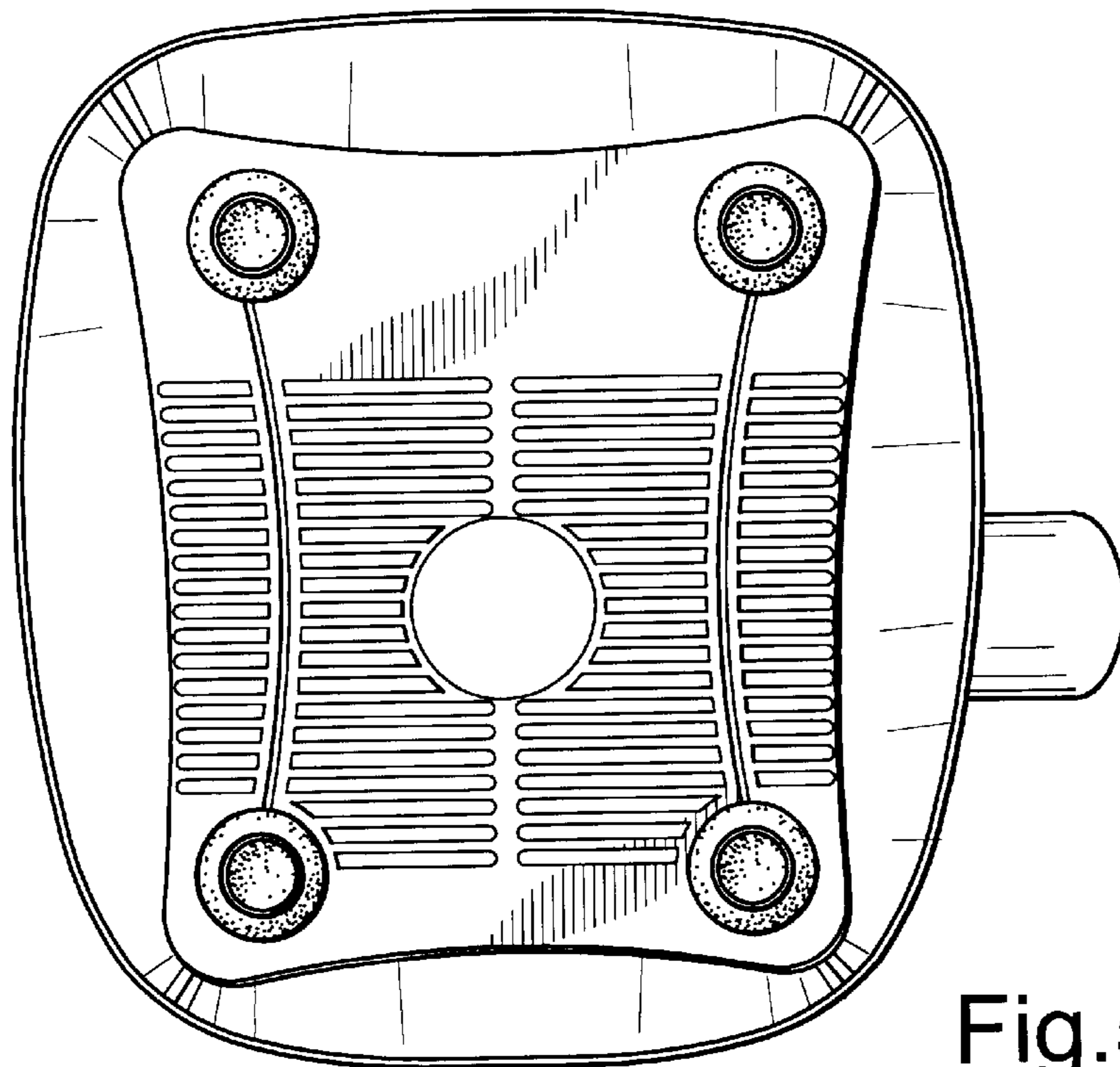

Fig.5

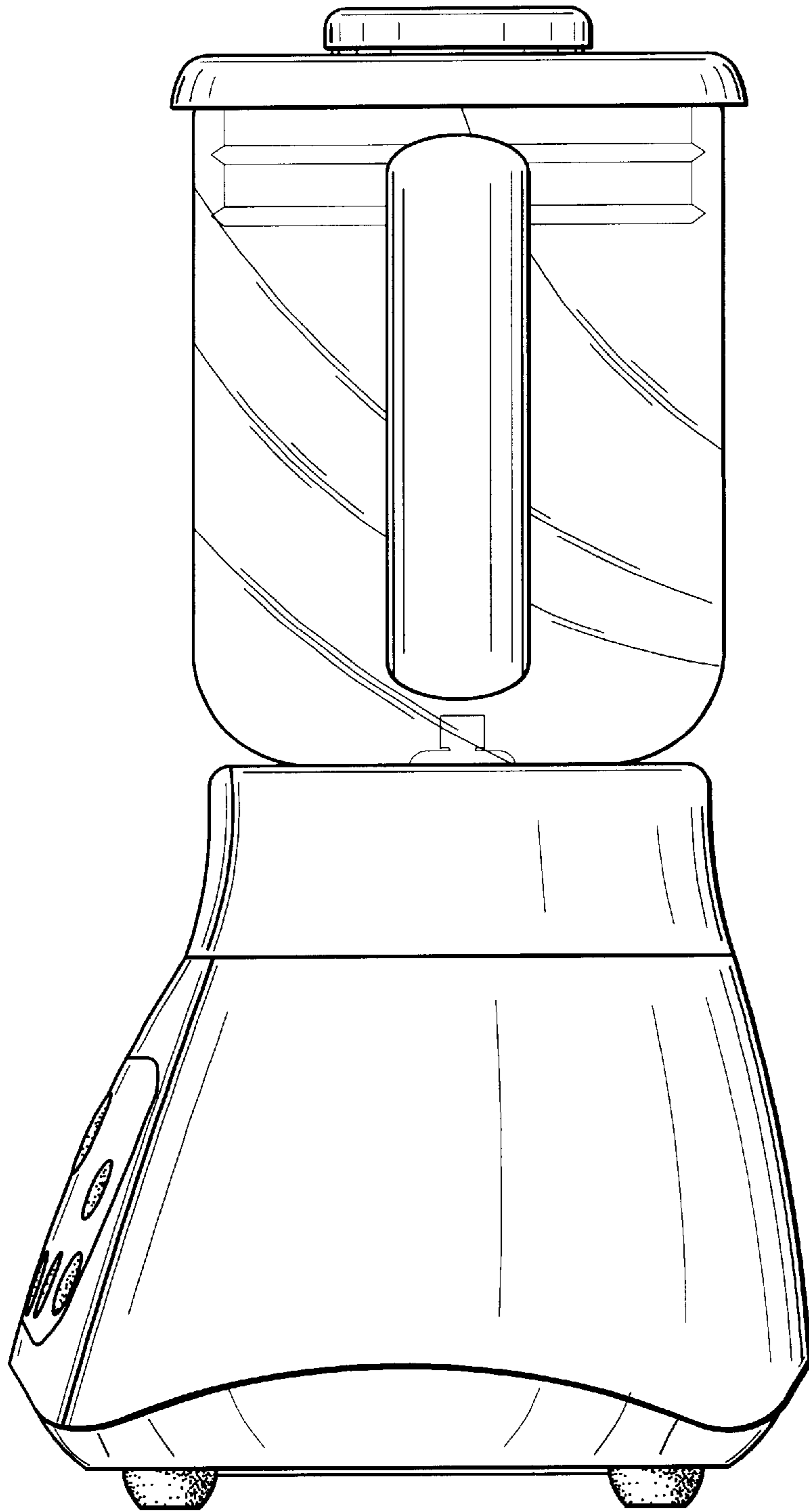

Fig.6

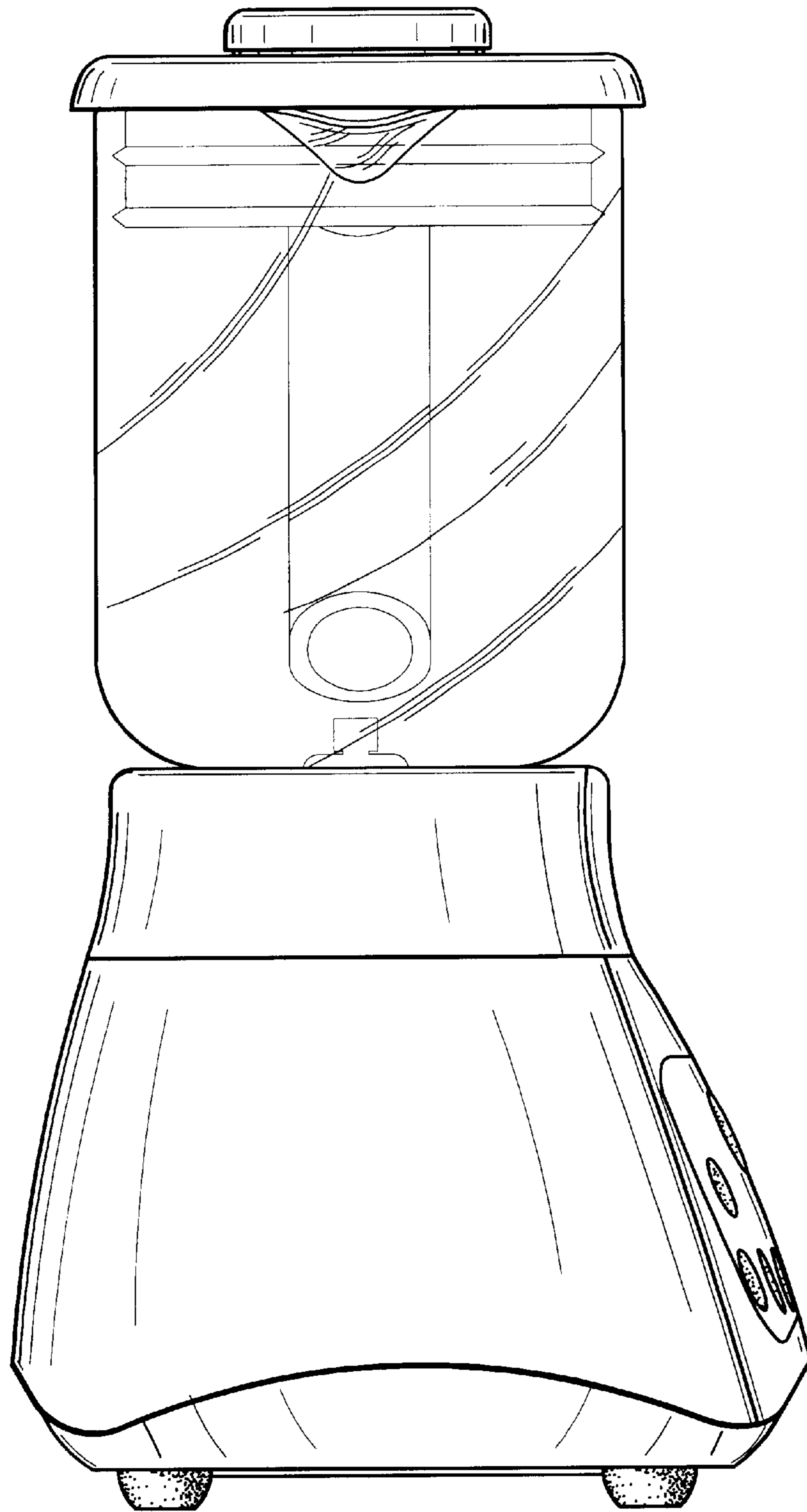

Fig.7