



US00D473055S

(12) **United States Design Patent**  
**Mann**

(10) **Patent No.:** **US D473,055 S**

(45) **Date of Patent:** **\*\* Apr. 15, 2003**

(54) **PAINT ROLLER FRAME CAGE**

(75) Inventor: **David G. Mann**, Shreve, OH (US)

(73) Assignee: **The Wooster Brush Company**,  
Wooster, OH (US)

(\*\*) Term: **14 Years**

(21) Appl. No.: **29/150,545**

(22) Filed: **Nov. 19, 2001**

(51) **LOC (7) Cl.** ..... **08-05**

(52) **U.S. Cl.** ..... **D4/122**

(58) **Field of Search** ..... D4/122, 199; 15/230.11;  
492/13, 16-19

(56) **References Cited**

**U.S. PATENT DOCUMENTS**

4,209,883	A	*	7/1980	Hawk	.....	492/19
D291,152	S	*	8/1987	Bay	.....	D4/122
5,490,303	A		2/1996	Graves		
5,611,100	A		3/1997	Zigelboim et al.		
5,806,129	A		9/1998	Nelson		
5,979,009	A		11/1999	Polzin et al.		
6,117,494	A	*	9/2000	Wakat	.....	D4/122 X
6,438,788	B1	*	8/2002	Gartner	.....	15/230.11

**FOREIGN PATENT DOCUMENTS**

DE 3903519 \* 8/1990 ..... B05C/17/02

**OTHER PUBLICATIONS**

Zip Roller System, Dec. 21, 1993 (2 pages).

\* cited by examiner

*Primary Examiner*—Alan P. Douglas

*Assistant Examiner*—Lavone D. Tabor

(74) *Attorney, Agent, or Firm*—Renner, Otto, Boisselle & Sklar, LLP

(57) **CLAIM**

The ornamental design for a paint roller frame cage, as shown and described.

**DESCRIPTION**

FIG. 1 is a perspective view of one embodiment of a paint roller frame cage showing my new design as seen from the outboard end thereof;

FIG. 2 is an enlarged top plan view thereof, the bottom plan view being a mirror image;

FIG. 3 is an enlarged front side elevation view thereof, the back side being a mirror image;

FIG. 4 is an enlarged right end elevation view thereof;

FIG. 5 is an enlarged left end elevation view thereof;

FIG. 6 is a top plan view of a second embodiment of a paint roller frame cage showing my new design, the bottom plan view being a mirror image;

FIG. 7 is a front side elevation view of the paint roller frame cage of FIG. 6, the back side being a mirror image;

FIG. 8 is a right end elevation view of the paint roller frame cage of FIG. 6;

FIG. 9 is a left end elevation view of the paint roller frame cage of FIG. 6;

FIG. 10 is a top plan view of a third embodiment of a paint roller frame cage showing my new design, the bottom plan view being a mirror image;

FIG. 11 is a front side elevation view of the paint roller frame cage of FIG. 10, the back side being a mirror image;

FIG. 12 is a right end elevation view of the paint roller frame cage of FIG. 10; and,

FIG. 13 is a left end elevation view of the paint roller frame cage of FIG. 10.

The broken line showing of the wire frame and handle in FIG. 1 and the wire frame in FIGS. 2, 3, 6, 7, 10 and 11 is for illustrative purposes only and forms no part of the claimed design.

**1 Claim, 4 Drawing Sheets**

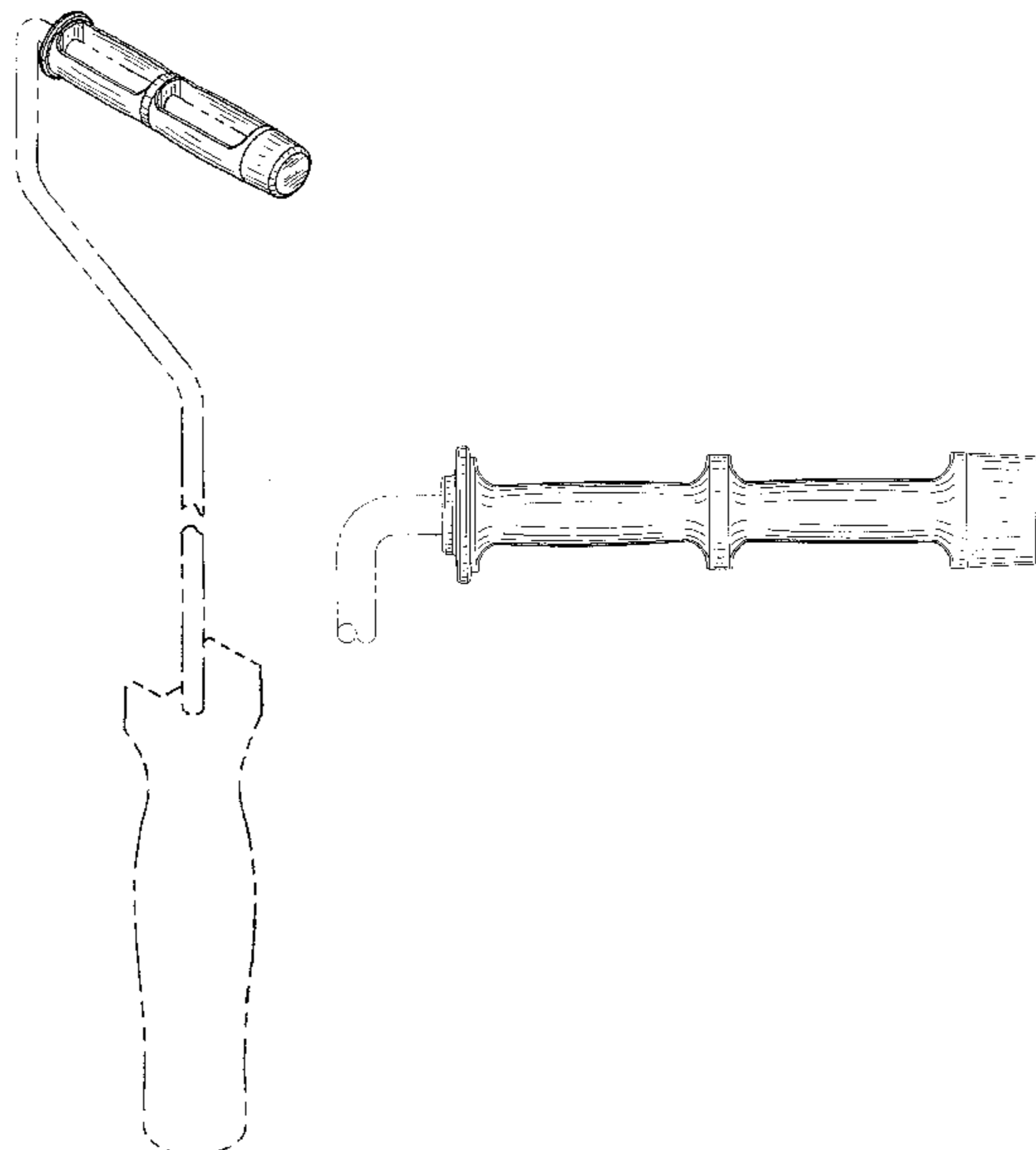

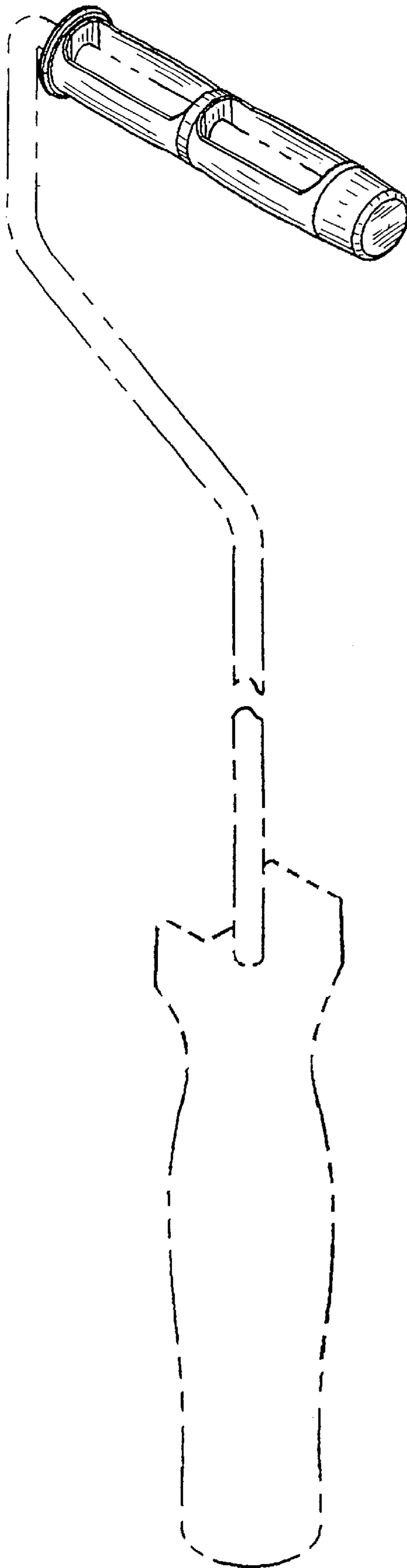

FIG. 1

FIG. 2

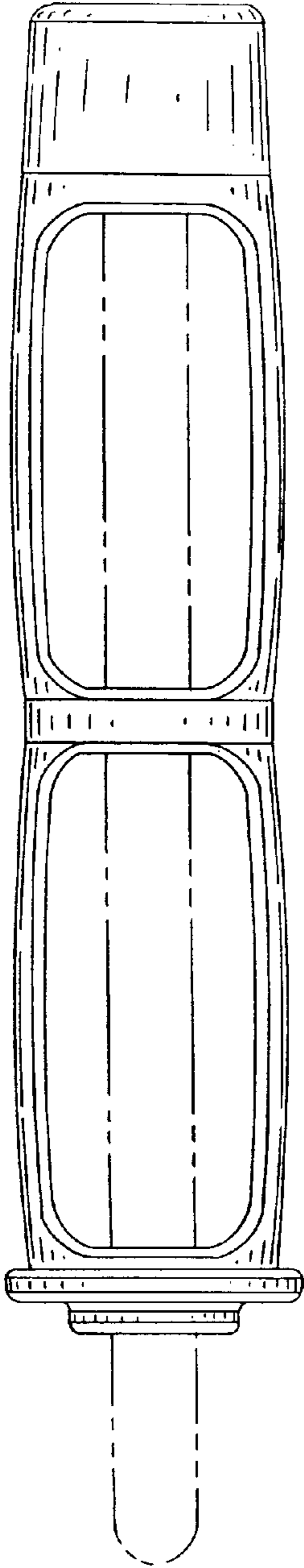

FIG. 3

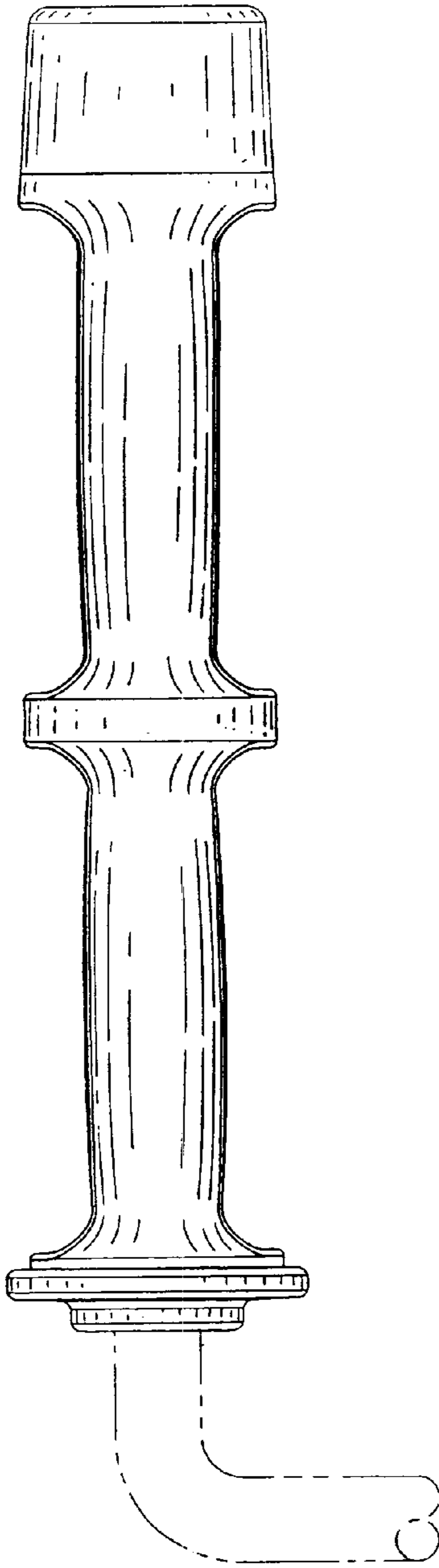

FIG. 4

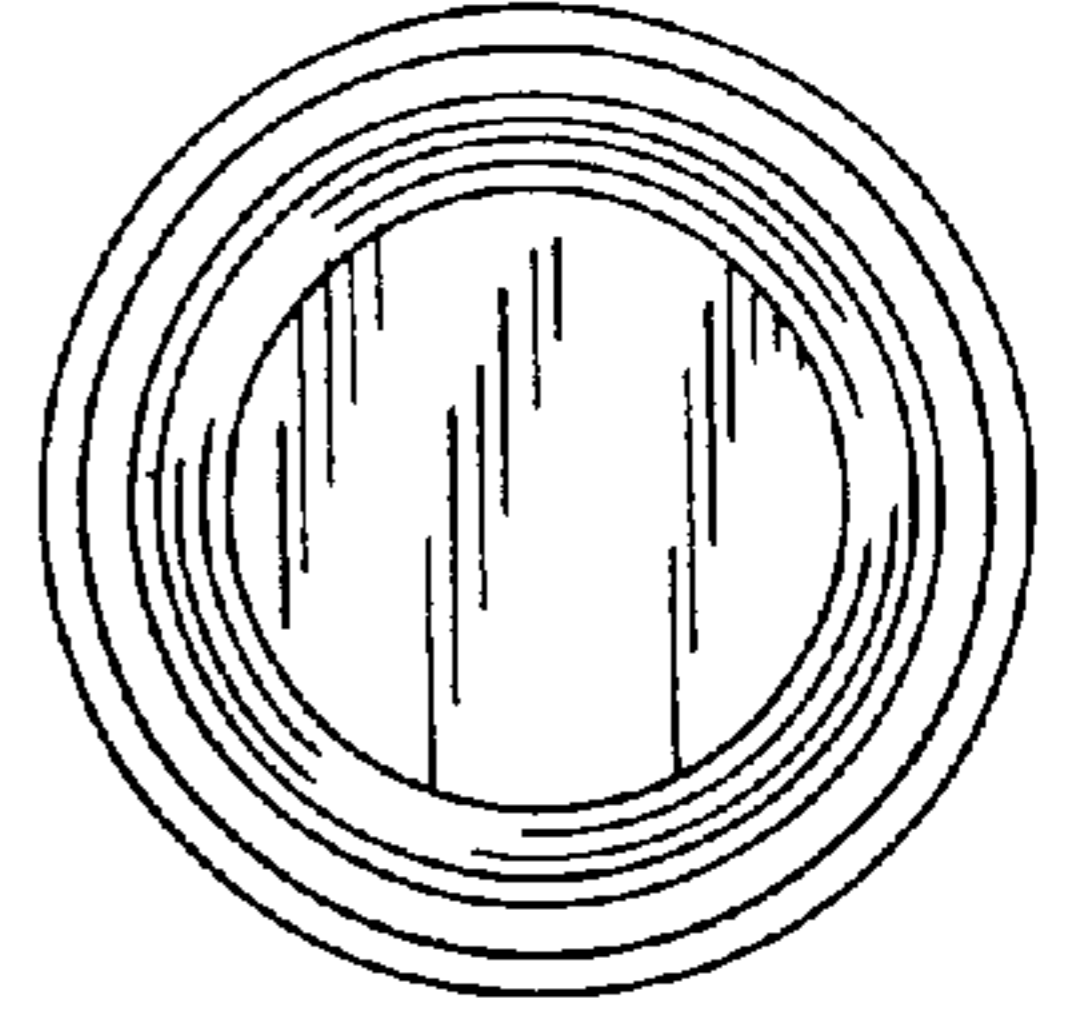
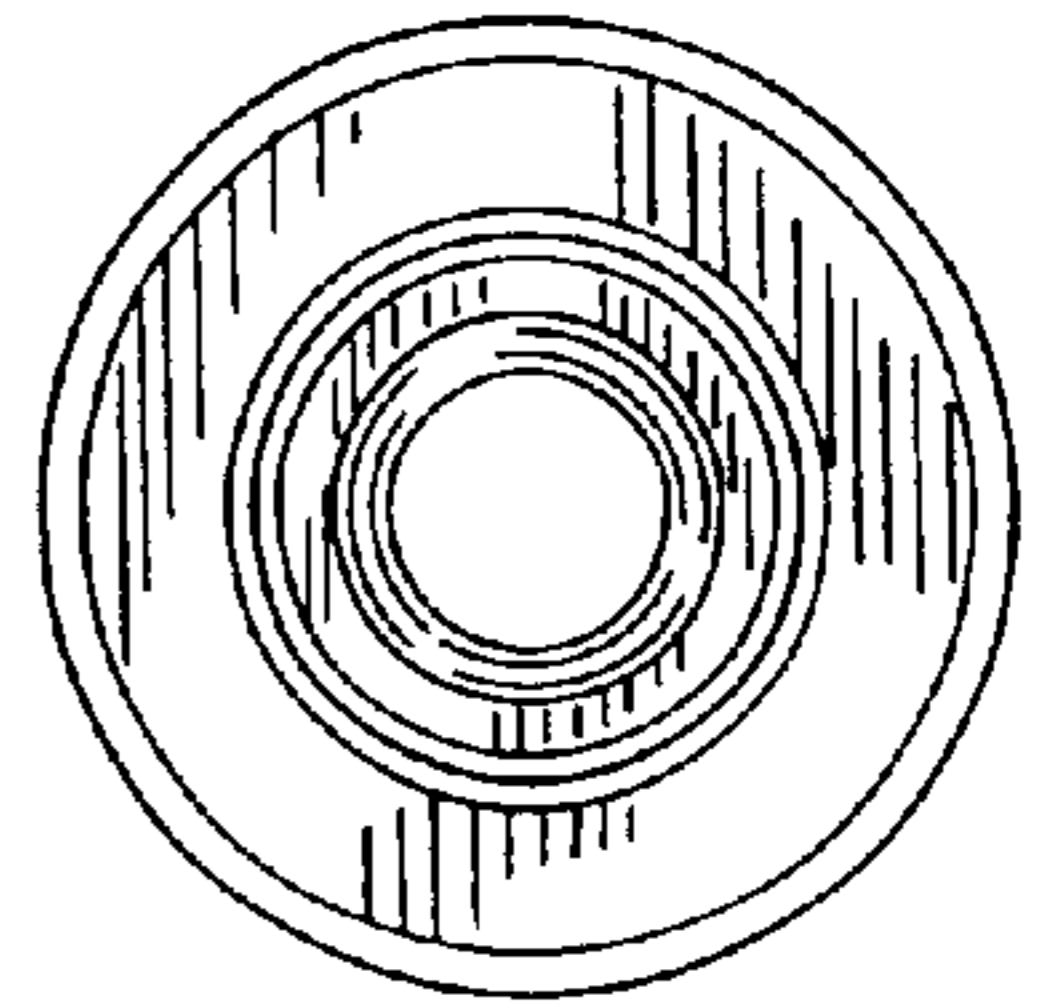

FIG. 5



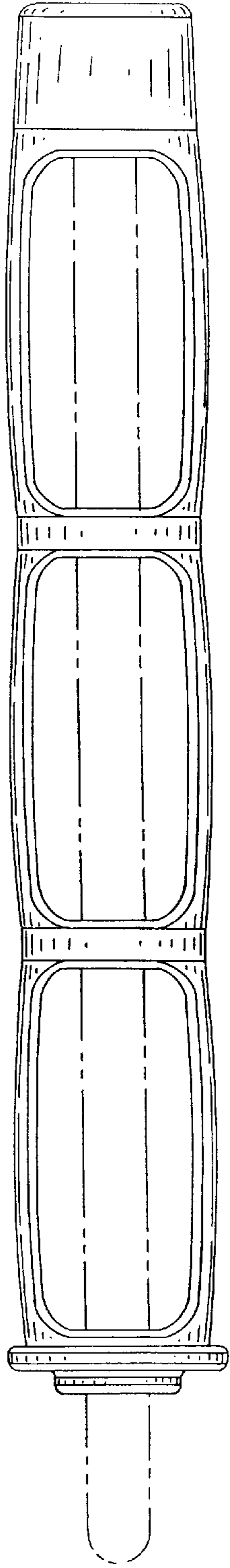

FIG. 6

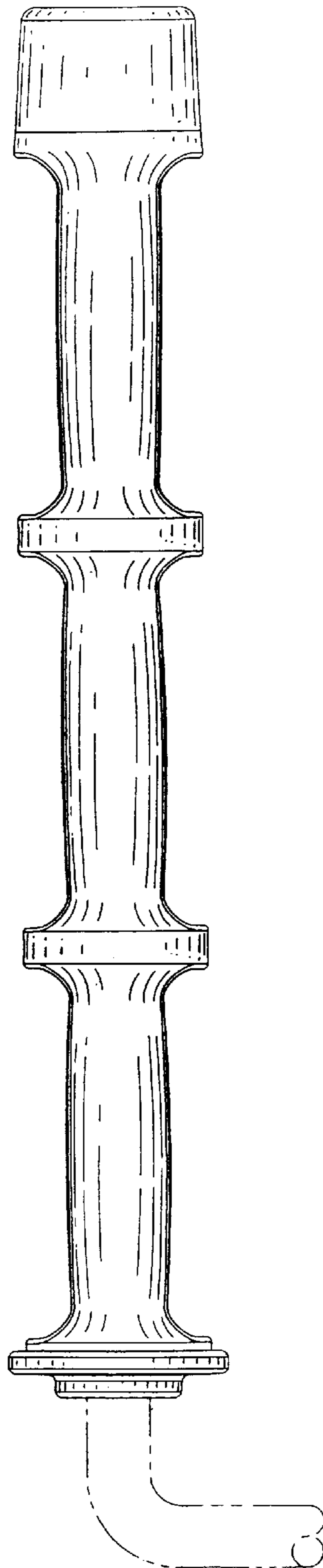

FIG. 7

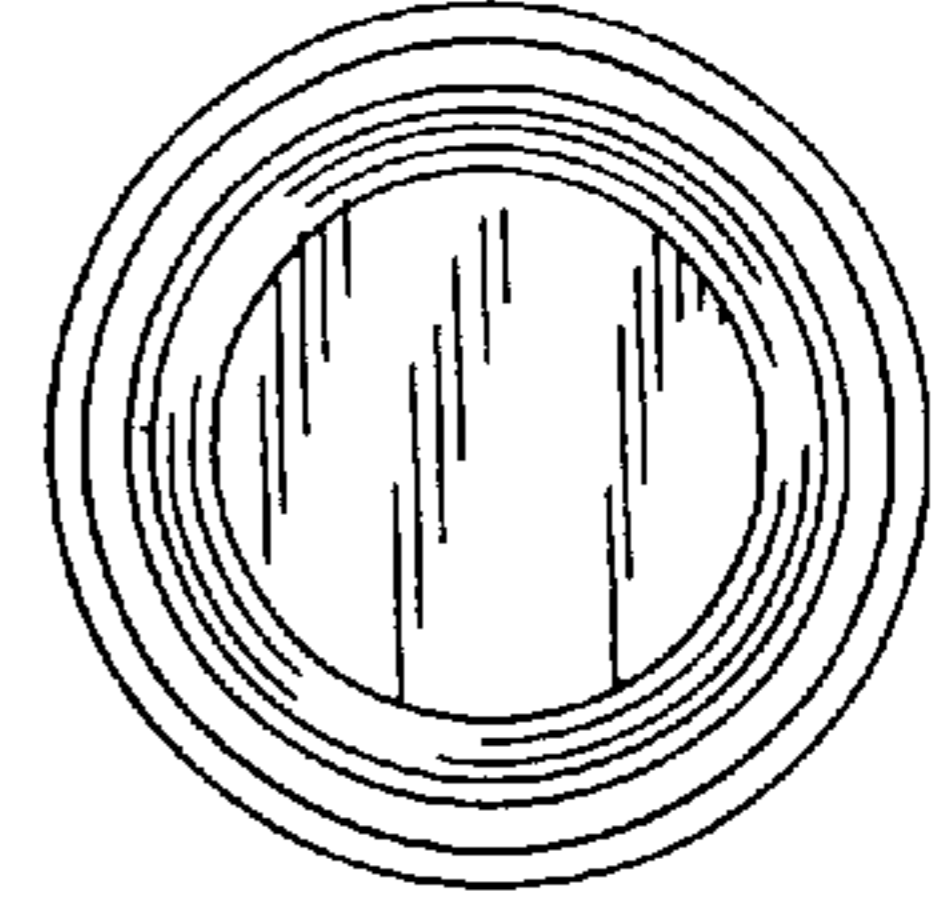

FIG. 8

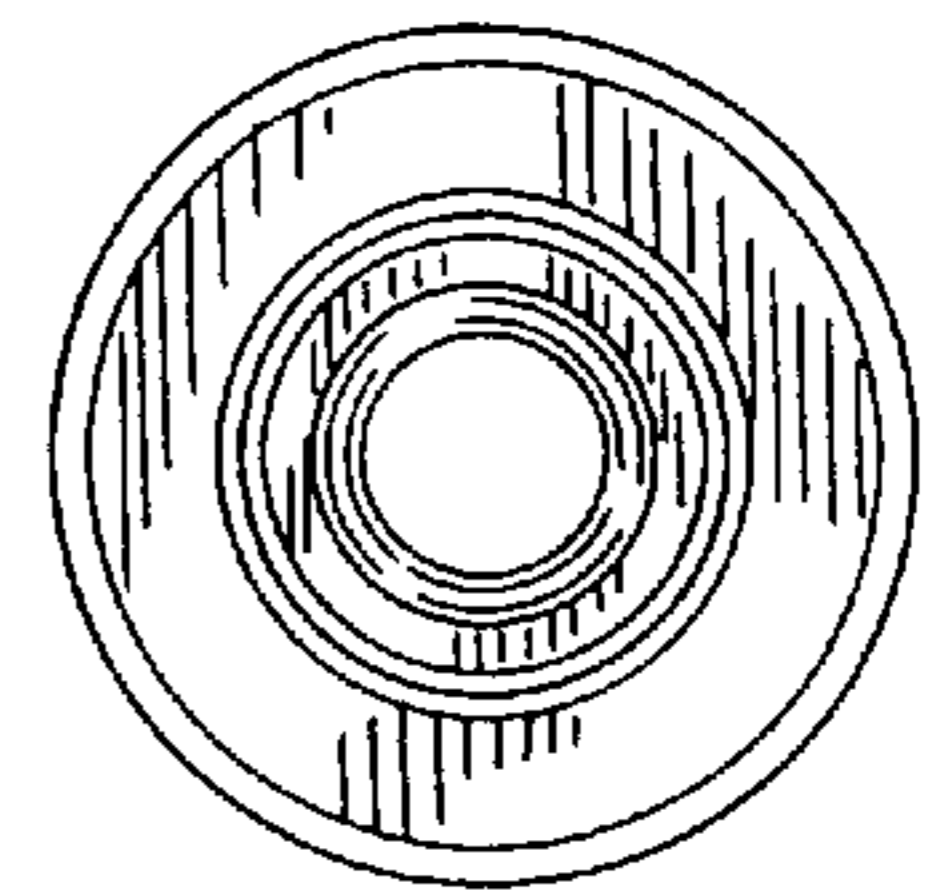

FIG. 9

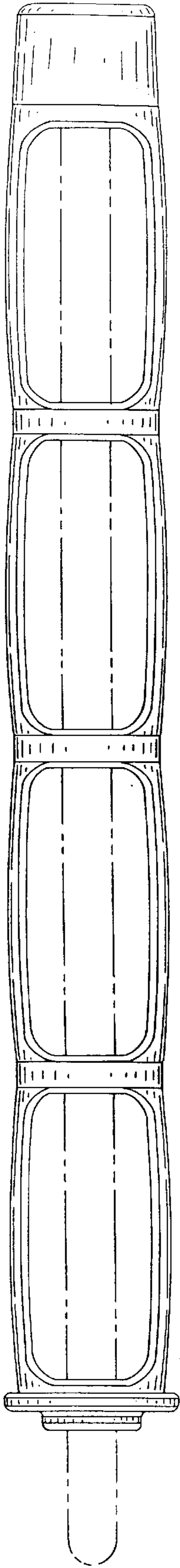

FIG. 10

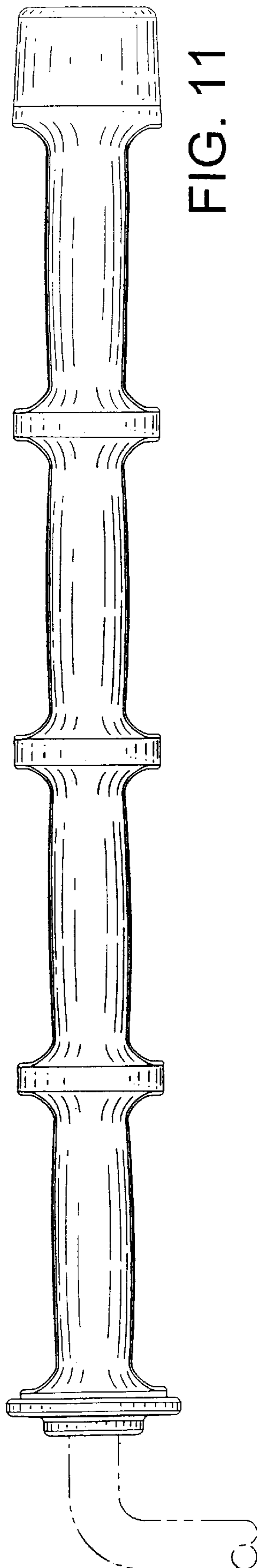

FIG. 11

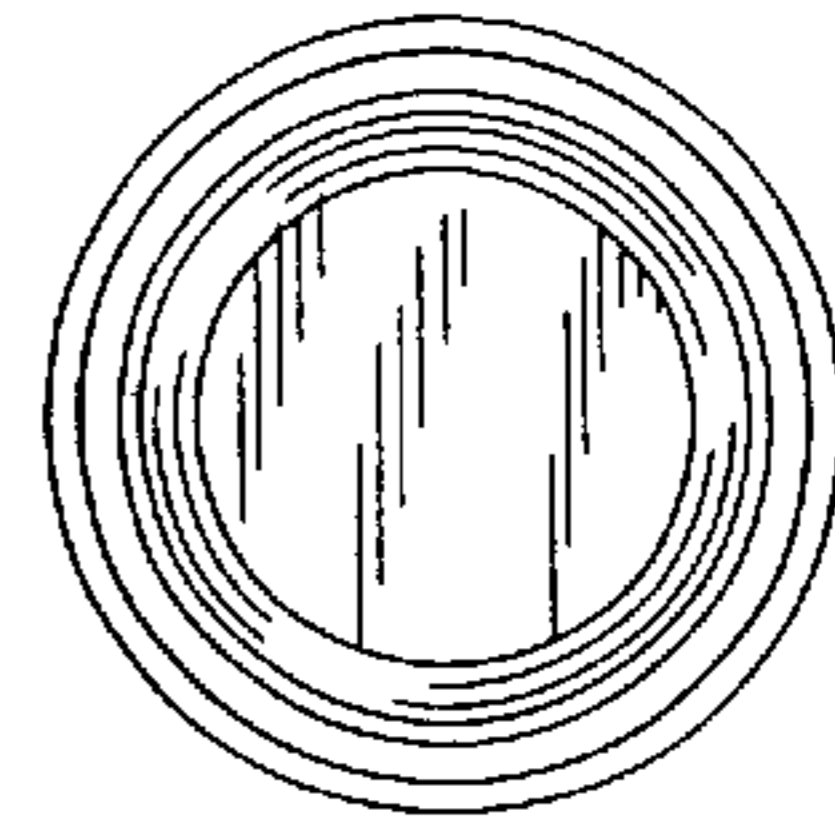

FIG. 12

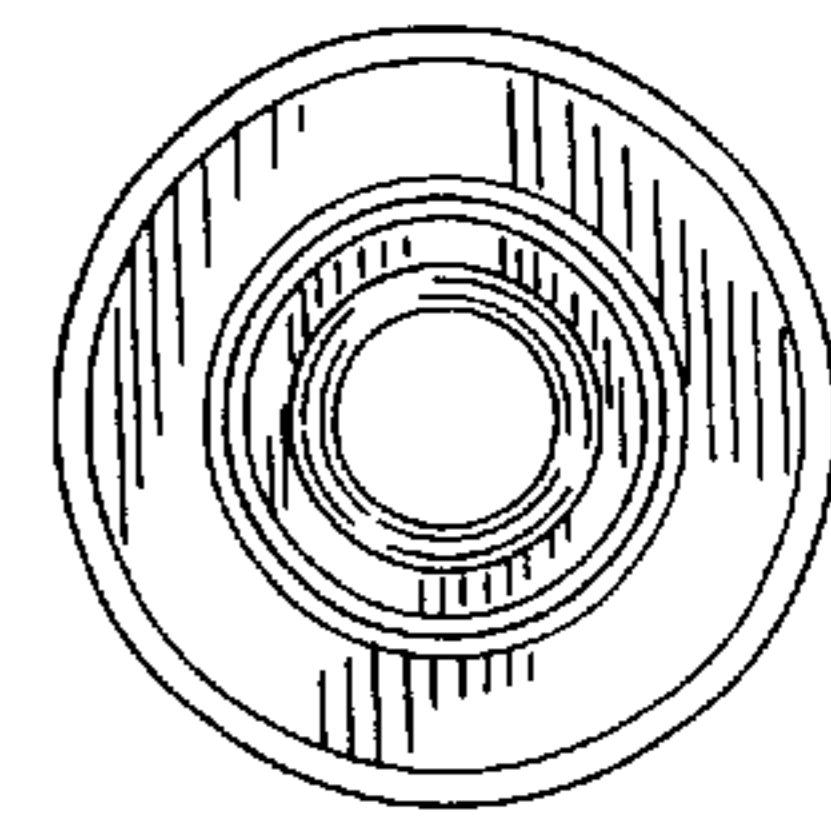

FIG. 13