



US00D473028S

(12) **United States Design Patent**
Hay et al.

(10) **Patent No.:** **US D473,028 S**

(45) **Date of Patent:** **** Apr. 8, 2003**

(54) **SQUEEGEE**

2,882,716 A * 4/1959 Anderson, Sr.
D222,703 S * 12/1971 Richardson D32/41
4,075,730 A * 2/1978 Siemund 15/245

(75) Inventors: **Donald Espie Hay**, Causeway Bay
(HK); **Christopher James Mccaughan**
Hay, Causeway Bay (HK)

* cited by examiner

(73) Assignee: **Hayco Manufacturing Limited**,
Causeway Bay (HK)

Primary Examiner—Alan P. Douglas
Assistant Examiner—Lavone D. Tabor
(74) *Attorney, Agent, or Firm*—Smith-Hill and Bedell

(**) Term: **14 Years**

(57) **CLAIM**

(21) Appl. No.: **29/162,424**

The ornamental design for “squeegee”, as shown and described.

(22) Filed: **Jun. 14, 2002**

DESCRIPTION

(51) **LOC (7) Cl.** **07-05**

(52) **U.S. Cl.** **D32/41**

(58) **Field of Search** D32/40–41, 46,
D32/49; 15/236.01, 236.02, 245, 245.1;
30/169

FIG. 1 is a perspective view of “squeegee” showing our new design;
FIG. 2 is a top view thereof;
FIG. 3 is a bottom view thereof;
FIG. 4 is a front view thereof;
FIG. 5 is rear view thereof;
FIG. 6 is side view thereof; and,
FIG. 7 is another side view thereof.

(56) **References Cited**

U.S. PATENT DOCUMENTS

1,706,053 A * 3/1929 Bussinger 15/245
1,828,139 A * 10/1931 Hawrylasz 15/245

1 Claim, 6 Drawing Sheets

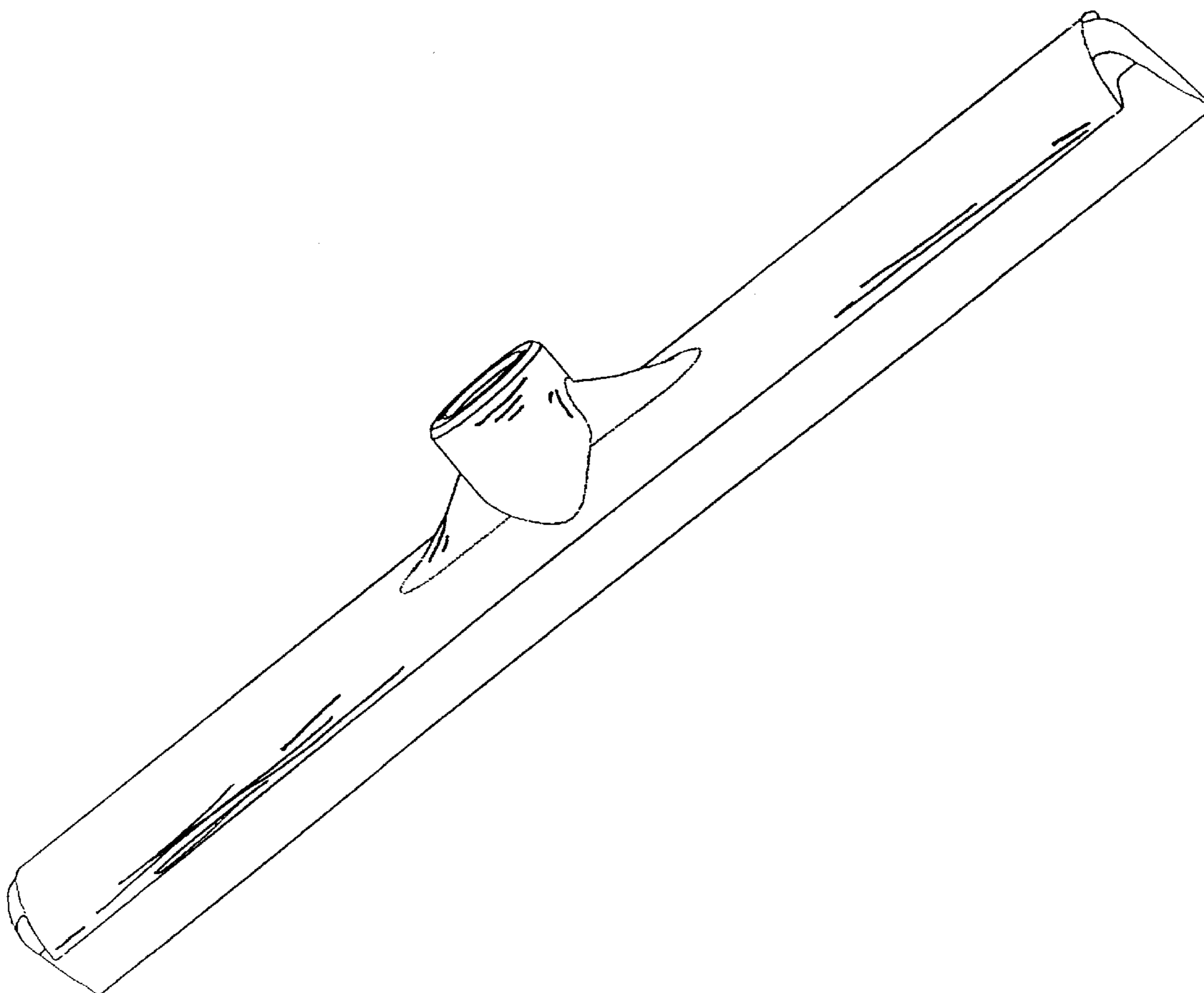

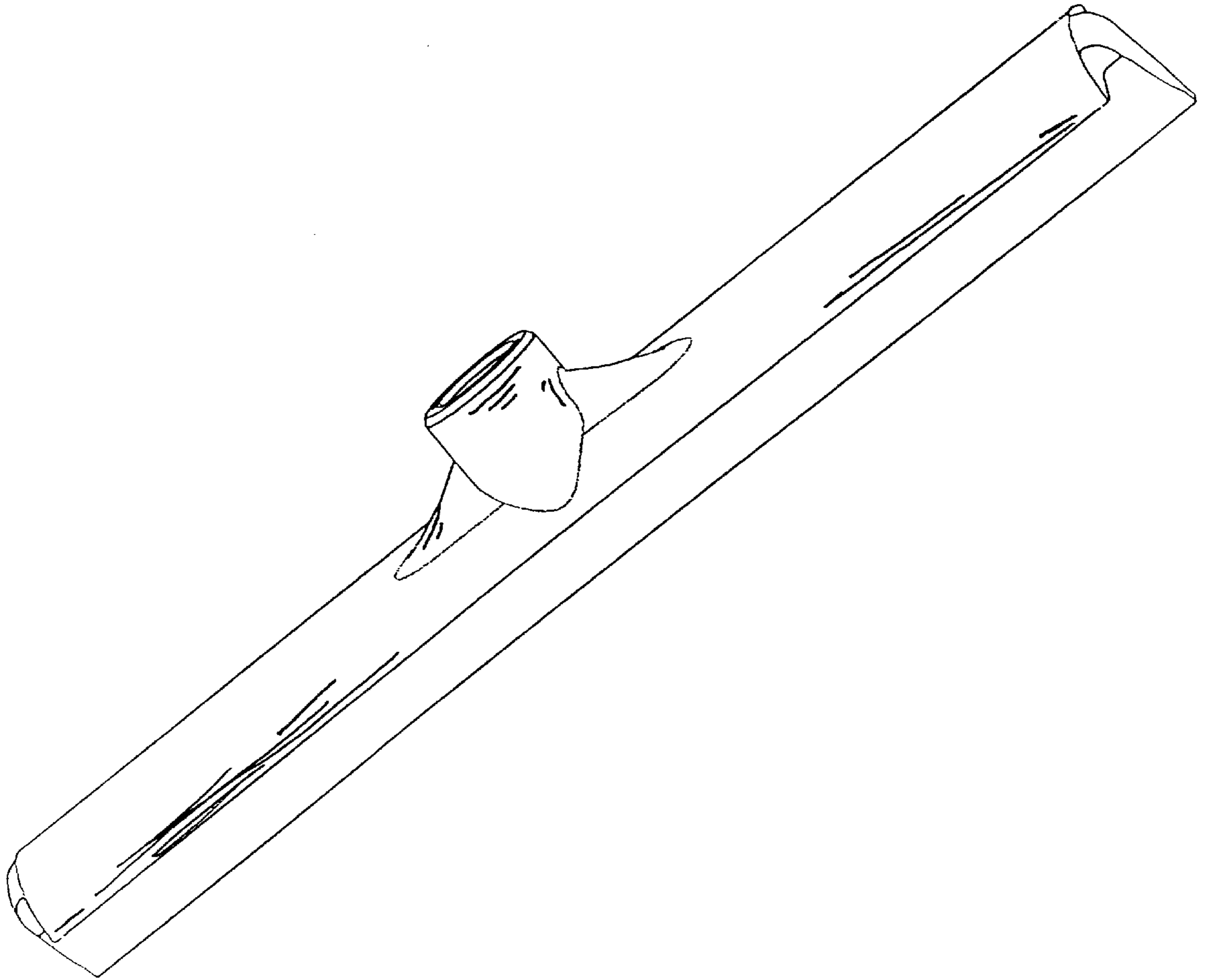

FIG. 1

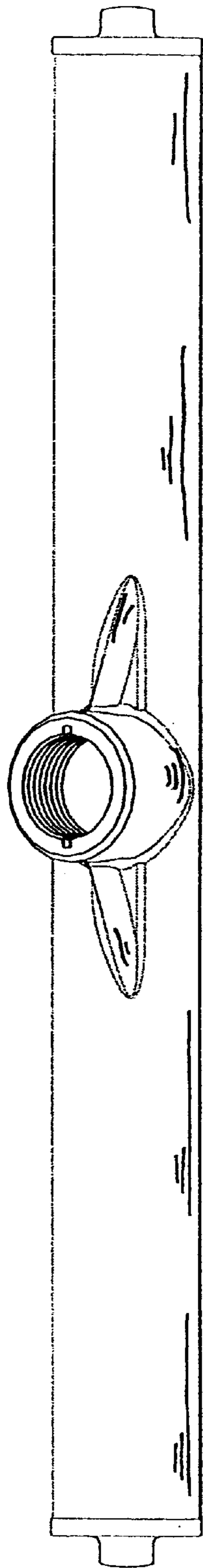

FIG. 2

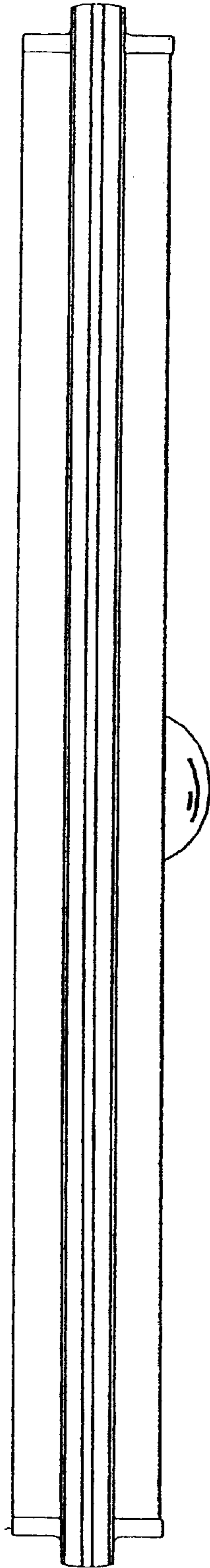

FIG. 3

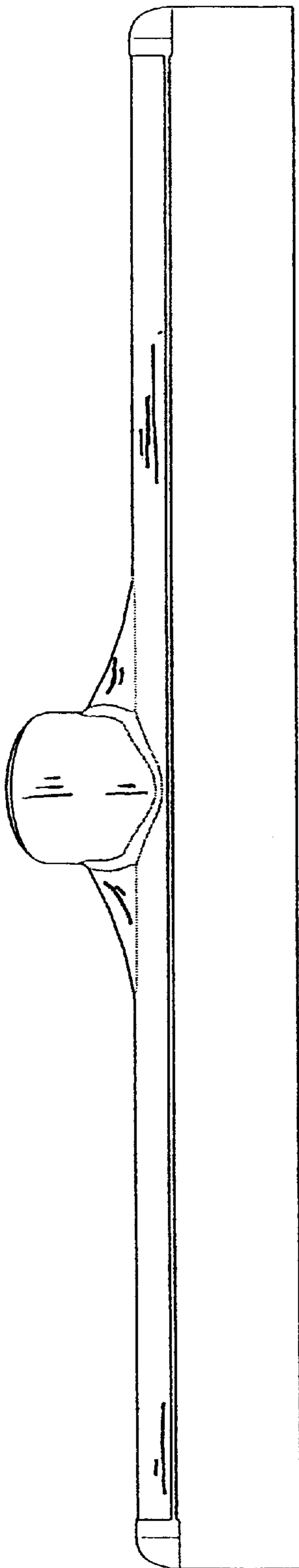

FIG. 4

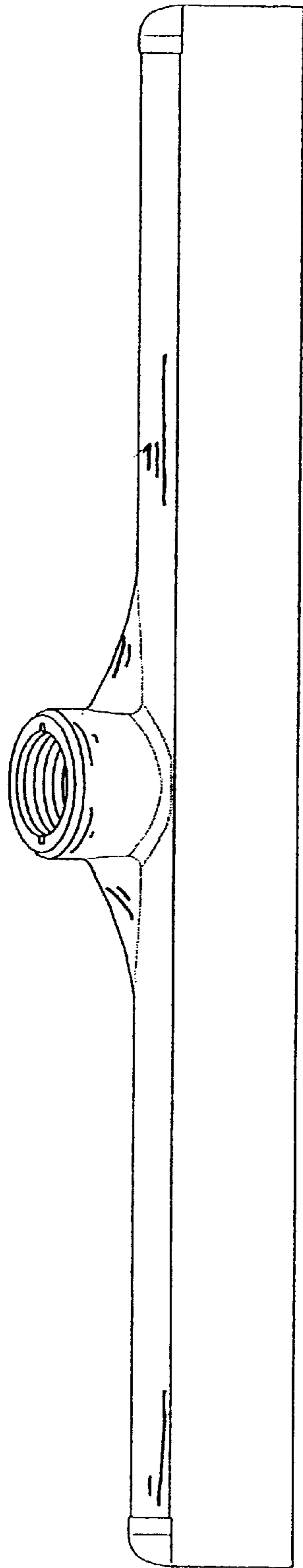

FIG. 5

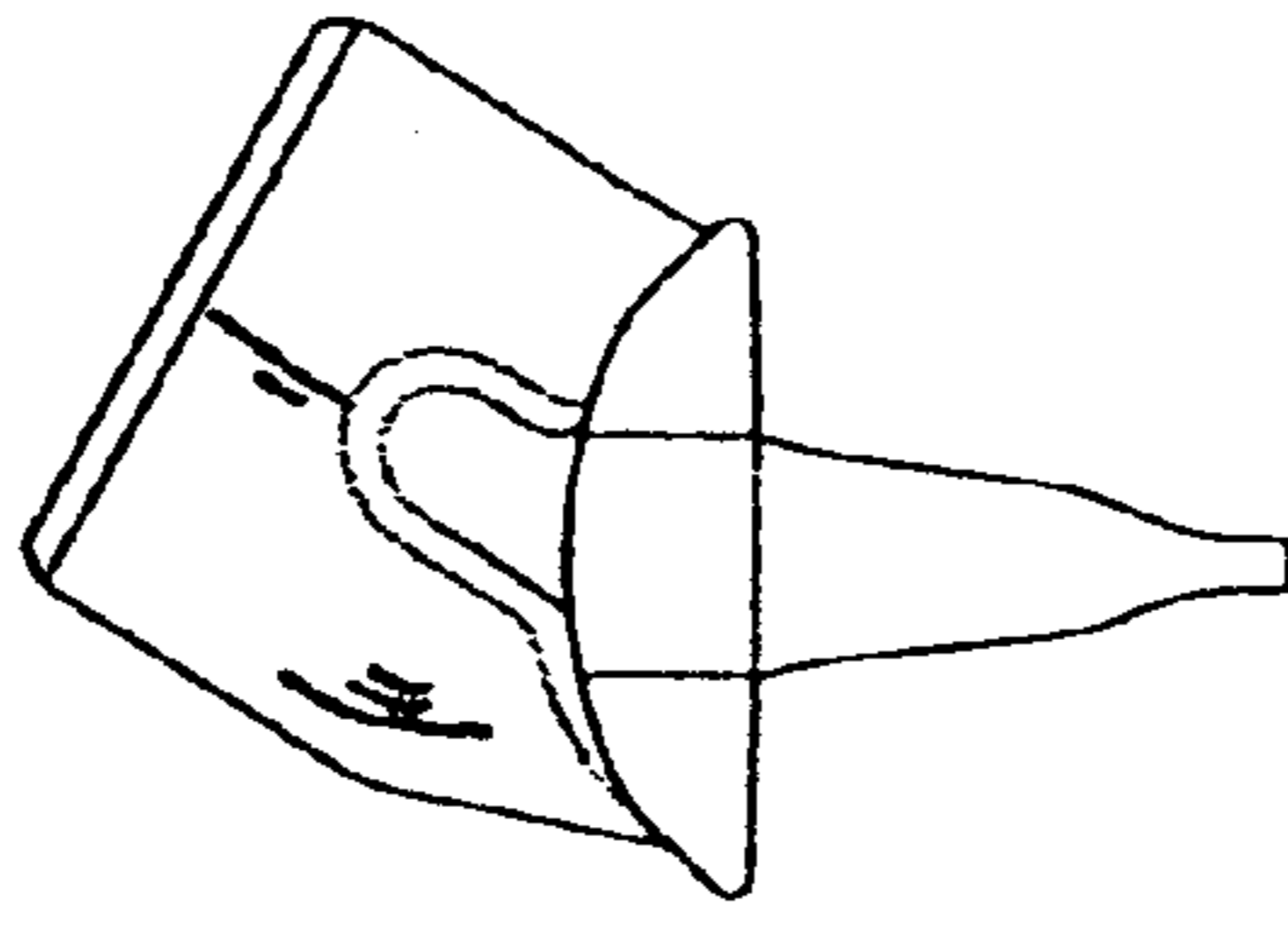

FIG. 6

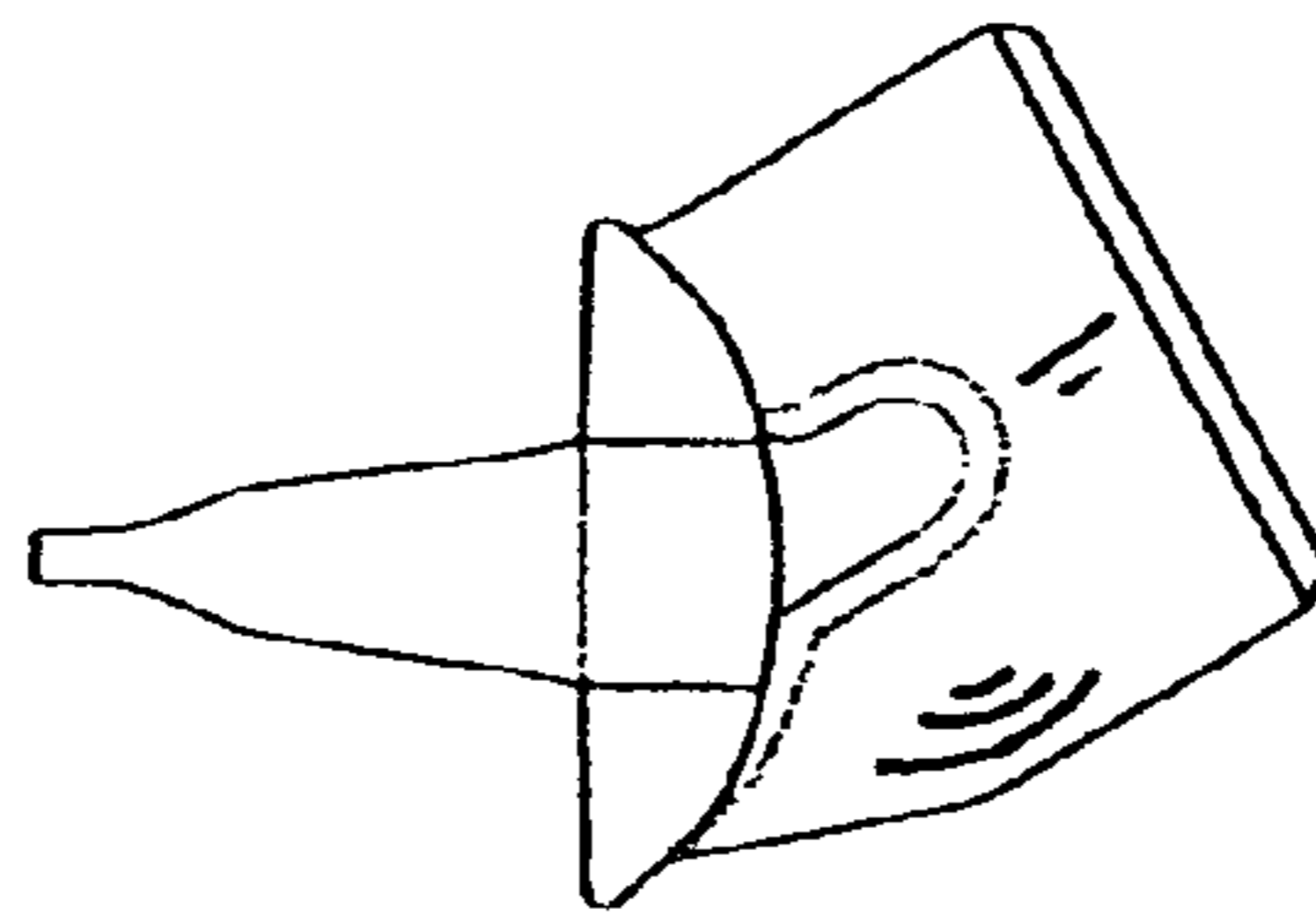

FIG. 7