



US00D472977S

(12) **United States Design Patent**  
**Griffiths**

(10) **Patent No.:** **US D472,977 S**

(45) **Date of Patent:** **\*\* Apr. 8, 2003**

(54) **SHUTTER**

(57) **CLAIM**

(76) **Inventor:** **Robert Phillip Griffiths**, 589 Gardners Road, Mascot NSW 2020 (AU)

The ornamental design for shutter, as shown and described.

(\*\*) **Term:** **14 Years**

**DESCRIPTION**

(21) **Appl. No.:** **29/161,041**

FIG. 1 is a front elevational view in accordance with my new design, a rear elevational view being identical;

(22) **Filed:** **May 20, 2002**

FIG. 2 is a greatly enlarged cross-sectional view of a portion of FIG. 1 taken along line 2—2 of FIG. 1;

(51) **LOC (7) Cl.** ..... **25-02**

FIG. 3 is a greatly enlarged cross-sectional view of a portion of FIG. 1 taken along line 3—3 of FIG. 1;

(52) **U.S. Cl.** ..... **D25/47**

FIG. 4 is a top perspective view of the frame of the shutter shown in FIG. 1;

(58) **Field of Search** ..... **D25/49; 52/73**

(56) **References Cited**

FIG. 5 is an enlarged exploded partial perspective view of a corner assembly of the shutter shown in FIG. 1; and,

**U.S. PATENT DOCUMENTS**

3,455,079 A \* 7/1969 Frederick ..... 52/473  
D246,116 S \* 10/1977 Beirie ..... D25/49

FIG. 6 is a greatly enlarged exploded partial perspective view of the corner assembly shown in FIG. 5.

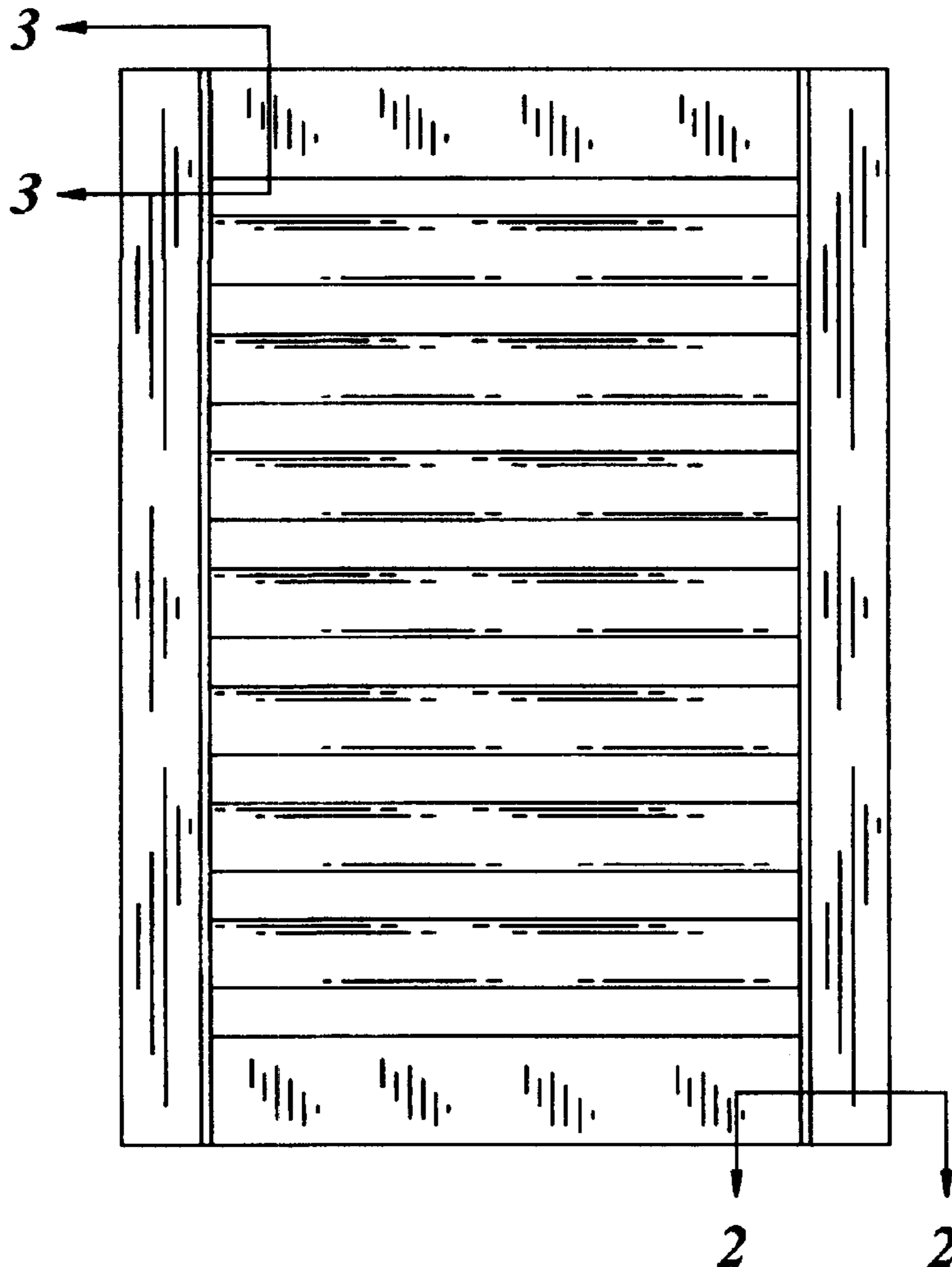
\* cited by examiner

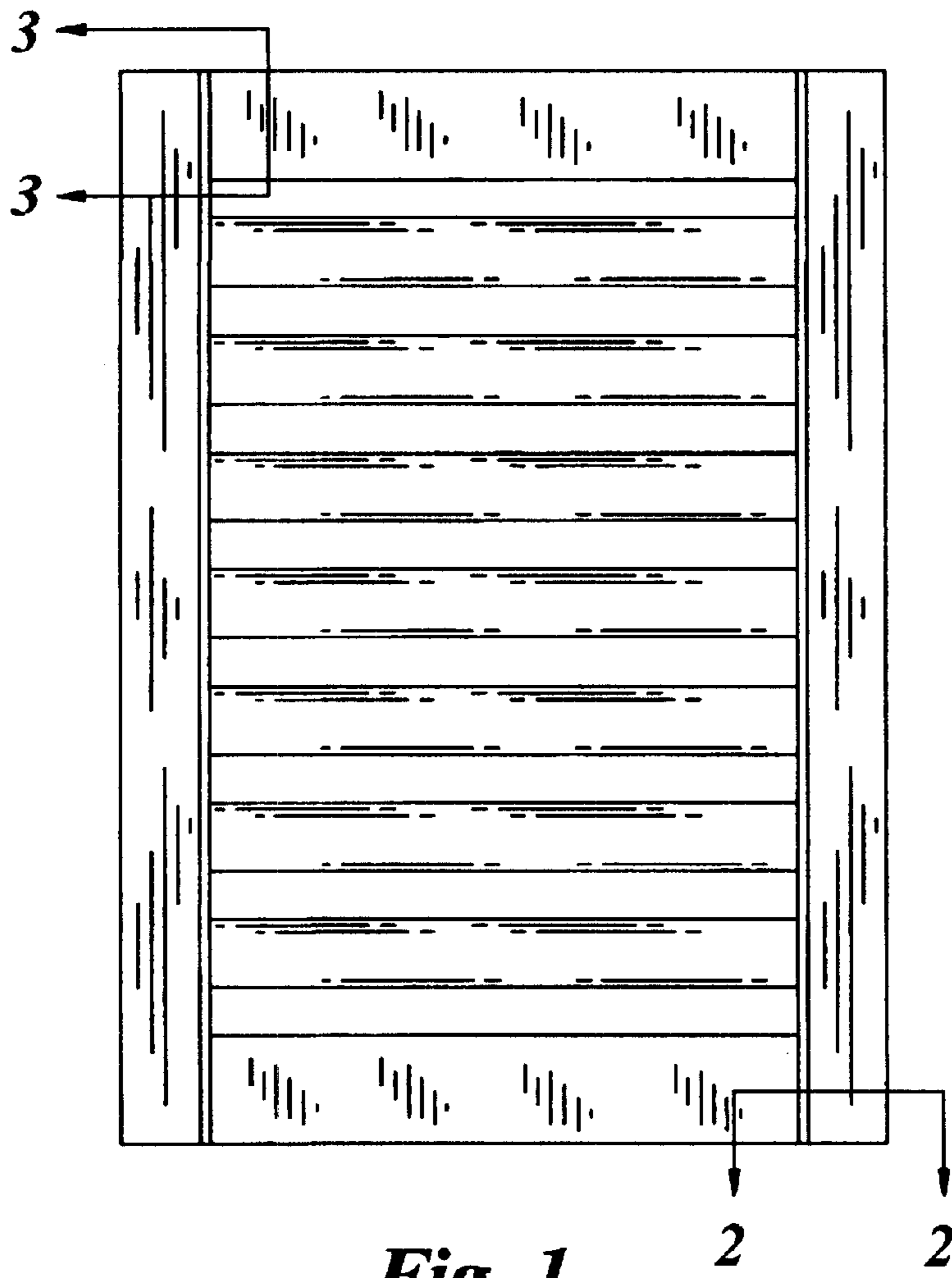
The broken lines are for illustrative purposes only and form no part of the claimed design.

*Primary Examiner*—Doris Clark

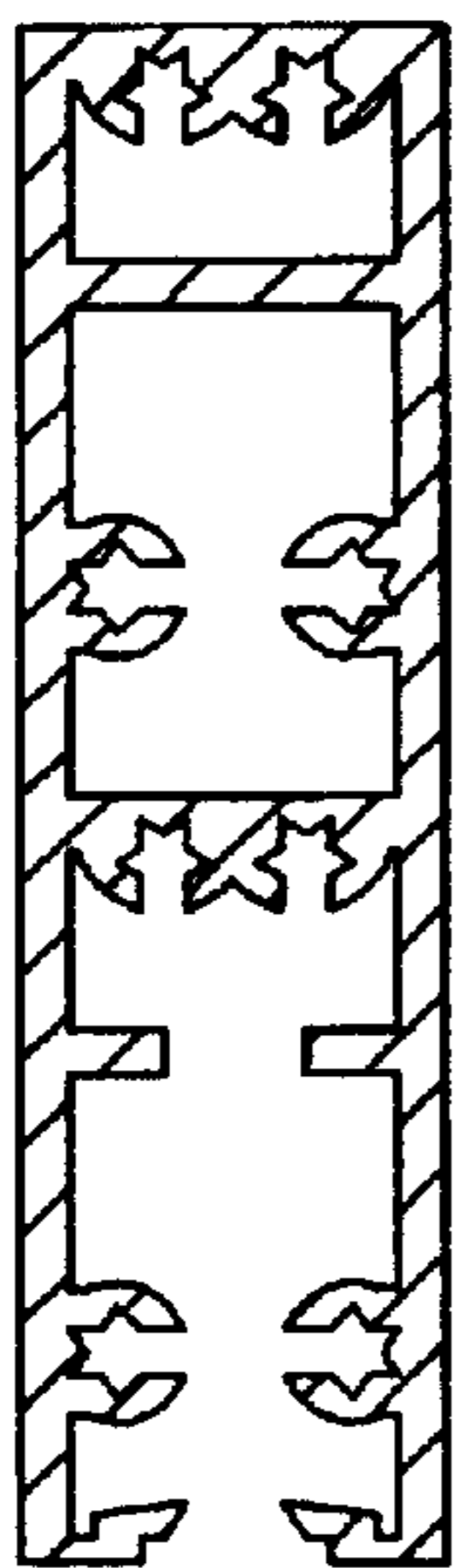
(74) *Attorney, Agent, or Firm*—Akin Gump Strauss Haver & Feld, L.L.P.

**1 Claim, 4 Drawing Sheets**

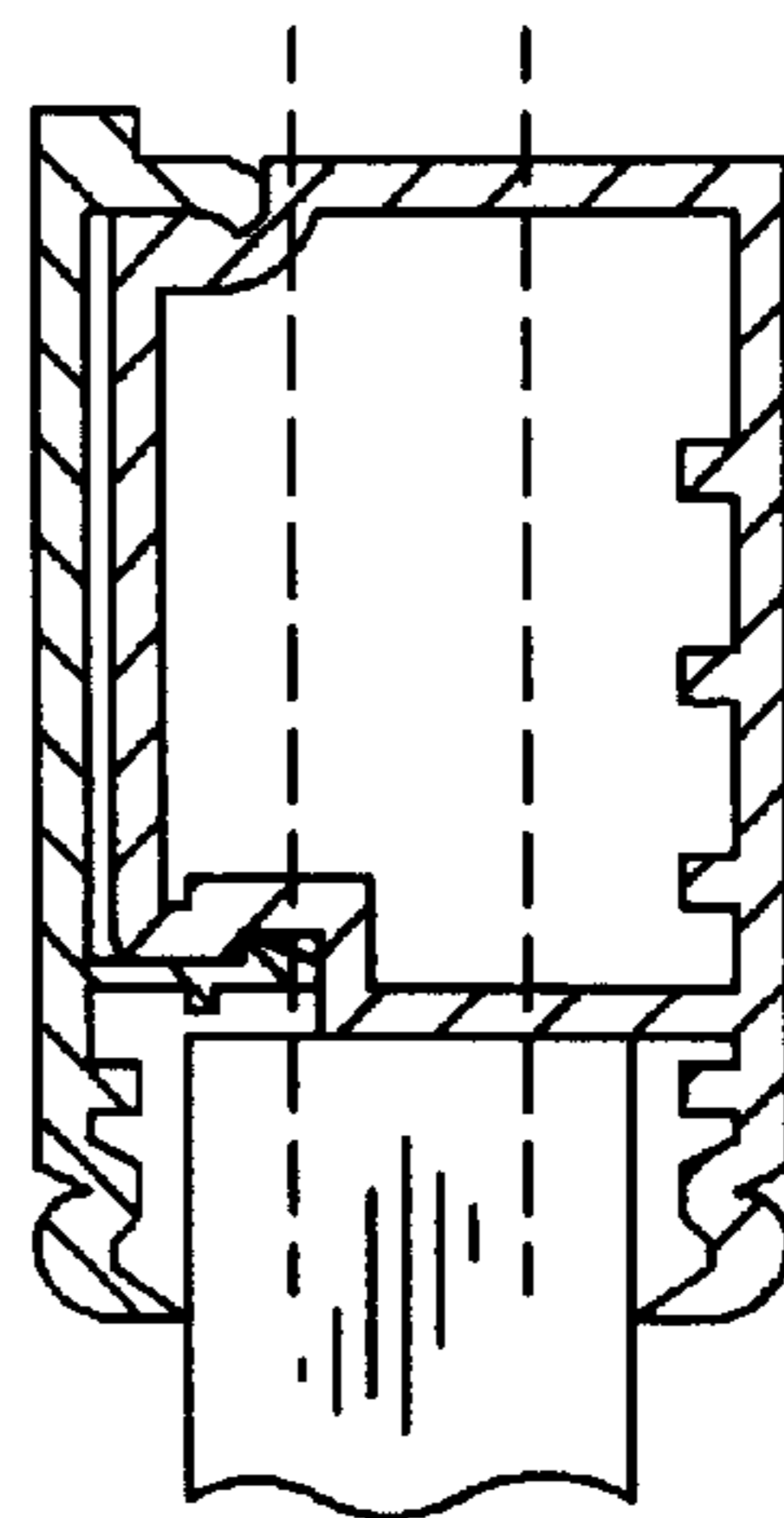




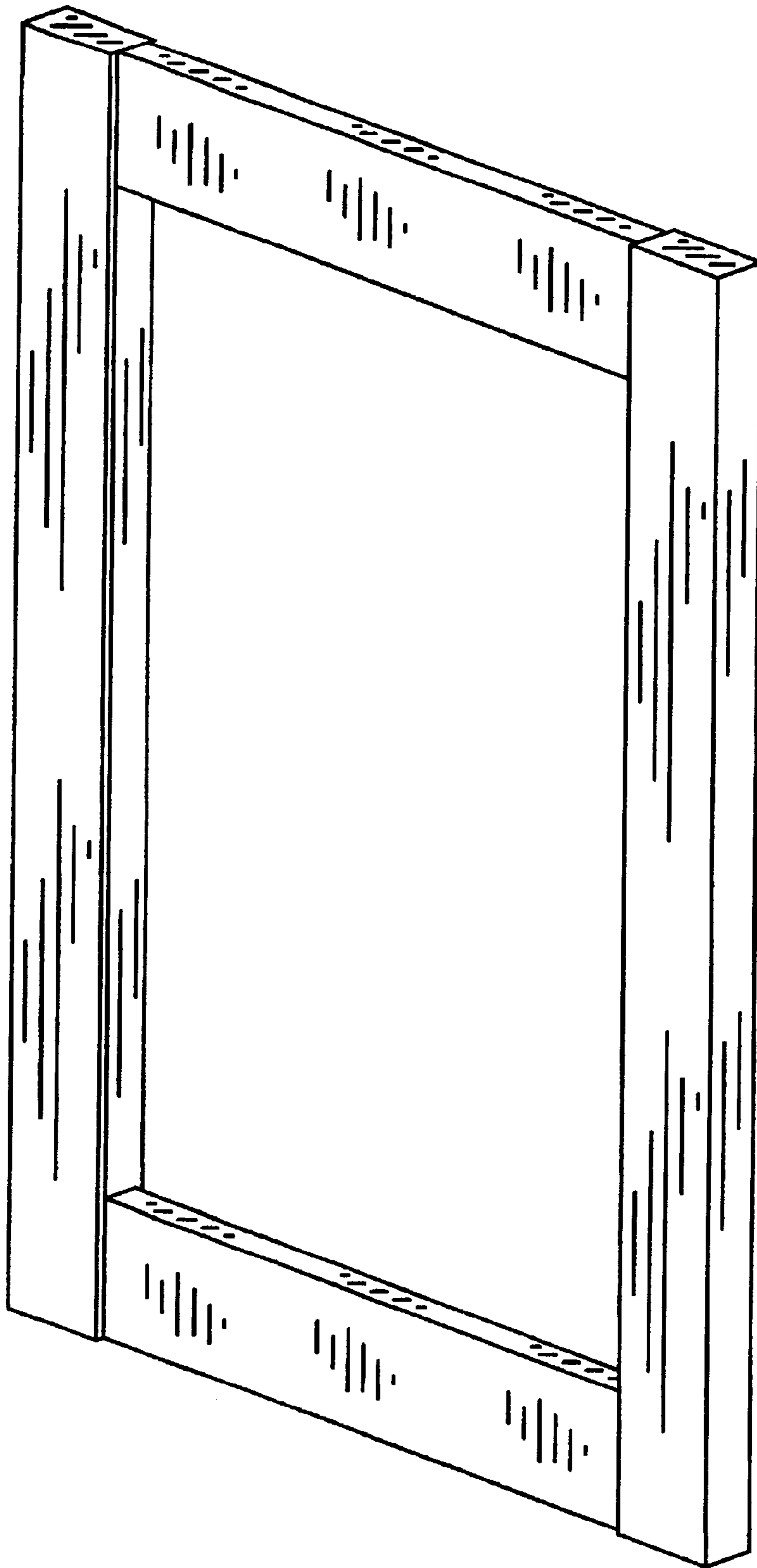
*Fig. 1*



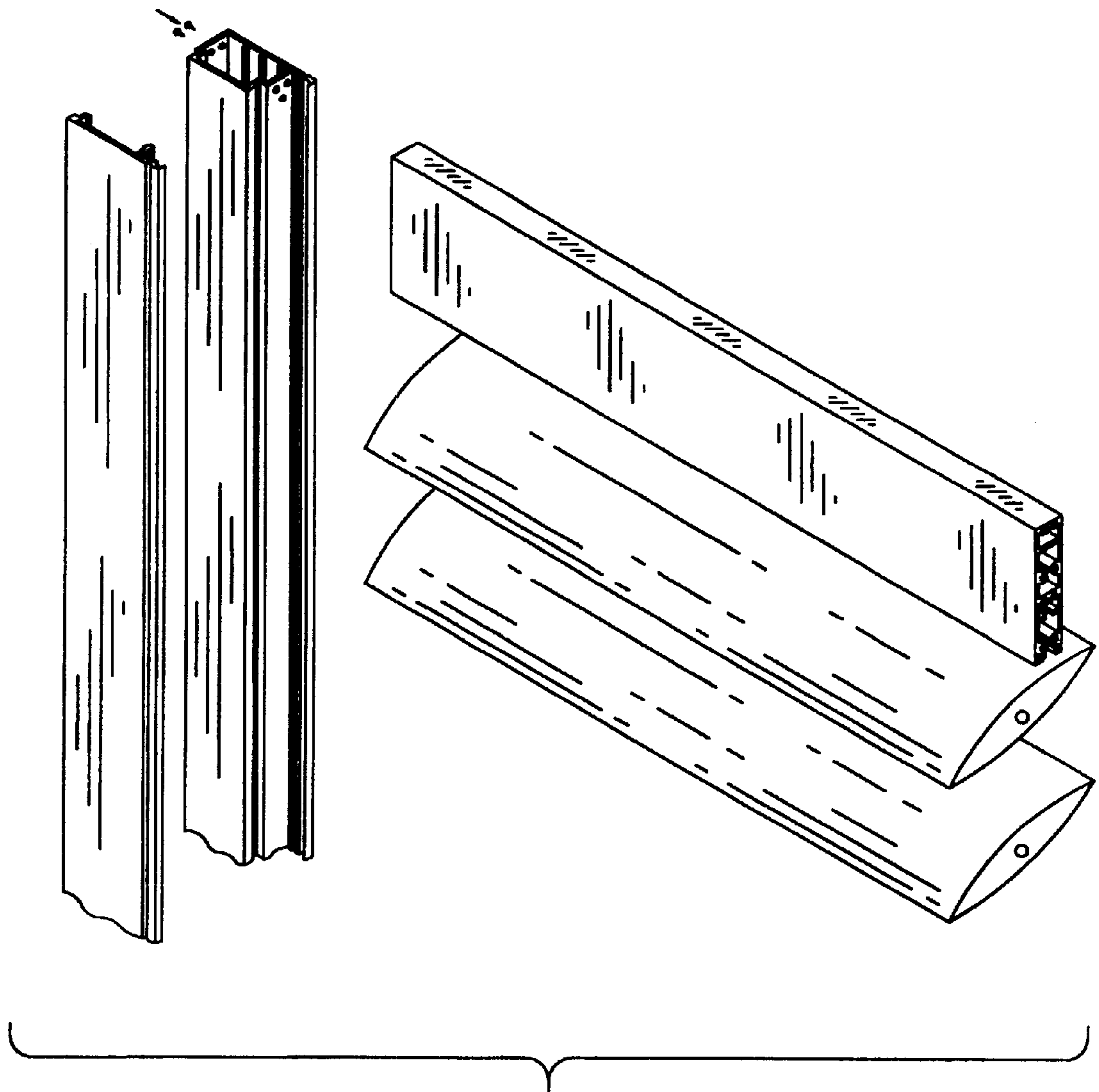
*Fig. 3*



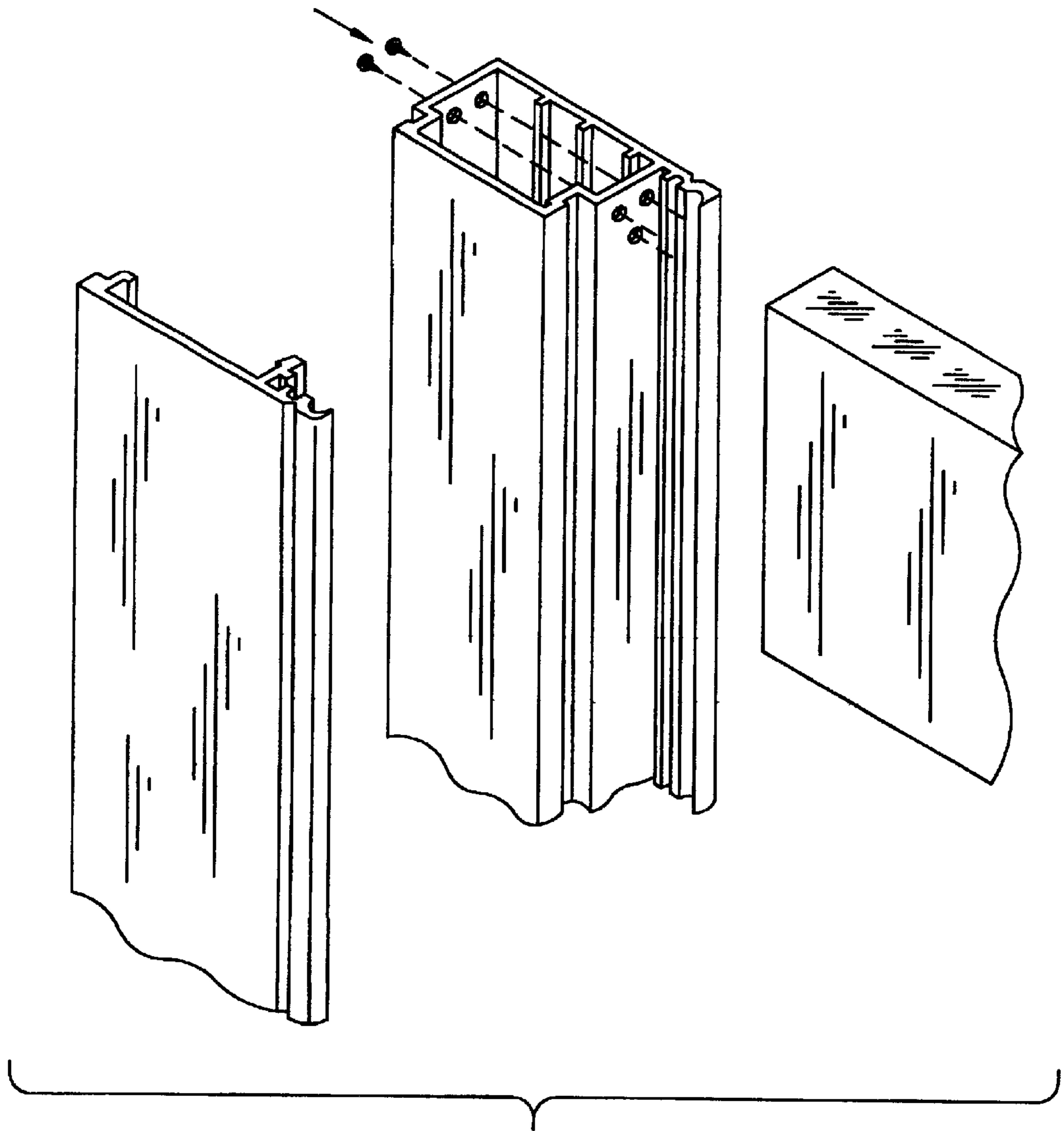
*Fig. 2*



*Fig. 4*



*Fig. 5*



*Fig. 6*