



US00D472939S

(12) **United States Design Patent**
Philpott

(10) **Patent No.:** **US D472,939 S**

(45) **Date of Patent:** **** Apr. 8, 2003**

(54) **GAMING MACHINE BASE CABINET**

(76) **Inventor:** **Darryl Philpott**, 181 Boundary Road,
Cootamundra, NSW 2590 (AU)

(**) **Term:** **14 Years**

(21) **Appl. No.:** **29/151,614**

(22) **Filed:** **Dec. 3, 2001**

(51) **LOC (7) Cl.** **21-01**

(52) **U.S. Cl.** **D21/385; D21/369**

(58) **Field of Search** D21/369, 370,
D21/374, 375; 273/309; 463/17, 20, 46,
47

(56) **References Cited**

U.S. PATENT DOCUMENTS

D207,226 S	*	3/1967	Fries	D6/446
D354,637 S	*	1/1995	Jarrett	D6/432
D399,889 S	*	10/1998	Ward	D21/385
5,826,882 A	*	10/1998	Ward	273/309
6,042,115 A	*	3/2000	Ward	273/309

* cited by examiner

Primary Examiner—Sandra L. Morris
(74) *Attorney, Agent, or Firm*—Edwin D. Schindler

(57) **CLAIM**

The ornamental design for a gaming machine base cabinet, as shown and described.

DESCRIPTION

FIG. 1 is a front perspective view of a gaming machine base cabinet showing the present design;
FIG. 2 is a side perspective view of the gaming machine base cabinet of FIG. 1;
FIG. 3 is a rear perspective view of the gaming machine base cabinet of FIG. 1;
FIG. 4 is a perspective view of the gaming machine base cabinet of FIG. 1;
FIG. 5 is a plan elevational view of the gaming machine base cabinet of FIG. 1;
FIG. 6 is a further front elevational view of the gaming machine base cabinet of FIG. 1; and,
FIG. 7 is a further rear elevational view of the gaming machine base cabinet of FIG. 1.

1 Claim, 4 Drawing Sheets

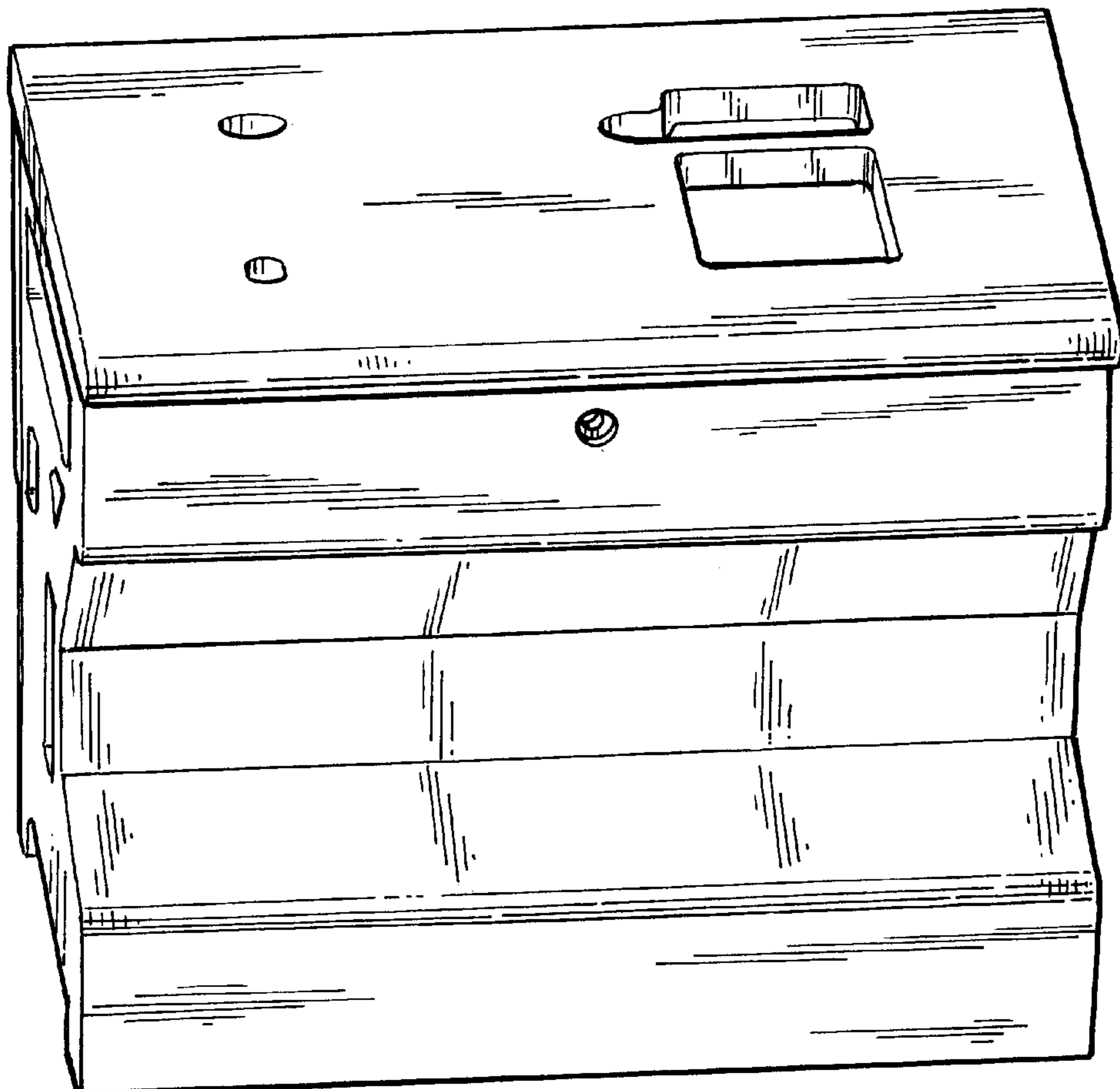

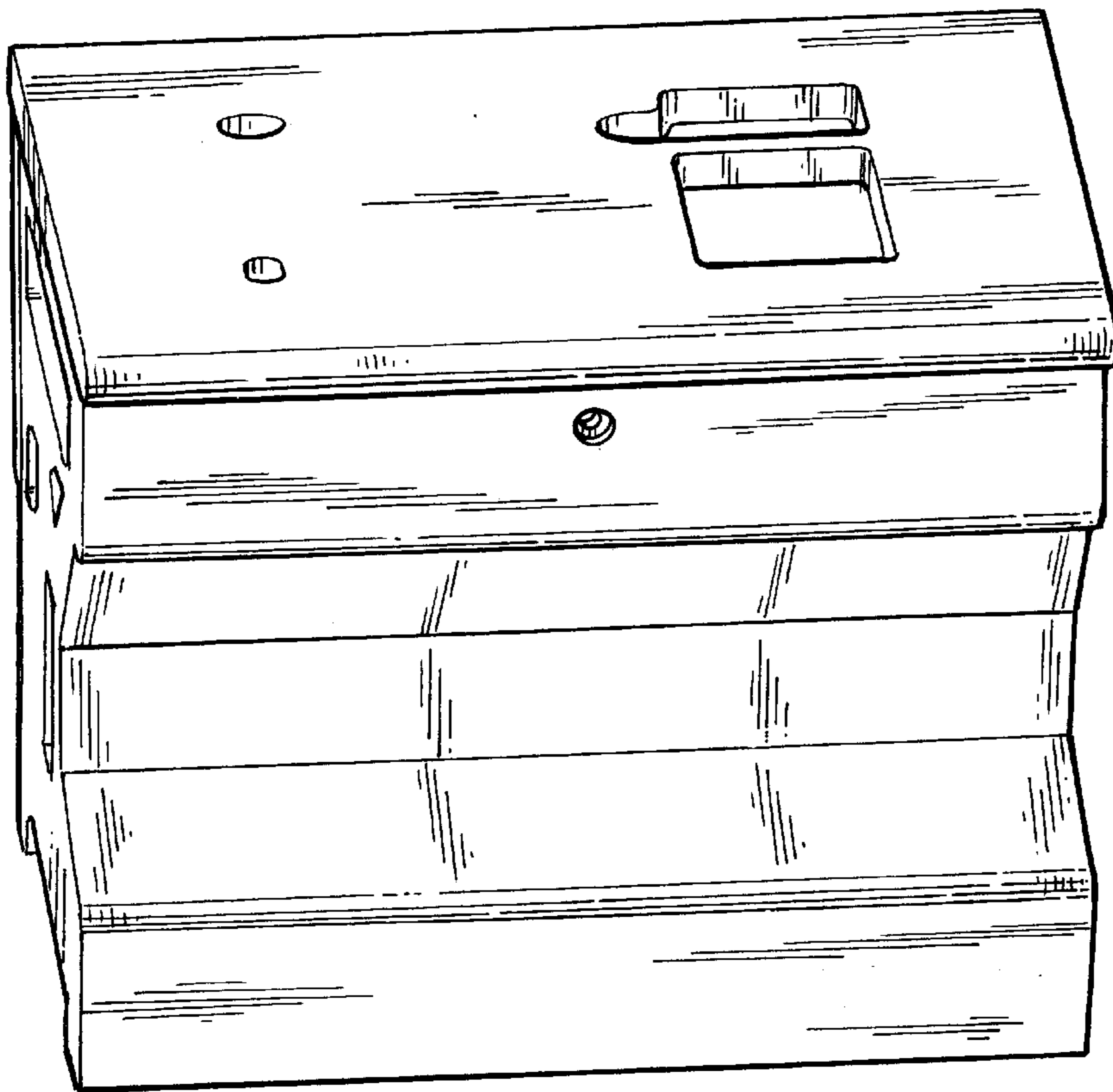

FIG. 1.

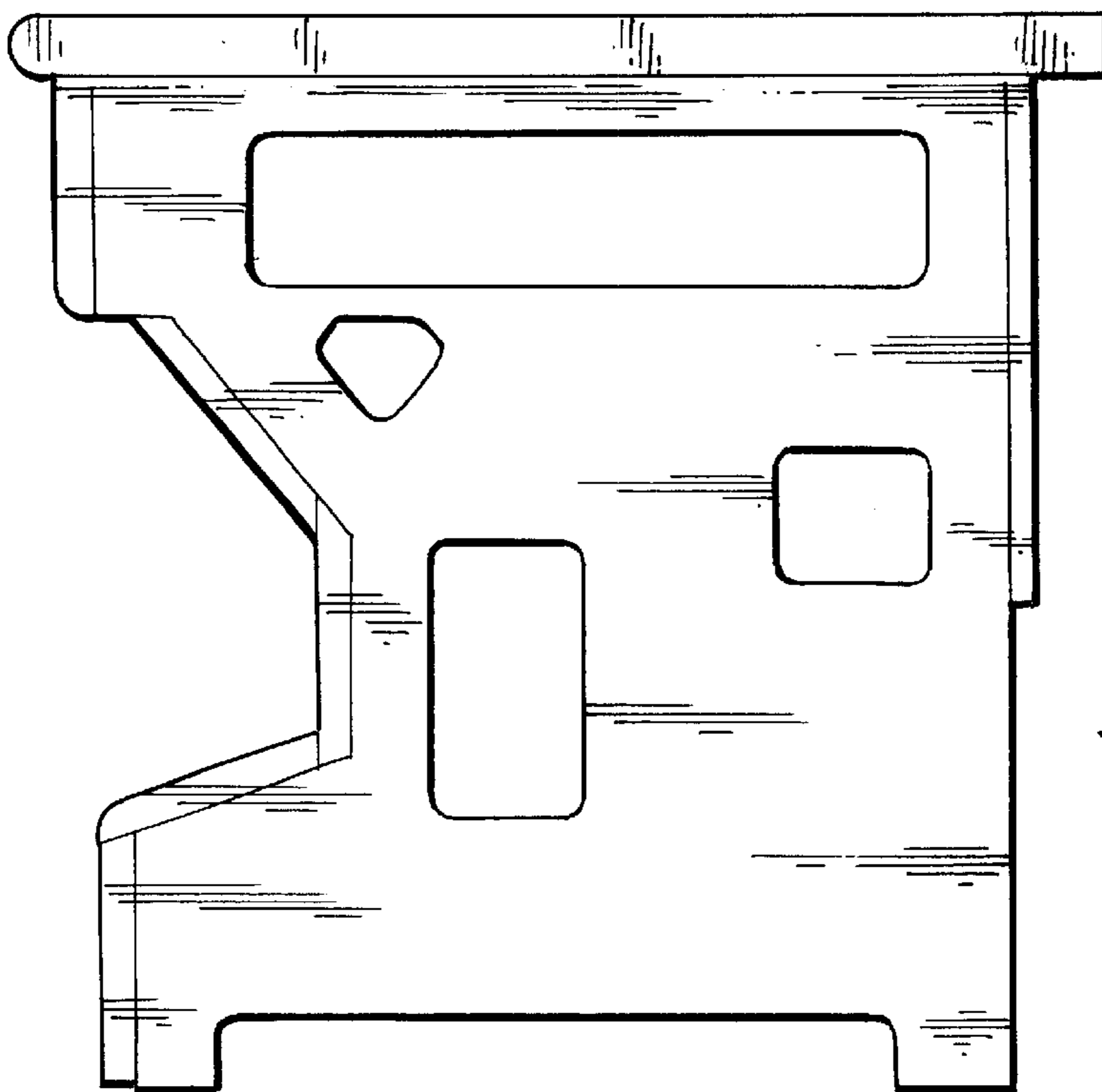

FIG. 2.

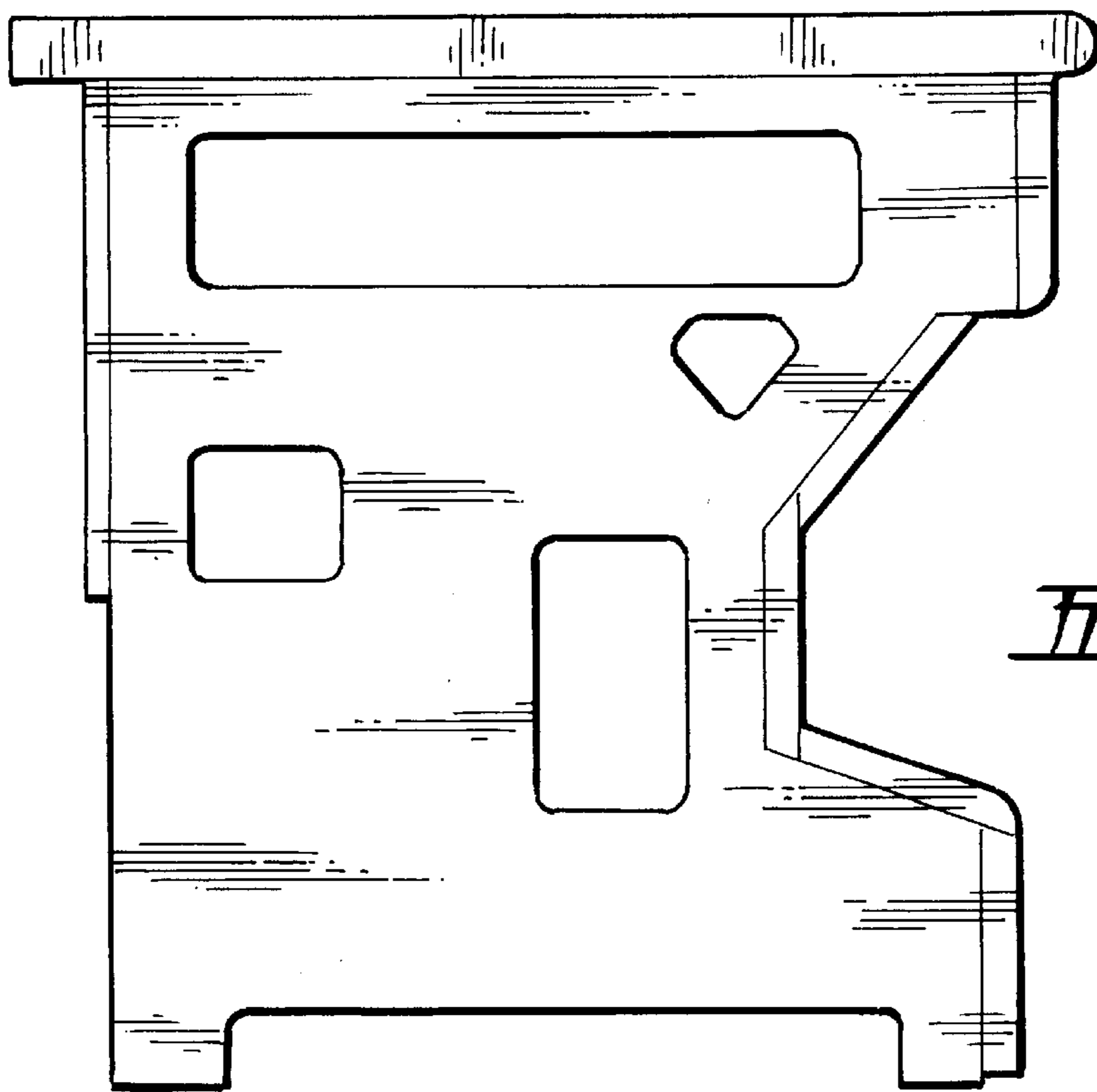

FIG. 3.

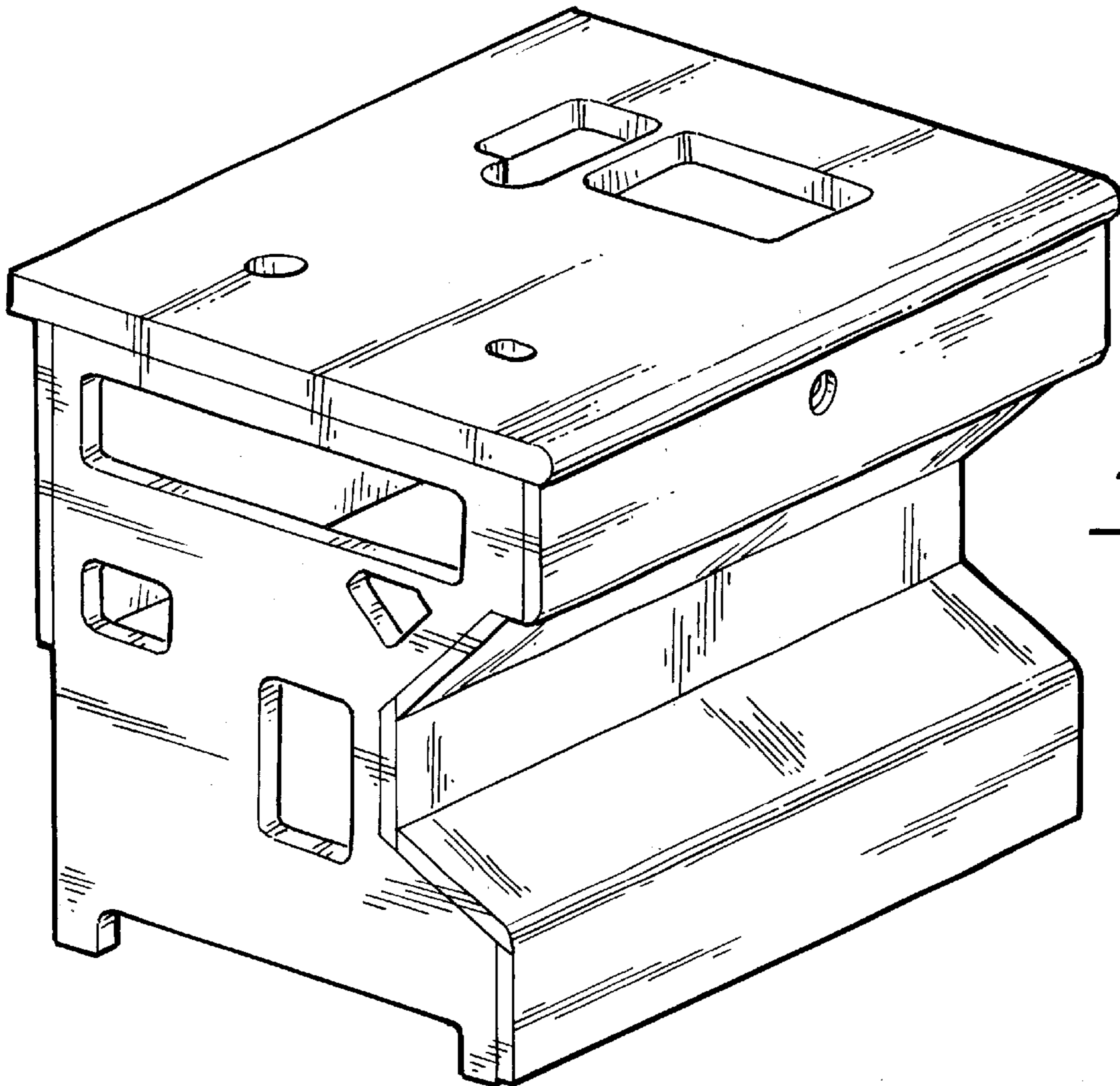

FIG. 4.

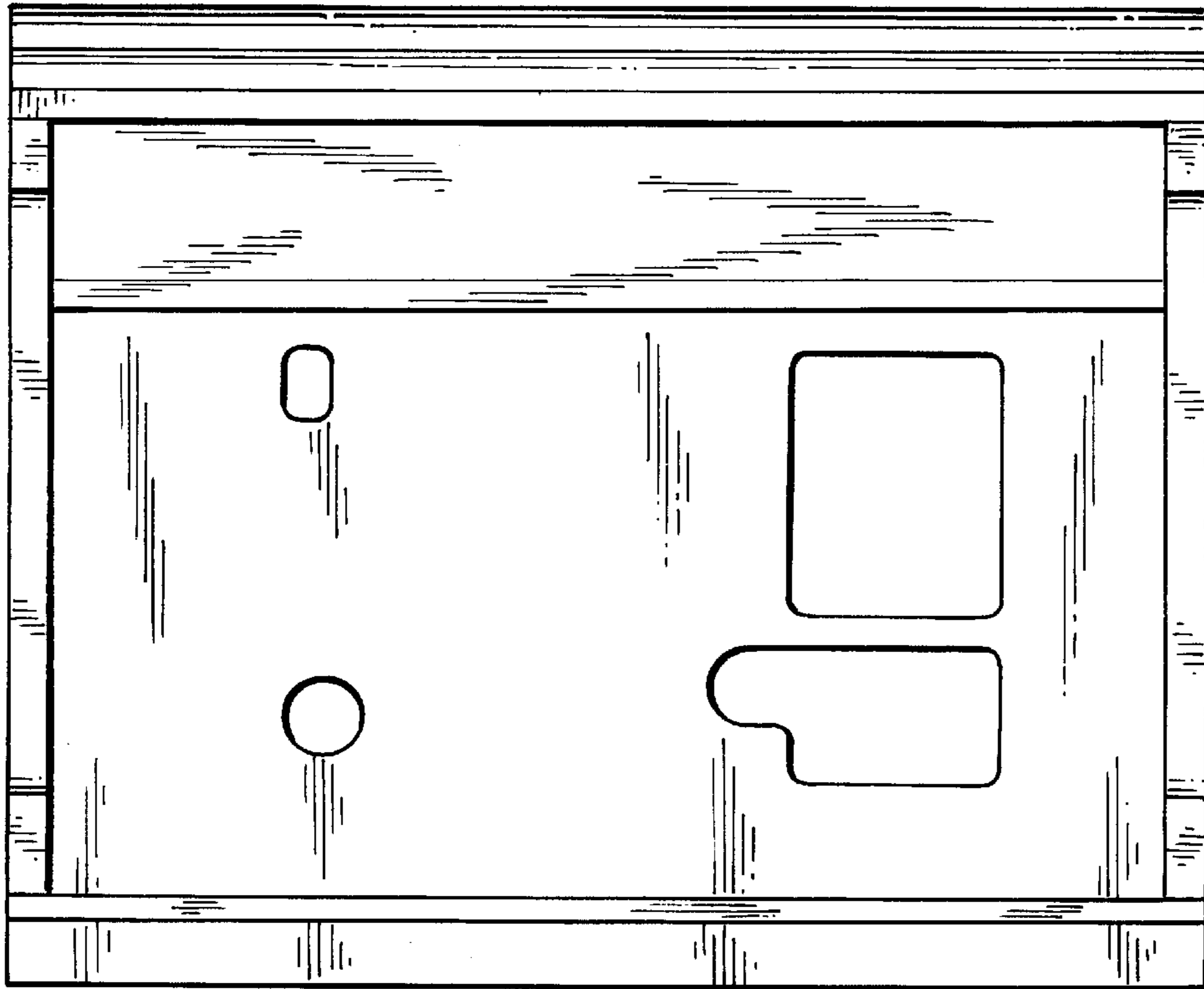

FIG. 5.

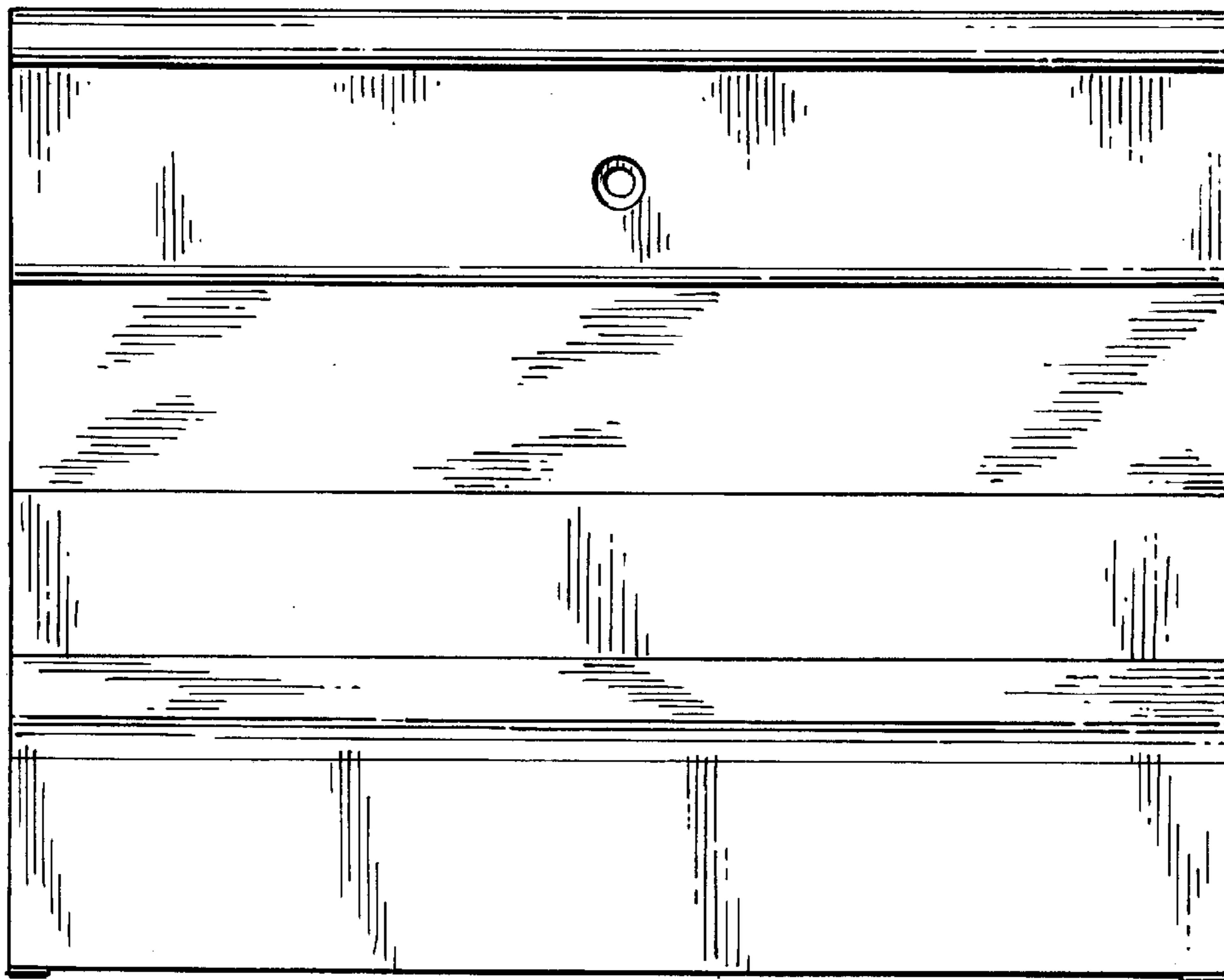

FIG. 6.

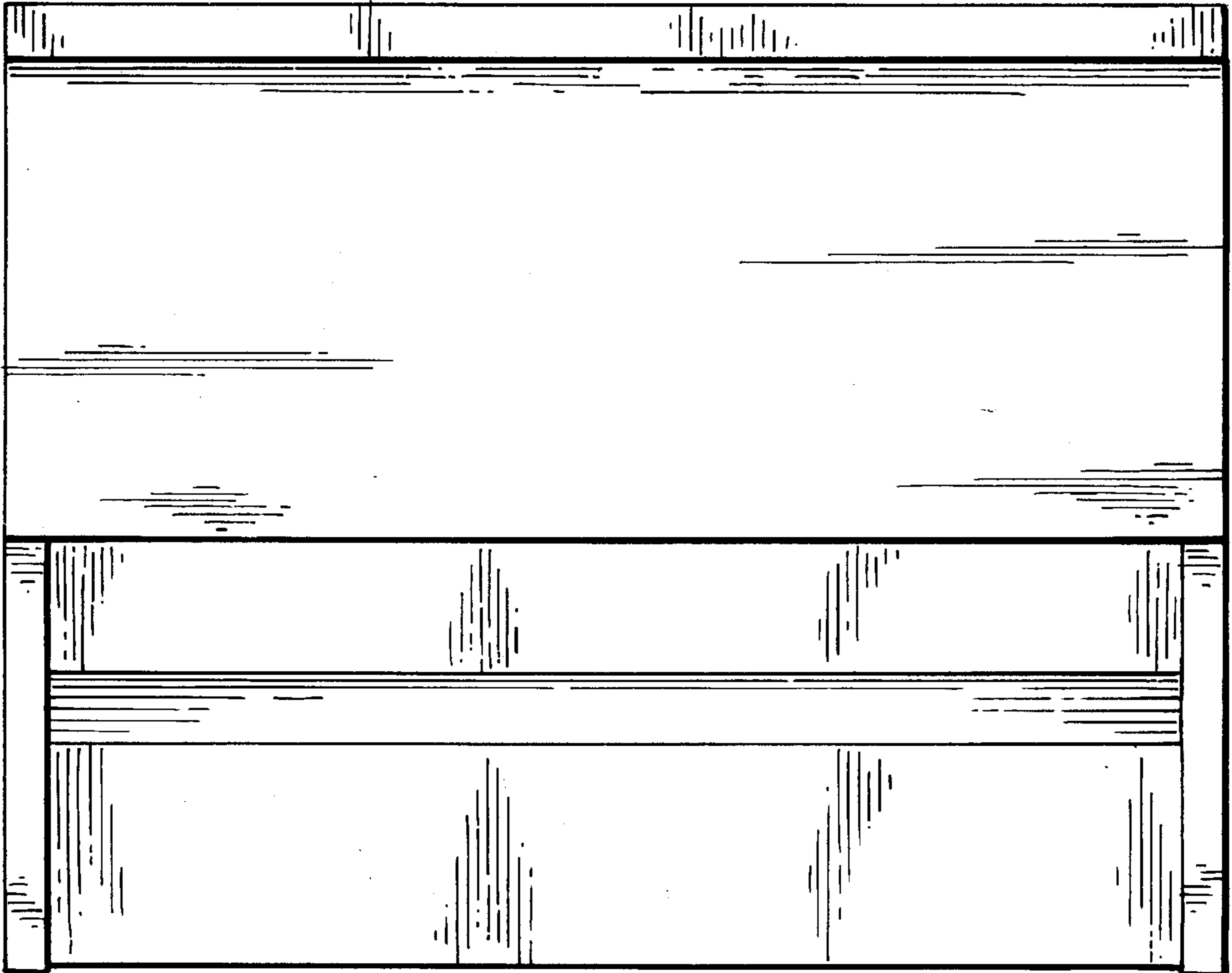

FIG. 7.