



US00D472795S

(12) **United States Design Patent**
Saxby

(10) **Patent No.:** **US D472,795 S**

(45) **Date of Patent:** **** Apr. 8, 2003**

(54) **POSITIONING DEVICE**

(76) **Inventor:** **George Saxby**, 61 Lorimer Crescent,
Regina, SK (CA), S4R 3Y3

(**) **Term:** **14 Years**

(21) **Appl. No.:** **29/163,181**

(22) **Filed:** **Jun. 28, 2002**

(51) **LOC (7) Cl.** **08-05**

(52) **U.S. Cl.** **D8/373; D8/367**

(58) **Field of Search** D8/373, 367, 368;
211/60.1, 106.01, 13.1, 65-66, 113, 123,
118, 31-32, 85.3; 160/348, 349.2; 248/497,
314, 489, 301-304, 216.1, 467, 339, 251,
231.91, 205.3, 306, 317

(56) **References Cited**

U.S. PATENT DOCUMENTS

2,232,094 A * 2/1941 Canfield 248/339
2,693,864 A * 11/1954 Ferro 96/117.5
2,788,438 A * 4/1957 Lieuwen 362/344

D328,562 S * 8/1992 Lin D8/373
5,137,158 A * 8/1992 Brockway 211/106.01
6,302,281 B1 * 10/2001 Wang 211/118

* cited by examiner

Primary Examiner—Pamela Burgess

(57) **CLAIM**

The ornamental design for a positioning device, as shown and described.

DESCRIPTION

FIG. 1 is a front elevational view of a positioning device showing my new design;
FIG. 2 is a rear elevational view thereof;
FIG. 3 is a side view, taken from the left side of FIG. 1;
FIG. 4 is a side view, taken from the right side of FIG.1;
FIG. 5 is a top plan view thereof;
FIG. 6 is a bottom plan view thereof; and,
FIG. 7 is a front elevational view showing the parts of my design disassembled.

1 Claim, 2 Drawing Sheets

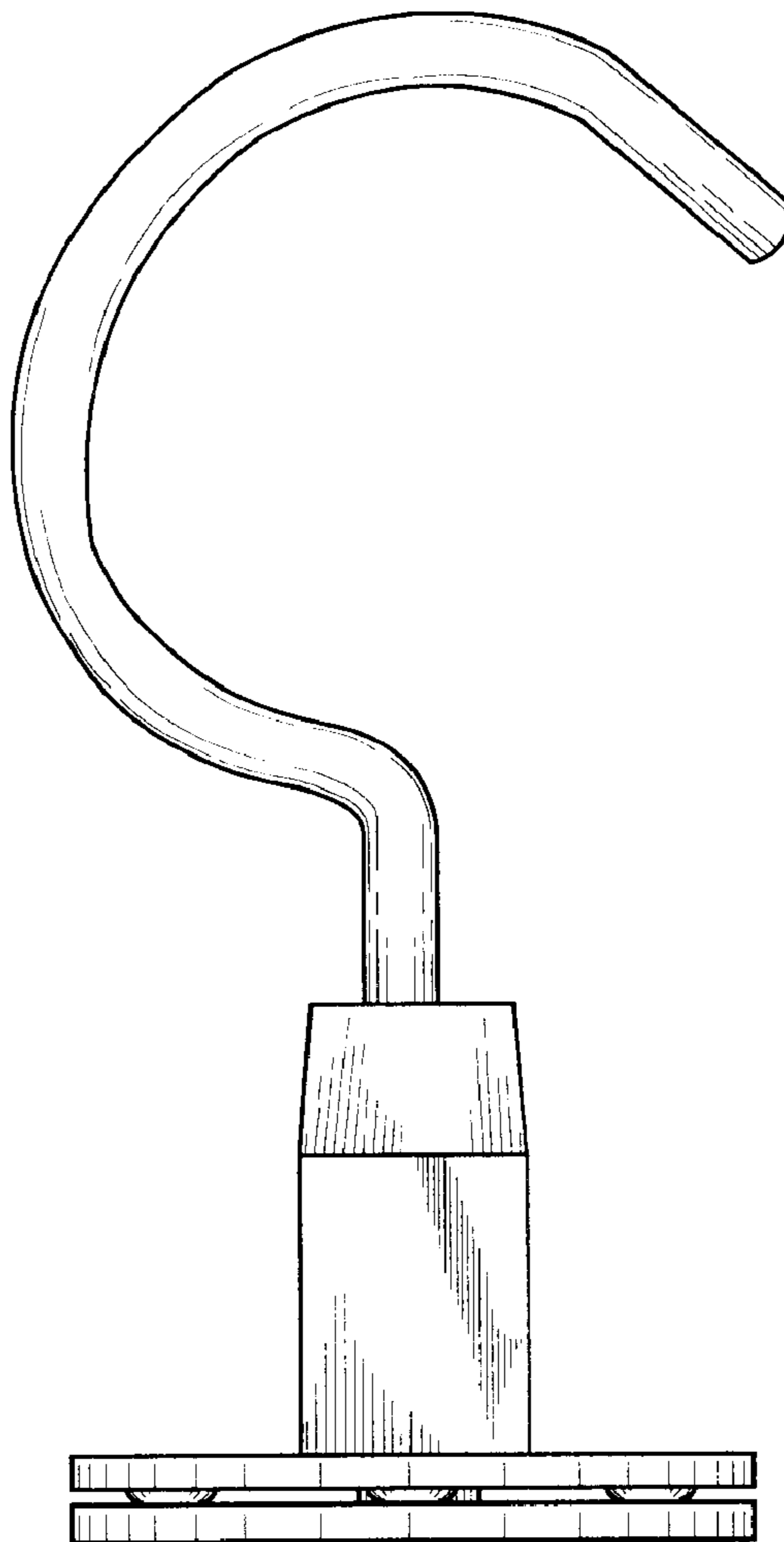

Fig. 1

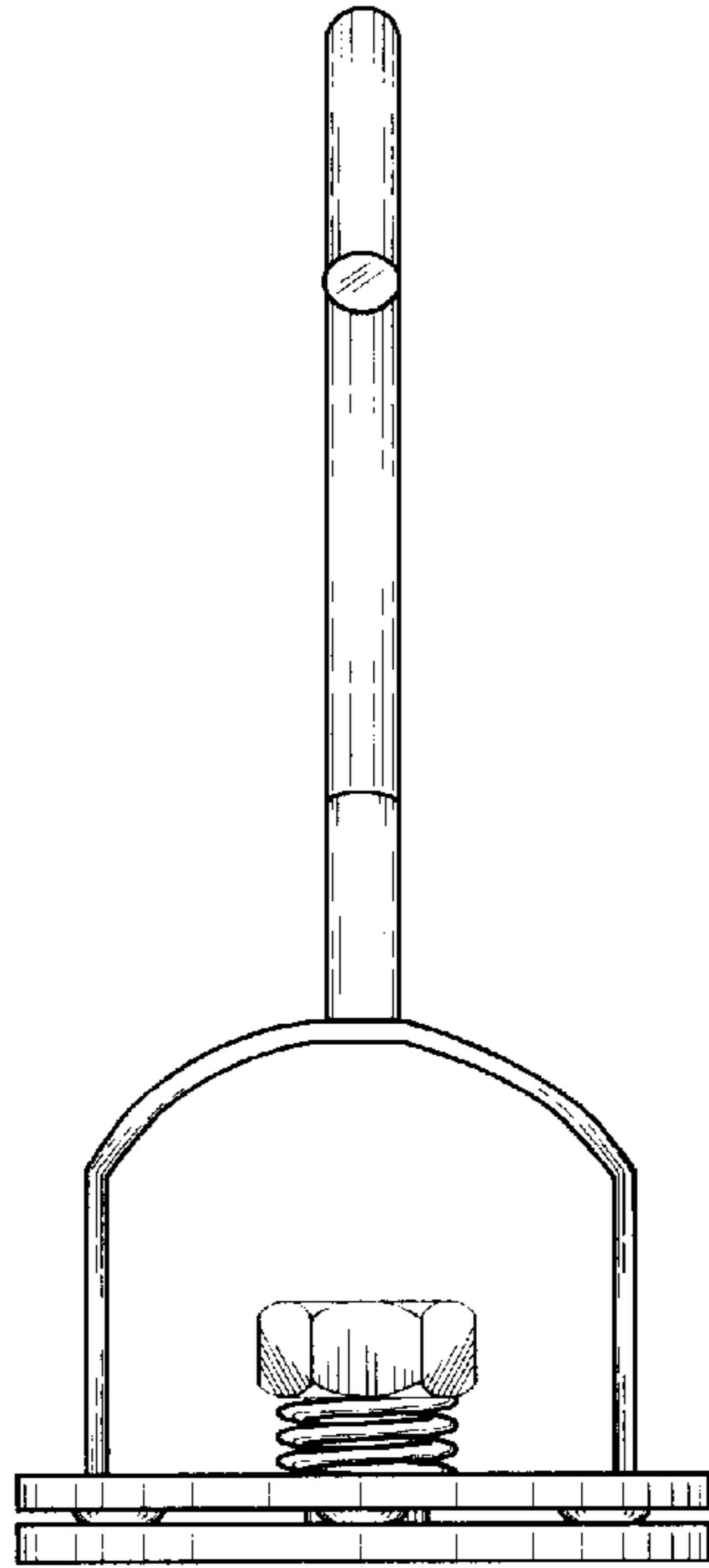

Fig. 2

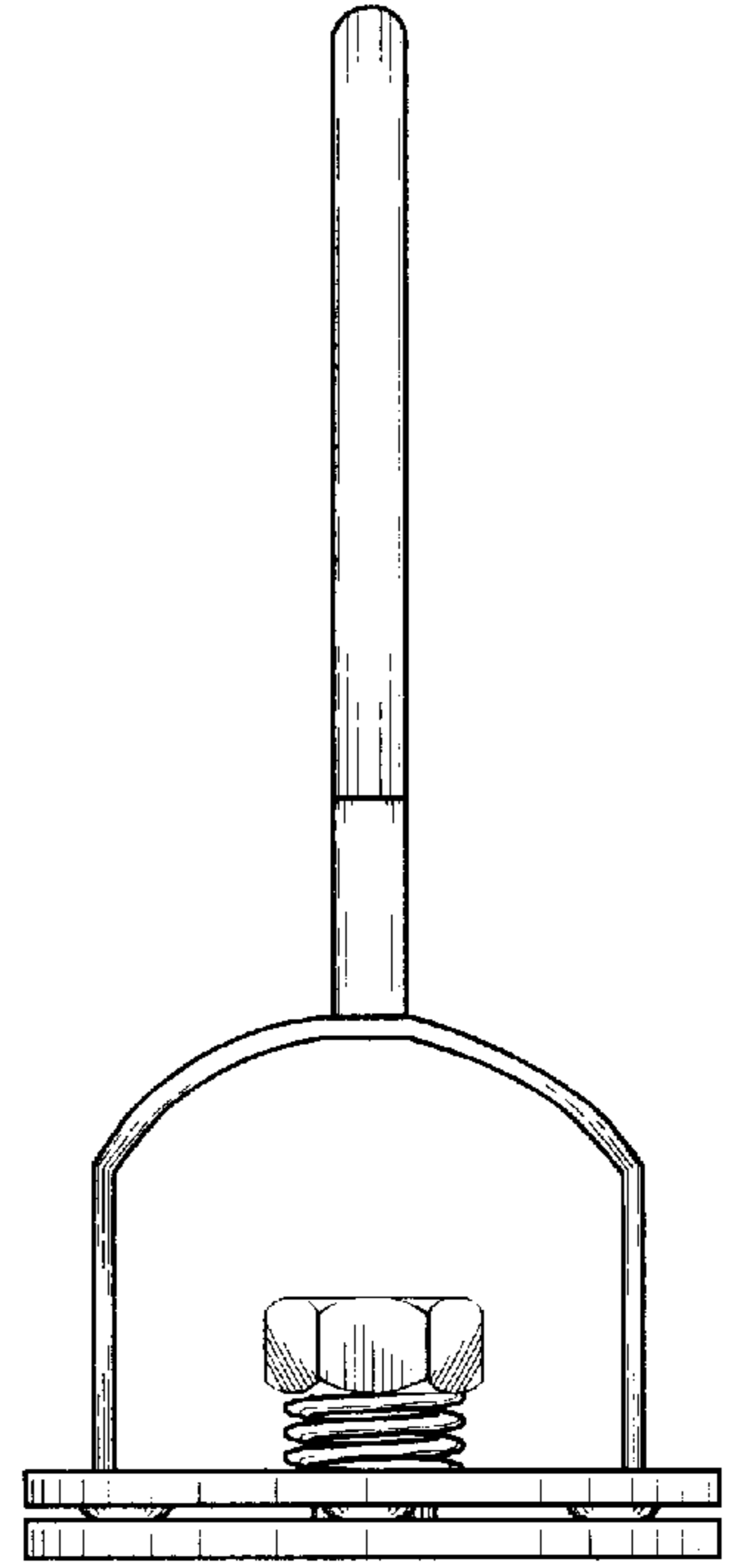

Fig. 3

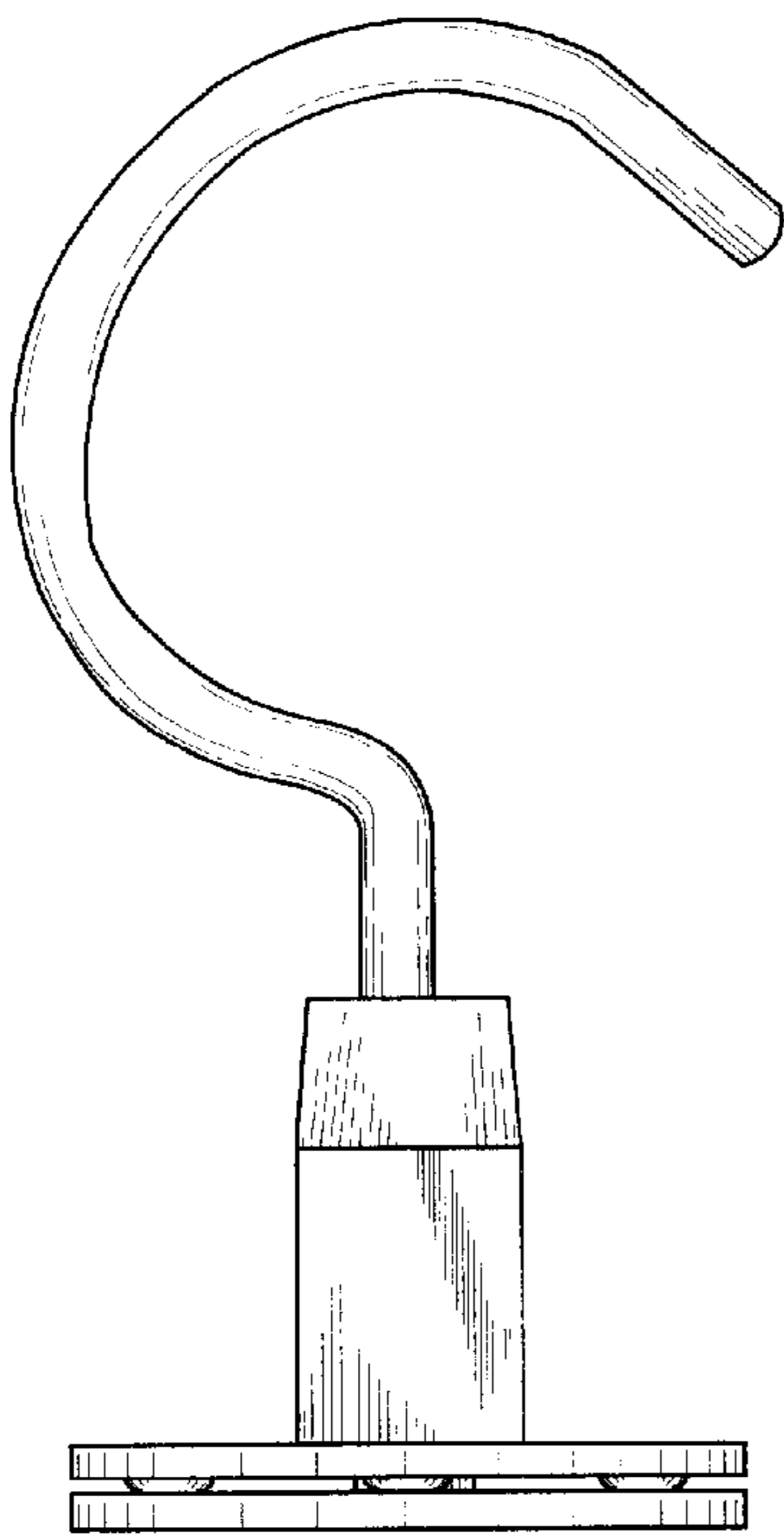

Fig. 4

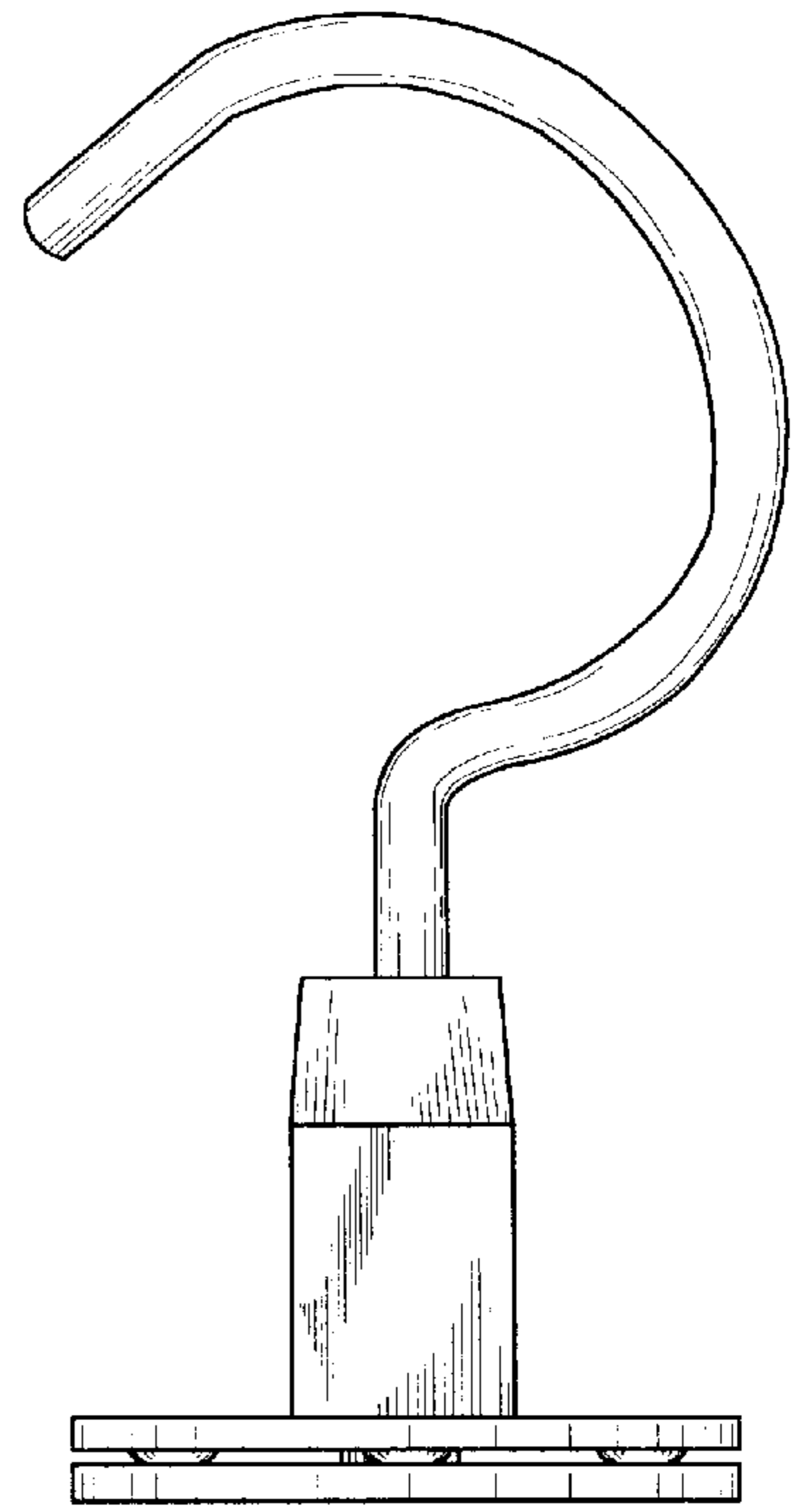

Fig. 5

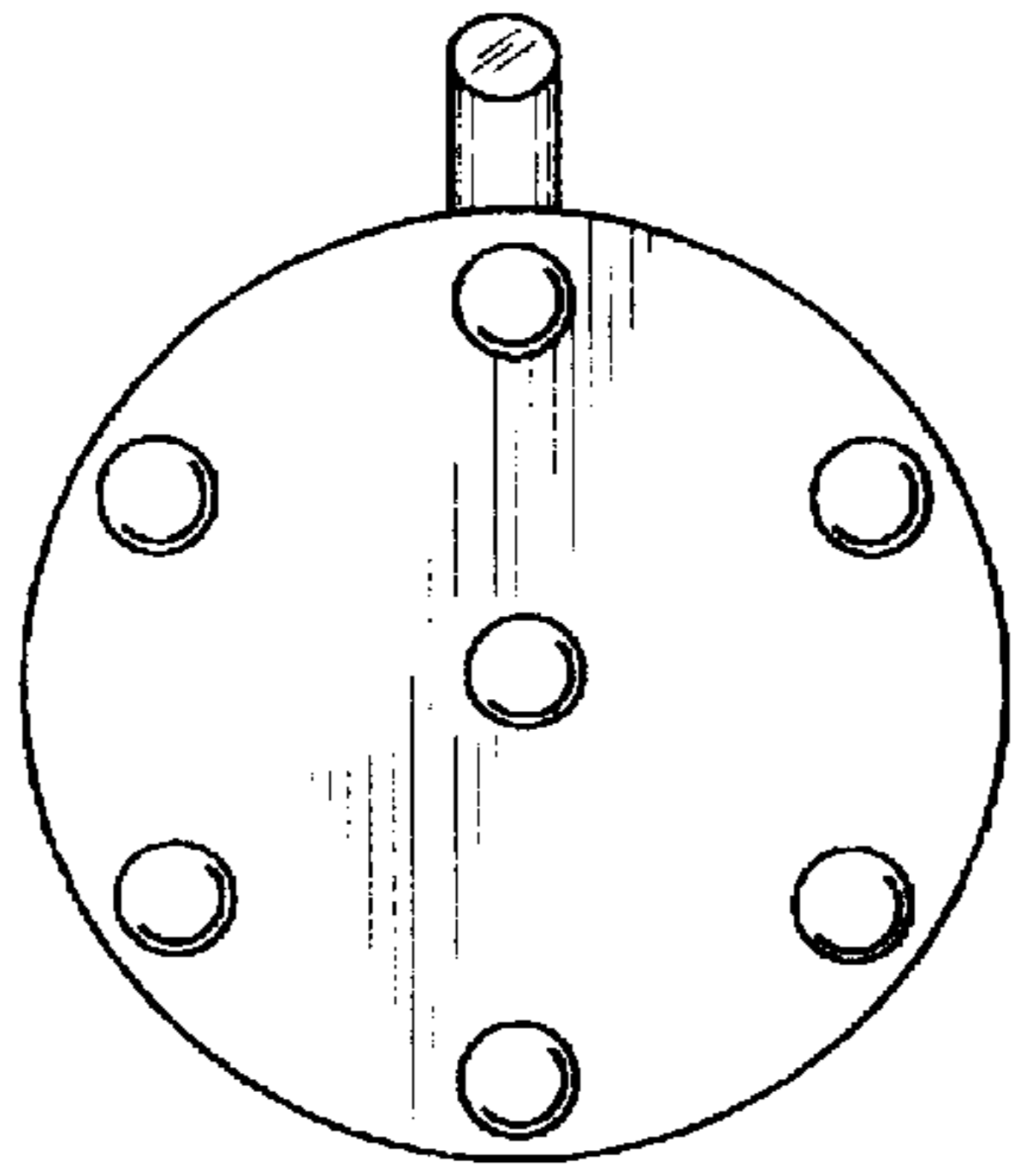

Fig. 6

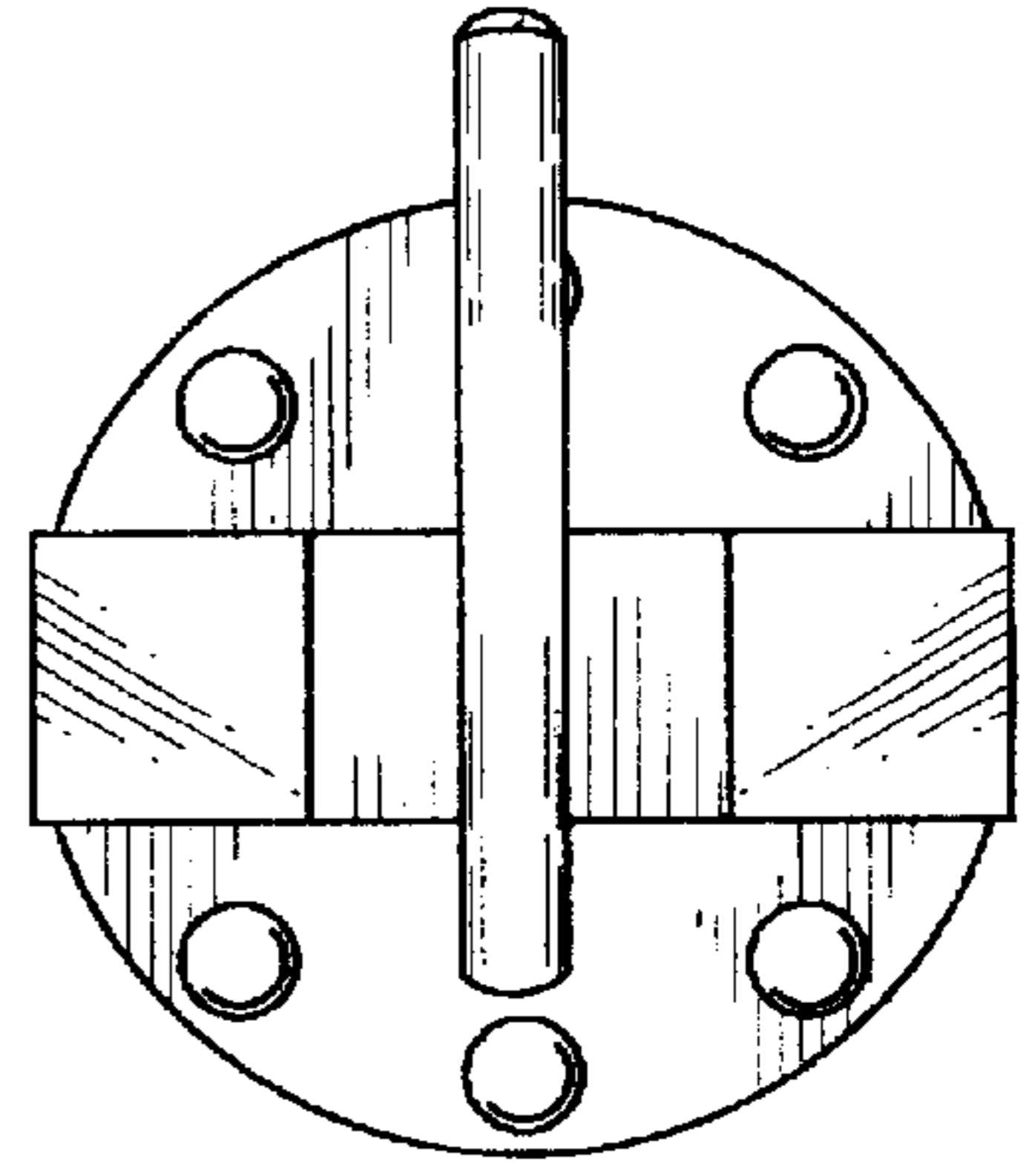

Fig. 7

