



US00D472570S

(12) **United States Design Patent**  
**Takahashi**

(10) **Patent No.:** **US D472,570 S**

(45) **Date of Patent:** **\*\* Apr. 1, 2003**

(54) **DATA PROJECTOR**

(75) Inventor: **Yoshihiro Takahashi**, Sagamihara (JP)

(73) Assignee: **PlusVision Corporation**, Tokyo (JP)

(\*\*) Term: **14 Years**

(21) Appl. No.: **29/153,440**

(22) Filed: **Nov. 13, 2001**

(30) **Foreign Application Priority Data**

May 25, 2001 (JP) ..... 2001-015002

(51) **LOC (7) Cl.** ..... **16-02**

(52) **U.S. Cl.** ..... **D16/230**

(58) **Field of Search** ..... D16/205, 221,  
D16/225, 230, 231, 234; D21/514; 353/115,  
119, 122

(56) **References Cited**

**U.S. PATENT DOCUMENTS**

- D387,795 S \* 12/1997 Sakamoto ..... D16/231
- D400,903 S \* 11/1998 Miyagawa et al. .... D16/225
- D437,337 S \* 2/2001 Kawasaki et al. .... D16/230
- D437,607 S \* 2/2001 Takahashi ..... D16/230
- D449,060 S \* 10/2001 Saeki et al. .... D16/230
- D450,076 S \* 11/2001 Fujimaki ..... D16/230

D454,360 S \* 3/2002 Shimizu et al. .... D16/230  
2002/0048001 A1 \* 4/2002 Fujimori ..... 353/119

\* cited by examiner

*Primary Examiner*—Adir Aronovich

(74) *Attorney, Agent, or Firm*—Darby & Darby

(57) **CLAIM**

The ornamental design for a data projector, as shown and described.

**DESCRIPTION**

FIG. 1 is a top plan view of a data projector showing my new design;  
 FIG. 2 is a front elevational view thereof;  
 FIG. 3 is a left side elevational view thereof;  
 FIG. 4 is a right side elevational view thereof;  
 FIG. 5 is a bottom plan view thereof;  
 FIG. 6 is a cross-sectional view thereof taken along line 6—6 with inner workings omitted;  
 FIG. 7 is a cross-sectional view thereof taken along line 7—7 with inner workings omitted;  
 FIG. 8 is a rear view thereof;  
 FIG. 9 is a cross-sectional view thereof taken along line 9—9 with inner workings omitted; and,  
 FIG. 10 is a perspective view thereof from front.

**1 Claim, 5 Drawing Sheets**

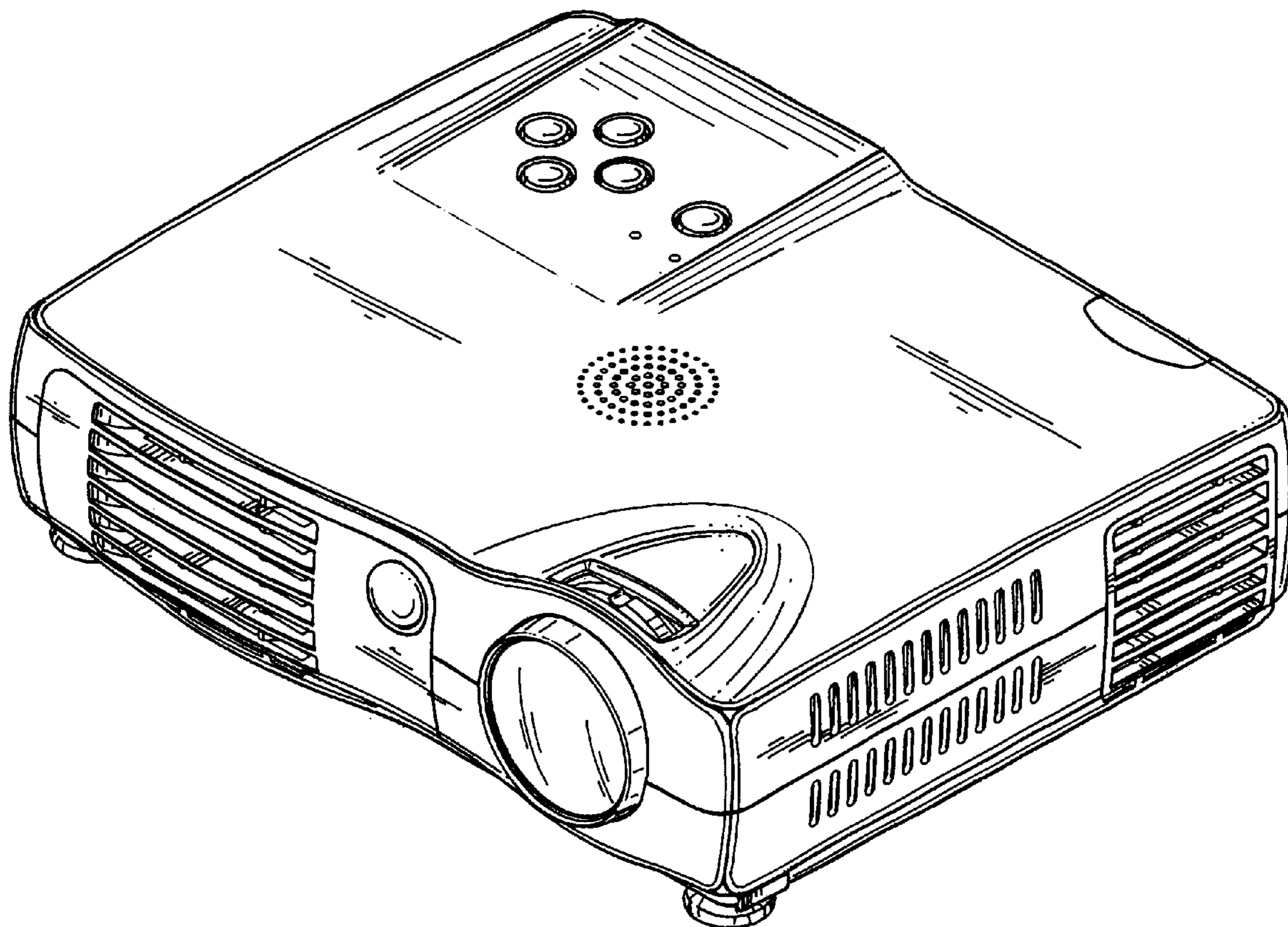

# Fig. 1

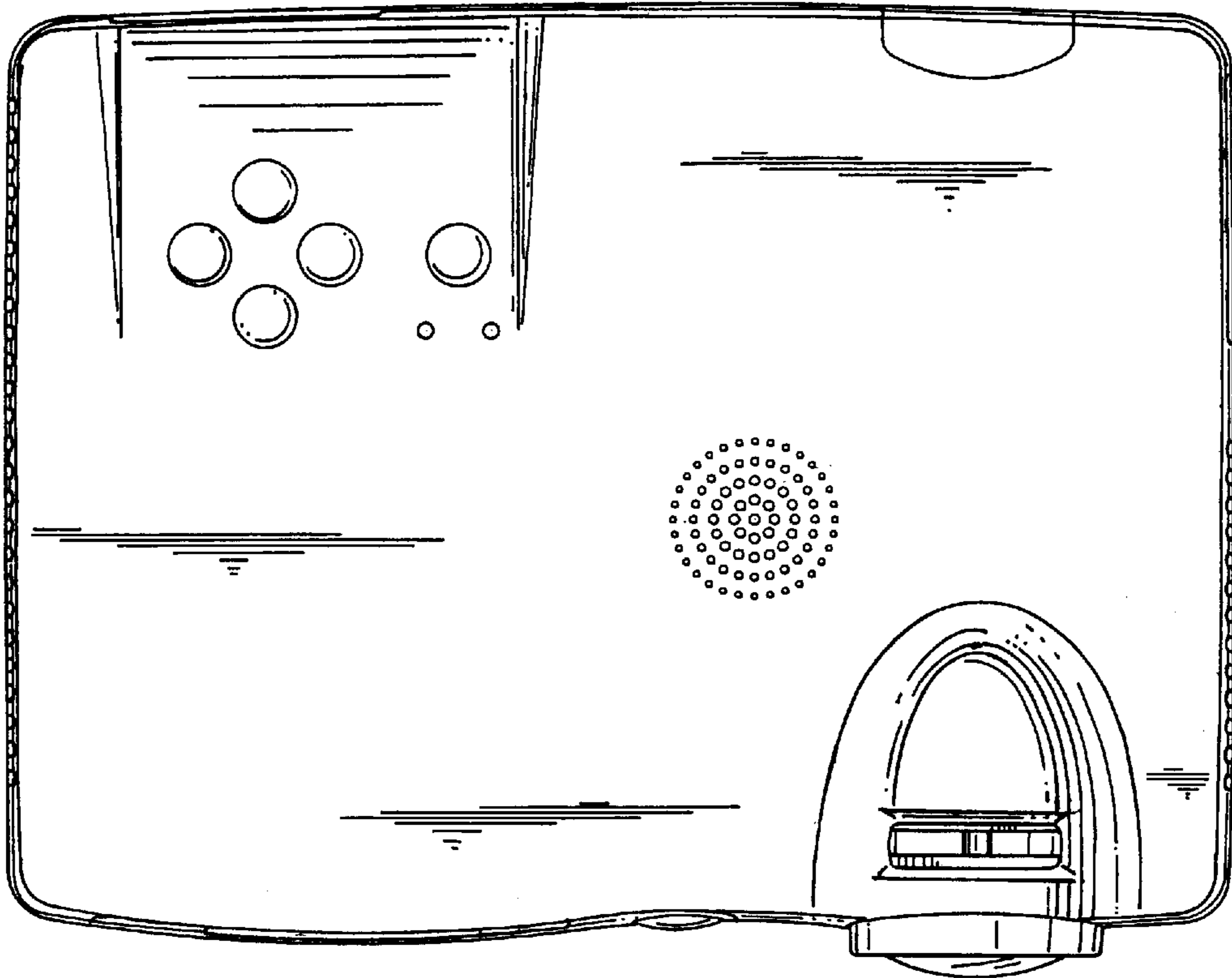

# Fig. 2

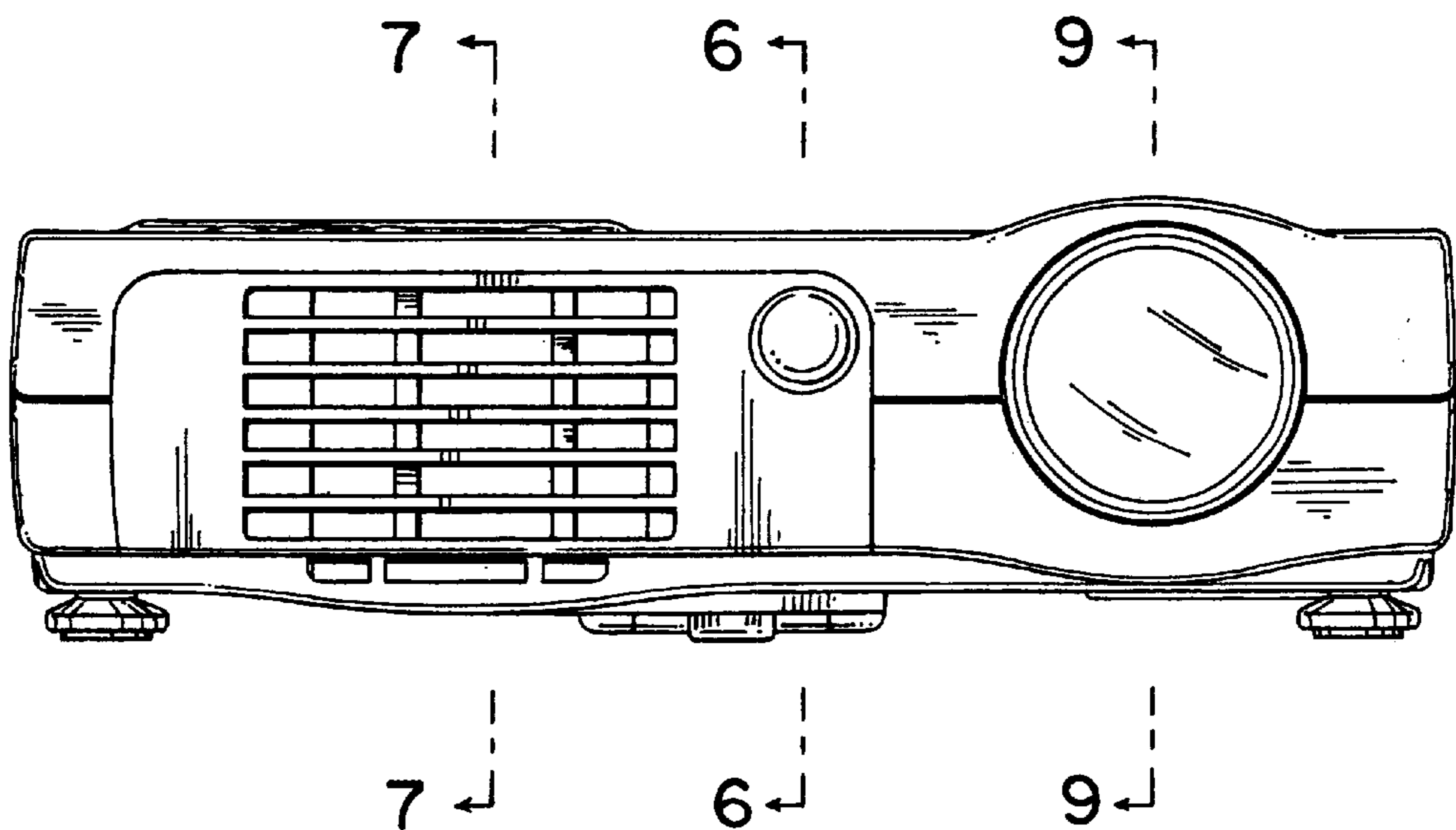

Fig. 3

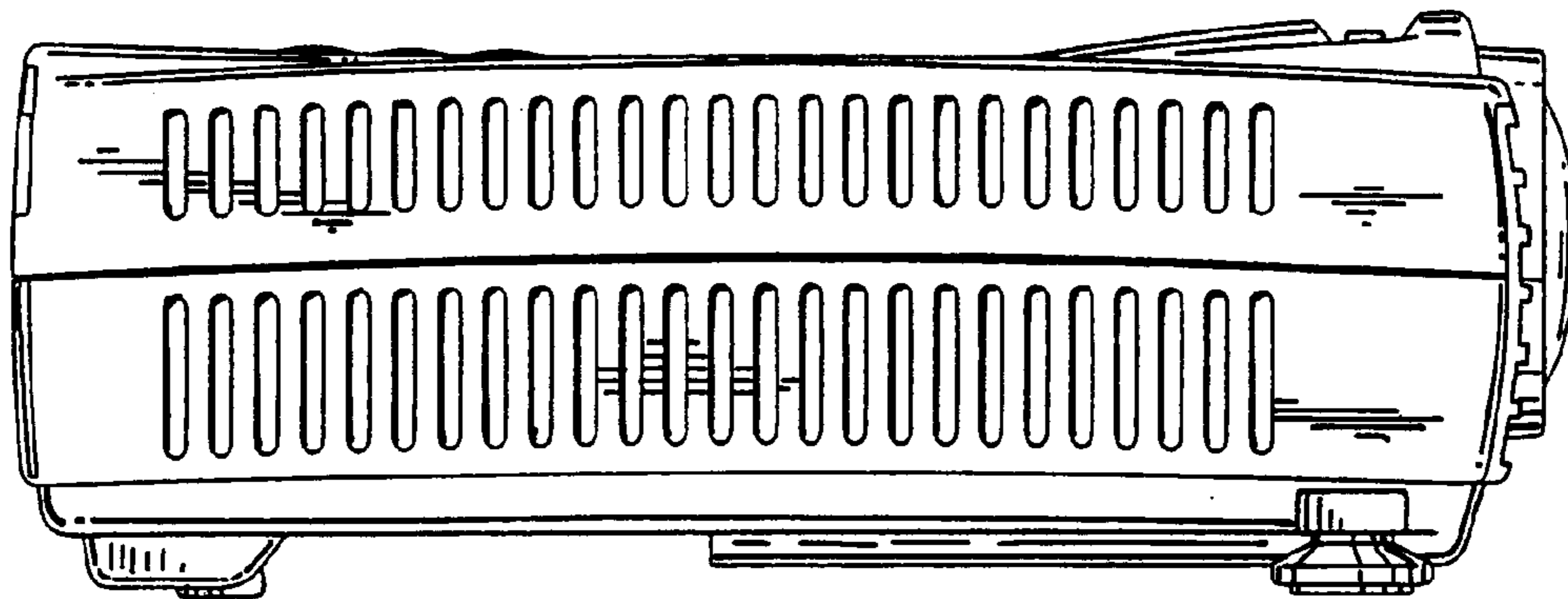

Fig. 4

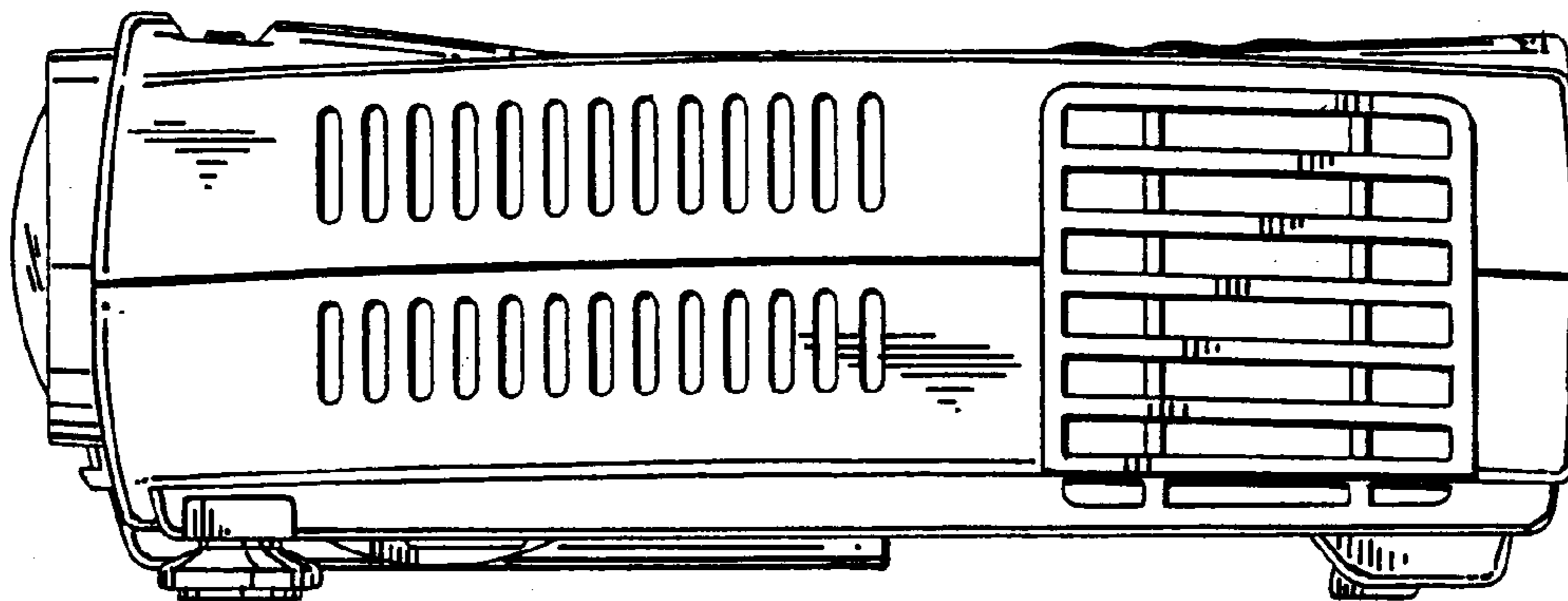

Fig. 5

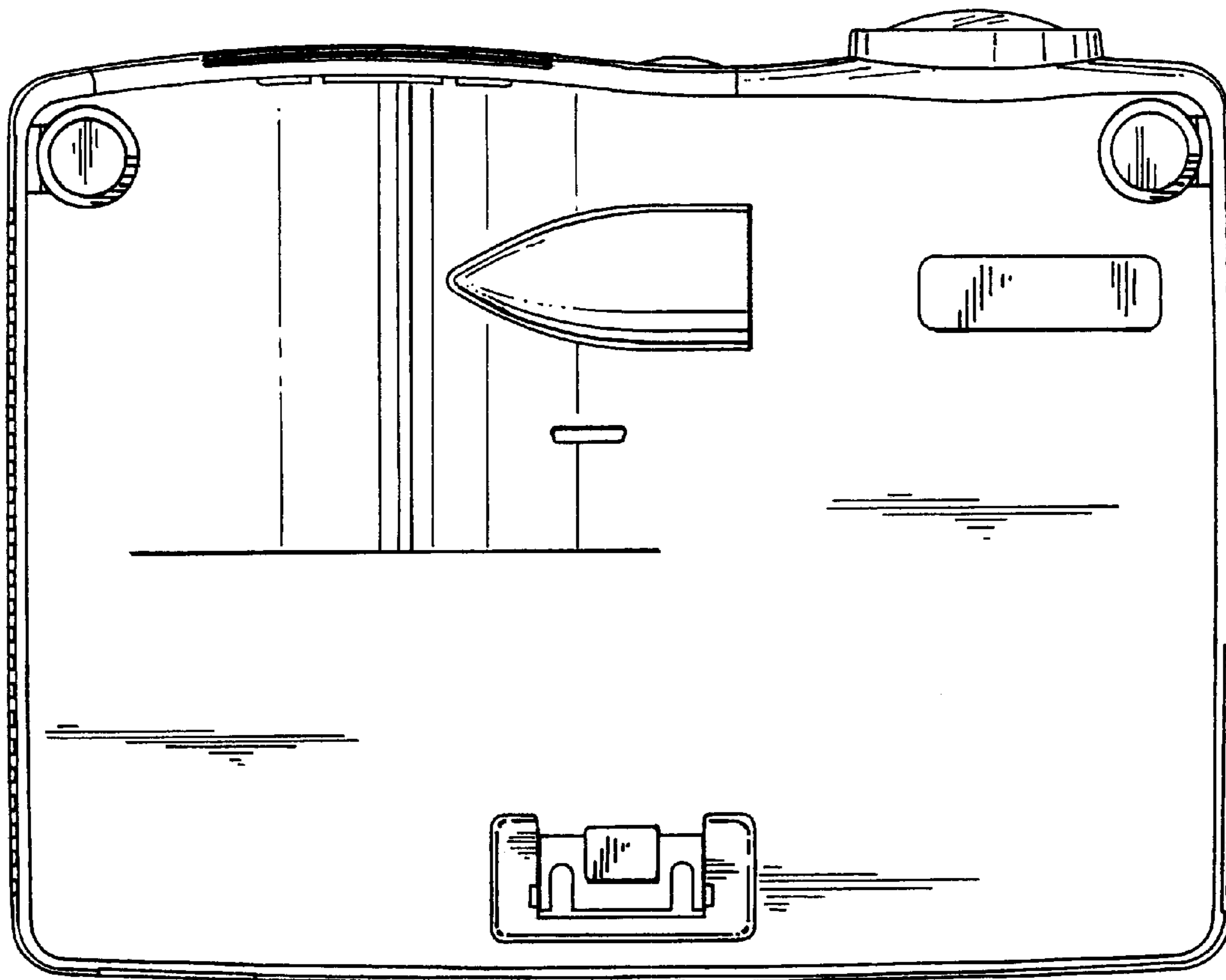

Fig. 6

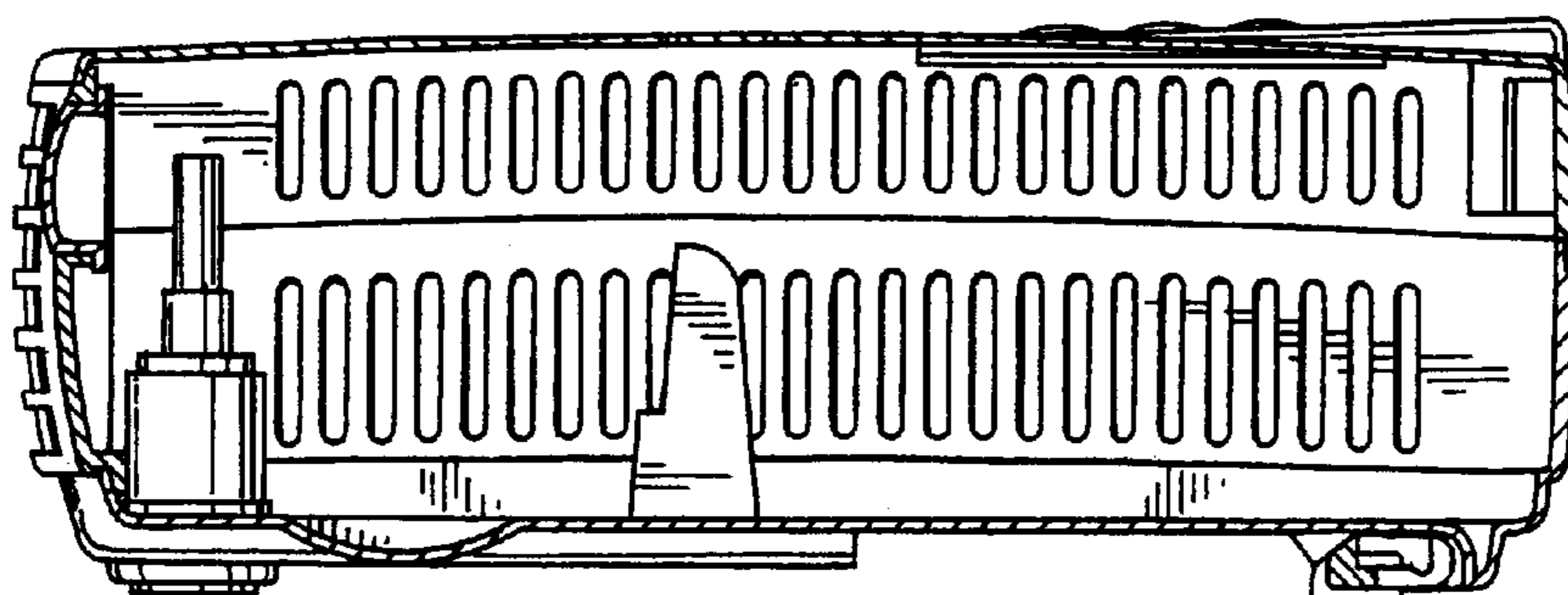

Fig. 7

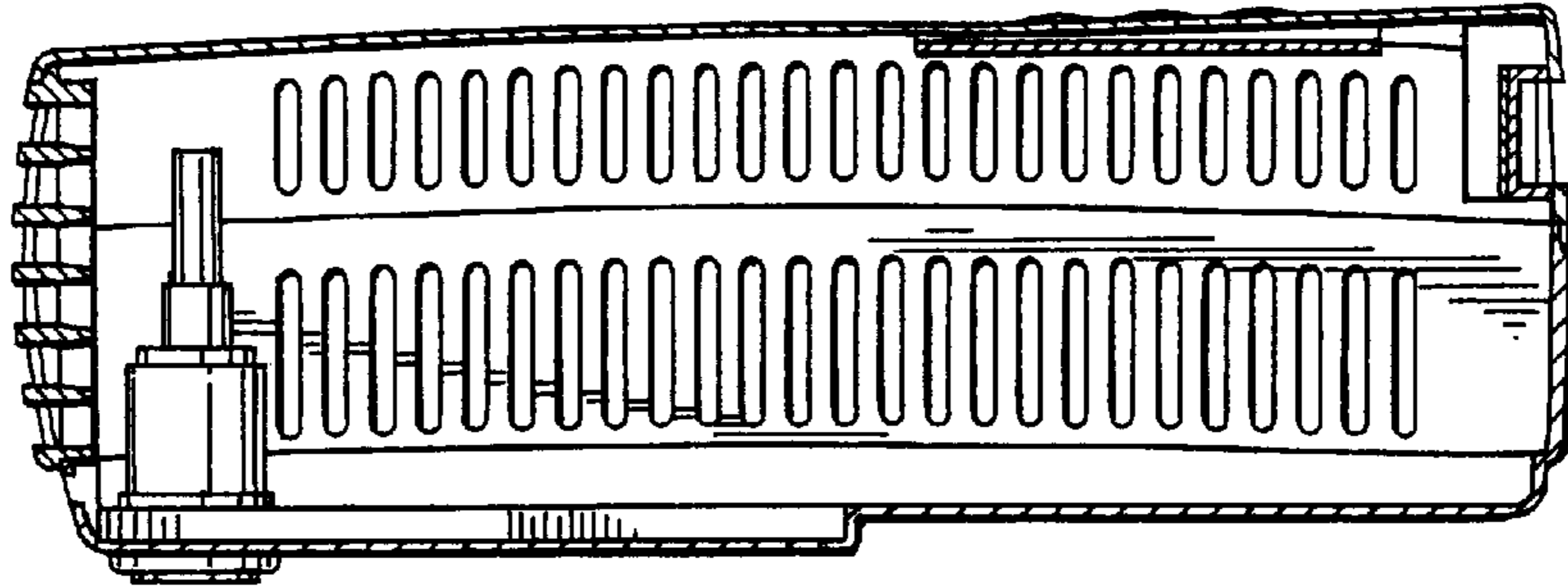

Fig. 8

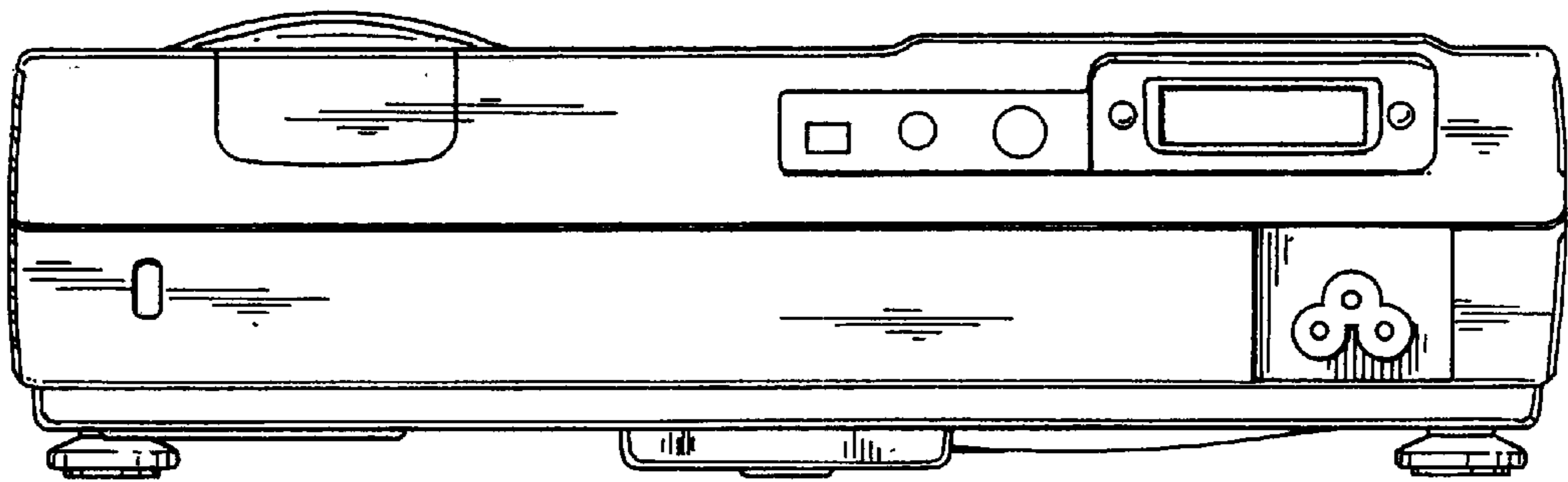

Fig. 9

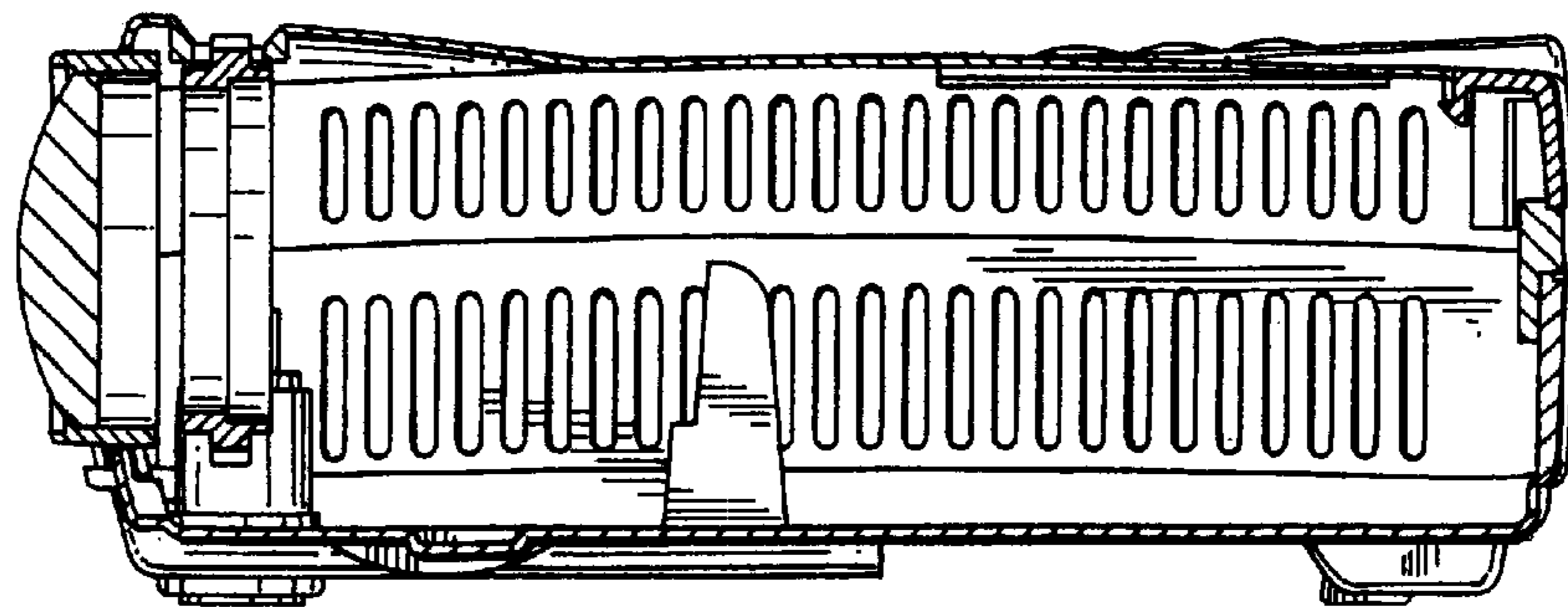

Fig. 10

