



US00D472557S

(12) **United States Design Patent**
Kadota

(10) **Patent No.:** **US D472,557 S**

(45) **Date of Patent:** **** Apr. 1, 2003**

(54) **INPUT KEY**

(75) **Inventor:** **Toshihiko Kadota**, Kawasaki (JP)

(73) **Assignee:** **Canon Kabushiki Kaisha**, Tokyo (JP)

(**) **Term:** **14 Years**

(21) **Appl. No.:** **29/164,577**

(22) **Filed:** **Jul. 29, 2002**

(30) **Foreign Application Priority Data**

Feb. 1, 2002 (JP) 2002-002333
Feb. 1, 2002 (JP) 2002-002334

(51) **LOC (7) Cl.** **14-02**

(52) **U.S. Cl.** **D14/456**

(58) **Field of Search** D14/454, 455,
D14/456, 402, 408, 391-398; D18/1, 7;
238/145 A, 145 R; 200/5 R, 5 A, 6 R, 6 A;
345/160, 168; 364/708.1; 400/472, 484-486,
489, 682; D19/59, 60

(56) **References Cited**

U.S. PATENT DOCUMENTS

D319,050 S * 8/1991 Korellis et al. D14/456
D330,706 S * 11/1992 San-Yih D14/408
D376,592 S * 12/1996 Tsai D14/398
D417,665 S * 12/1999 Isonaga D14/408
D442,591 S * 5/2001 Bailly D14/398

* cited by examiner

Primary Examiner—Kay H. Chin

(74) *Attorney, Agent, or Firm*—Fitzpatrick, Cella, Harper & Scinto

(57) **CLAIM**

The ornamental design for an input key, as shown and described.

DESCRIPTION

FIG. 1 is a front view of an input key illustrated as a first embodiment of my new design;

FIG. 2 is a rear view thereof;

FIG. 3 is a top plan view thereof;

FIG. 4 is a bottom plan view thereof;

FIG. 5 is a left side view thereof;

FIG. 6 is a right side view thereof;

FIG. 7 is a perspective view thereof.

FIG. 8 is a front view of an input key illustrated as a second embodiment of my new design;

FIG. 9 is a rear view thereof;

FIG. 10 is a top plan view thereof;

FIG. 11 is a bottom plan view thereof;

FIG. 12 is a left side view thereof;

FIG. 13 is a right side view thereof; and,

FIG. 14 is a perspective view thereof.

The chain-link broken lines define the bounds of the claimed design but form no part thereof.

1 Claim, 2 Drawing Sheets

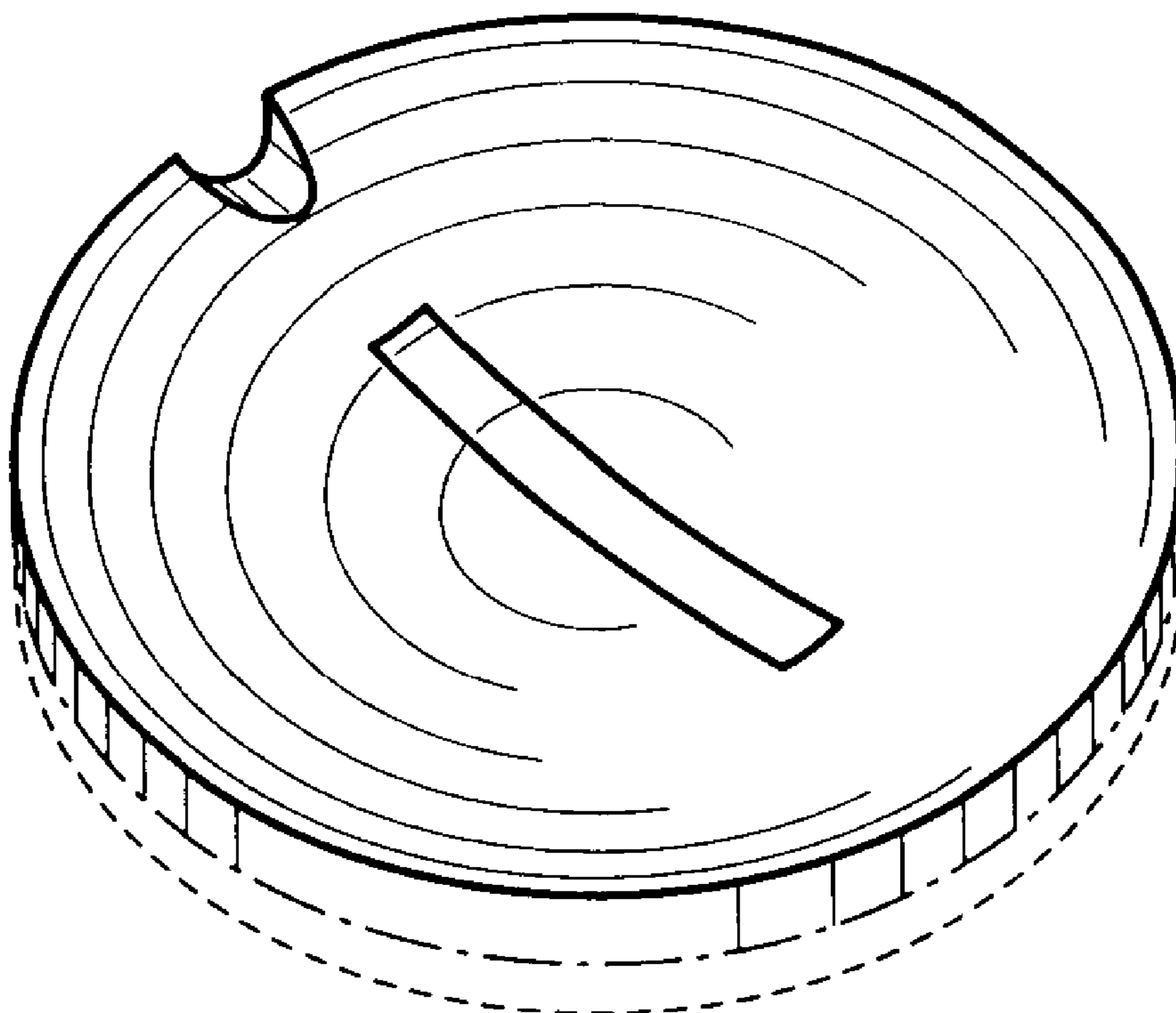

FIG. 1

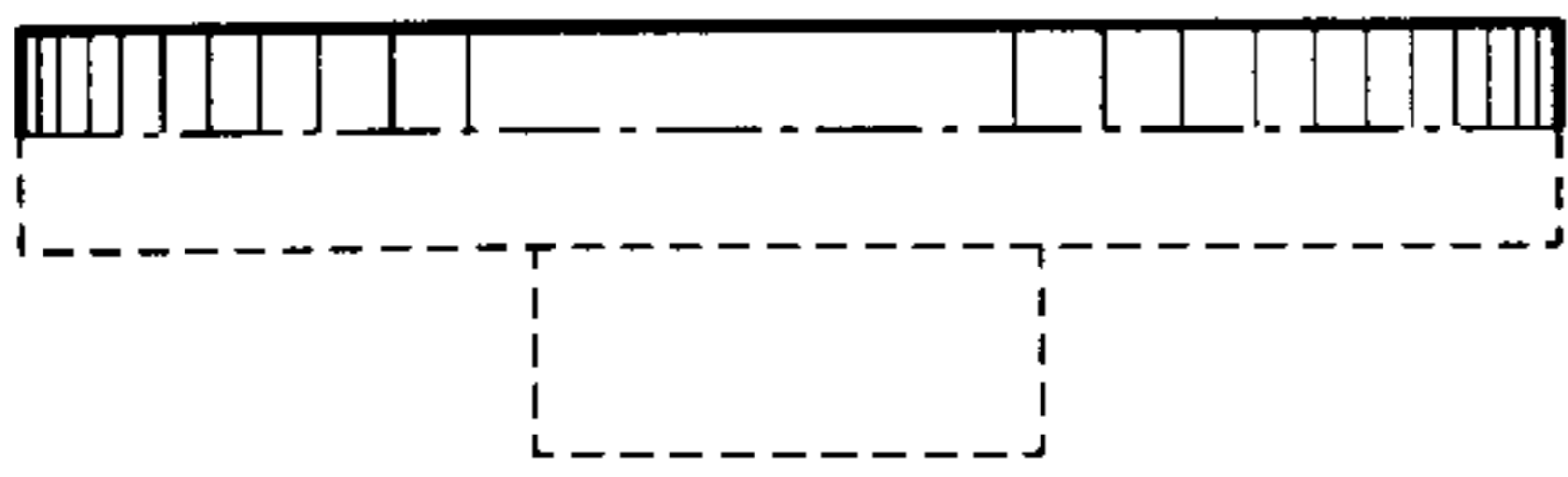

FIG. 2

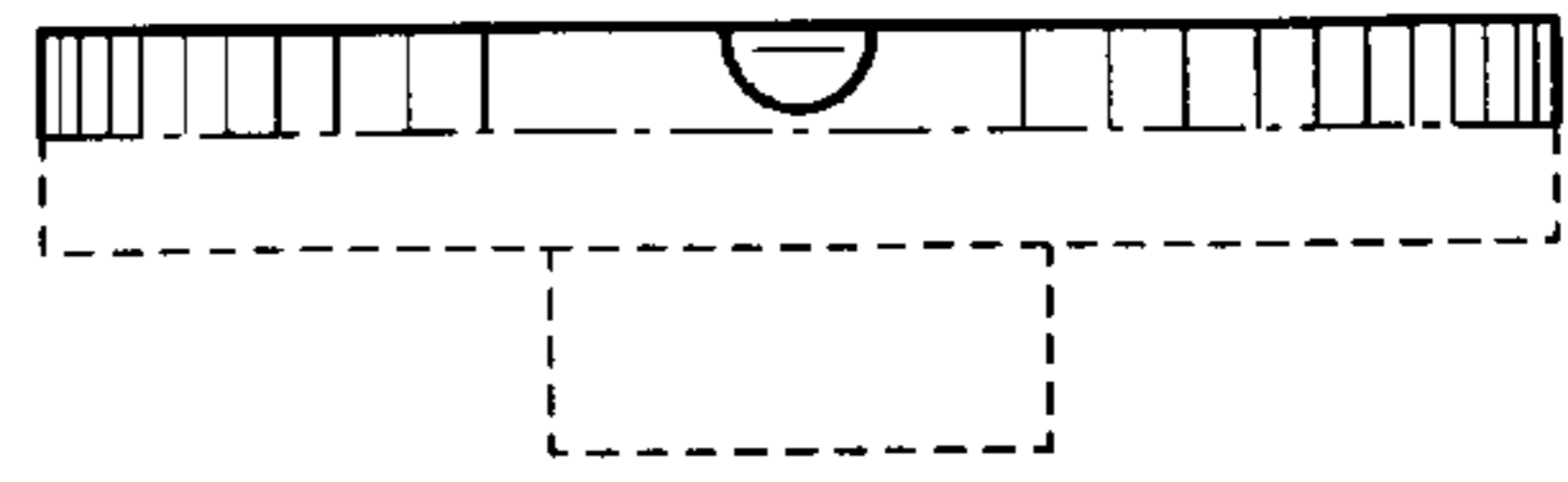

FIG. 3

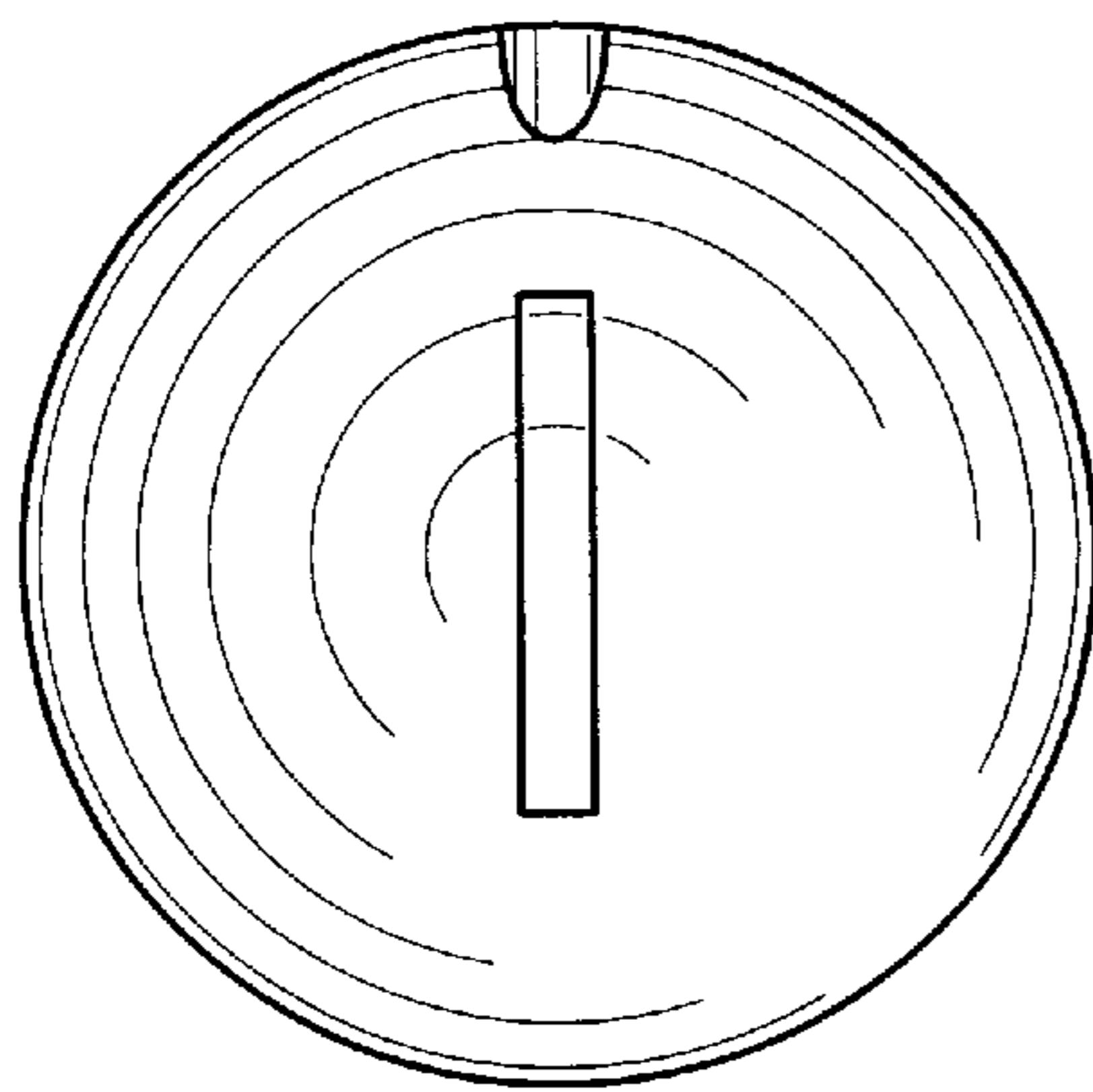

FIG. 4

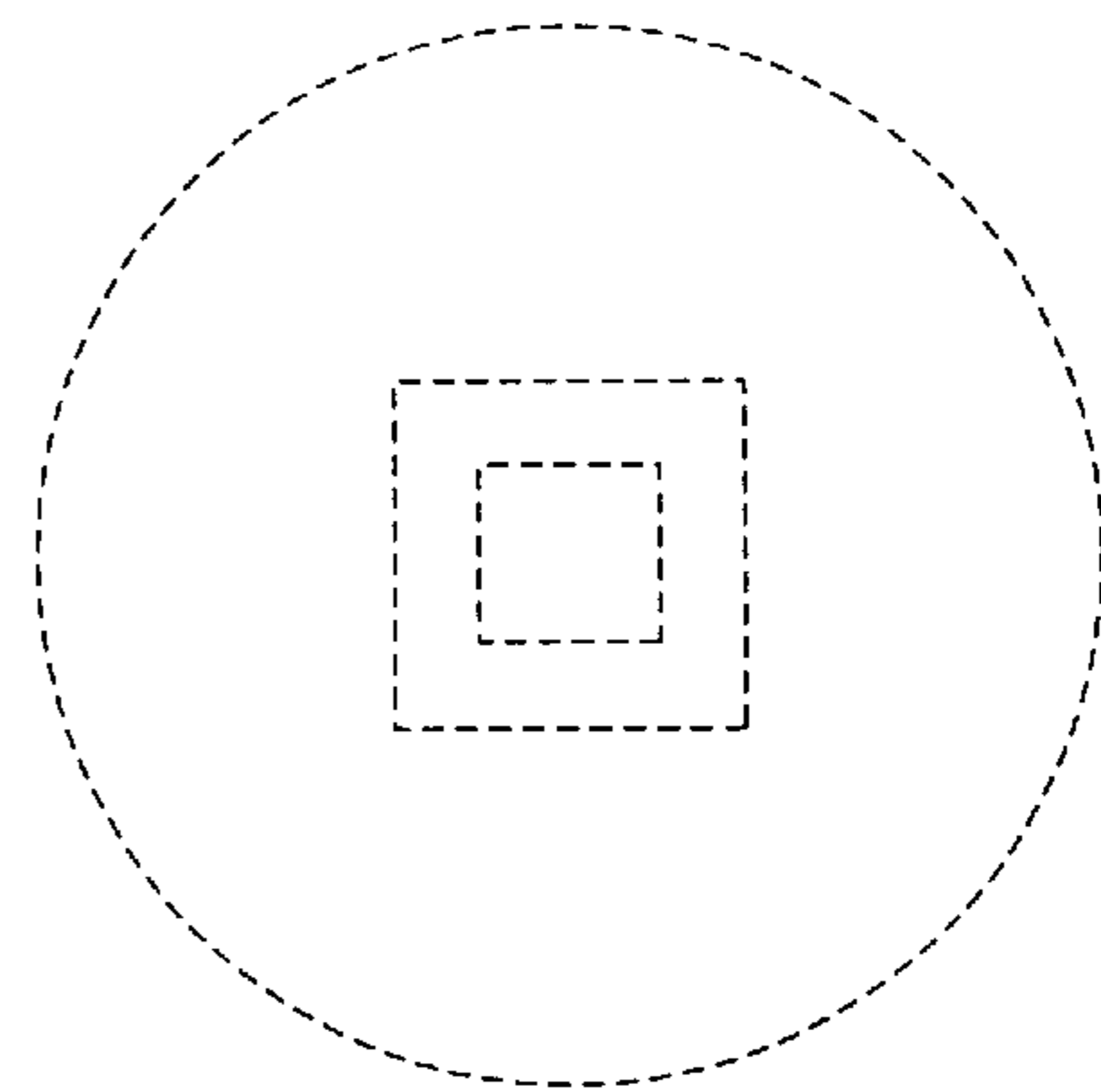

FIG. 5

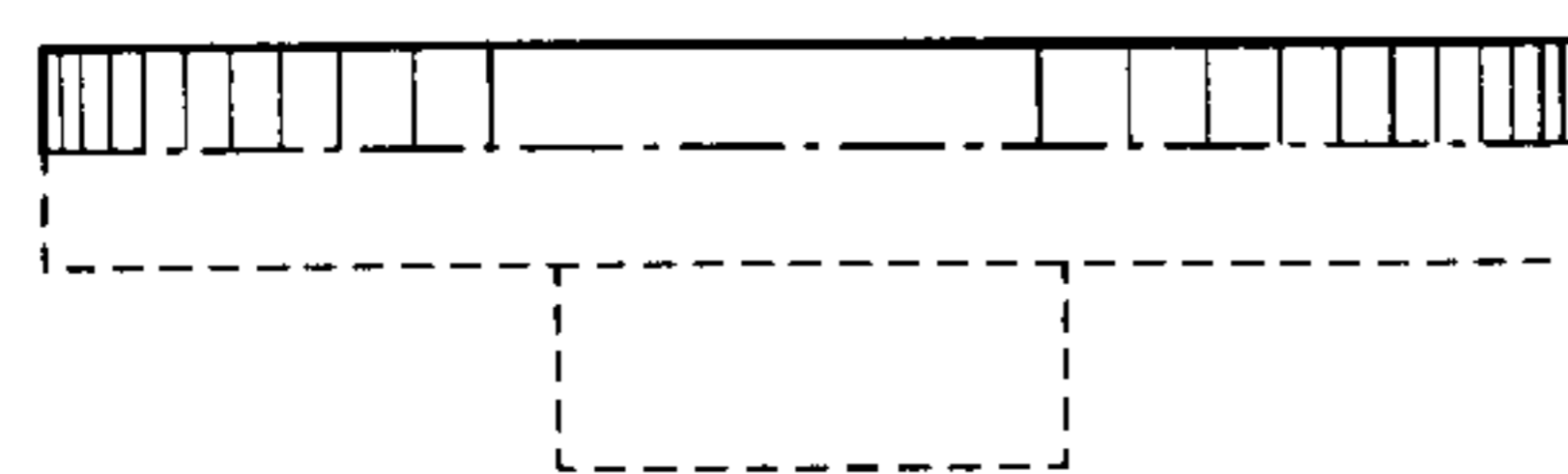

FIG. 6

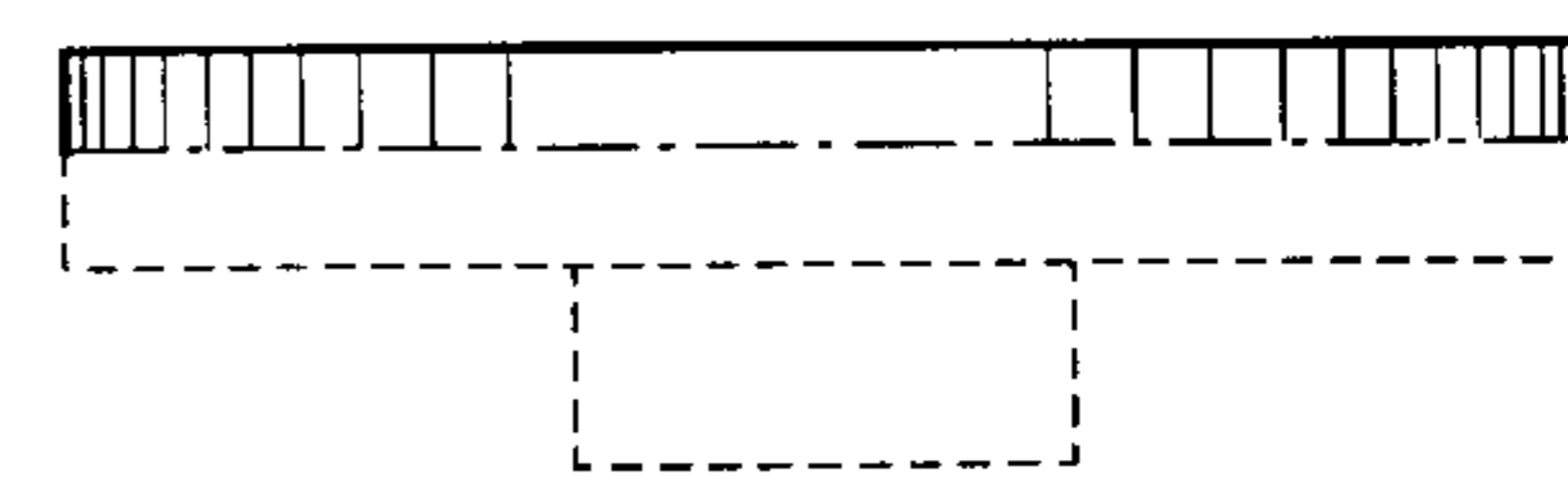

FIG. 7

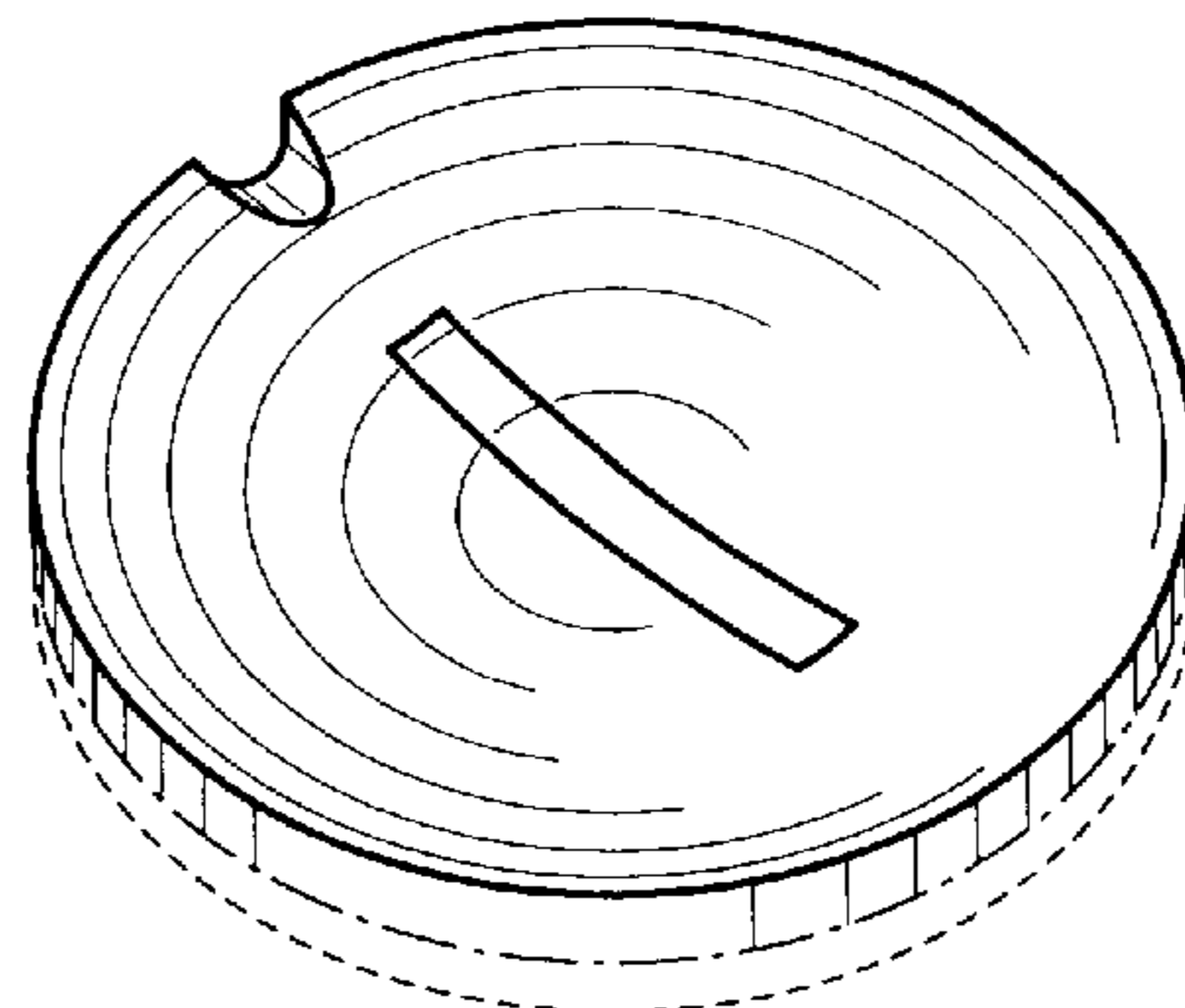

FIG. 8

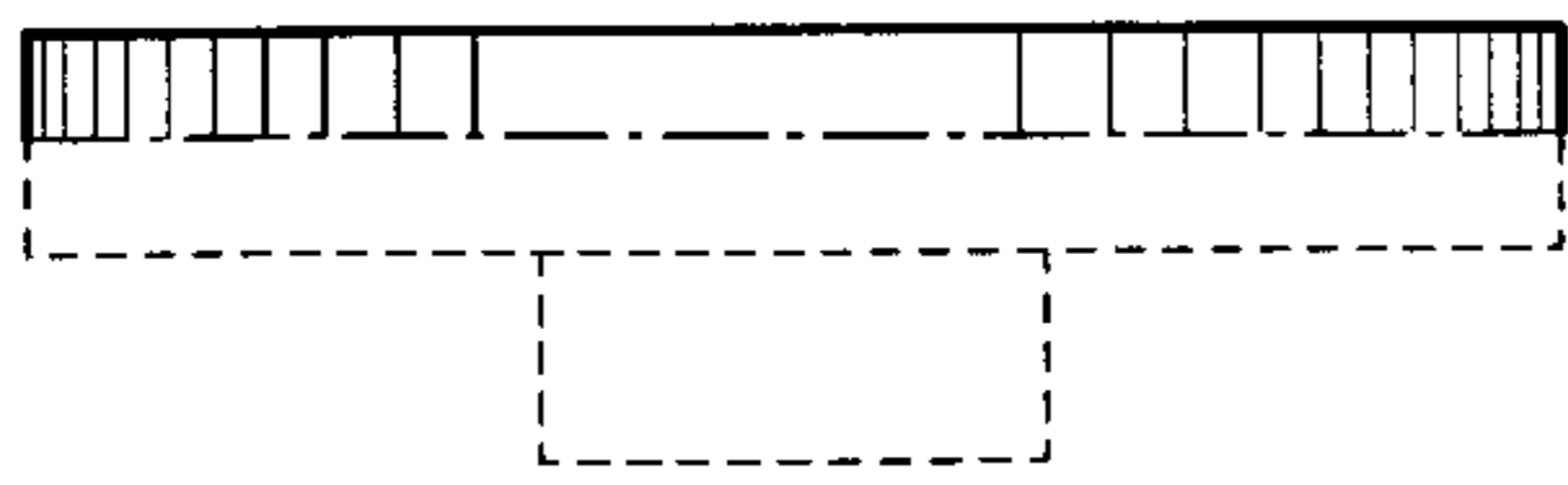

FIG. 9

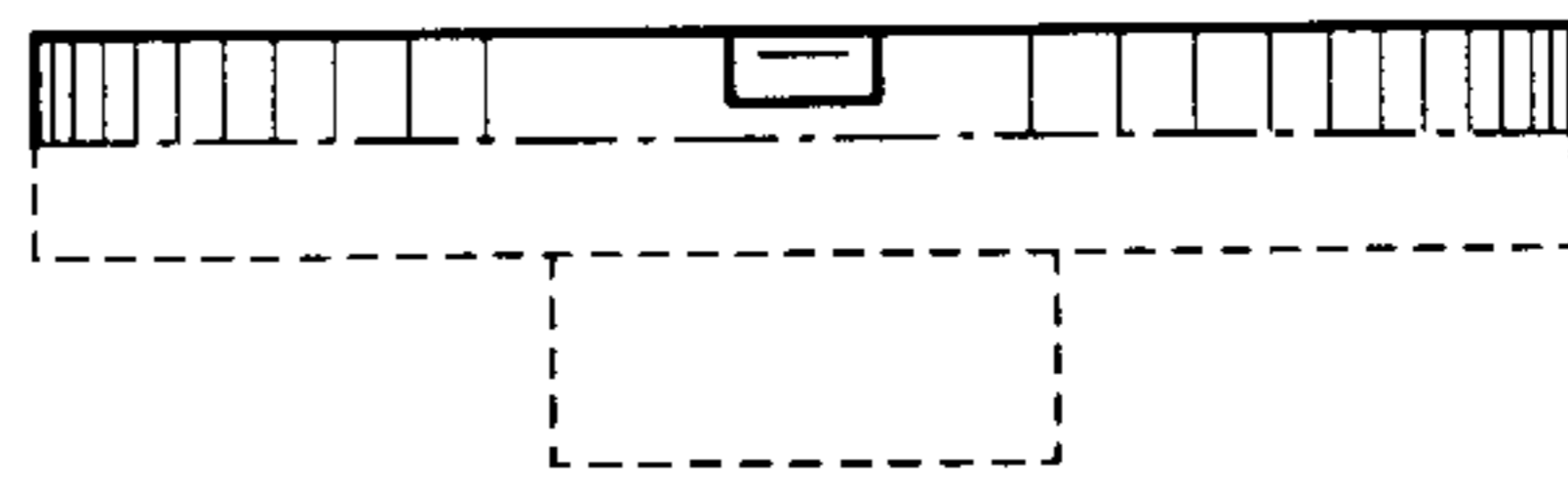

FIG. 10

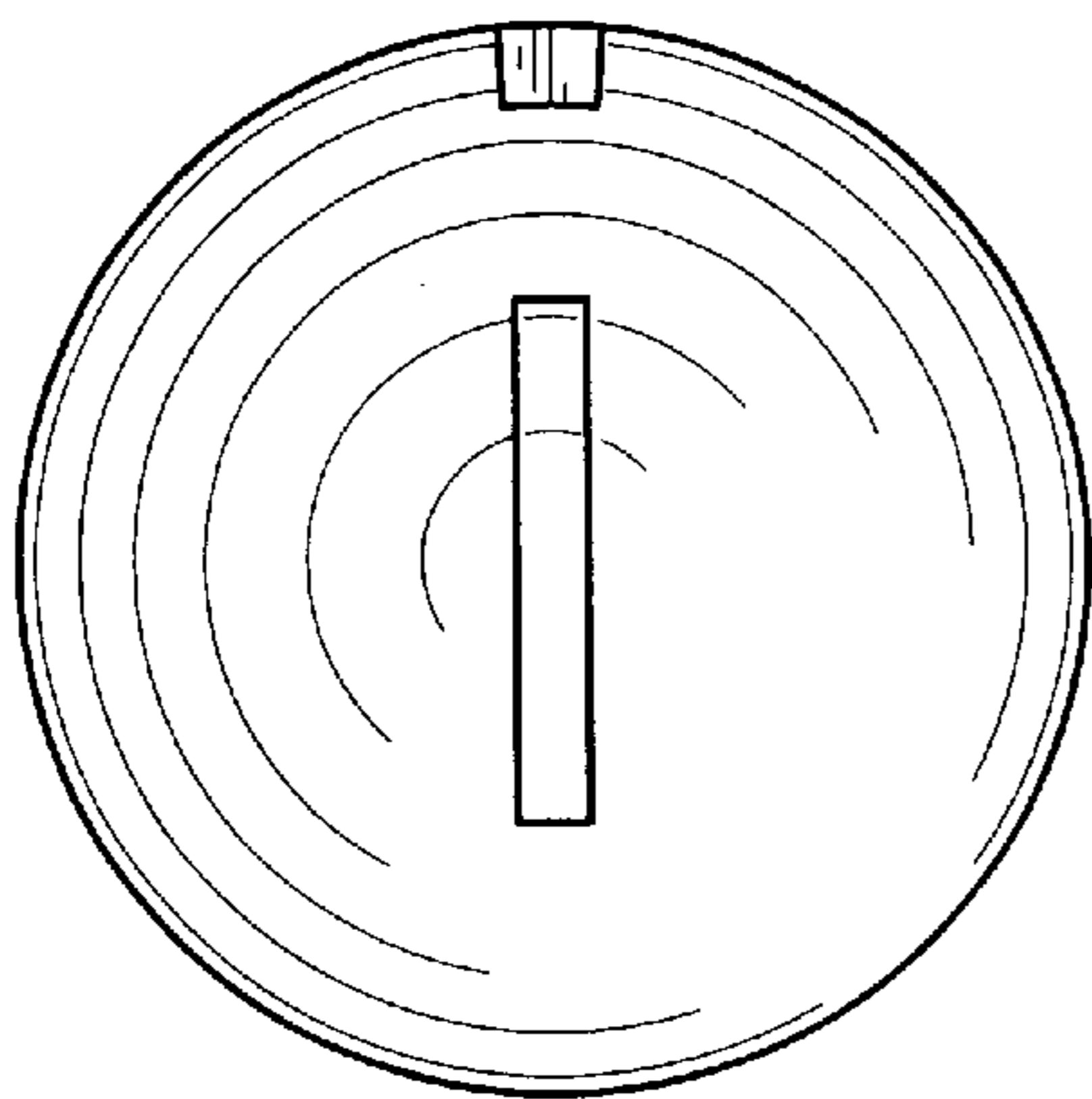

FIG. 11

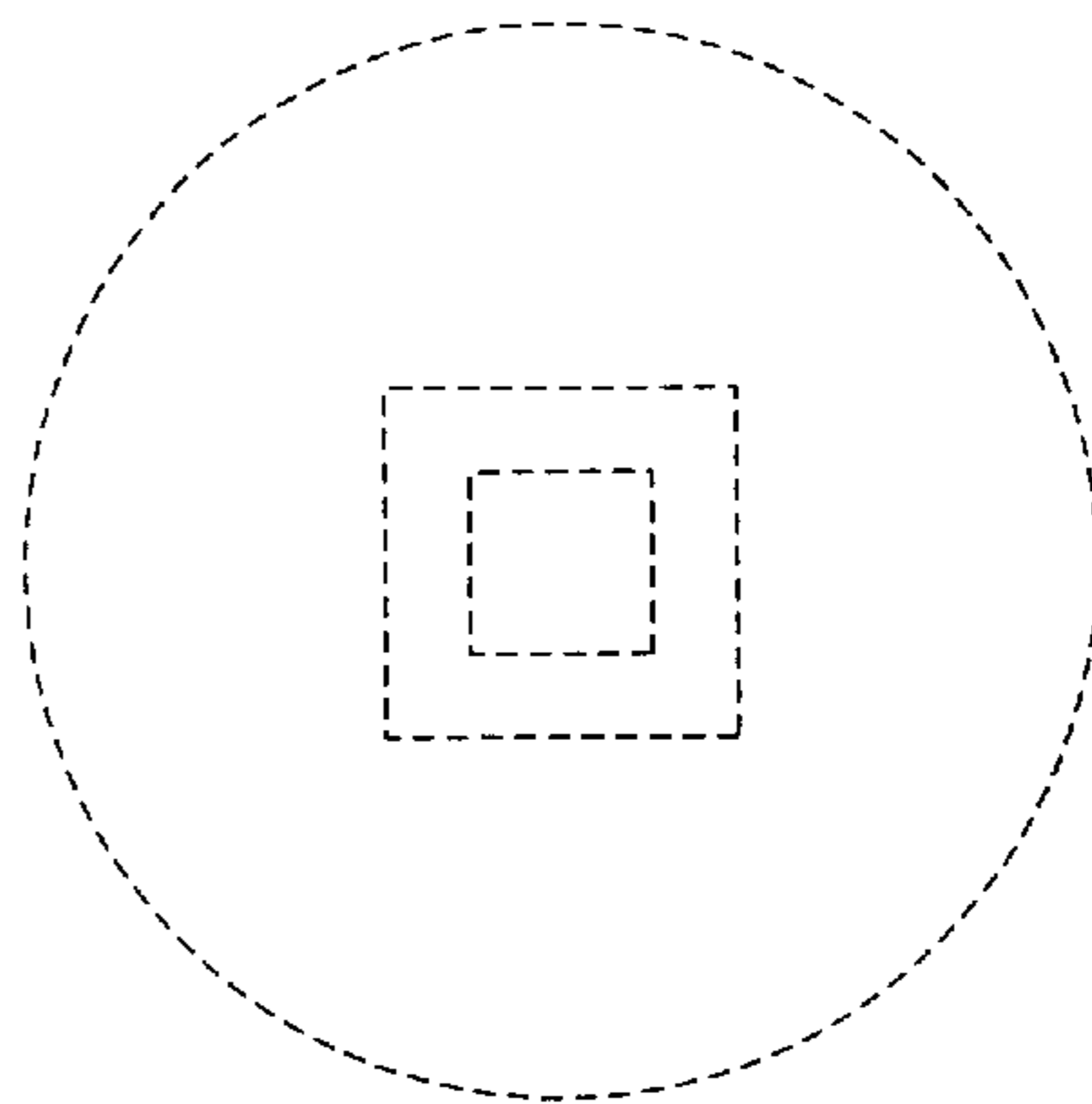

FIG. 12

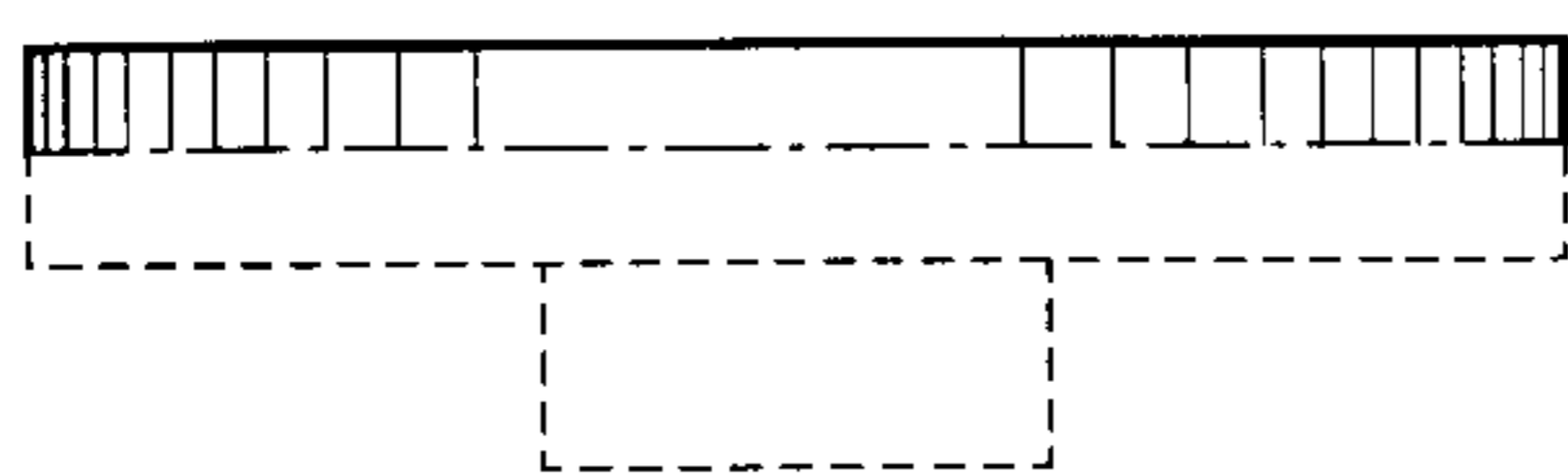

FIG. 13

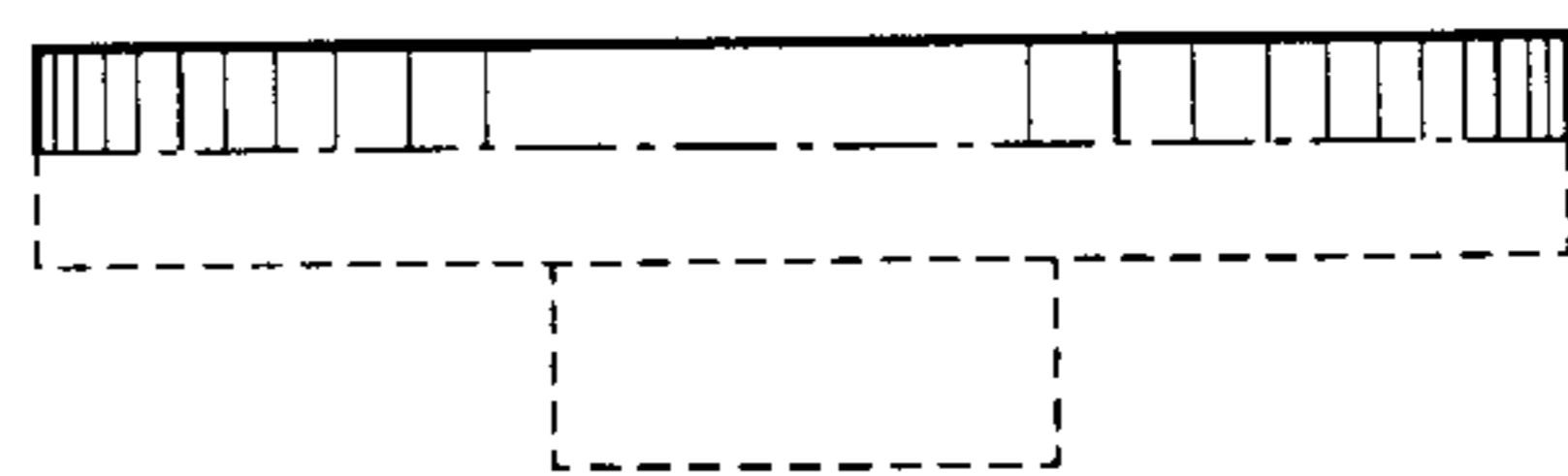

FIG. 14

