



US00D472437S

(12) **United States Design Patent**
Scola et al.

(10) **Patent No.:** **US D472,437 S**

(45) **Date of Patent:** **** Apr. 1, 2003**

(54) **STAPLER COMBINED WITH A BASE**

(75) Inventors: **Michael J. Scola**, Roselle, IL (US);
Steven C. Slowik, Wheeling, IL (US);
Anthony Jairam, Sunrise, FL (US);
John Chap, Lemont, IL (US)

(73) Assignee: **Acco Brands, Inc.**, Lincolnshire, IL (US)

(**) Term: **14 Years**

(21) Appl. No.: **29/155,856**

(22) Filed: **Feb. 19, 2002**

(51) **LOC (7) Cl.** **19-02**

(52) **U.S. Cl.** **D8/50**

(58) **Field of Search** D8/49, 50, 61;
D19/72; 227/120, 127, 128, 131, 132, 134,
156

(56) **References Cited**

U.S. PATENT DOCUMENTS

5,222,645	A	6/1993	Sueda	227/7
D387,646	S	* 12/1997	Arns	D8/50
D414,091	S	* 9/1999	Rellinger	D8/50
D420,266	S	* 2/2000	Berry et al.	D8/50
D424,898	S	* 5/2000	Wilson et al.	D8/50
6,068,173	A	5/2000	Sueda	227/7
6,152,347	A	* 11/2000	Wilson et al.	227/134
D436,009	S	* 1/2001	Kuo	D8/50
D446,430	S	* 8/2001	Arns	D8/50

OTHER PUBLICATIONS

Prior art electric staplers: Acco Brands Fact Book 2001 Catalog, pp. 188–189.

* cited by examiner

Primary Examiner—Adir Aronovich

(74) *Attorney, Agent, or Firm*—Michael Best & Friedrich LLP

(57) **CLAIM**

The ornamental design for a stapler combined with a base, as shown and described.

DESCRIPTION

FIG. 1 is a perspective view of a stapler embodying the present invention.

FIG. 2 is a top view of the stapler.

FIG. 3 is a side view of the stapler.

FIG. 4 is a front view of the stapler.

FIG. 5 is a rear view of the stapler.

FIG. 6 is a perspective view of the stapler received in a base.

FIG. 7 is a top view of the stapler received in the base.

FIG. 8 is a side view of the stapler received in the base.

FIG. 9 is a front view of the stapler received in the base; and,

FIG. 10 is a rear view of the stapler received in the base.

The claimed design is embodied in the combined appearance of a stapler and a base. The stapler is shown separately in FIGS. 1–5 in order to disclose aspects of the design that are not apparent from the views showing the assembled members.

The portions of the stapler and the base shown in broken lines are for illustrative purposes only and form no part of the claimed design. The side view opposite FIG. 3 is a mirror image of FIG. 3 and is not shown. The side view opposite FIG. 8 is a mirror image of FIG. 8 and is not shown.

1 Claim, 7 Drawing Sheets

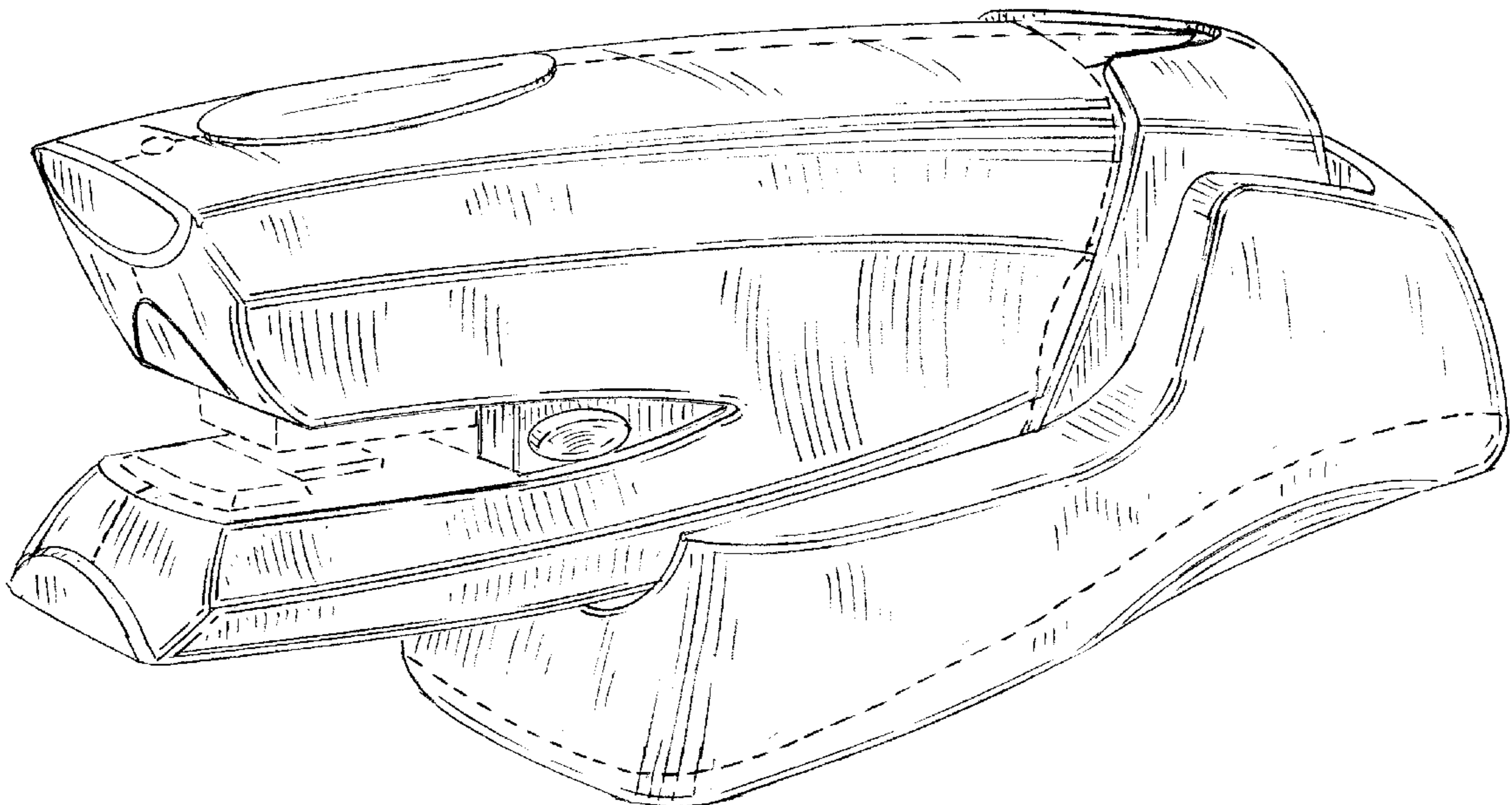

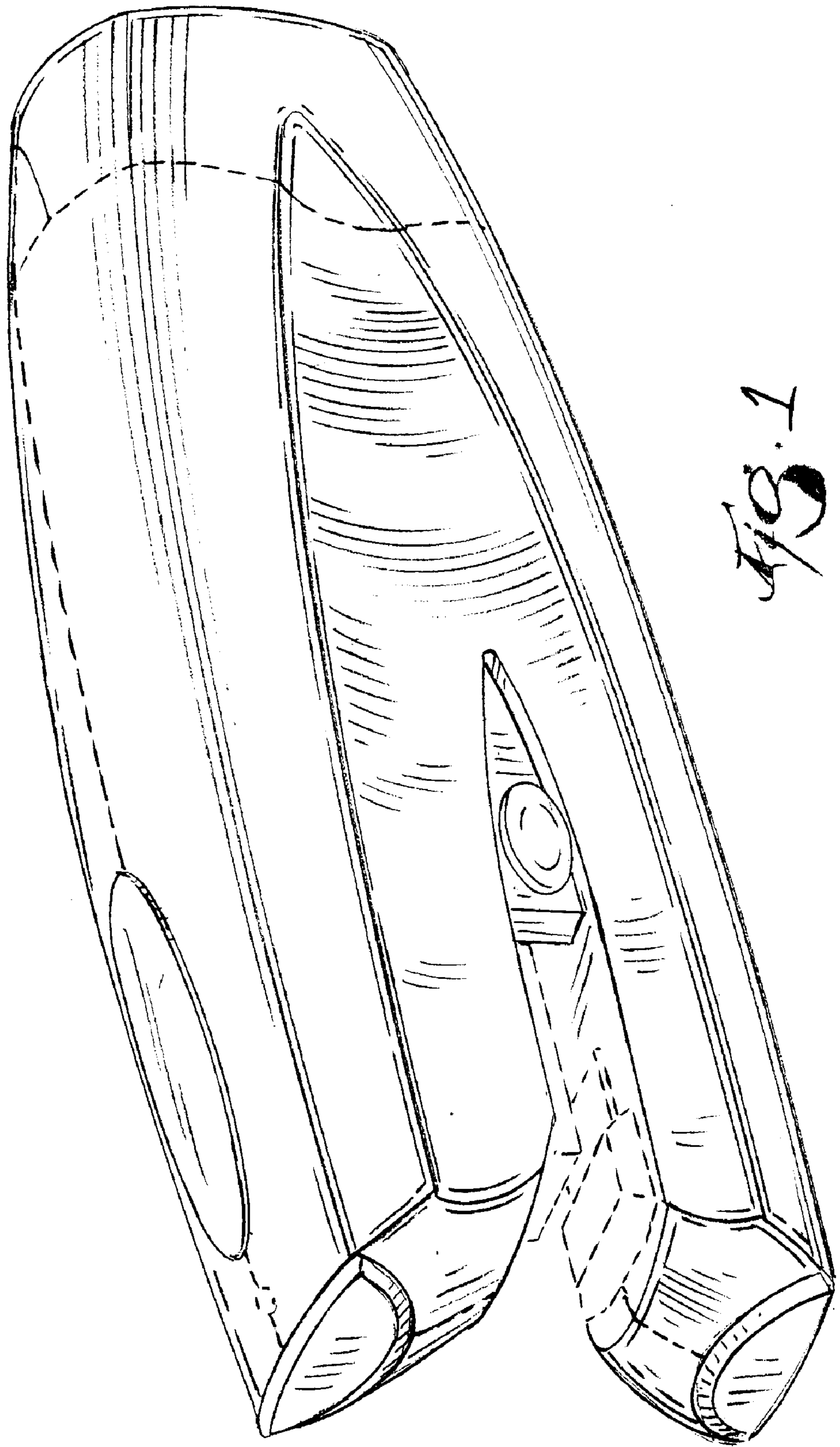

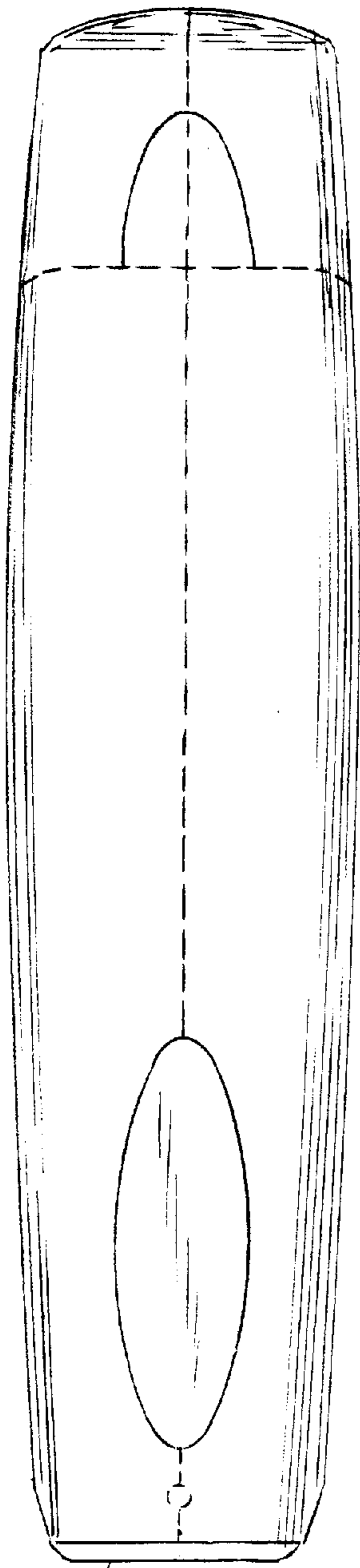

FIG. 2

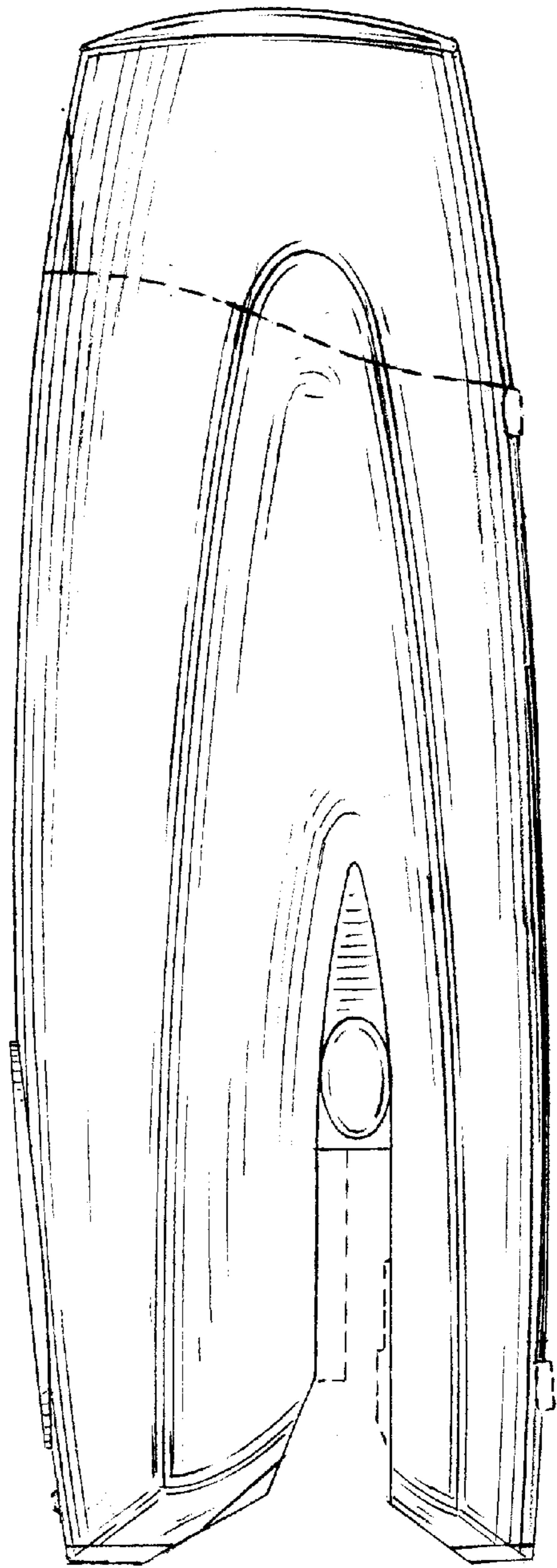

FIG. 3

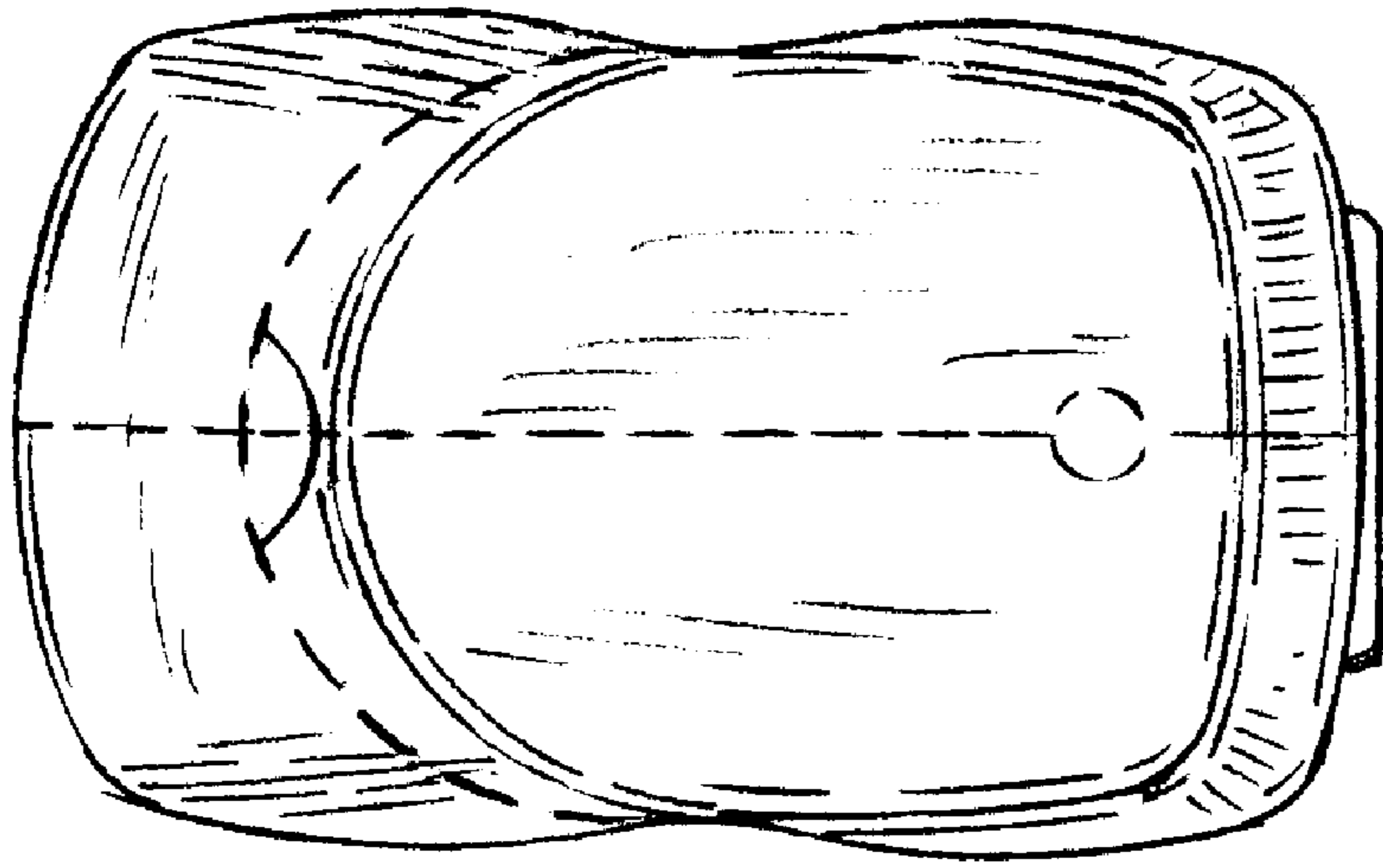

FIG. 5

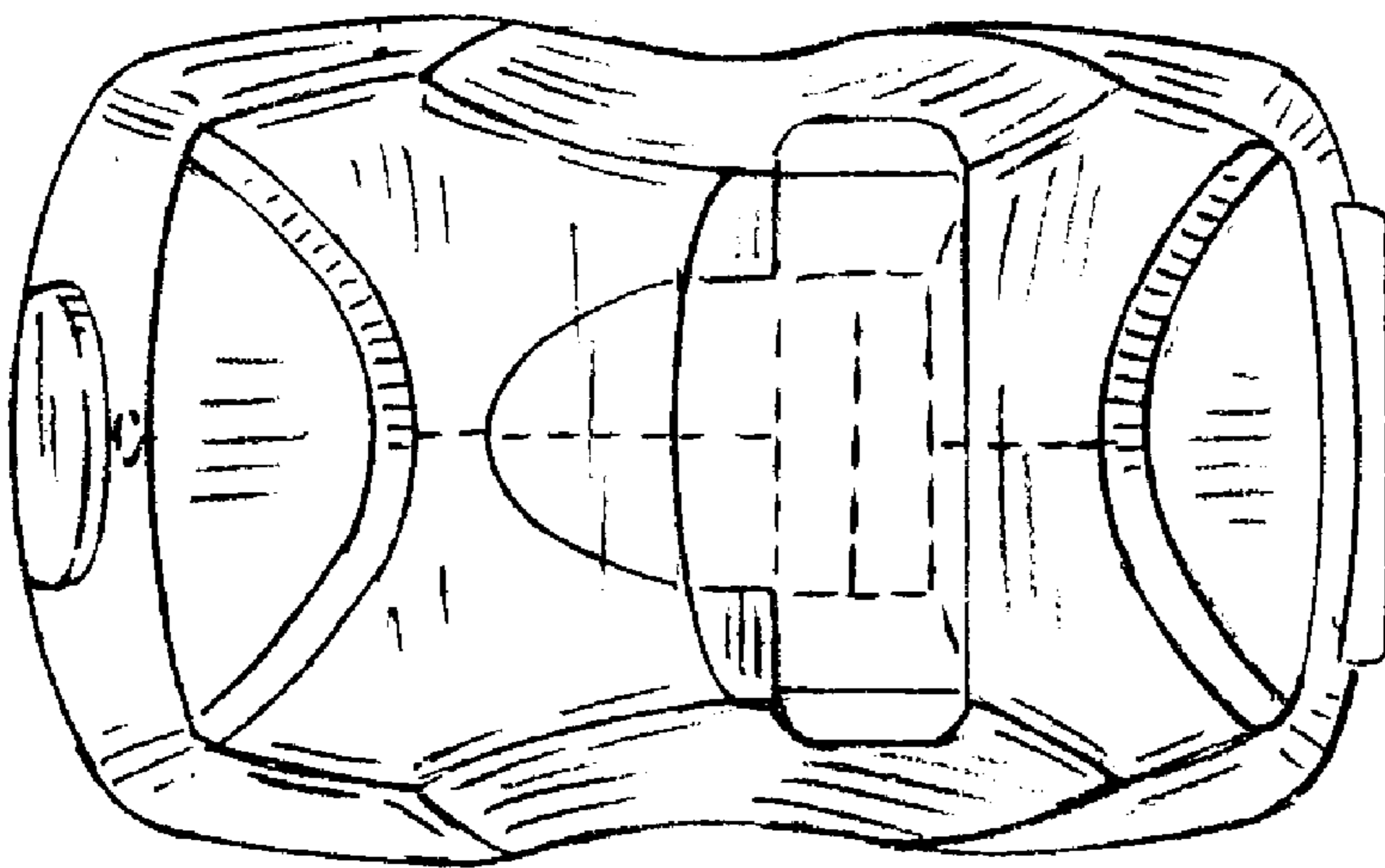

FIG. 4

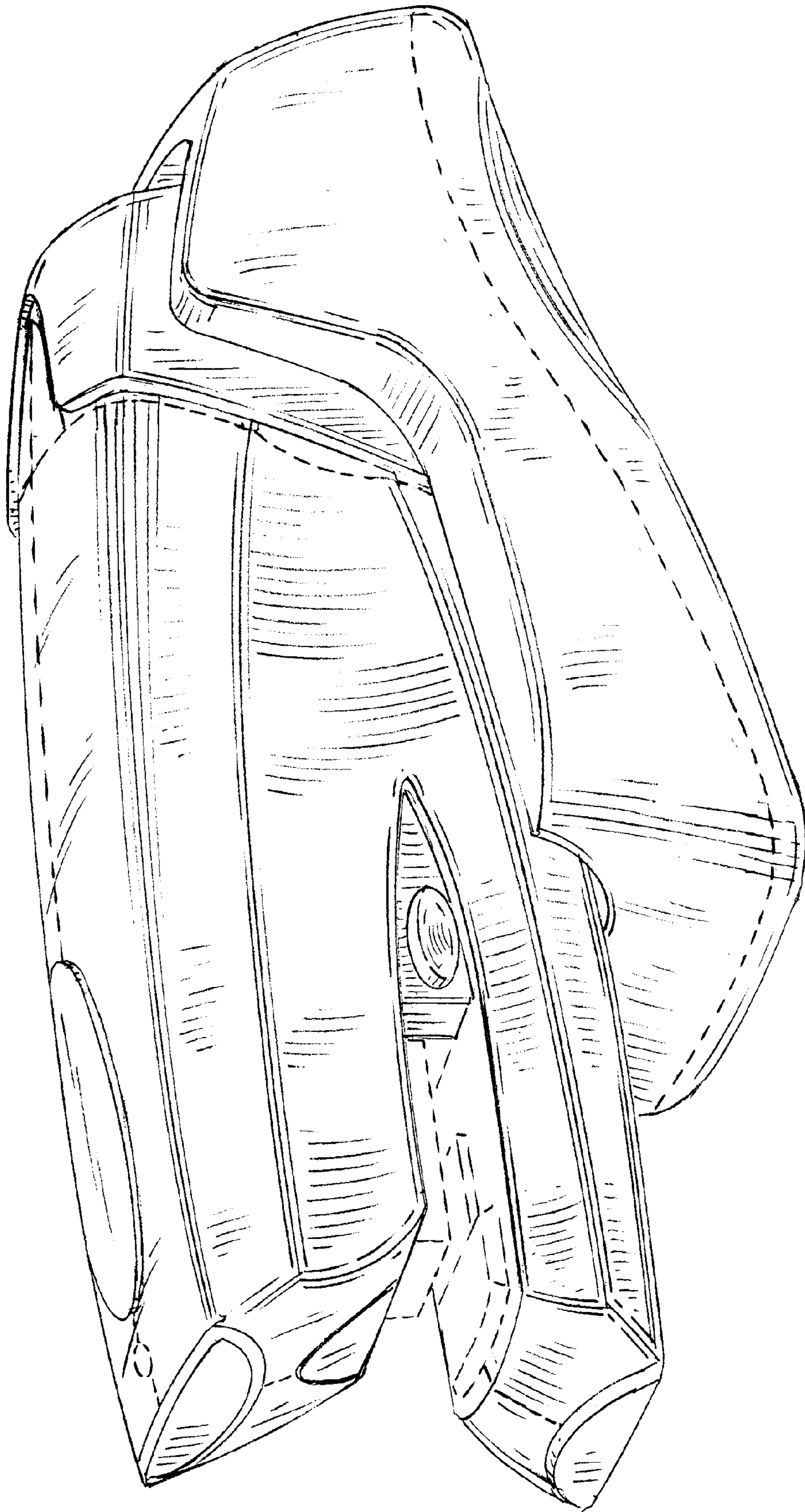

FIG. 6

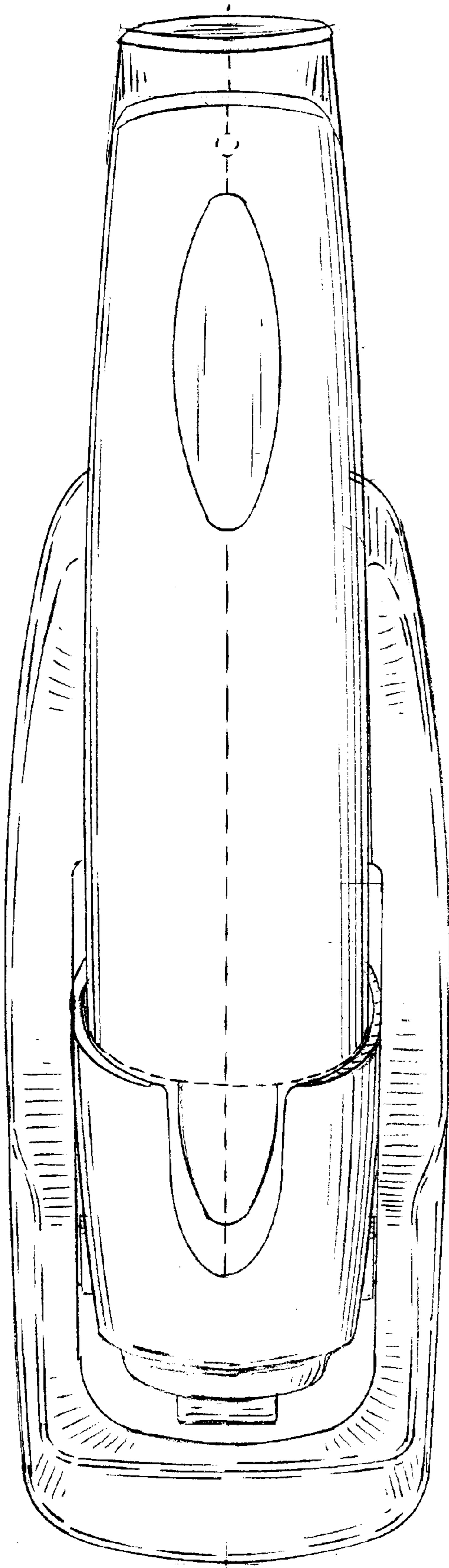

Fig. 7

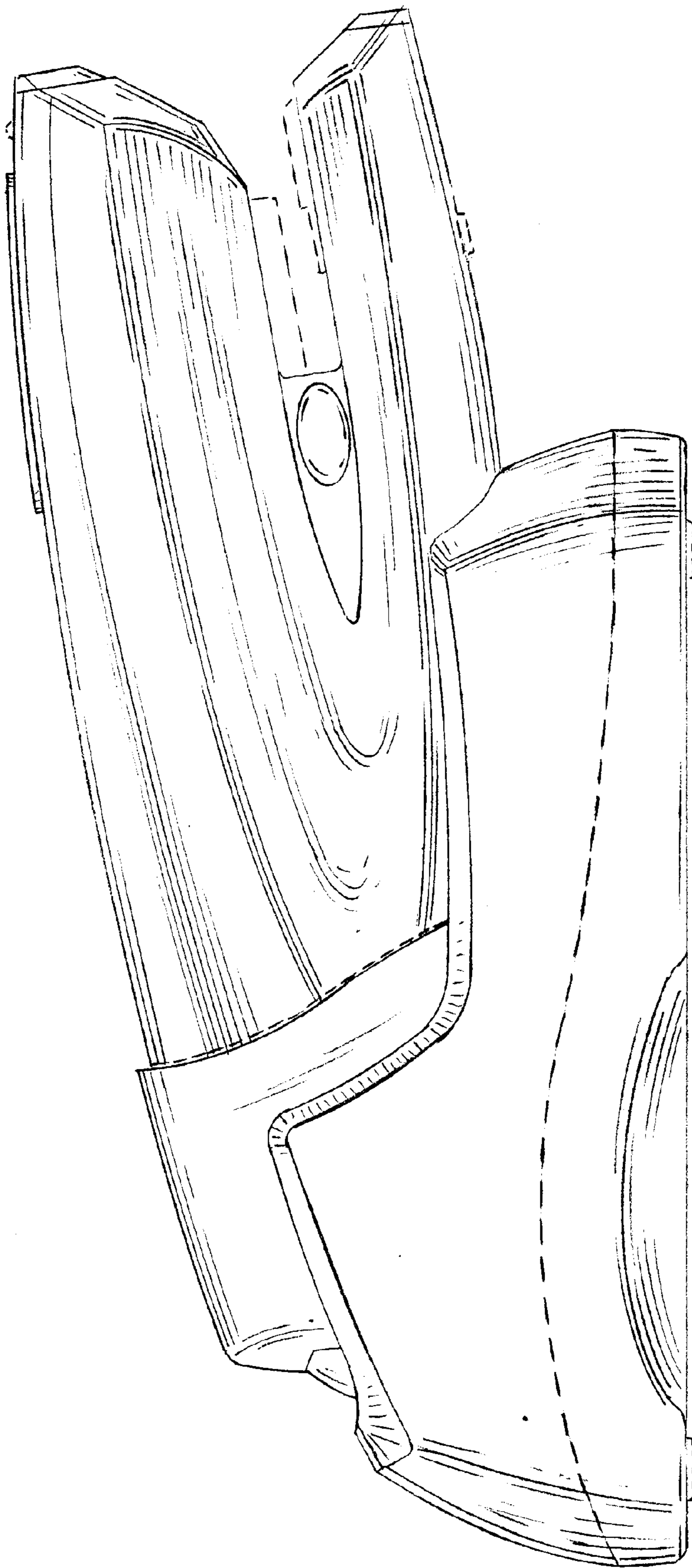

FIG. 8

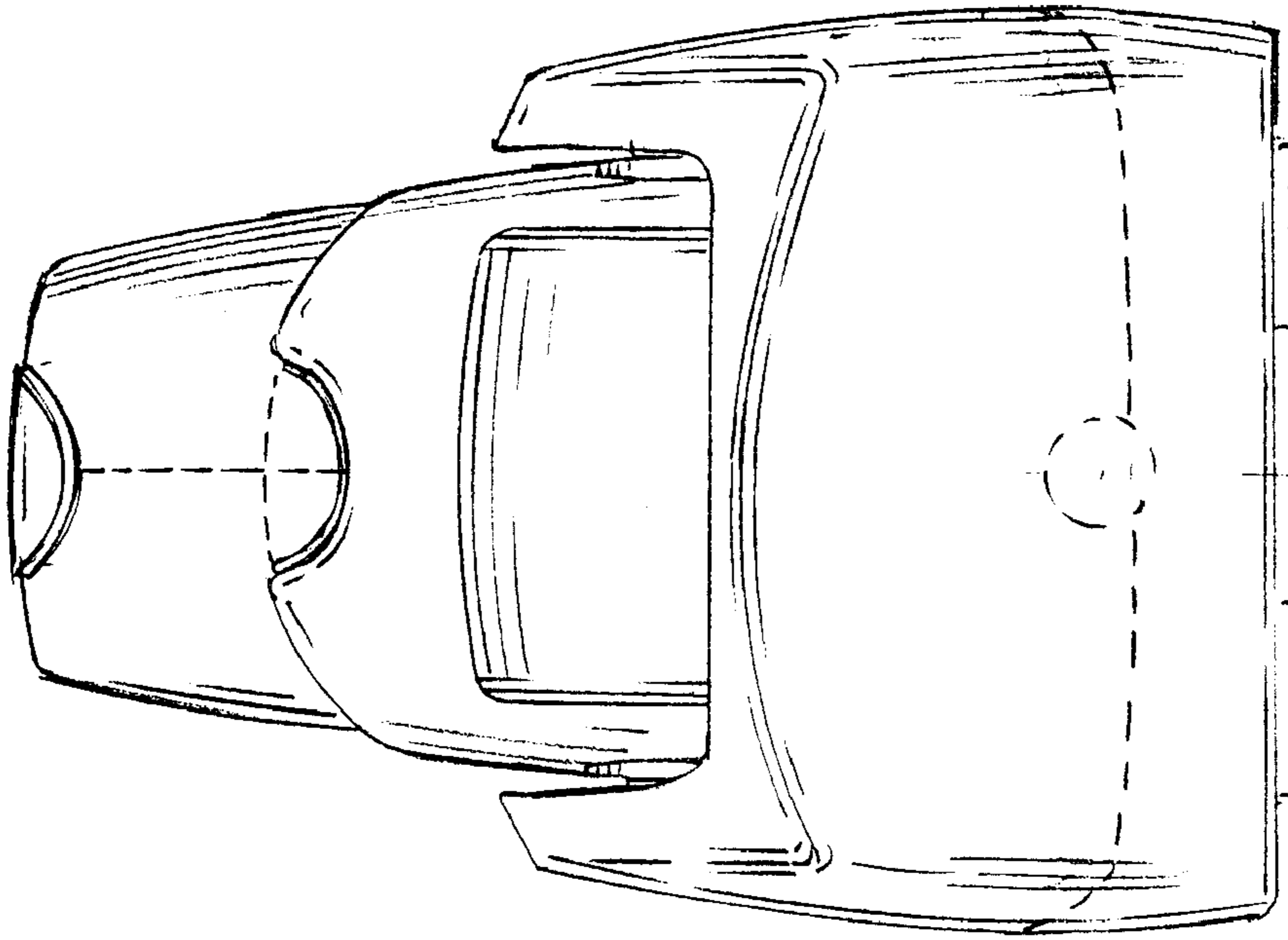

FIG. 10

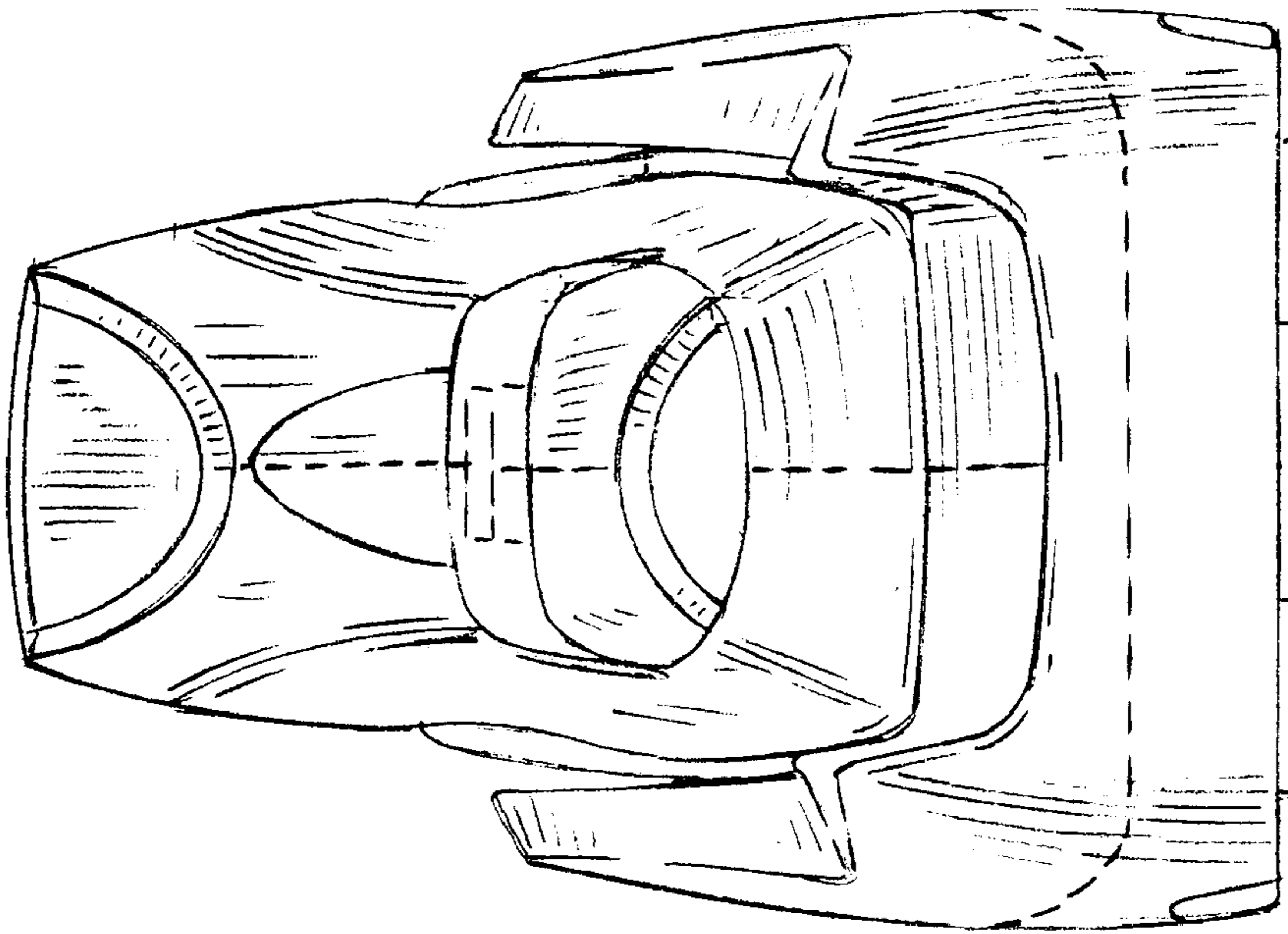

FIG. 9

UNITED STATES PATENT AND TRADEMARK OFFICE
CERTIFICATE OF CORRECTION

PATENT NO. : Des. 472,437 S
DATED : April 1, 2003
INVENTOR(S) : Michael J. Scola et al.

Page 1 of 9

It is certified that error appears in the above-identified patent and that said Letters Patent is hereby corrected as shown below:

The title page should be deleted to appear as per attached title page.

The sheets of drawings consisting of figures 1-7 should be deleted to appear as per attached figures 1-7.

Signed and Sealed this

Seventh Day of October, 2003

A handwritten signature in black ink, appearing to read "James E. Rogan", with a horizontal line drawn underneath it.

JAMES E. ROGAN
Director of the United States Patent and Trademark Office

(12) **United States Design Patent** (10) **Patent No.:** **US D472,437 S**
Scola et al. (45) **Date of Patent:** **** Apr. 1, 2003**

(54) **STAPLER COMBINED WITH A BASE**
 (75) Inventors: **Michael J. Scola, Roselle, IL (US);**
Steven C. Slowik, Wheeling, IL (US);
Anthony Jairam, Sunrise, FL (US);
John Chap, Lemont, IL (US)

(73) Assignee: **Acco Brands, Inc., Lincolnshire, IL (US)**

(**) Term: **14 Years**

(21) Appl. No.: **29/155,856**

(22) Filed: **Feb. 19, 2002**

(51) **LOC (7) Cl.** **19-02**
 (52) **U.S. Cl.** **D8/50**
 (58) **Field of Search** **D8/49, 50, 61;**
D19/72; 227/120, 127, 128, 131, 132, 134,
156

(56) **References Cited**

U.S. PATENT DOCUMENTS

5,222,645 A	6/1993	Sueda	227/7
D387,646 S	* 12/1997	Arns	D8/50
D414,091 S	* 9/1999	Rellinger	D8/50
D420,266 S	* 2/2000	Berry et al.	D8/50
D424,898 S	* 5/2000	Wilson et al.	D8/50
6,068,173 A	5/2000	Sueda	227/7
6,152,347 A	* 11/2000	Wilson et al.	227/134
D436,009 S	* 1/2001	Kuo	D8/50
D446,430 S	* 8/2001	Arns	D8/50

OTHER PUBLICATIONS

Prior art electric staplers: Acco Brands Fact Book 2001 Catalog, pp. 188-189.

* cited by examiner

Primary Examiner—Adir Aronovich
 (74) *Attorney, Agent, or Firm*—Michael Best & Friedrich LLP

(57) **CLAIM**

The ornamental design for a stapler combined with a base, as shown and described.

DESCRIPTION

FIG. 1 is a perspective view of a stapler embodying the present invention.
 FIG. 2 is a top view of the stapler.
 FIG. 3 is a side view of the stapler.
 FIG. 4 is a front view of the stapler.
 FIG. 5 is a rear view of the stapler.
 FIG. 6 is a perspective view of the stapler received in a base.
 FIG. 7 is a top view of the stapler received in the base.
 FIG. 8 is a side view of the stapler received in the base.
 FIG. 9 is a front view of the stapler received in the base; and,
 FIG. 10 is a rear view of the stapler received in the base.

The claimed design is embodied in the combined appearance of a stapler and a base. The stapler is shown separately in FIGS. 1-5 in order to disclose aspects of the design that are not apparent from the views showing the assembled members.

The portions of the stapler and the base shown in broken lines are for illustrative purposes only and form no part of the claimed design. The side view opposite FIG. 3 is a mirror image of FIG. 3 and is not shown. The side view opposite FIG. 8 is a mirror image of FIG. 8 and is not shown.

1 Claim, 7 Drawing Sheets

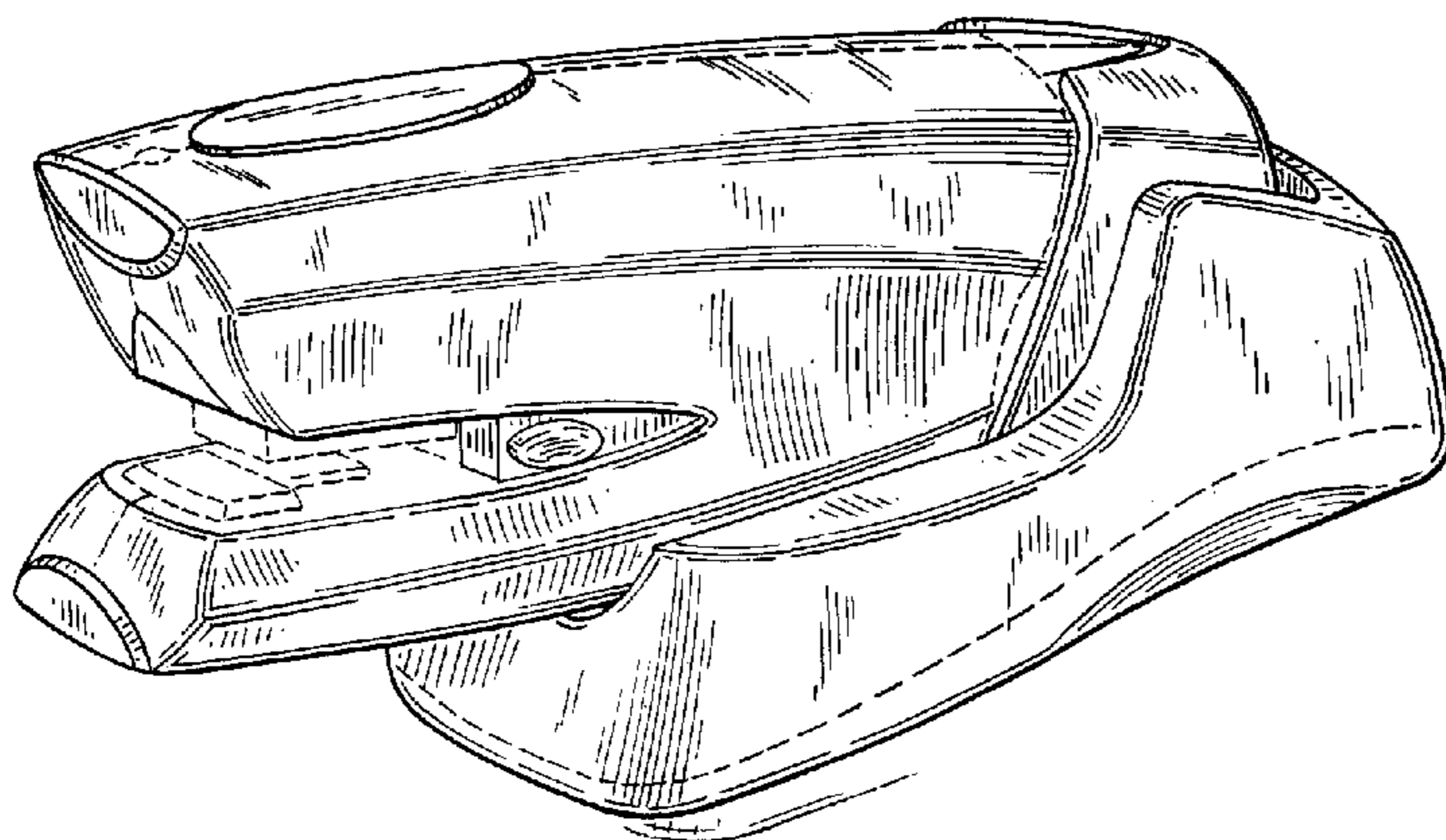

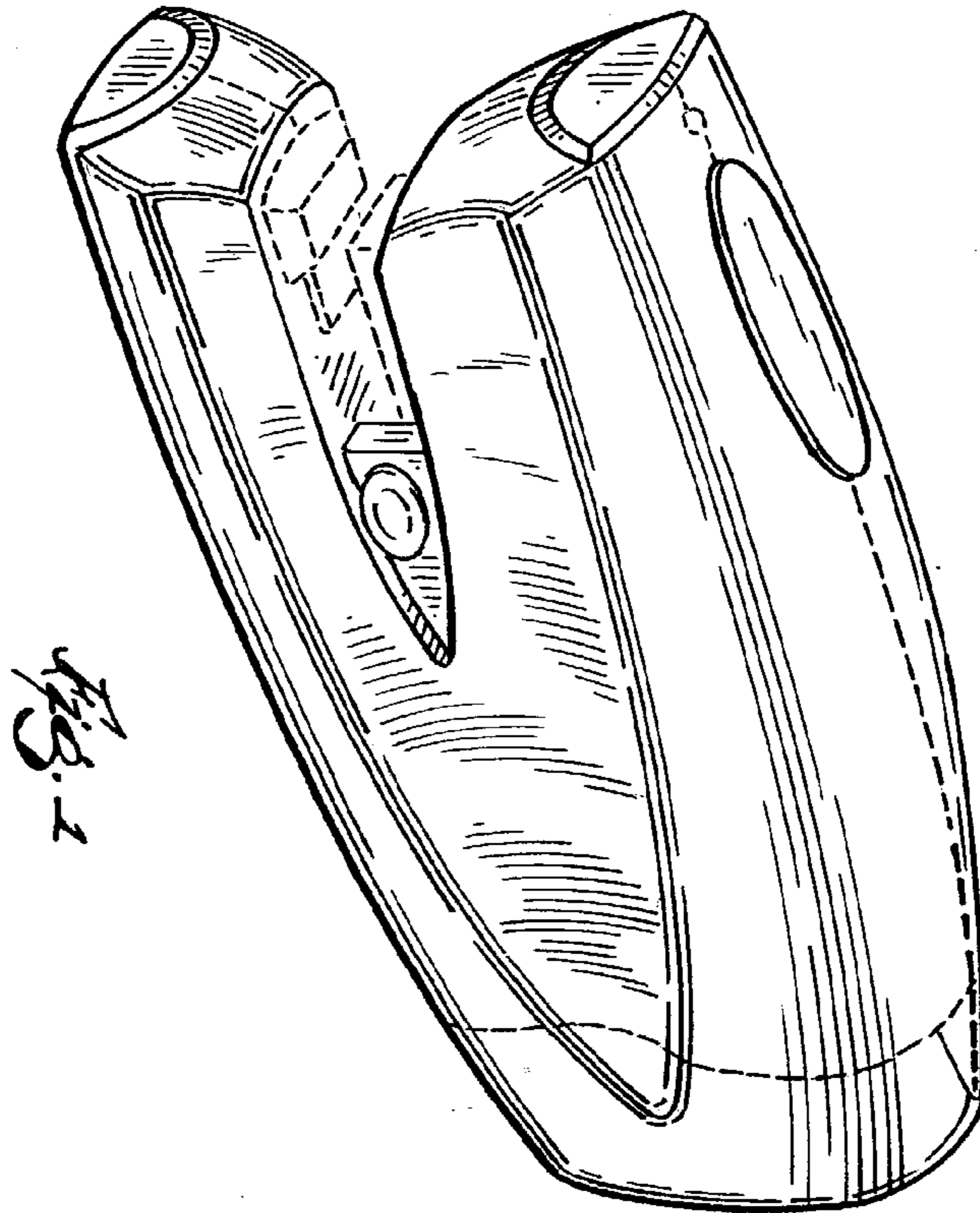

Fig. 3

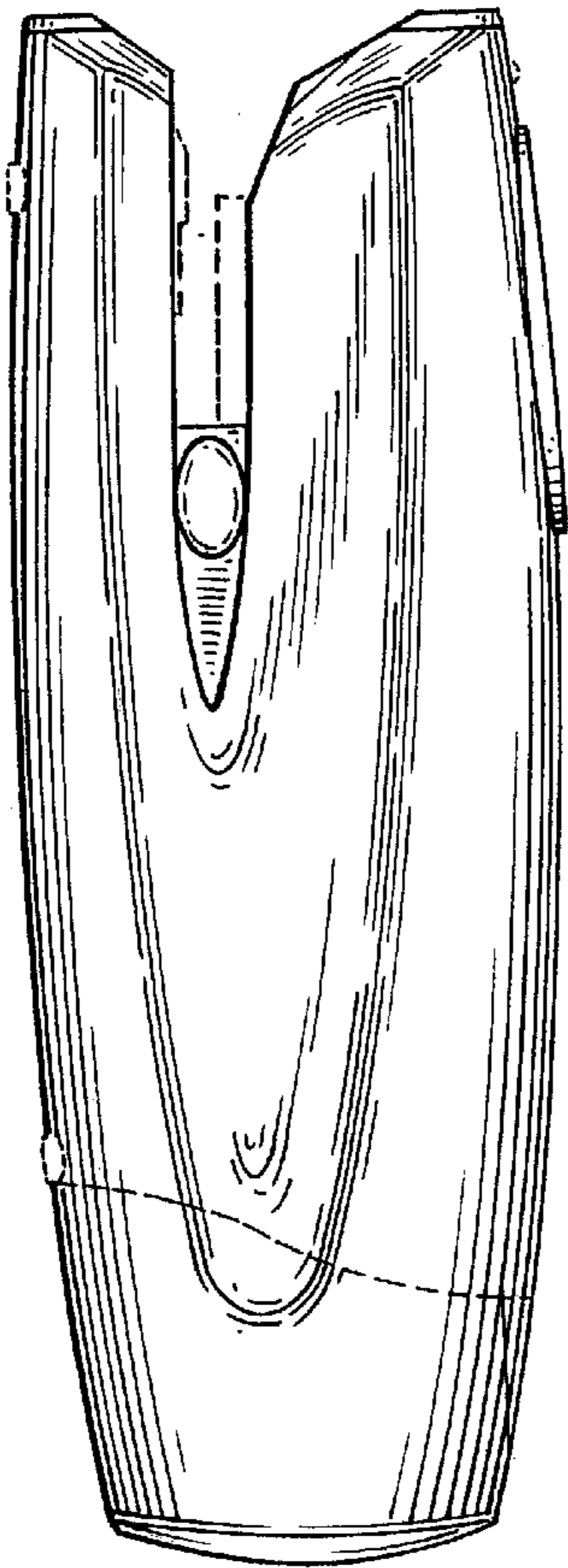

Fig. 2

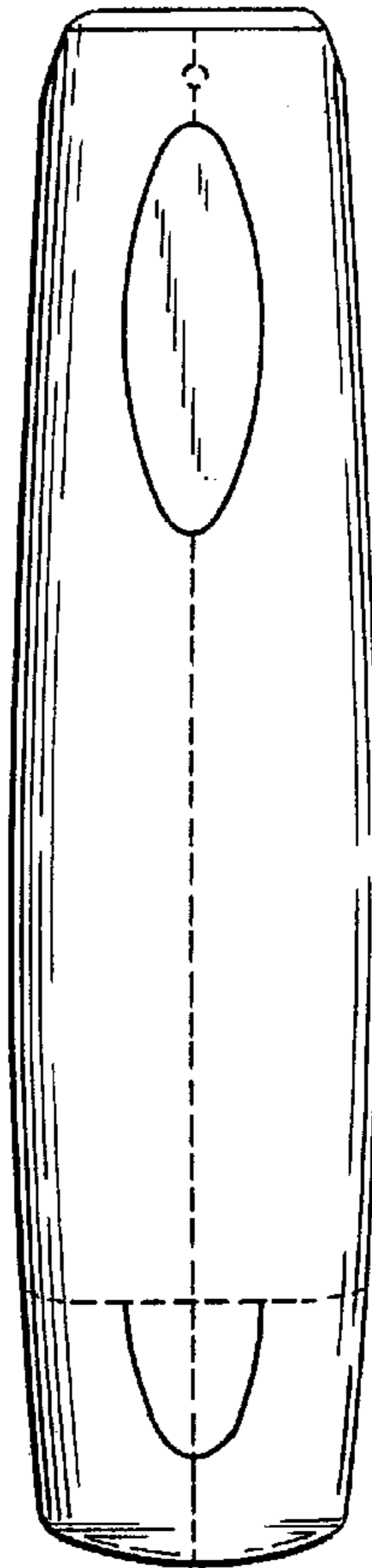

Fig. 4

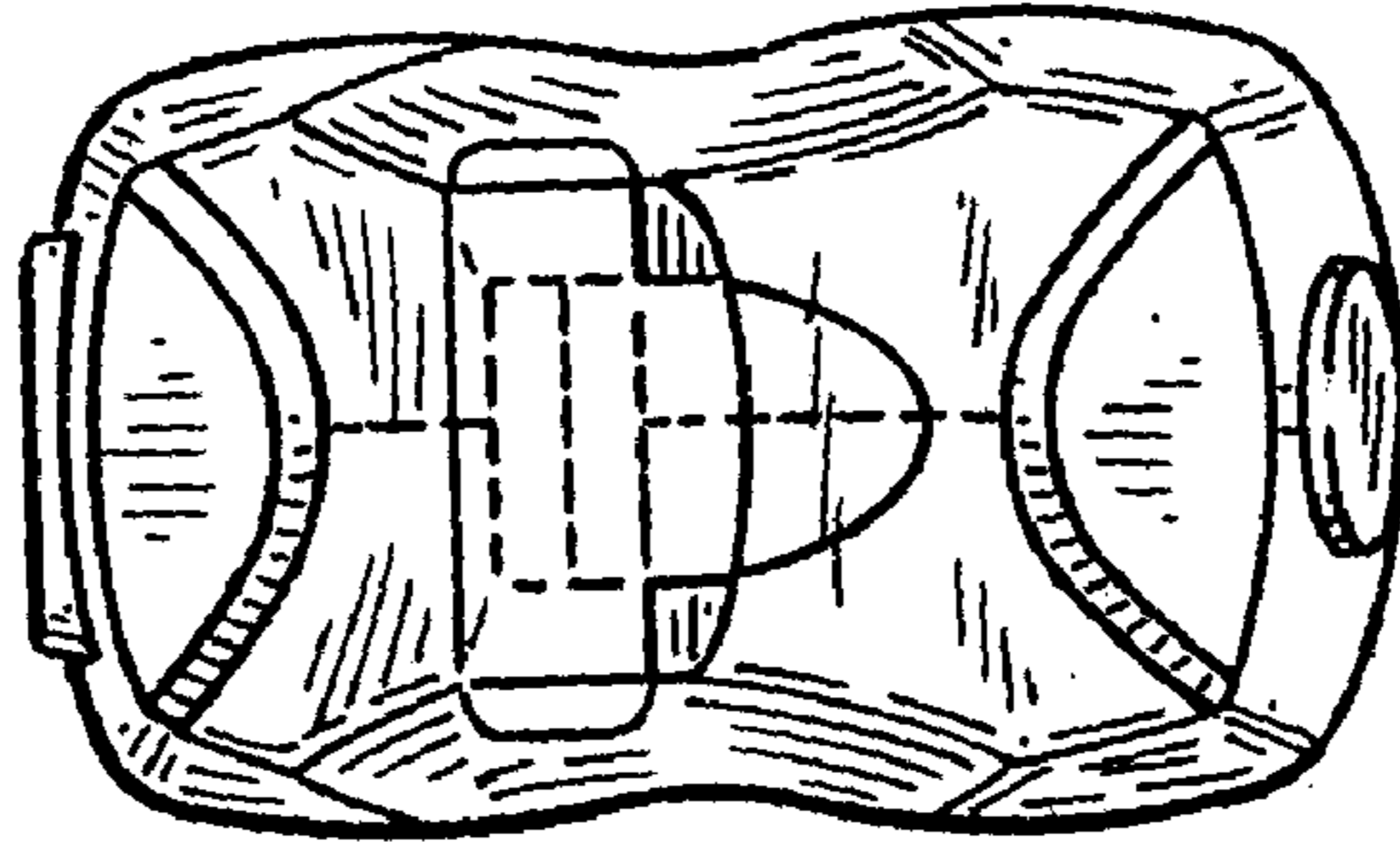
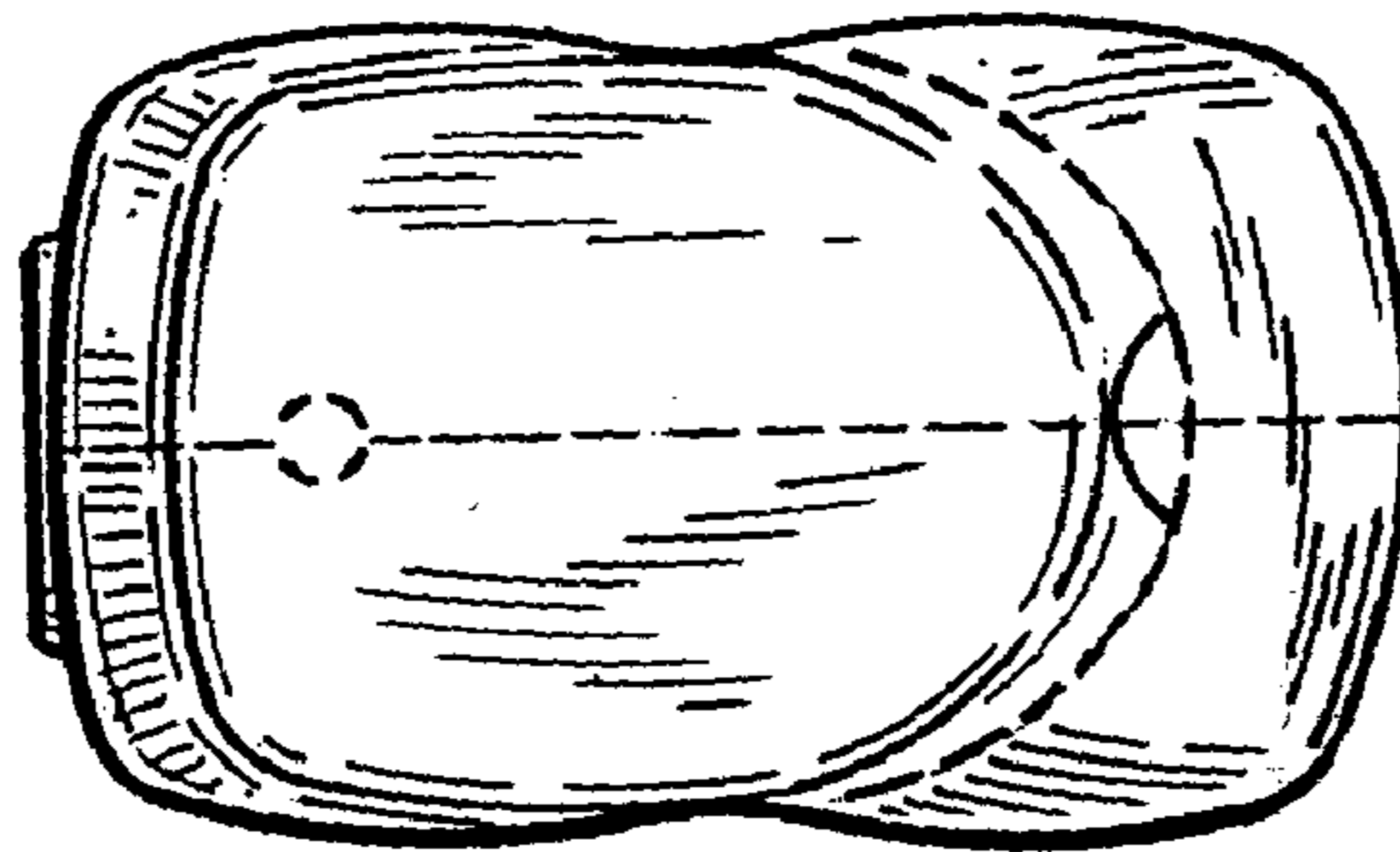

Fig. 5



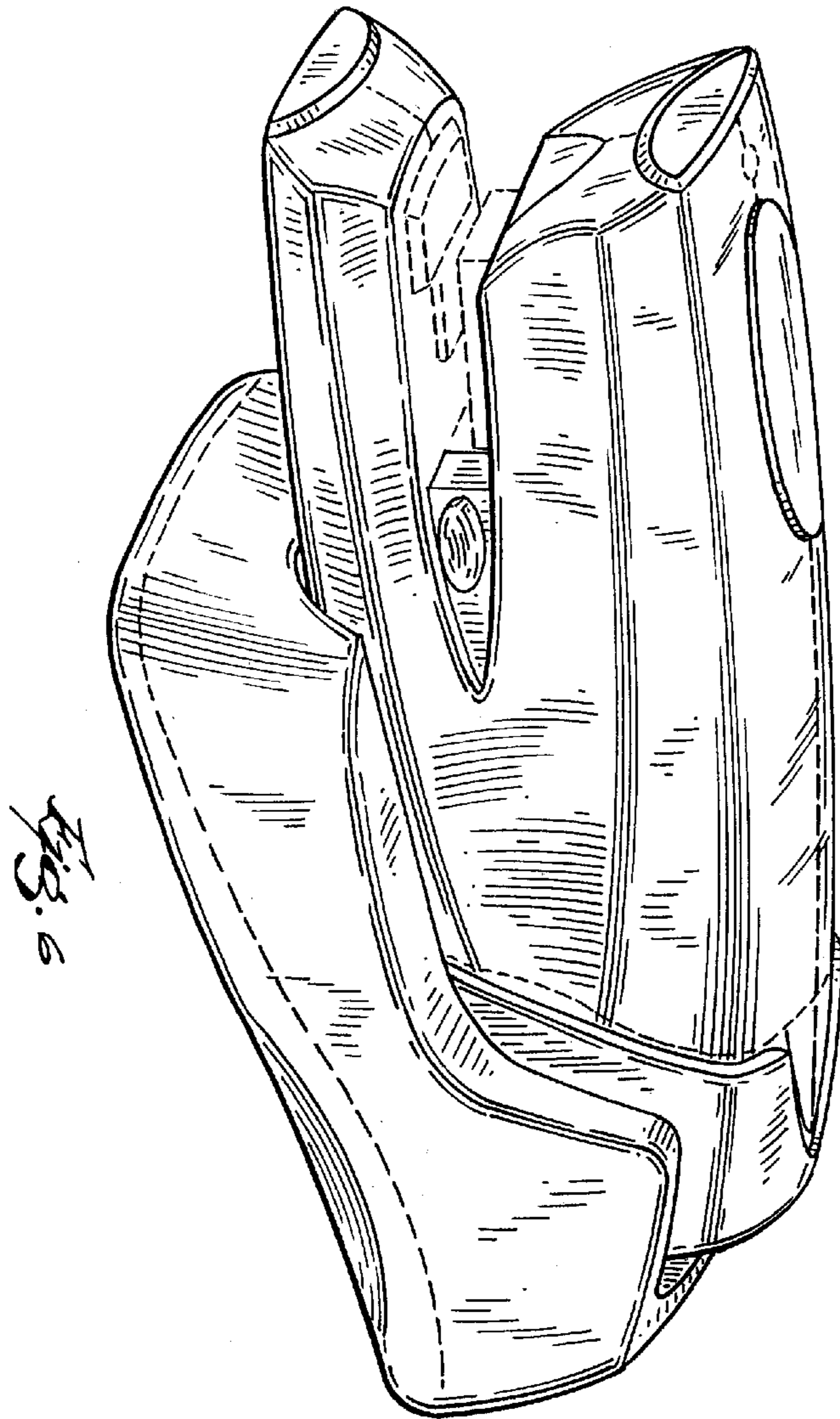
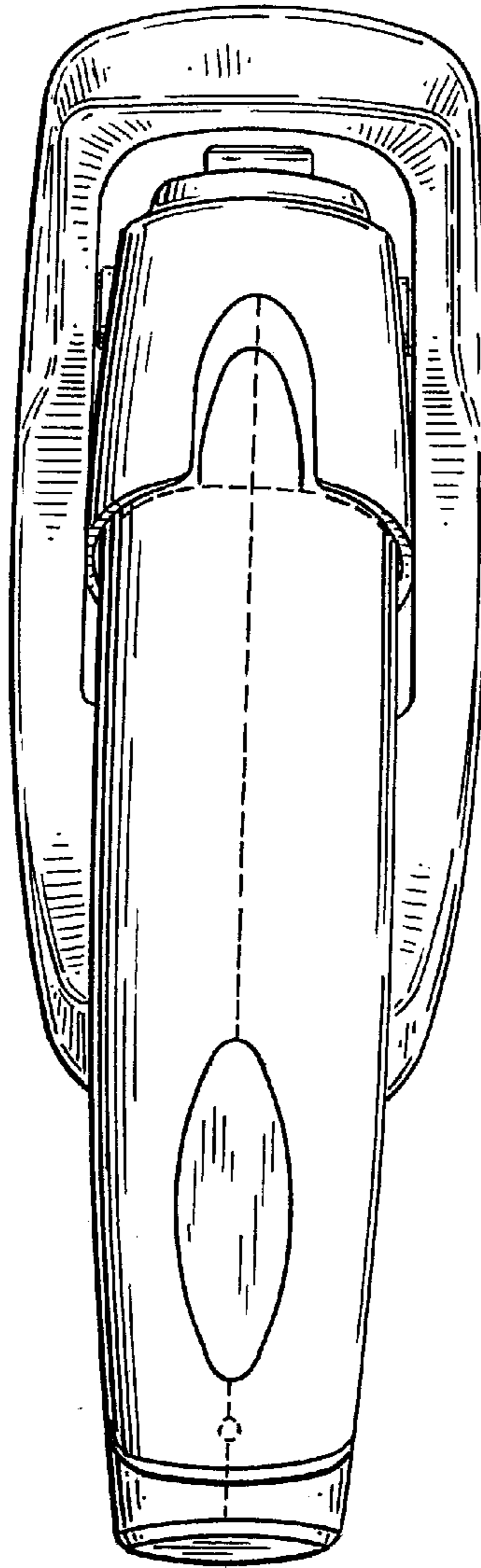

FIG. 1



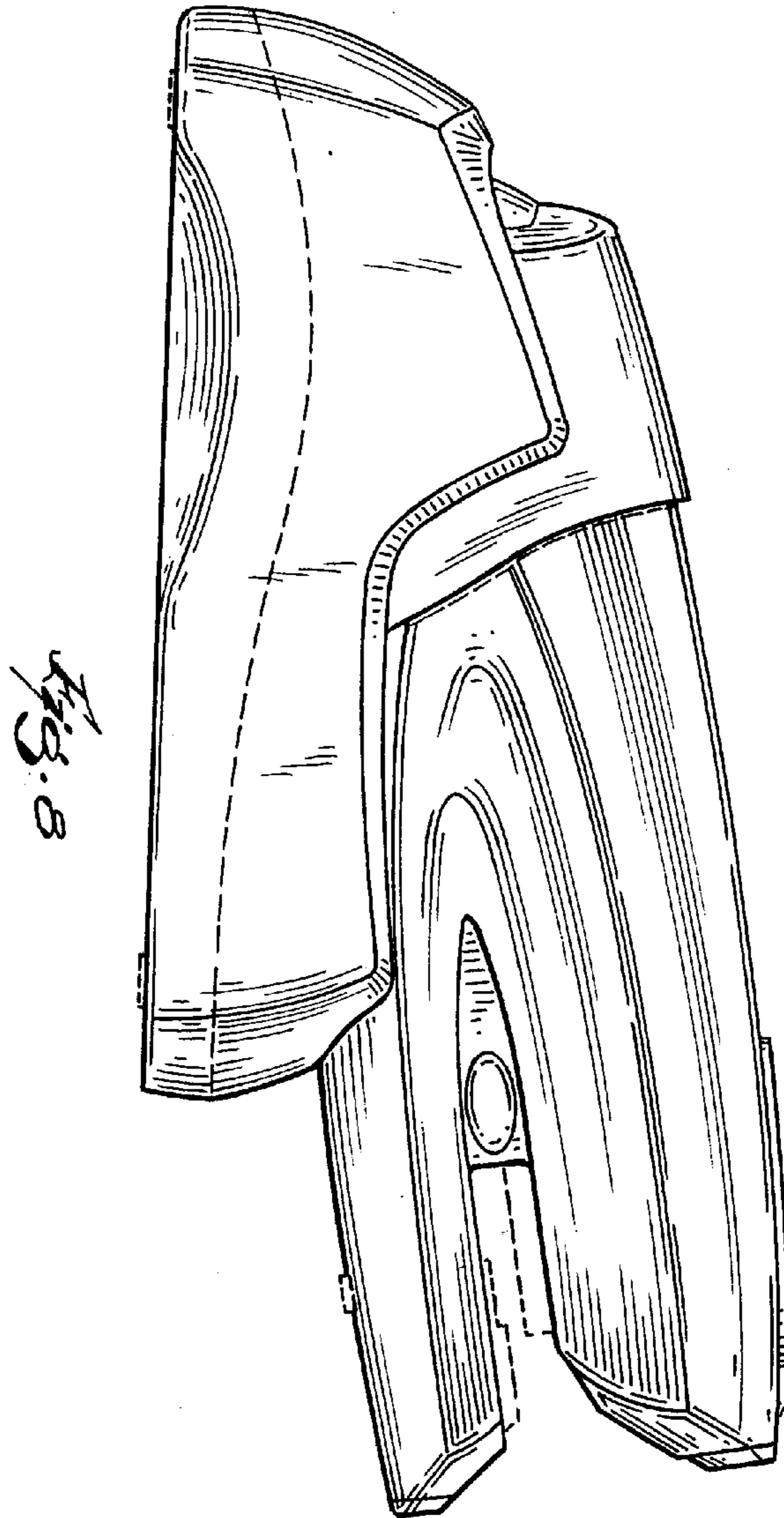

FIG. 9

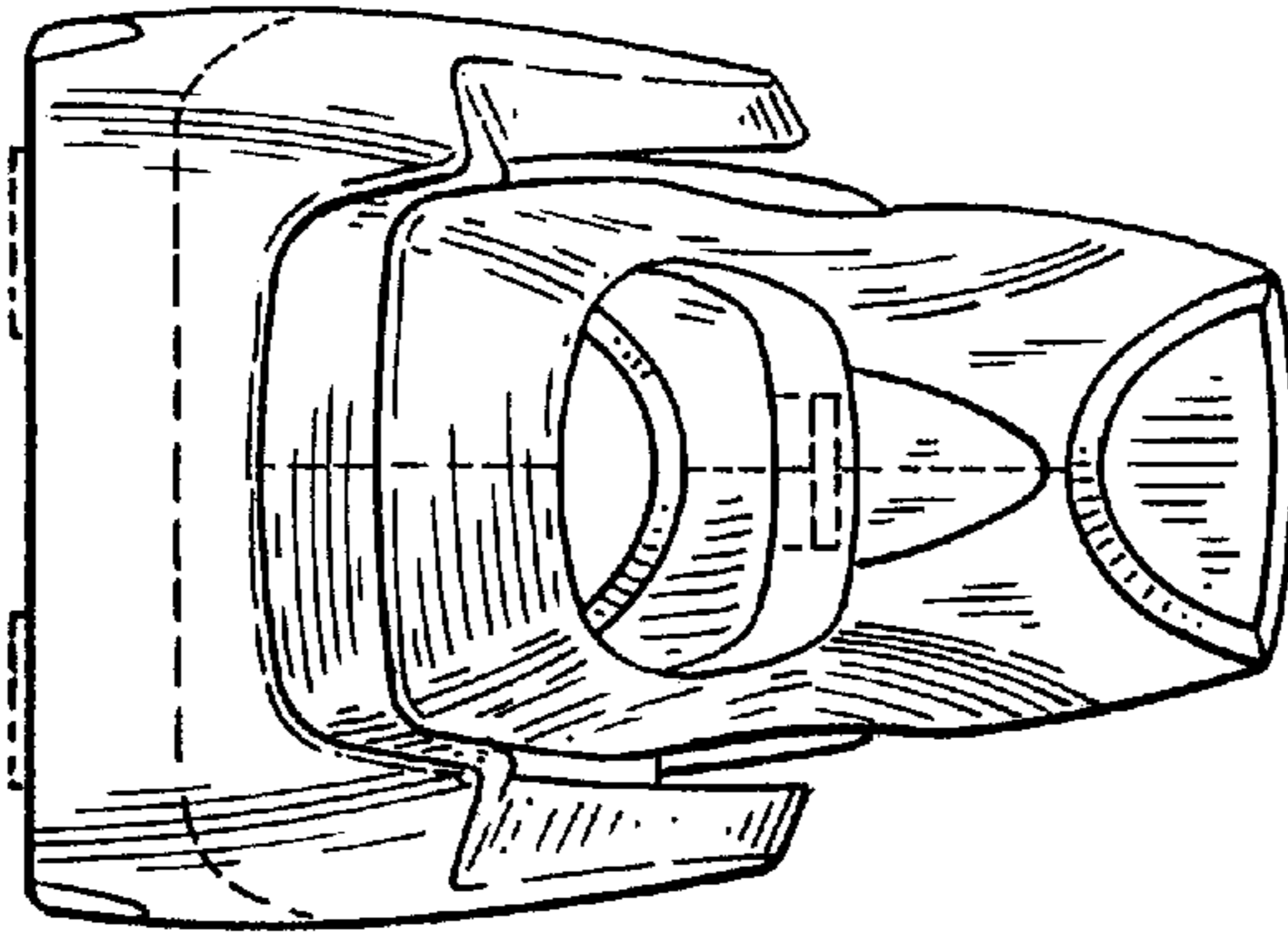

FIG. 10

