



US00D472375S

(12) **United States Design Patent**
Stokes

(10) **Patent No.:** **US D472,375 S**

(45) **Date of Patent:** **** Apr. 1, 2003**

(54) **COMBINATION GOLF BAG AND TRAVEL CASE WITH PARTITIONS**

(76) **Inventor:** **Richard B. Stokes**, 12 Farview Dr., Anandale, NJ (US) 08801

(**) **Term:** **14 Years**

(21) **Appl. No.:** **29/153,334**

(22) **Filed:** **Jan. 3, 2002**

(51) **LOC (7) Cl.** **03-01**

(52) **U.S. Cl.** **D3/255**

(58) **Field of Search** D3/254, 255, 273, D3/276; 206/315.2, 315.3, 315.4, 315.5, 315.6, 315.7, 315.8

(56) **References Cited**

U.S. PATENT DOCUMENTS

5,002,185	A	*	3/1991	Schurman	206/315.3
D323,427	S	*	1/1992	Schurman	D3/255
D349,402	S	*	8/1994	Fiore	D3/255
D360,296	S	*	7/1995	Hunsaker	D3/255
D375,405	S	*	11/1996	Hunsaker	D3/255
D394,950	S	*	6/1998	Kite	D3/255
D414,035	S		9/1999	Stokes	D3/255
D421,838	S	*	3/2000	Bradshaw et al.	D3/255
D436,440	S		1/2001	Stokes	D3/255

* cited by examiner

Primary Examiner—Philip S. Hyder

(74) *Attorney, Agent, or Firm*—Greenwald & Basch LLP;; Duane C. Basch

(57) **CLAIM**

The ornamental design for a combination golf bag and travel case with partitions, as shown and described.

DESCRIPTION

FIG. 1 is a perspective view of the top, front and right side

of the combination golf bag and travel case, with the cover removed;

FIG. 2 is a perspective view with the shoulder strap and accessory bag removed for convenience of illustration;

FIG. 3 is a front elevation view of the case with an accessory bag shown in a dashed-line format;

FIG. 4 is a right side elevation view of the case with the accessory bag shown in a dashed-line format;

FIG. 5 is a rear elevation view of the case with the accessory bag shown in a dashed-line format;

FIG. 6 is a left side elevation view of the case with the accessory bag shown in a dashed-line format;

FIG. 7 is a top plan view of the case showing T-shaped partitions at the top thereof;

FIG. 8 is a partial perspective view of the case showing T-shaped partition supports separated from the case;

FIG. 9 is a perspective view illustrating the T-shaped supports and fabric partitions within the case and attached to a plate located at the bottom of the case, wherein the golf bag has been shown in broken line form in order to make it possible to see the partitions and bottom plate;

FIG. 10 is a right side elevation view of the cover;

FIG. 11 is a front elevation view of the cover;

FIG. 12 is a rear elevation view of the cover;

FIG. 13 is a left side elevation view of the cover;

FIG. 14 is a top plan view of the cover; and,

FIG. 15 is a view looking into the cover from below.

The bottom of the case is flat and unornamented. The broken-line showing of environment in FIGS. 1 and 3 through 7 is for illustrative purposes only and forms no part of the claimed design.

1 Claim, 8 Drawing Sheets

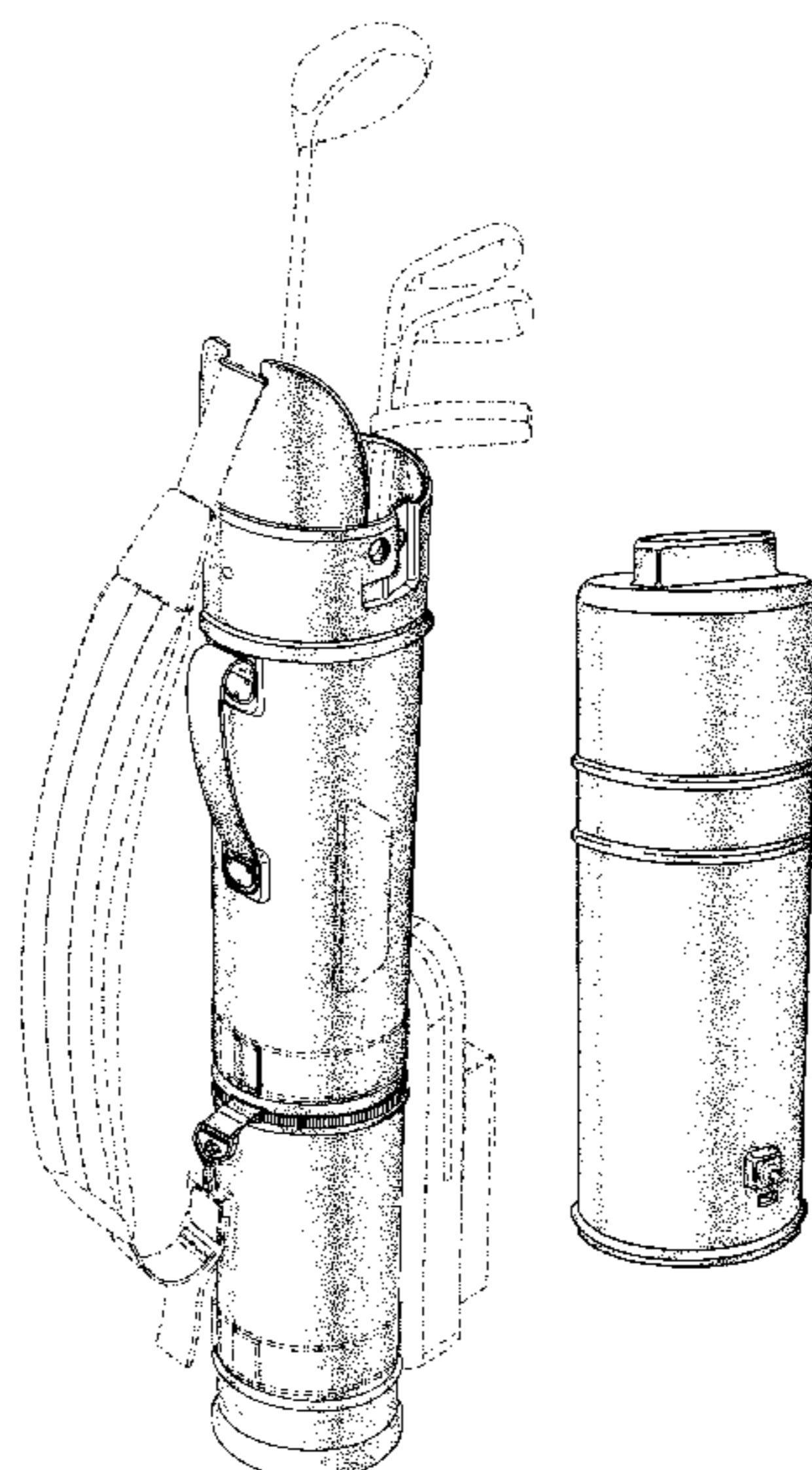

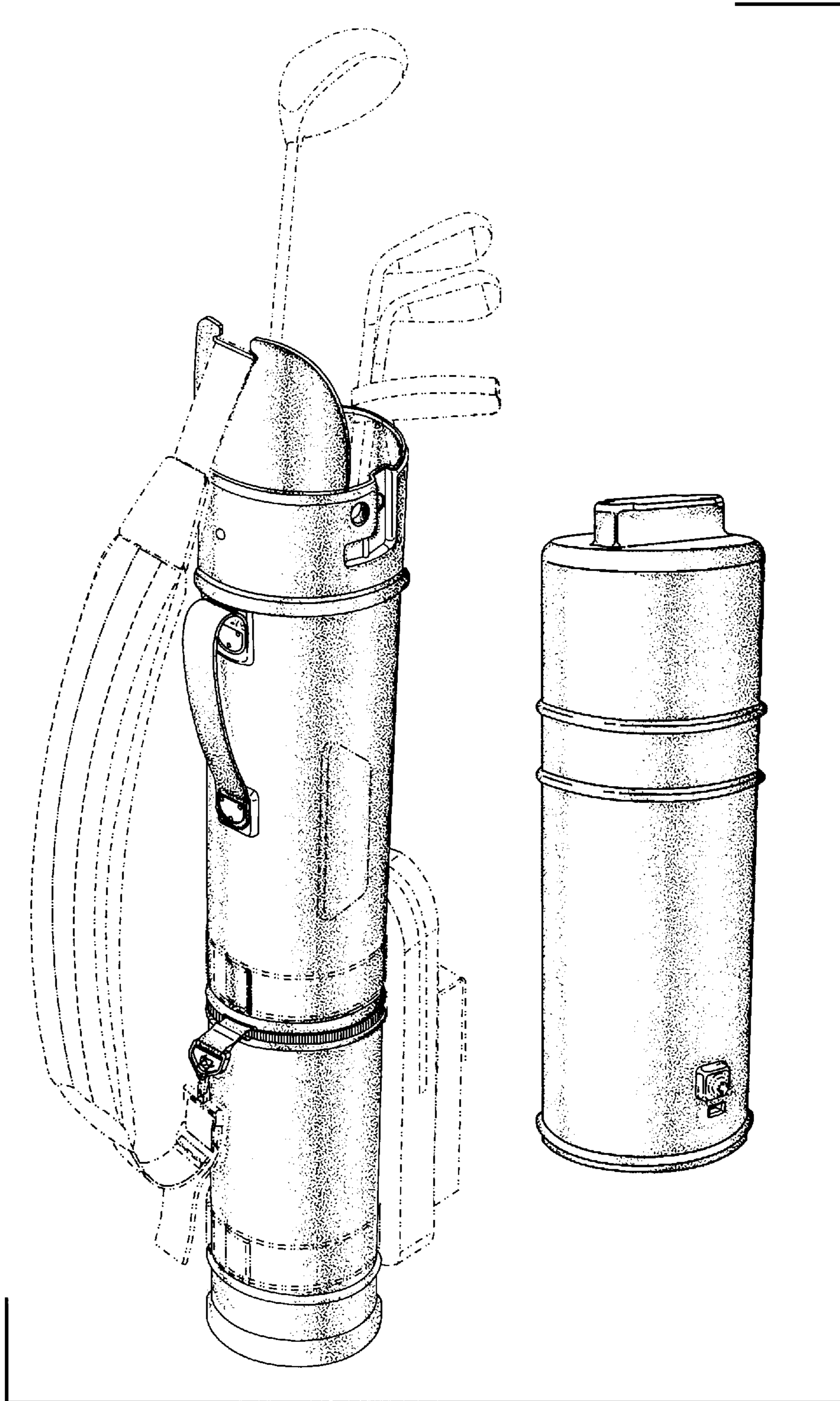

FIG. 1

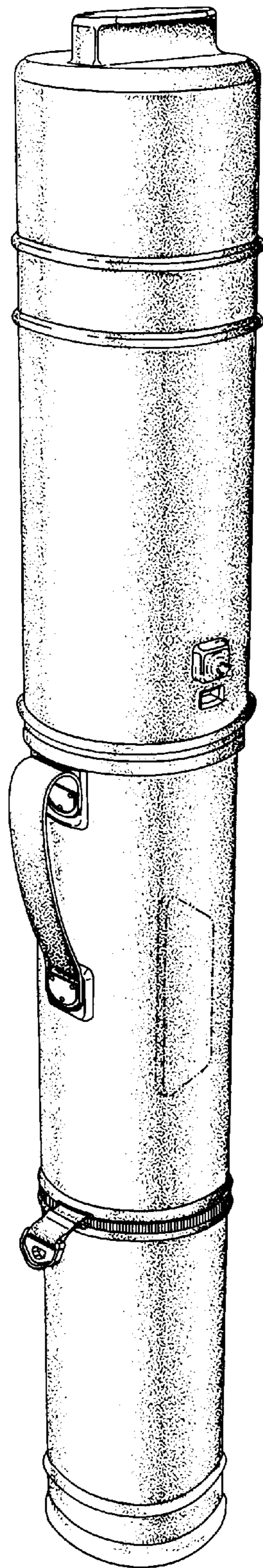

FIG. 2

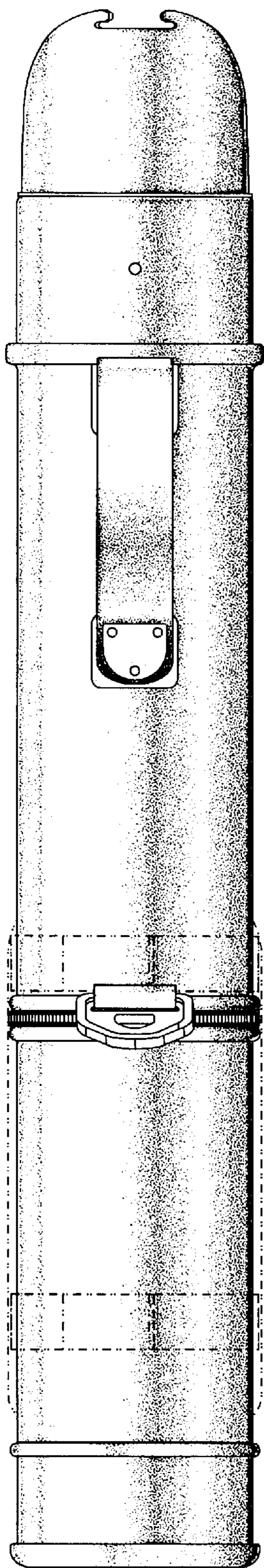

FIG. 3

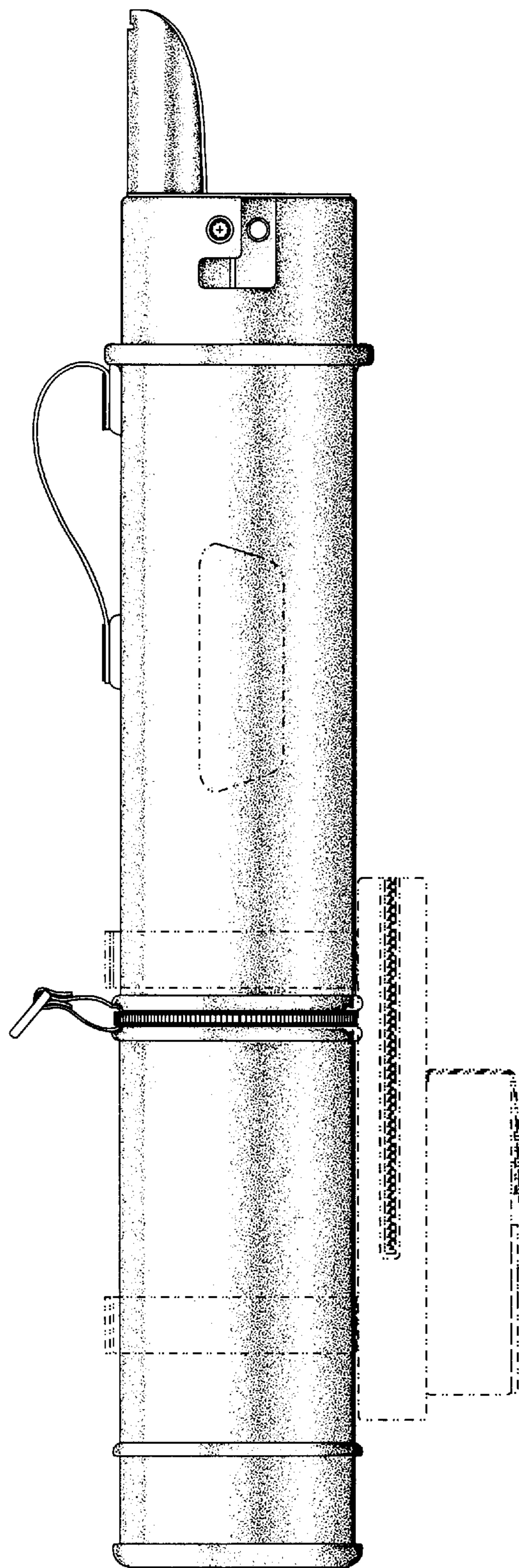

FIG. 4

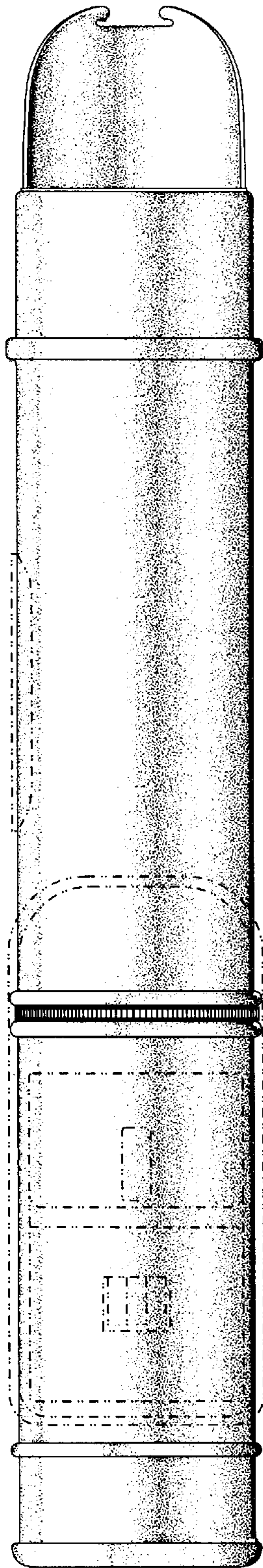

FIG. 5

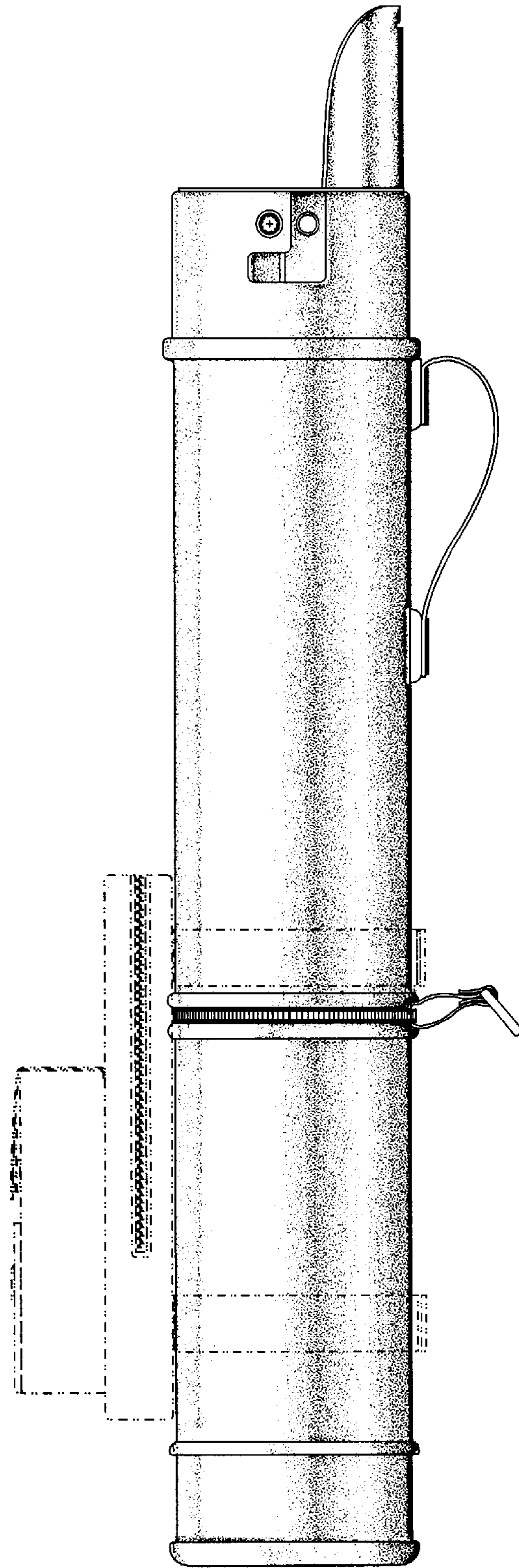

FIG. 6

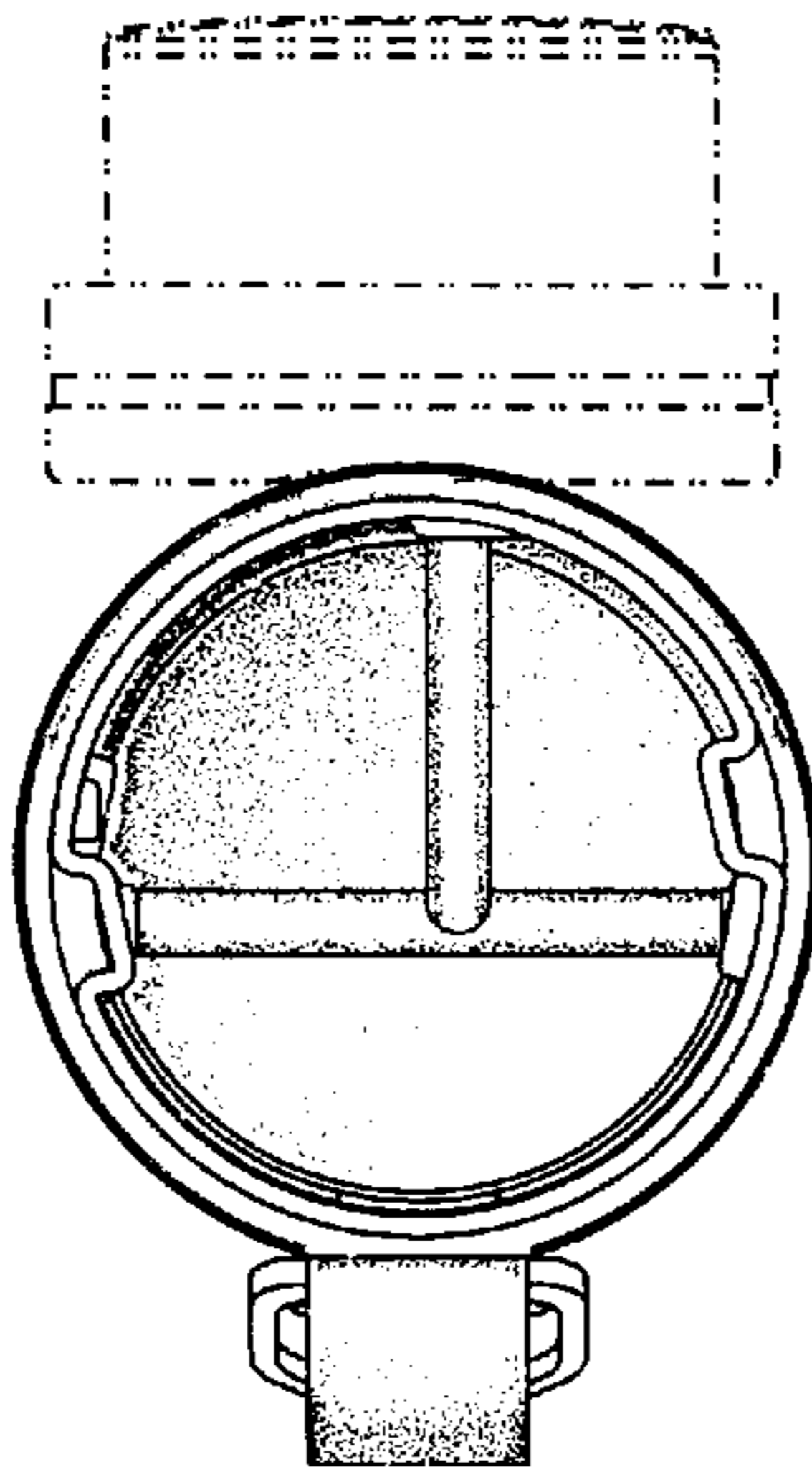

FIG. 7

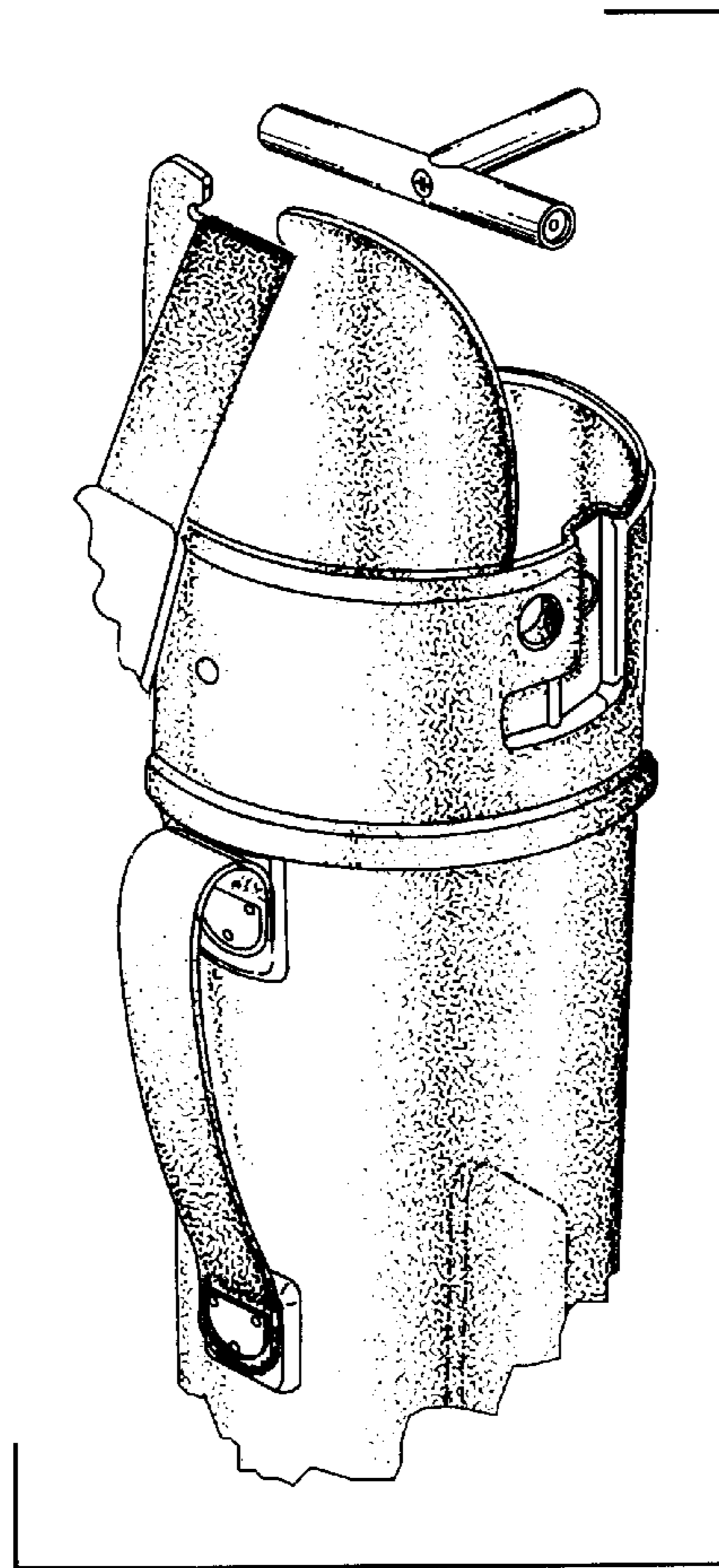

FIG. 8

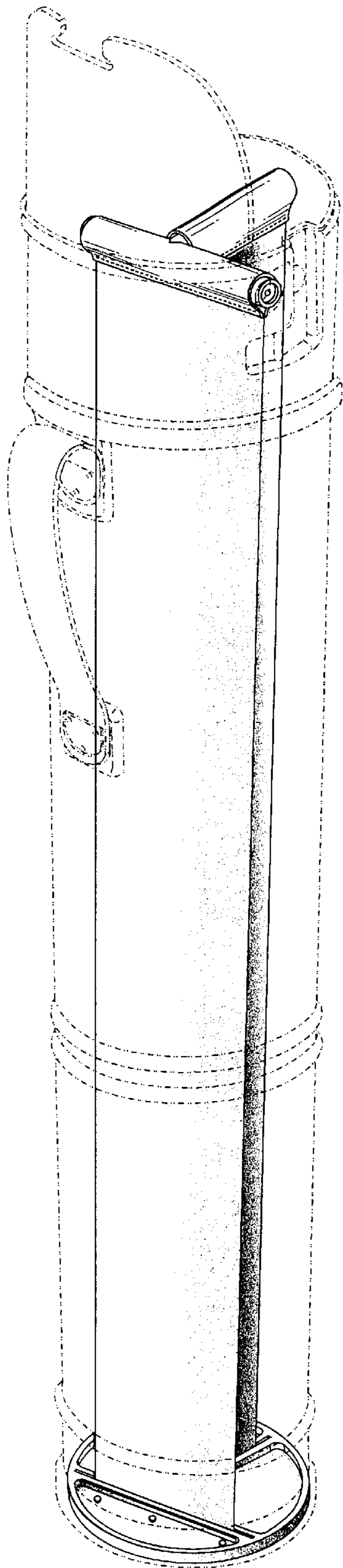

FIG. 9

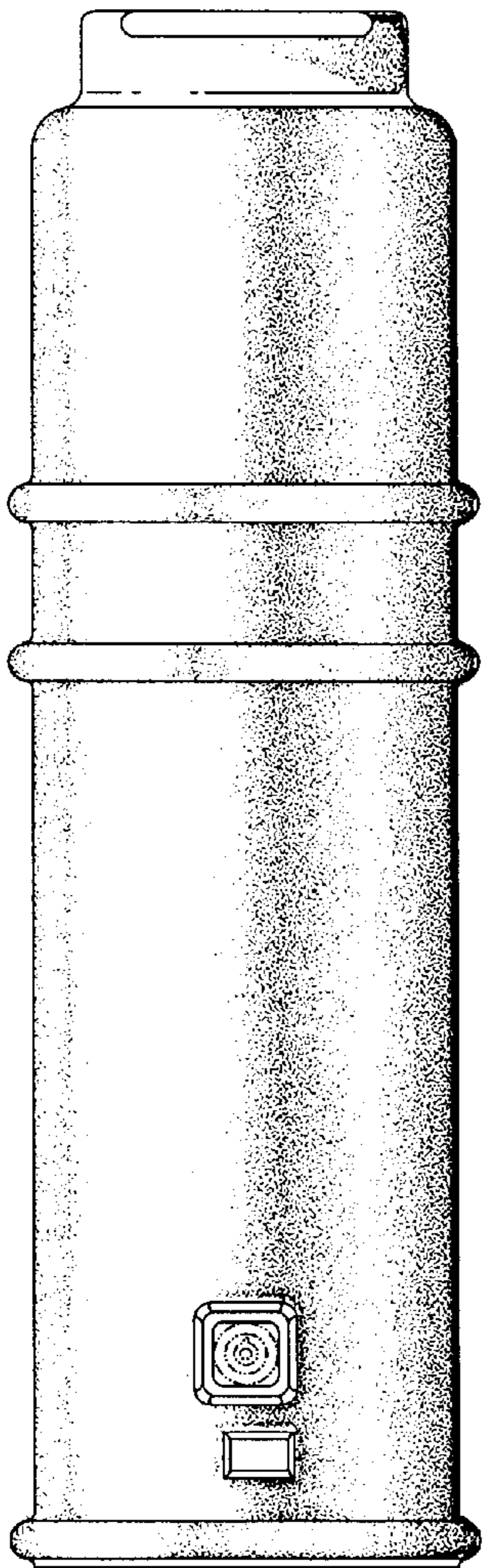

FIG. 10

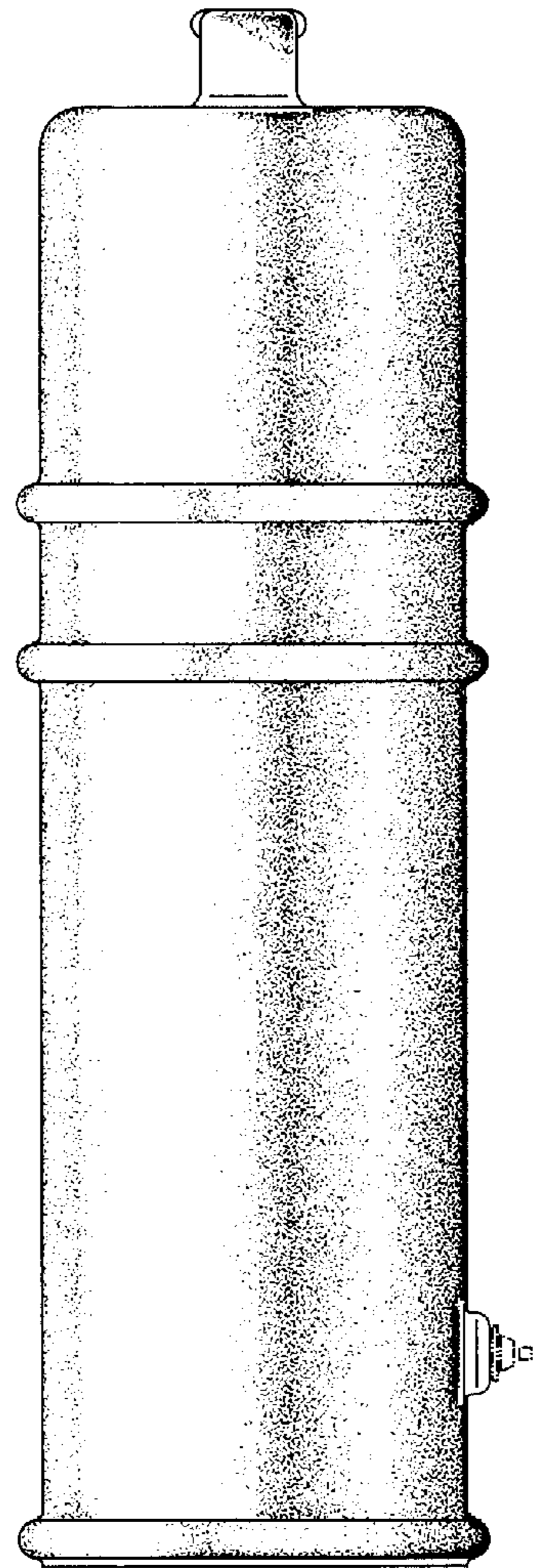

FIG. 11

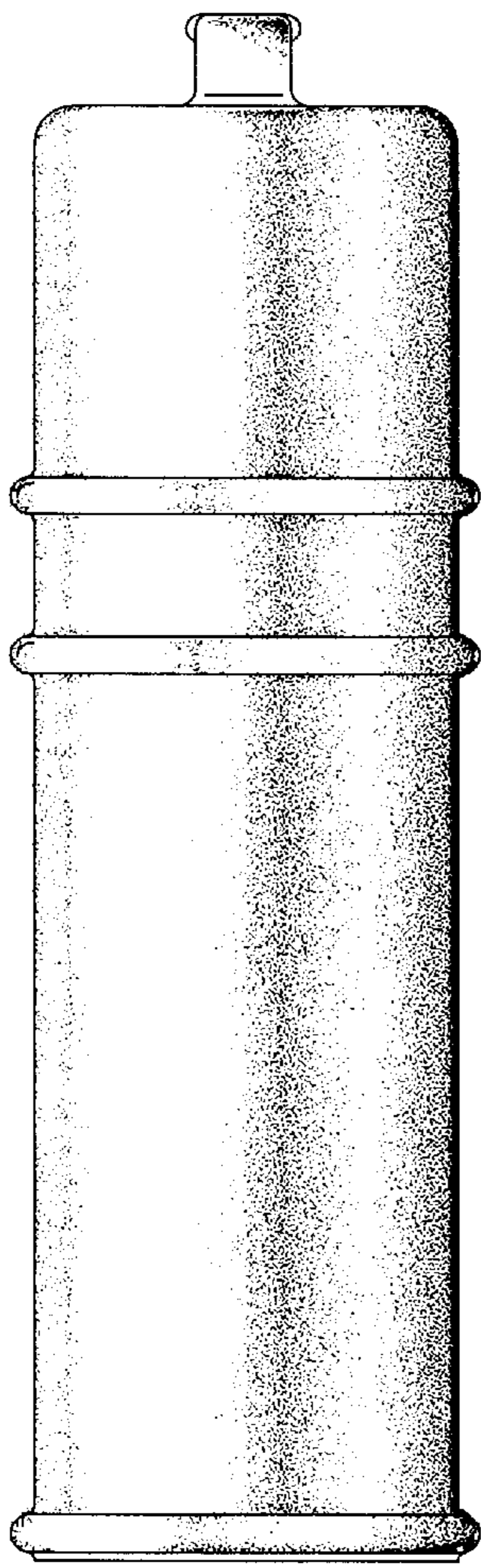

FIG. 12

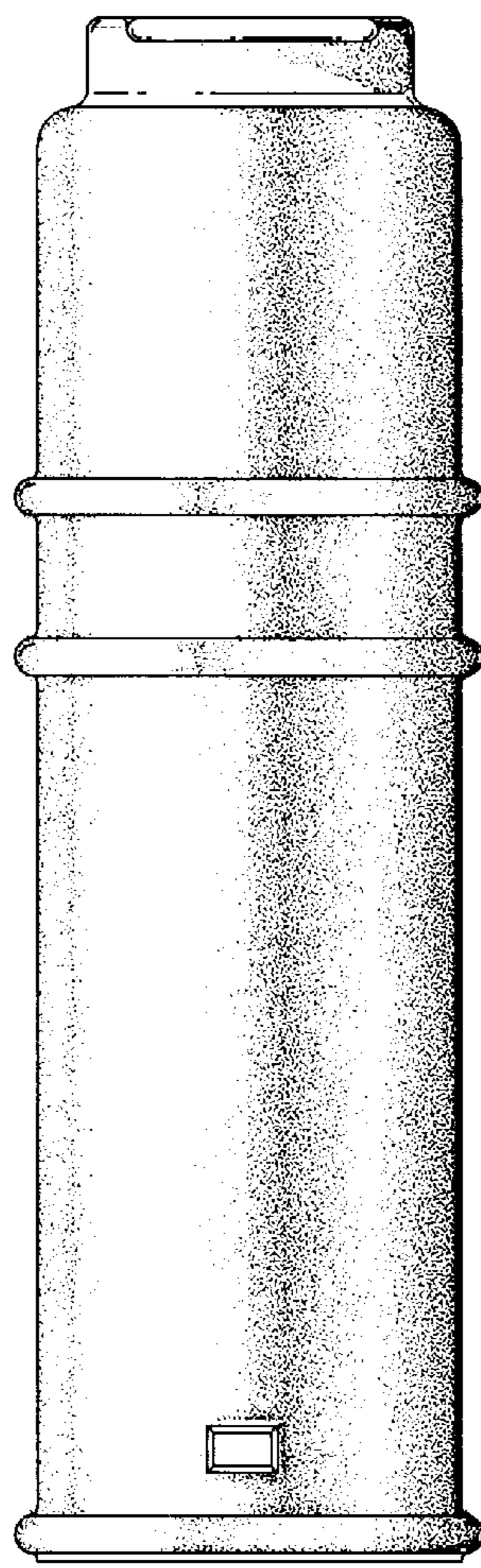

FIG. 13

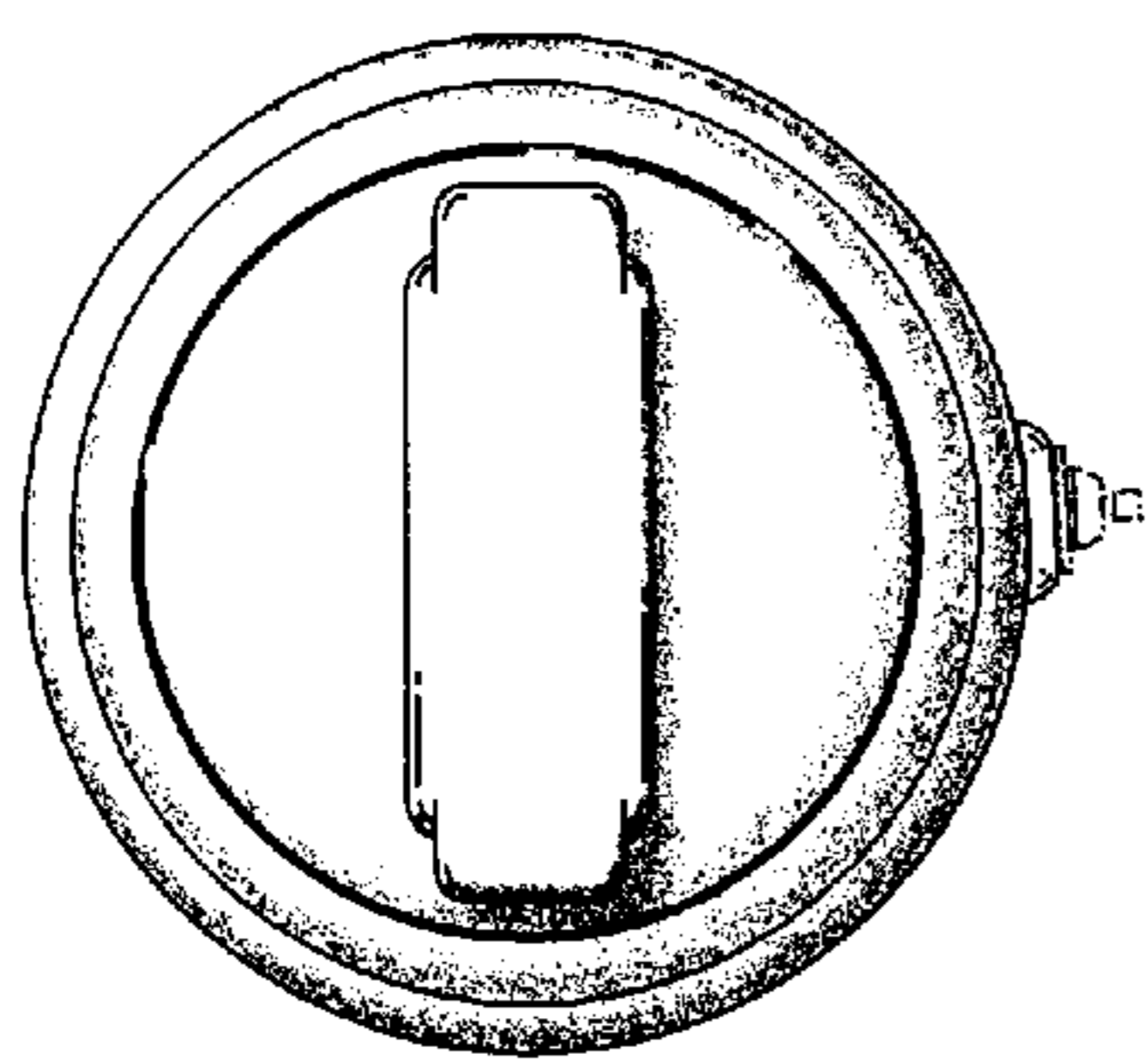

FIG. 14

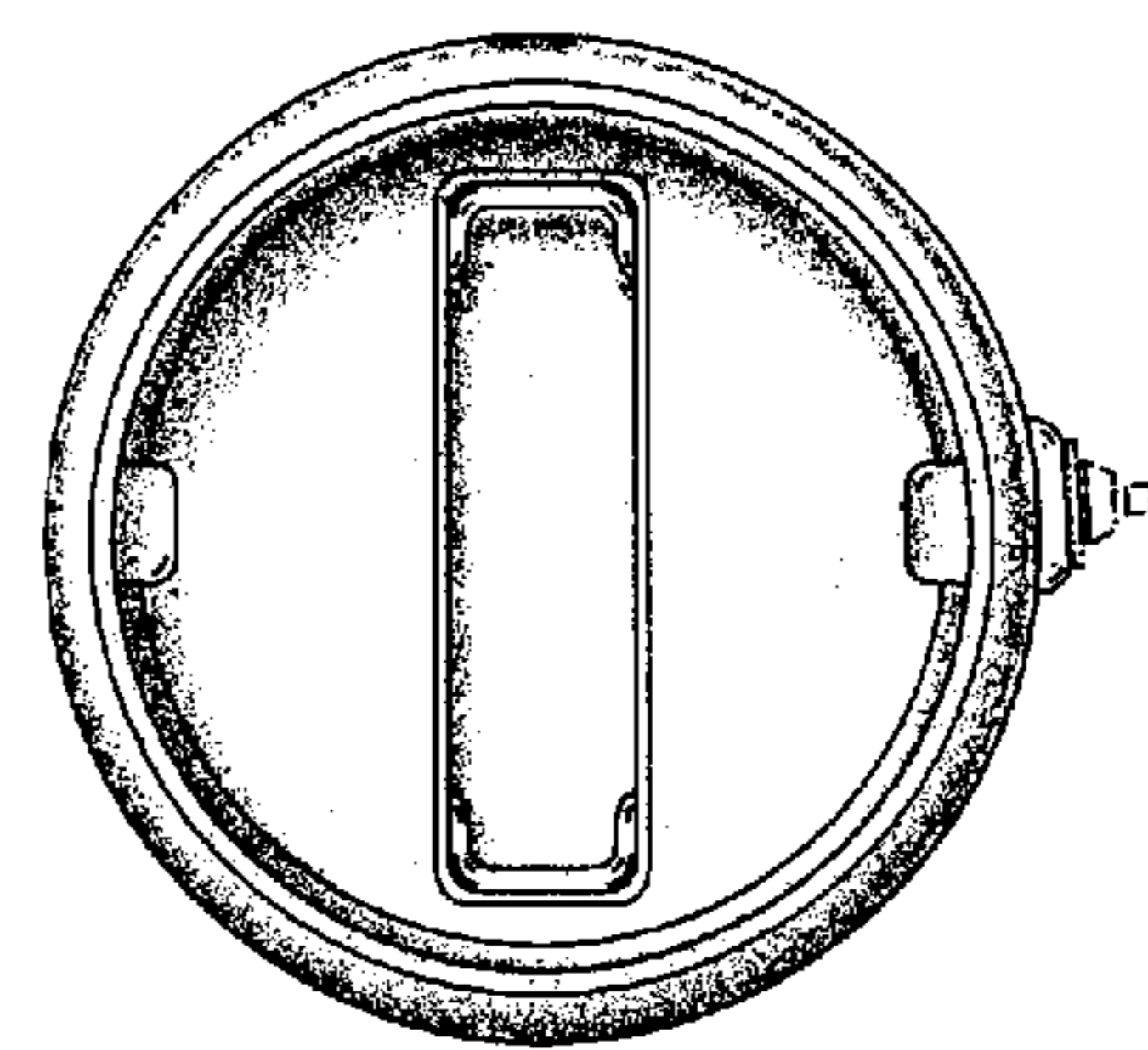

FIG. 15