



US00D472343S

(12) **United States Design Patent**
Lin

(10) **Patent No.:** **US D472,343 S**

(45) **Date of Patent:** **** Mar. 25, 2003**

(54) **LIGHTER**

D448,112 S 9/2001 Smith D27/157
D452,584 S 12/2001 Chen D27/157

(76) **Inventor:** **Hwai-Tay Lin**, Akara Building, 24 De Castro Street, Wickhams Cay I, Road Town, Tortola (VG)

Primary Examiner—Jennifer Rivard
(74) *Attorney, Agent, or Firm*—Alan Kamrath; Rider, Bennett, Egan & Arundel, LLP

(**) **Term:** **14 Years**

(57) **CLAIM**

(21) **Appl. No.:** **29/166,899**

The ornamental design for lighter, as shown and described.

(22) **Filed:** **Sep. 5, 2002**

DESCRIPTION

(51) **LOC (7) Cl.** **27-05**

(52) **U.S. Cl.** **D27/157**

(58) **Field of Search** D27/141, 148,
D27/154, 157; 431/153, 254, 255–256,
142, 143

FIG. 1 is a perspective view of a lighter showing my new design;
FIG. 2 is a front elevational view thereof; the opposite side being a mirror image of the shown;
FIG. 3 is a left elevational view thereof;
FIG. 4 is a right elevational view thereof;
FIG. 5 is a top plan view thereof; and,
FIG. 6 is bottom plan view thereof.

(56) **References Cited**

U.S. PATENT DOCUMENTS

D435,690 S 12/2000 Reynolds D27/141

1 Claim, 2 Drawing Sheets

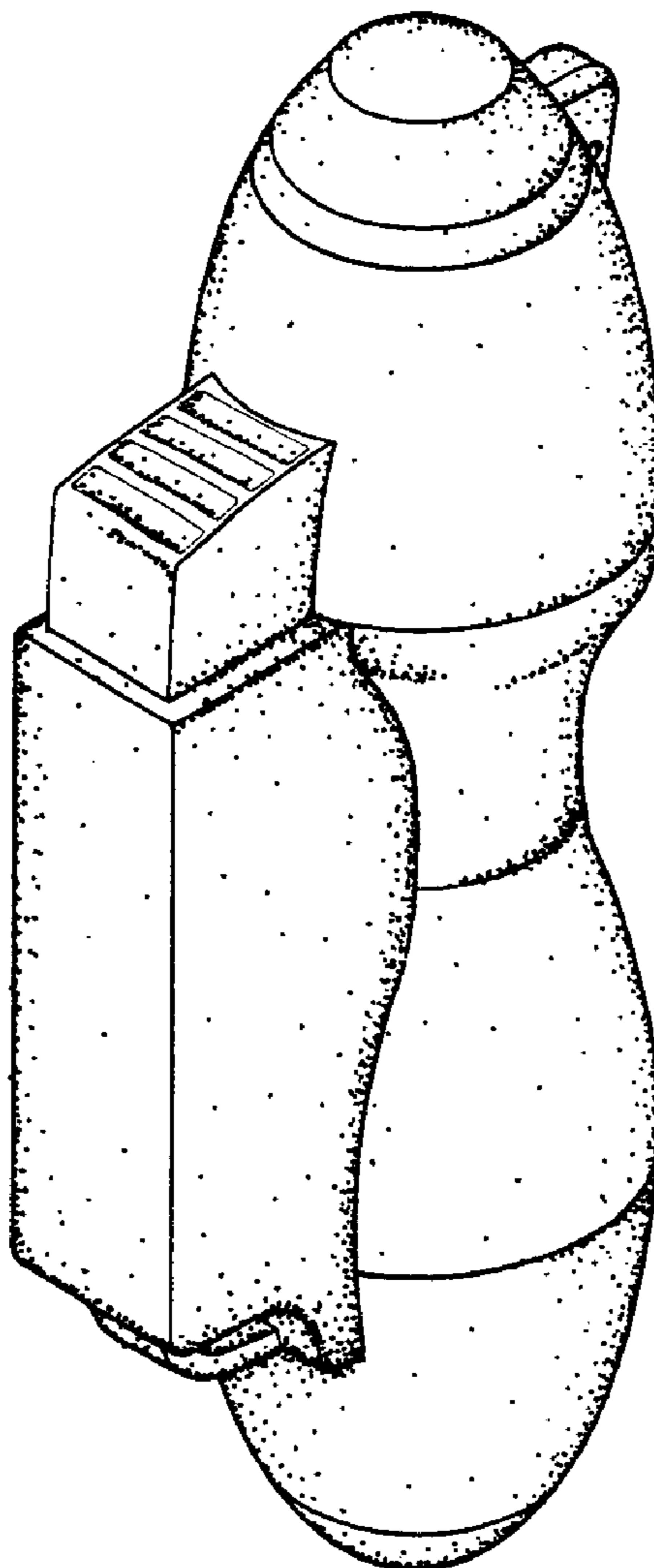

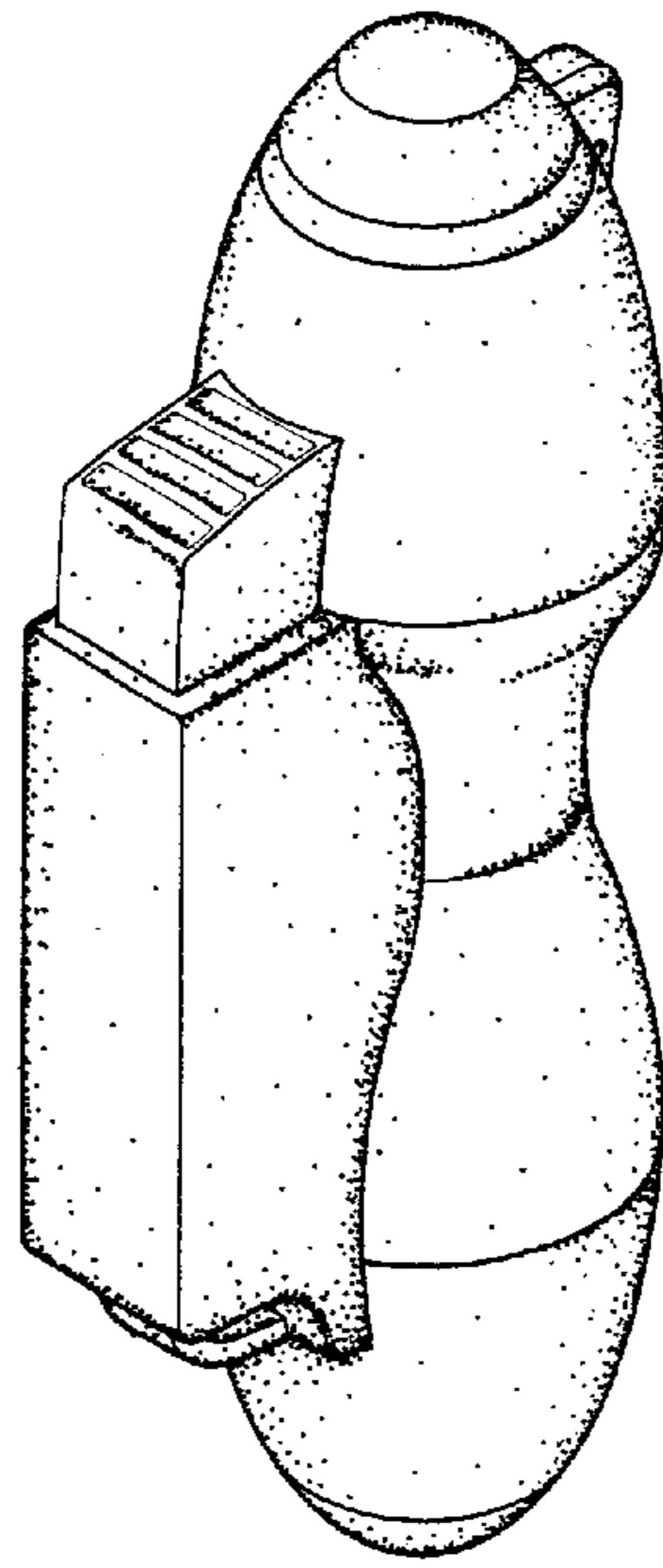

Fig. 1

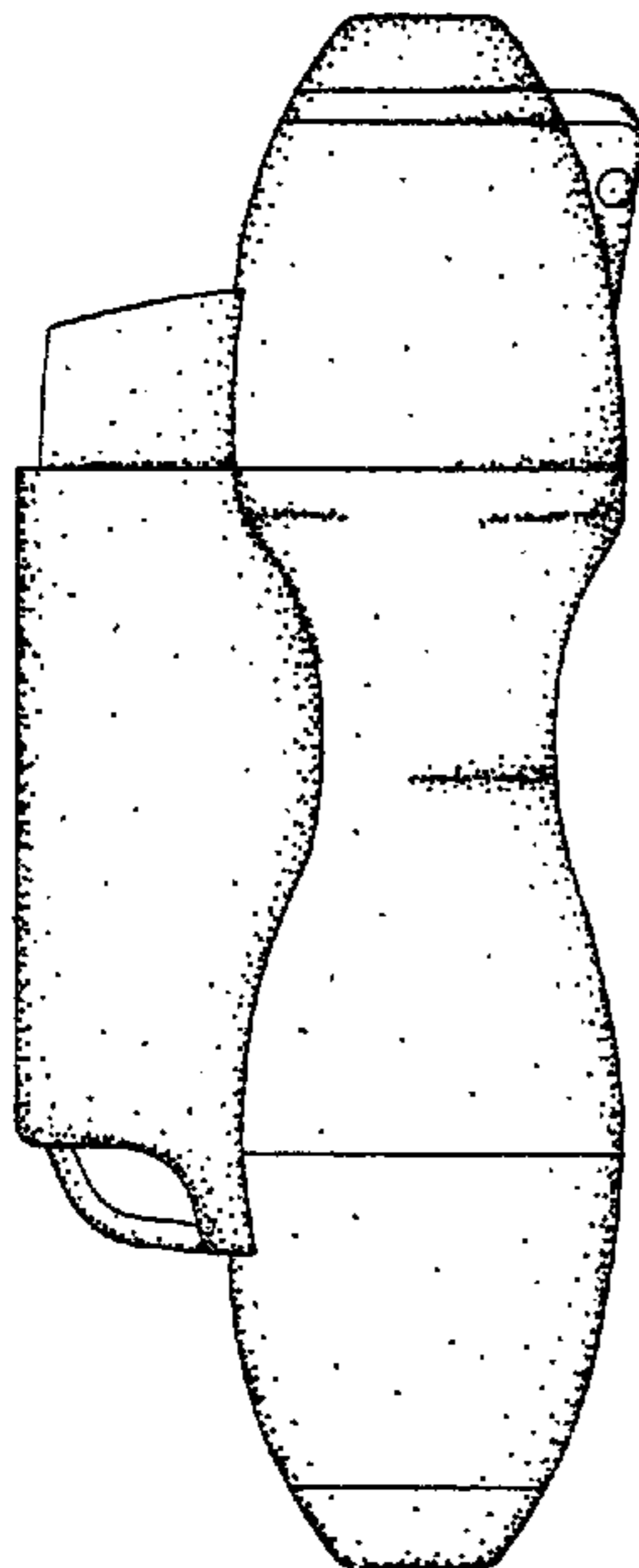

Fig. 2

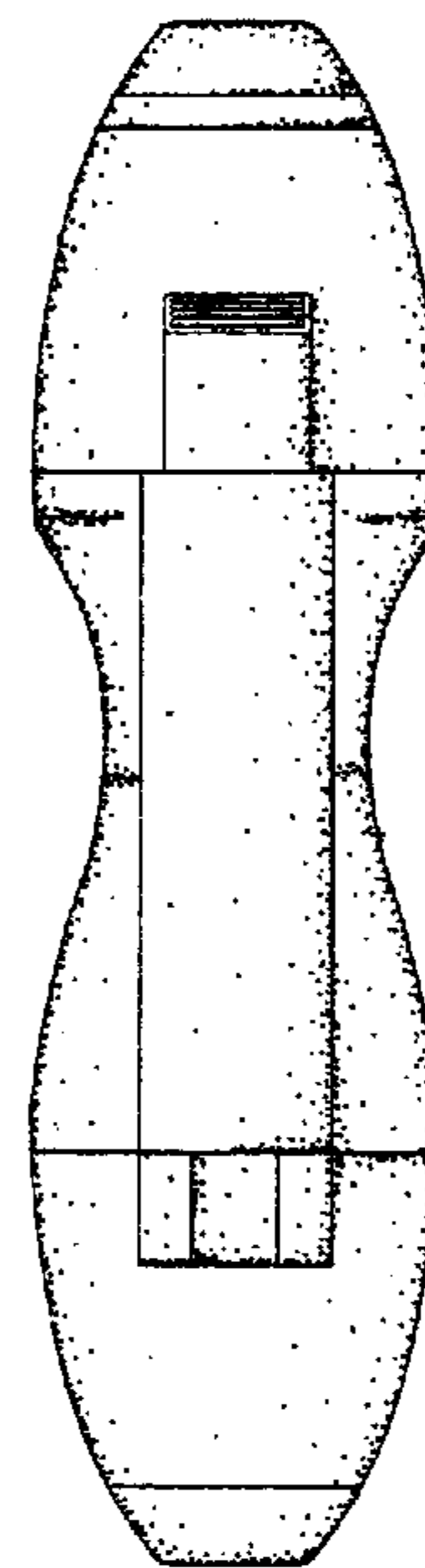

Fig. 3

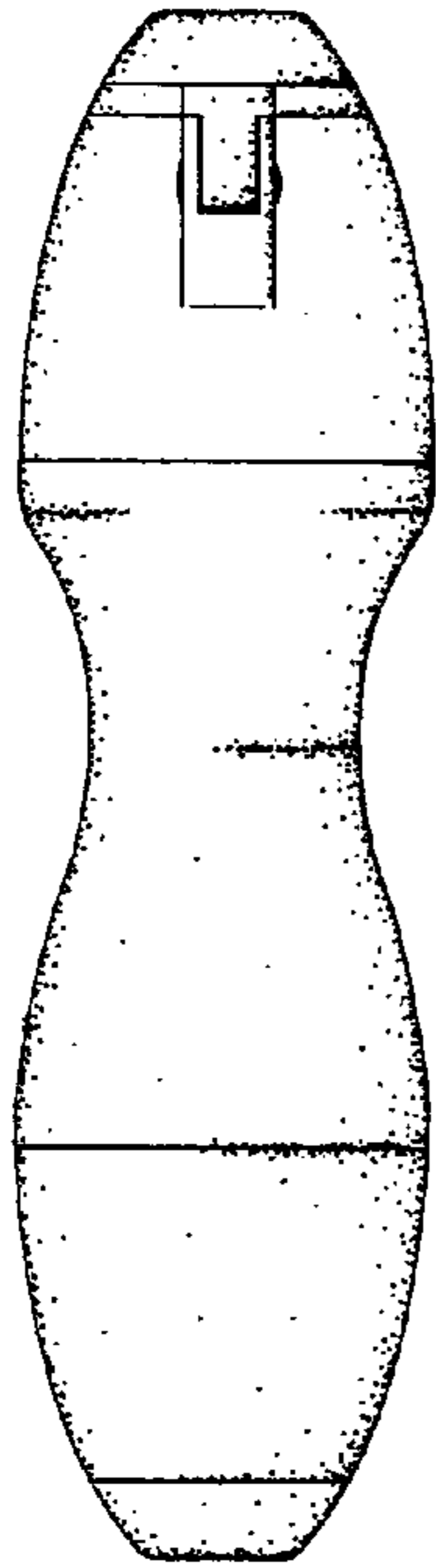

Fig. 4

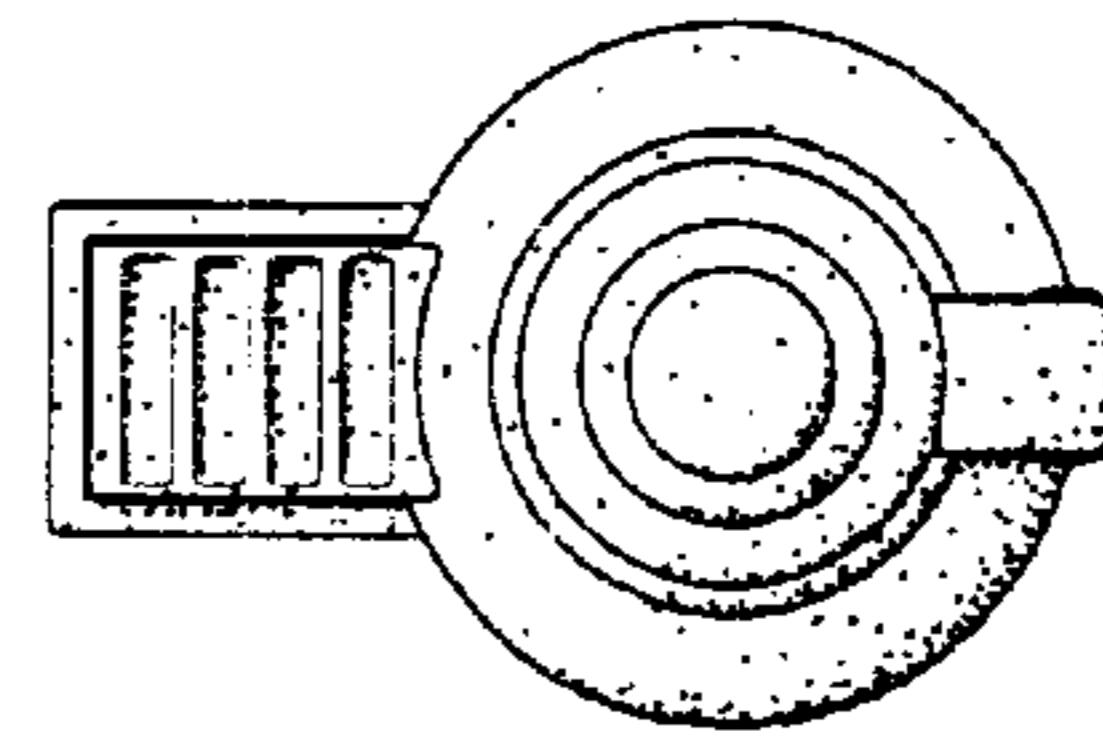

Fig. 5

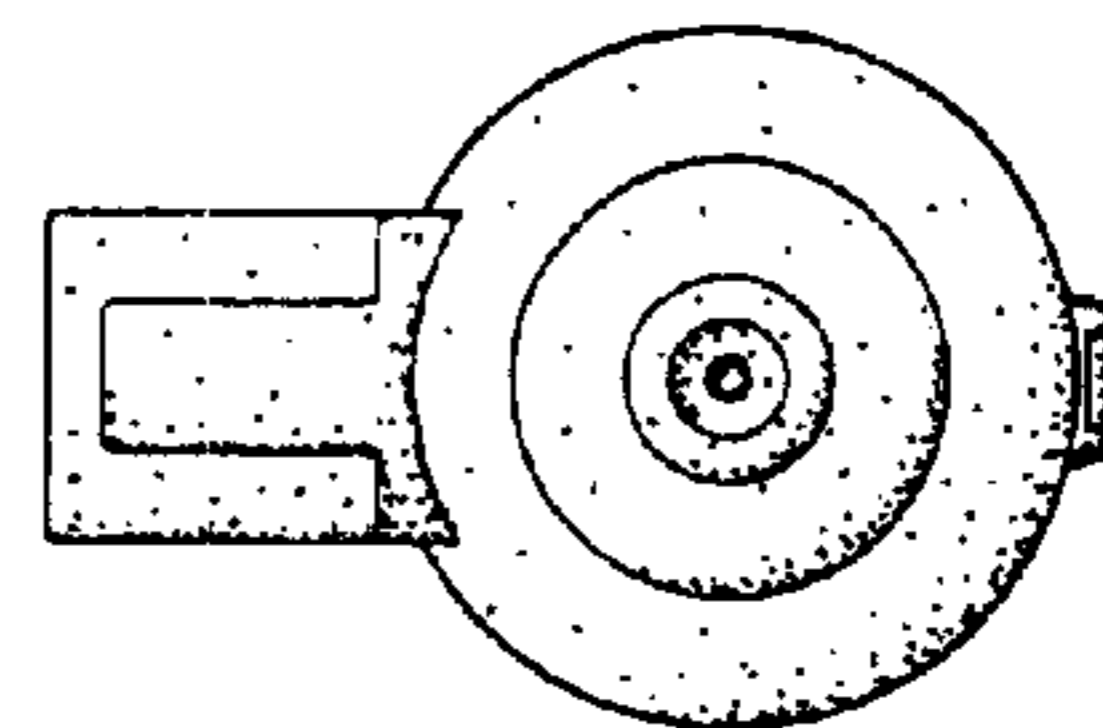

Fig. 6