



US00D472308S

(12) **United States Design Patent**  
**Hundley**

(10) **Patent No.:** **US D472,308 S**

(45) **Date of Patent:** **\*\* Mar. 25, 2003**

(54) **SPOUT**

(75) Inventor: **Jill E. Hundley**, Sheboygan, WI (US)

(73) Assignee: **Kohler Co.**, Kohler, WI (US)

(\*\*) Term: **14 Years**

(21) Appl. No.: **29/158,466**

(22) Filed: **Apr. 4, 2002**

(51) **LOC (7) Cl.** ..... **23-01**

(52) **U.S. Cl.** ..... **D23/255; D23/238; D23/257**

(58) **Field of Search** ..... **D23/238-243, D23/250-257; 4/675-678; 137/801**

(56) **References Cited**

**U.S. PATENT DOCUMENTS**

D175,660 S	9/1955	Welch	.....	D65/1
D254,801 S	4/1980	Santi	.....	D23/23
D267,110 S	* 11/1982	Arnolds	.....	D23/242
D322,658 S	* 12/1991	Kohler, Jr. et al.	.....	D23/255
D322,841 S	12/1991	Kohler, Jr. et al.	.....	D23/255
D349,330 S	8/1994	Sauter et al.	.....	D23/255
D409,292 S	* 5/1999	Hyde et al.	.....	D23/255
D461,540 S	* 8/2002	Gottwald	.....	D23/255

**OTHER PUBLICATIONS**

Jul. 2001 Kohler catalog ad, p. 2.43a, showing a "Stillness" spout.

\* cited by examiner

*Primary Examiner*—Louis S. Zarfaz

*Assistant Examiner*—Gregory Andoll

(74) *Attorney, Agent, or Firm*—Quarles & Brady LLP

(57) **CLAIM**

The ornamental design for a spout, as shown and described.

**DESCRIPTION**

In a preferred embodiment, the nature of this product is as a spout for a plumbing fixture in the form of a faucet which is primarily useful for washing various objects.

FIG. 1 is a left, top, front perspective view of a spout embodying my new design;

FIG. 2 is a left side elevational view thereof, the right side elevational view being a mirror image of the left side shown;

FIG. 3 is a front elevational view thereof;

FIG. 4 is a rear elevational view thereof;

FIG. 5 is a top plan view thereof;

FIG. 6 is a bottom plan view thereof;

FIG. 7 is a left, top, front perspective view of a second embodiment;

FIG. 8 is a left side elevational view, the right side elevational view being a mirror image of the left side shown;

FIG. 9 is a front elevational view;

FIG. 10 is a rear elevational view;

FIG. 11 is a top plan view; and,

FIG. 12 is a bottom plan view.

The broken line representation of mounting structure in FIGS. 6 and 12 is for the purpose of illustration only, and forms no part of the claimed design.

**1 Claim, 6 Drawing Sheets**

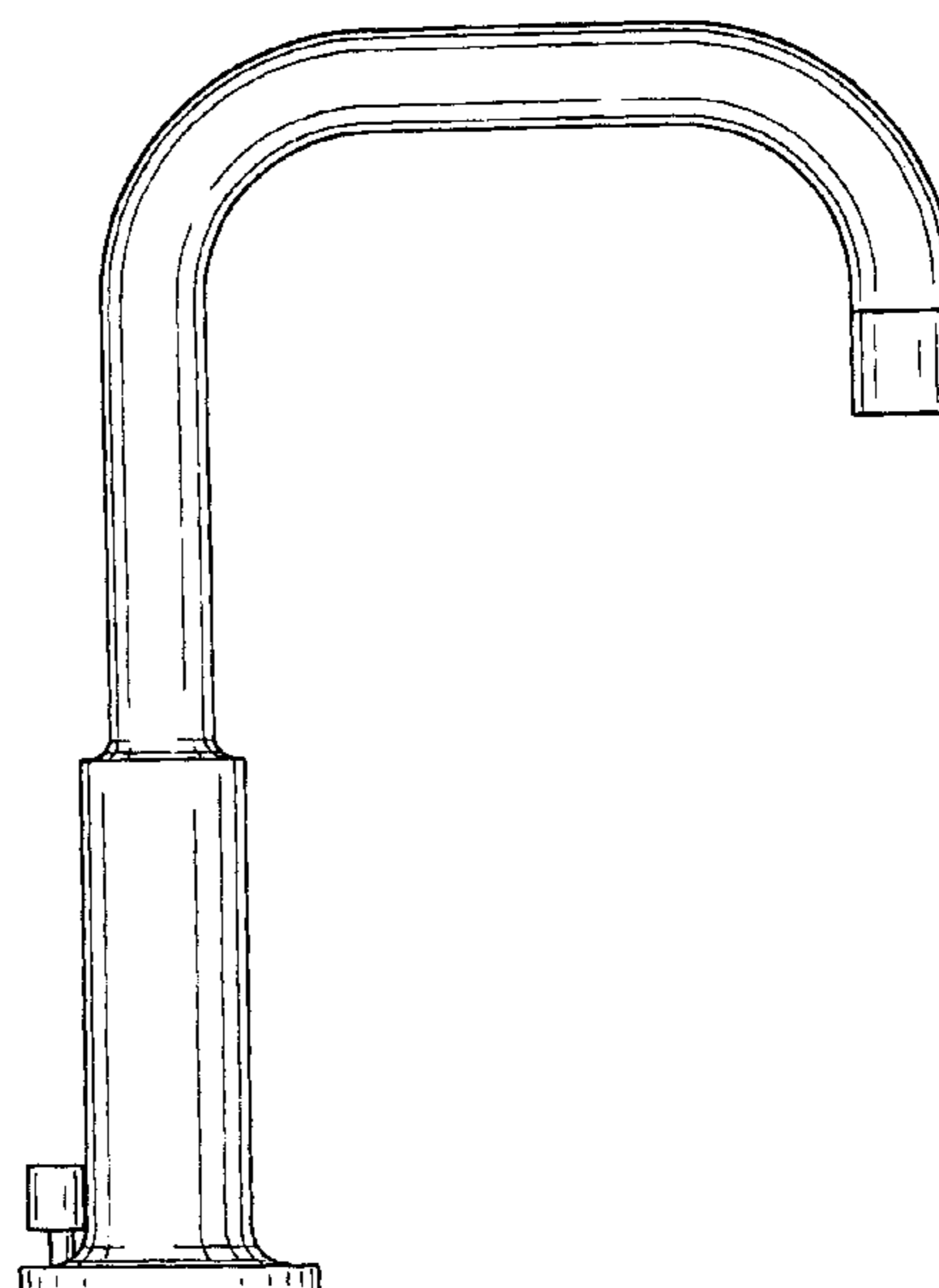
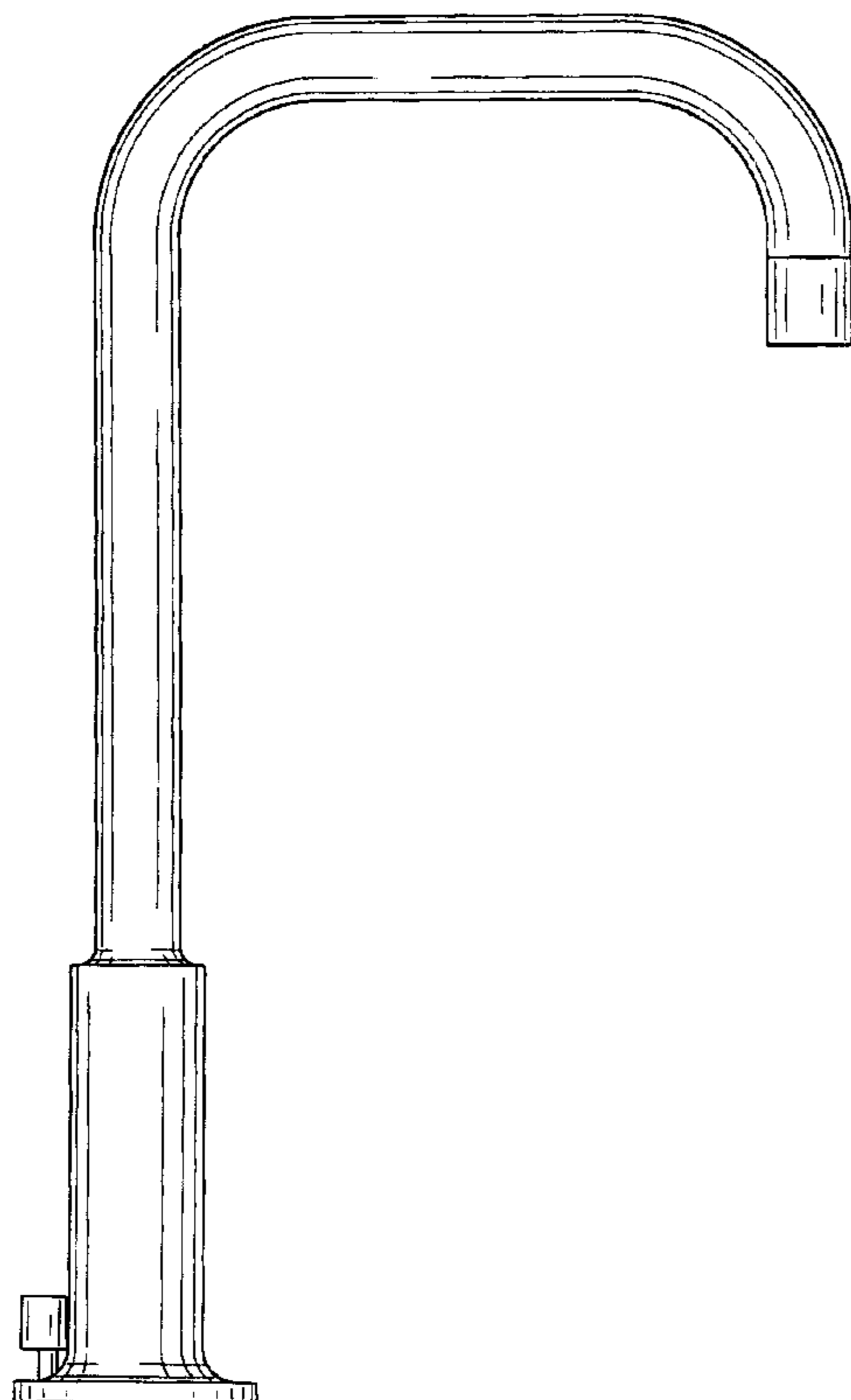
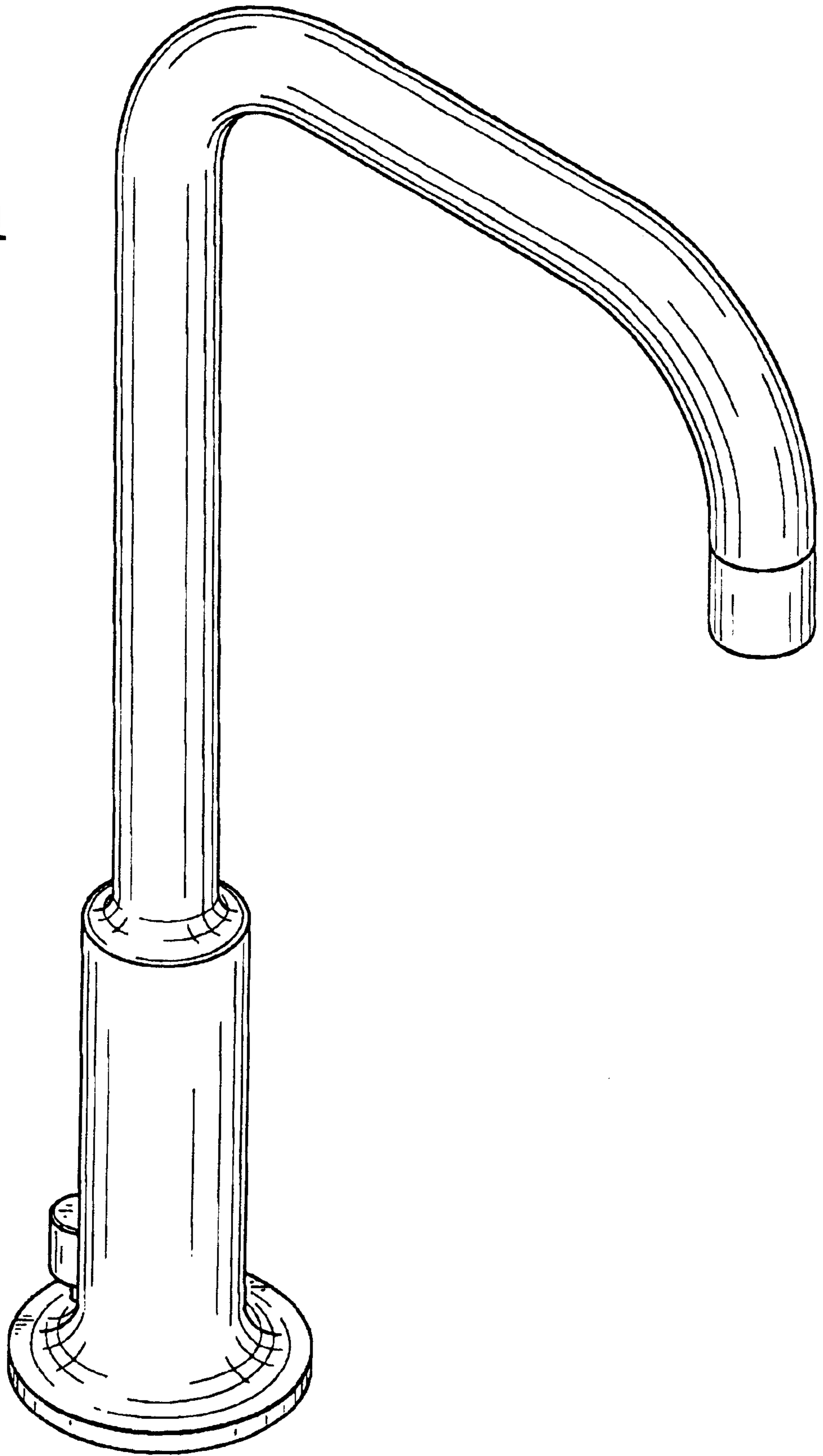

FIG. 1



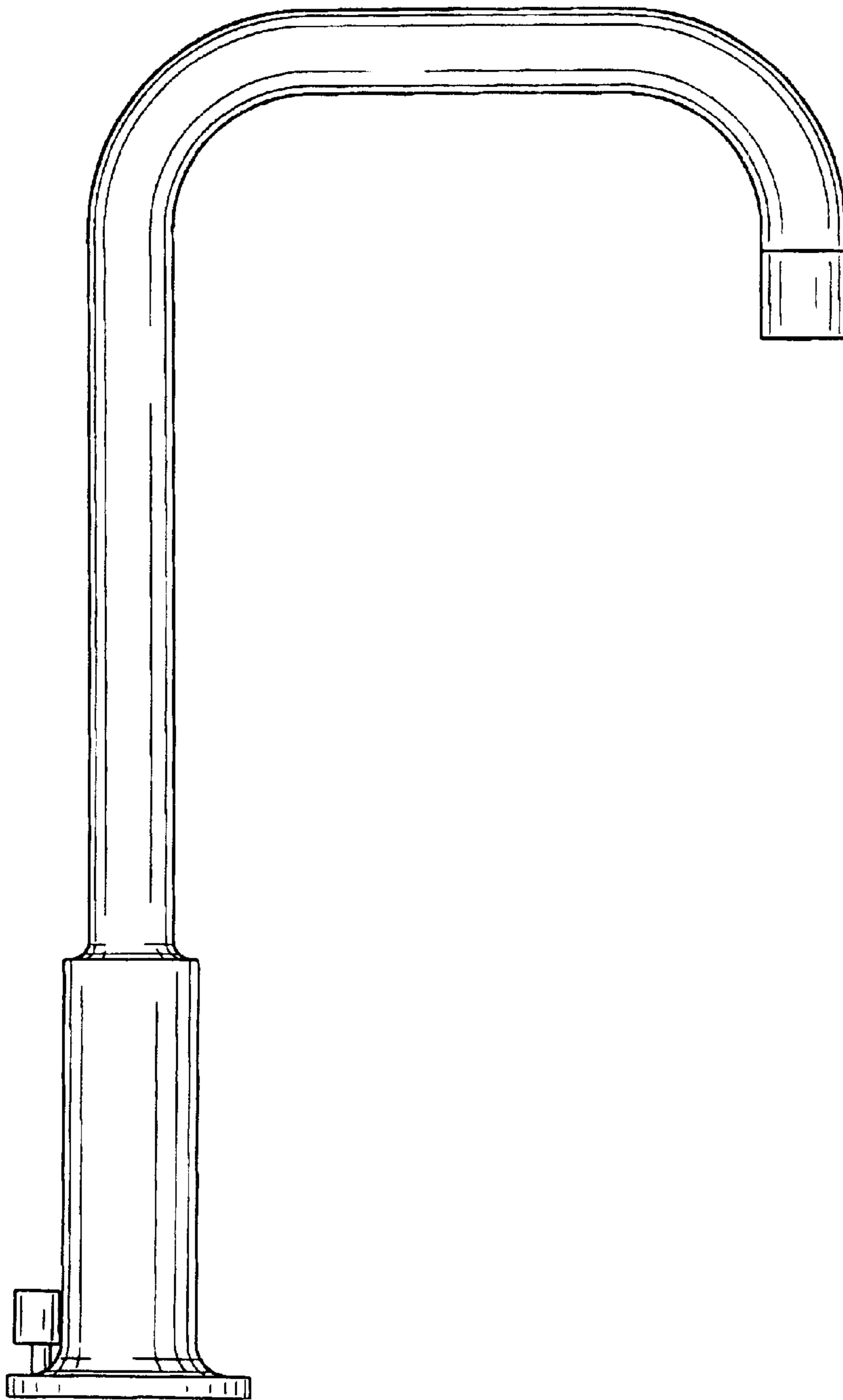

FIG. 2

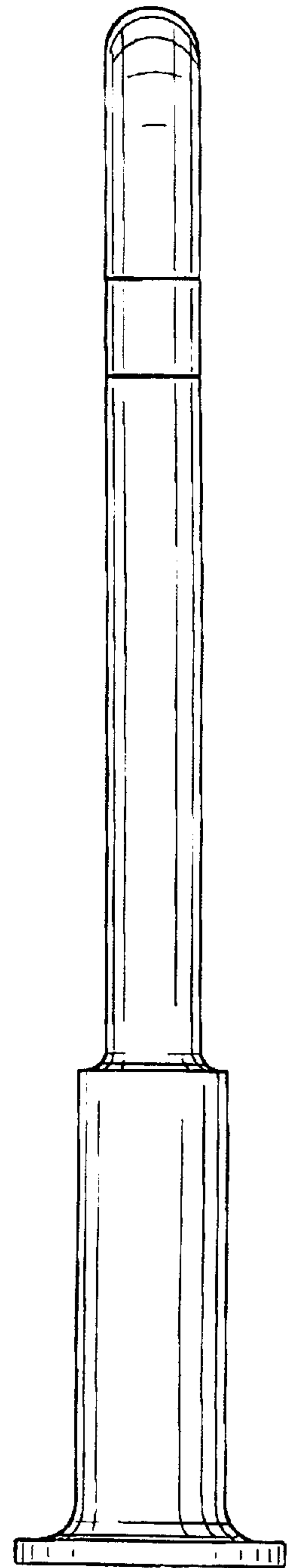

FIG. 3

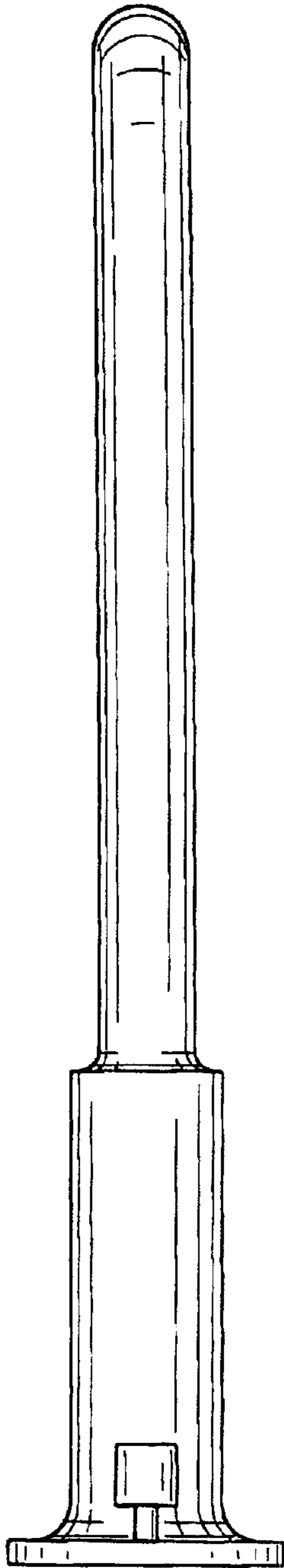

FIG. 4

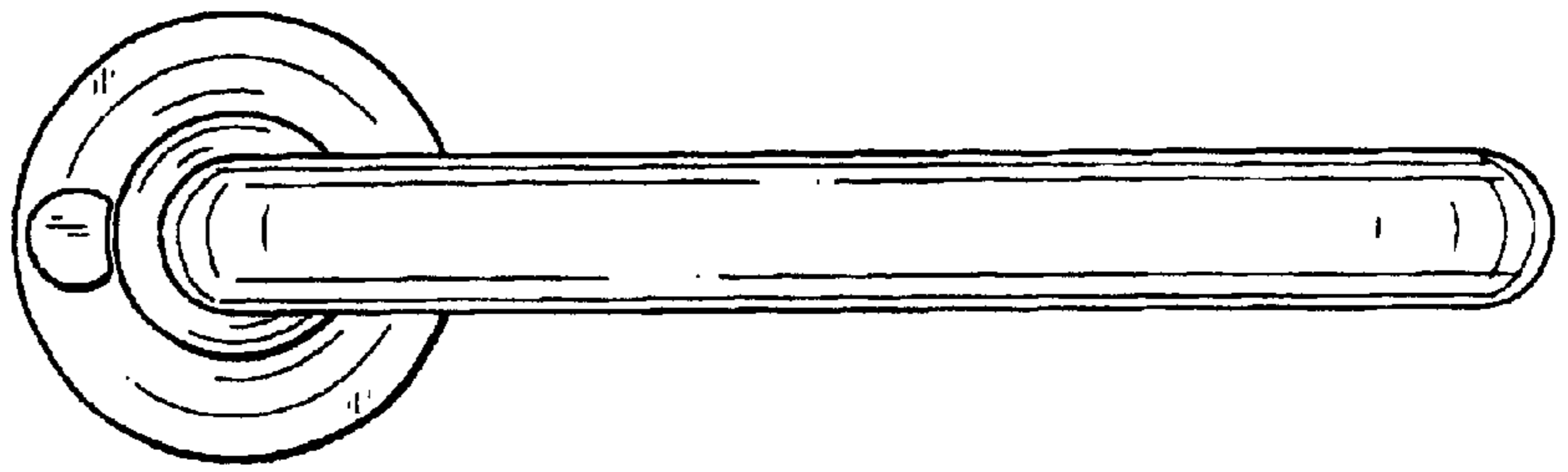

FIG. 5

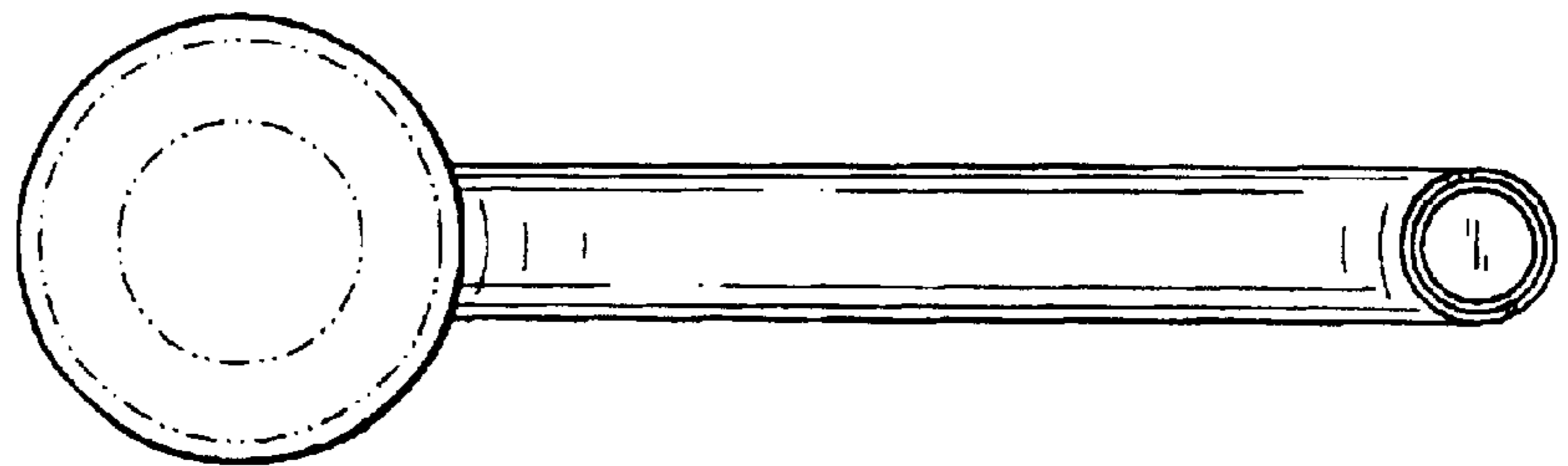
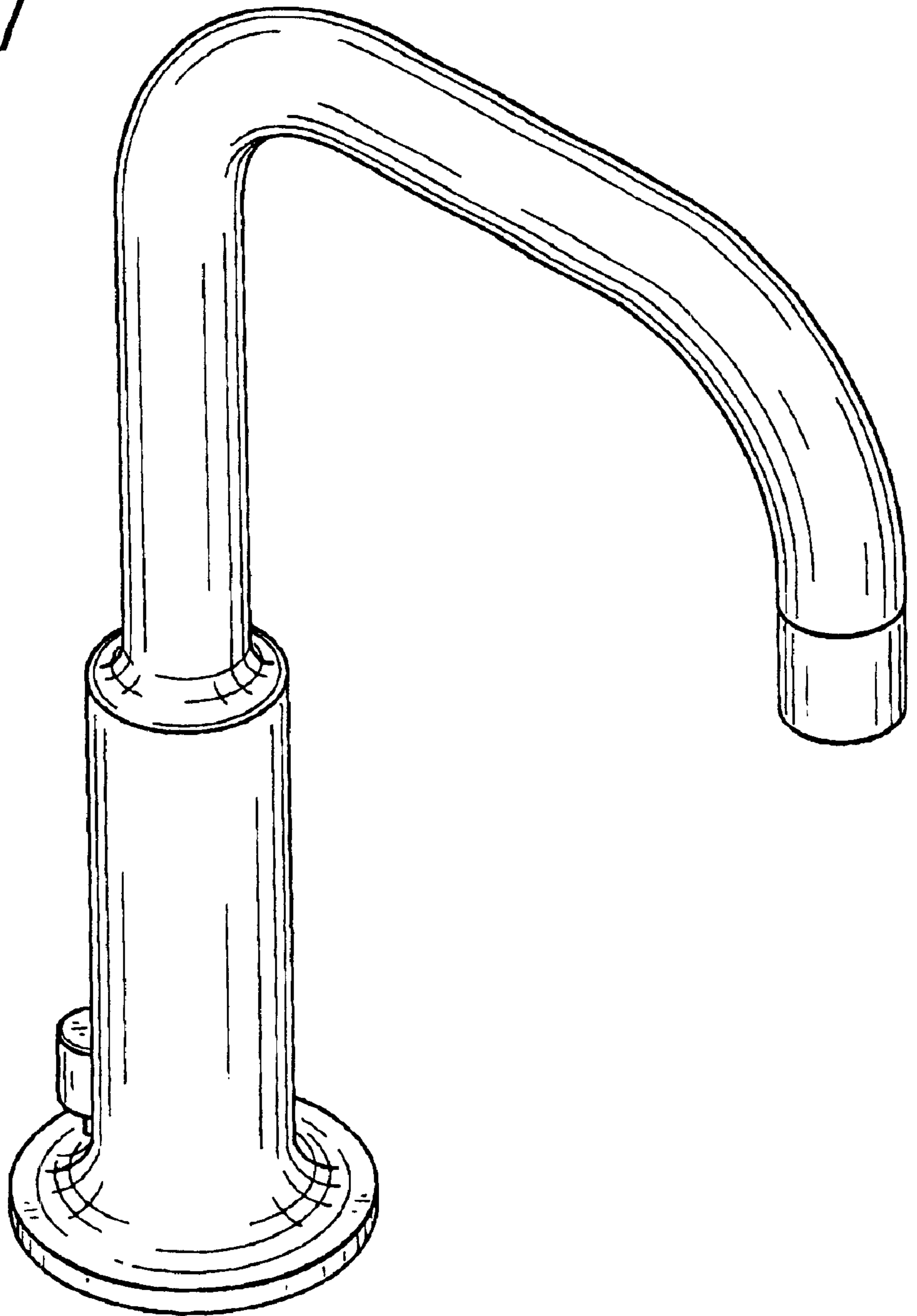

FIG. 6

FIG. 7



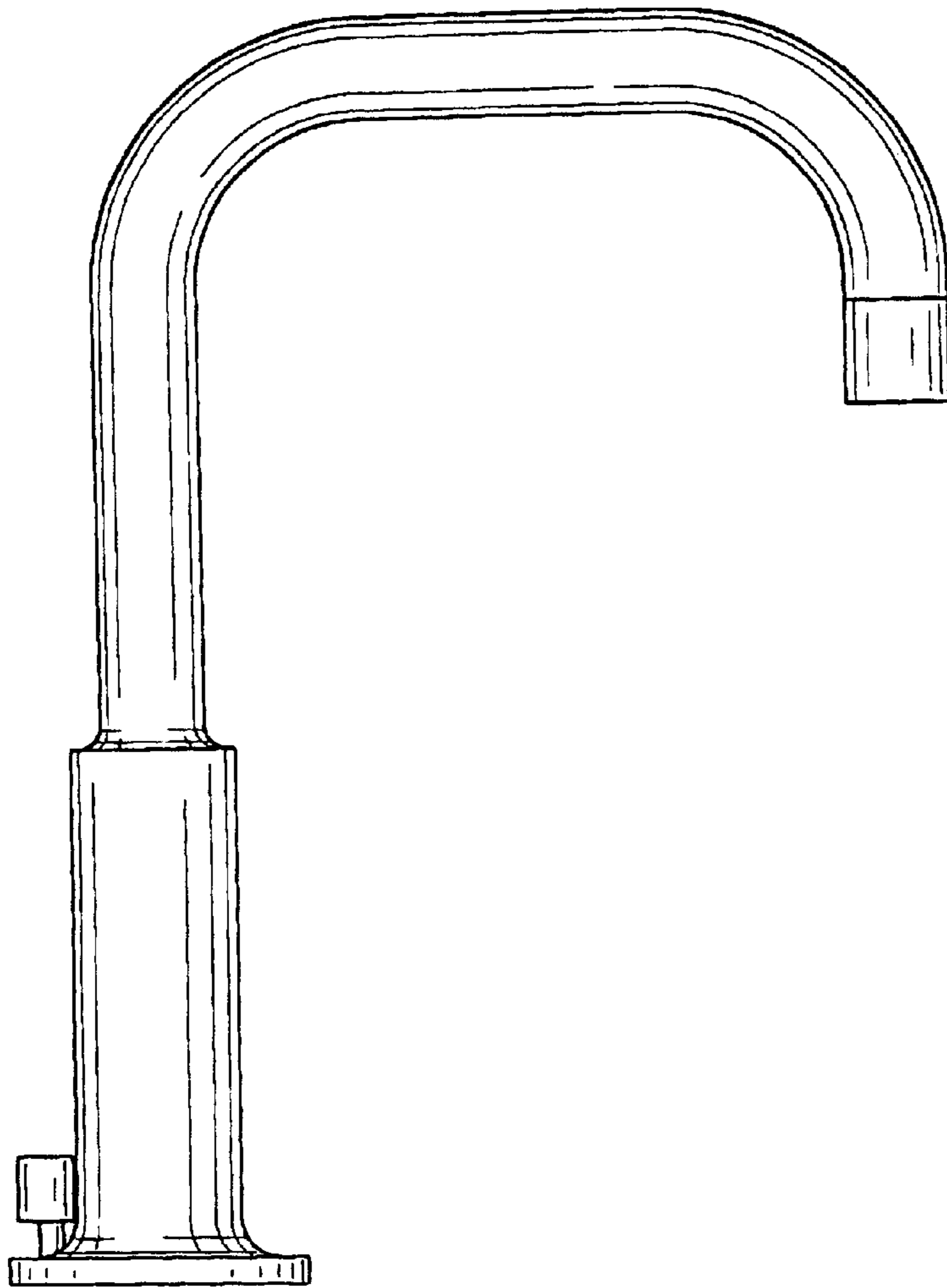

FIG. 8

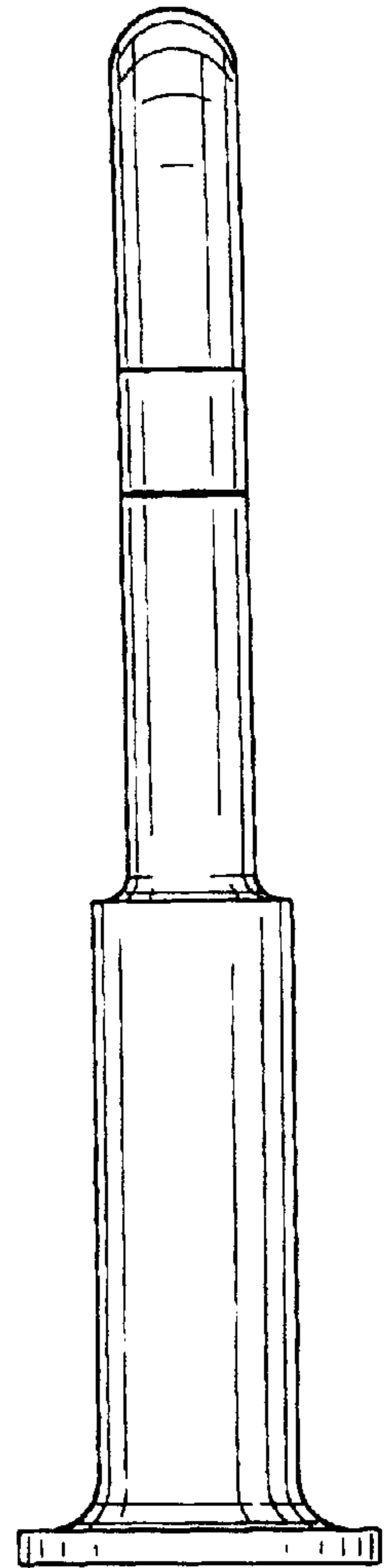

FIG. 9



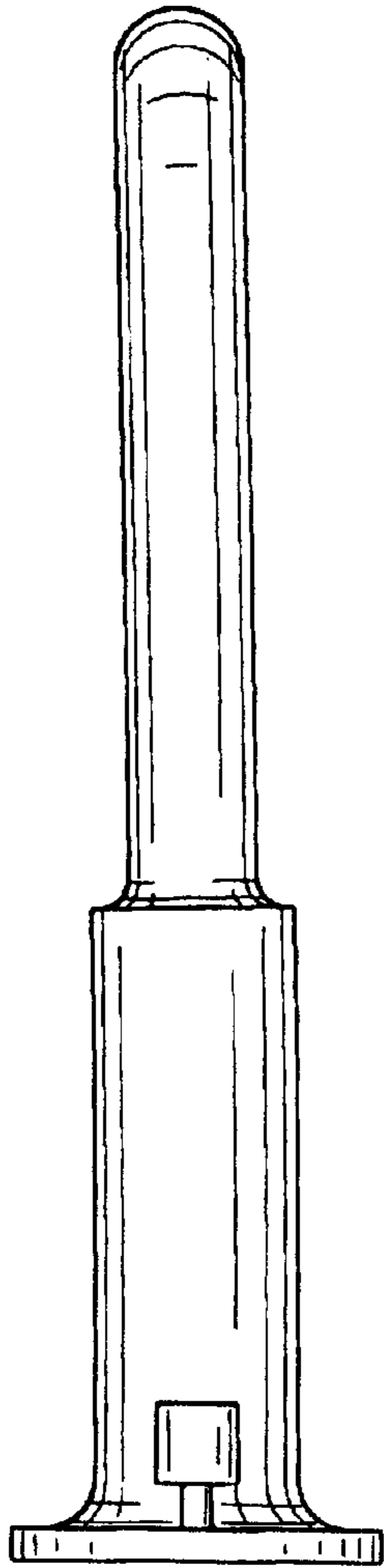

FIG. 10

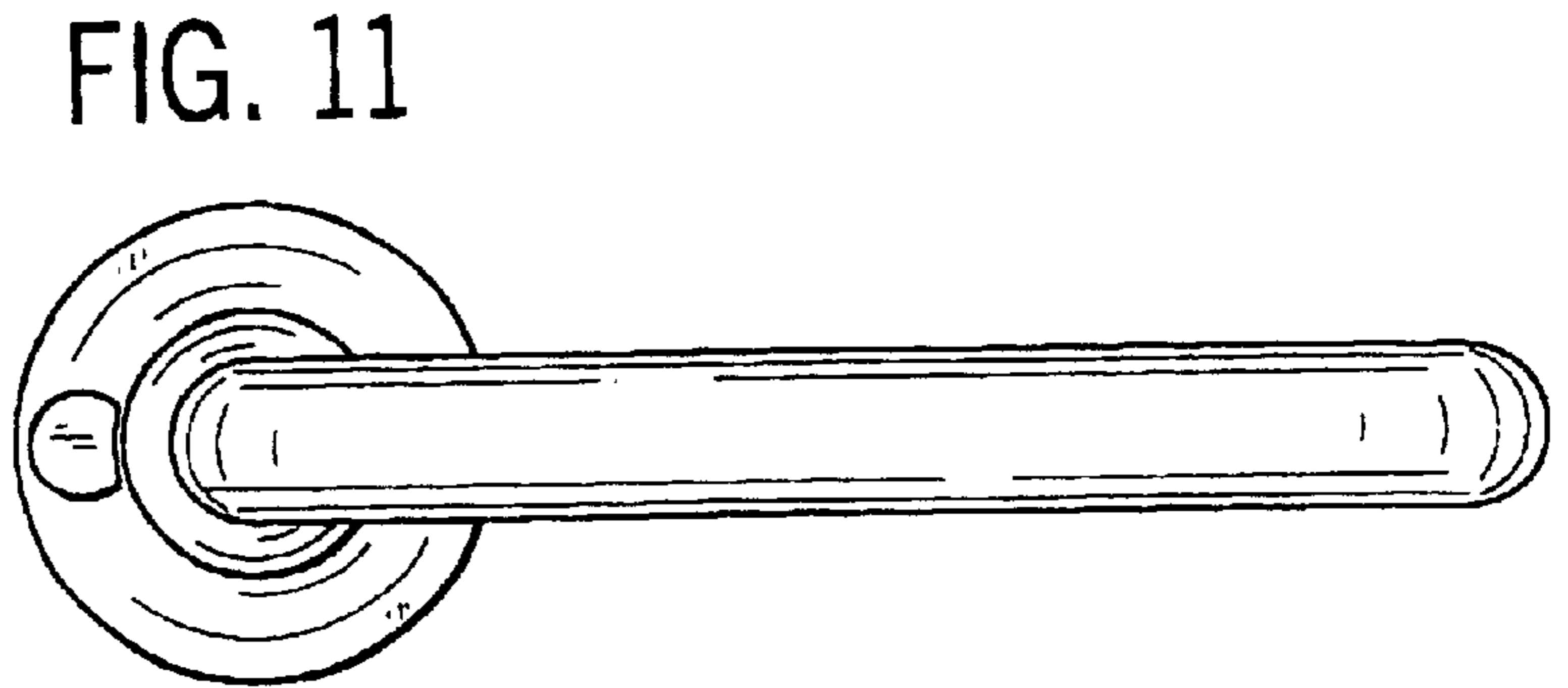

FIG. 11

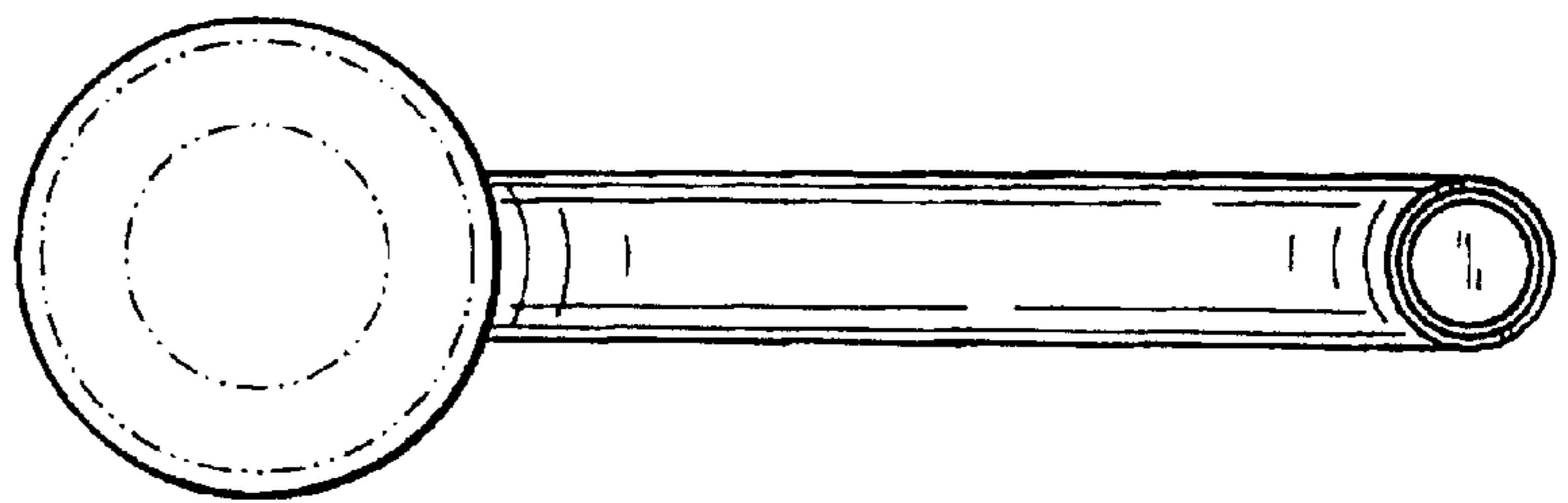

FIG. 12