



US00D472210S

(12) **United States Design Patent**  
**Tada et al.**

(10) **Patent No.:** **US D472,210 S**

(45) **Date of Patent:** **\*\* Mar. 25, 2003**

(54) **BATTERY**

(75) Inventors: **Futoshi Tada**, Osaka (JP); **Kenji Yamamoto**, Osaka (JP); **Susumu Kato**, Osaka (JP)

(73) Assignee: **Matsushita Electric Industrial Co., Ltd.**, Osaka (JP)

(\*\*) Term: **14 Years**

(21) Appl. No.: **29/164,536**

(22) Filed: **Jul. 25, 2002**

(51) **LOC (7) Cl.** ..... **13-02**

(52) **U.S. Cl.** ..... **D13/120**

(58) **Field of Search** ..... D13/120, 133; D11/220; 439/500, 775, 799, 816-818, 834, 848, 856, 857, 859, 860; 429/121, 178; 24/108, 662, 672, 677, 681

(56) **References Cited**

**U.S. PATENT DOCUMENTS**

- 3,347,709 A \* 10/1967 Taylor et al. .... 429/153
- 4,147,838 A \* 4/1979 Leffingwell ..... 429/178 X
- D252,990 S \* 9/1979 Gietzen ..... D13/120
- 4,226,497 A \* 10/1980 Polonsky et al. .... 439/677
- 4,239,322 A \* 12/1980 Gordon, Jr. .... 439/458

- 4,394,059 A \* 7/1983 Reynolds ..... 439/500
- 4,602,202 A \* 7/1986 Mundschenk et al. .... 320/106
- 5,134,046 A \* 7/1992 Chow et al. .... 429/176
- 5,312,269 A \* 5/1994 Hwang ..... 439/500
- 5,421,743 A \* 6/1995 Hwang ..... 439/500
- 5,908,328 A \* 6/1999 Chen ..... 439/500

\* cited by examiner

*Primary Examiner*—Joel Sincavage

(74) *Attorney, Agent, or Firm*—Christensen O'Connor Johnson Kindness PLLC

(57) **CLAIM**

The ornamental design for a battery, as shown and described.

**DESCRIPTION**

FIG. 1 is a perspective view of the top, front and left side of a battery showing our new design;  
 FIG. 2 is a front view thereof;  
 FIG. 3 is a top plan thereof;  
 FIG. 4 is a bottom view thereof;  
 FIG. 5 is a rear view thereof;  
 FIG. 6 is a left side view thereof; and,  
 FIG. 7 is a right side view thereof.

The elements shown in phantom lines do not form any part of the claimed design.

**1 Claim, 2 Drawing Sheets**

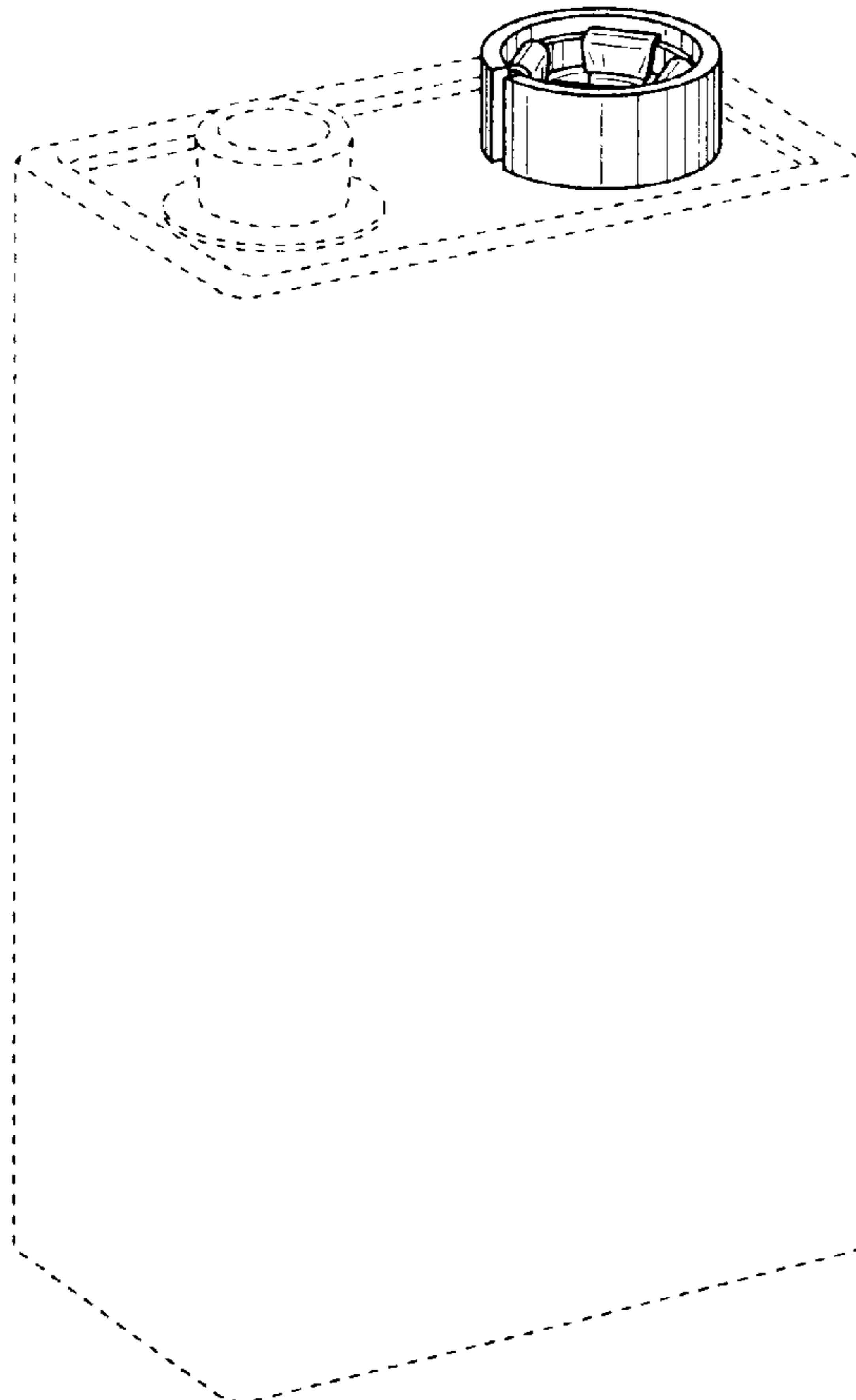

*FIG. 1*

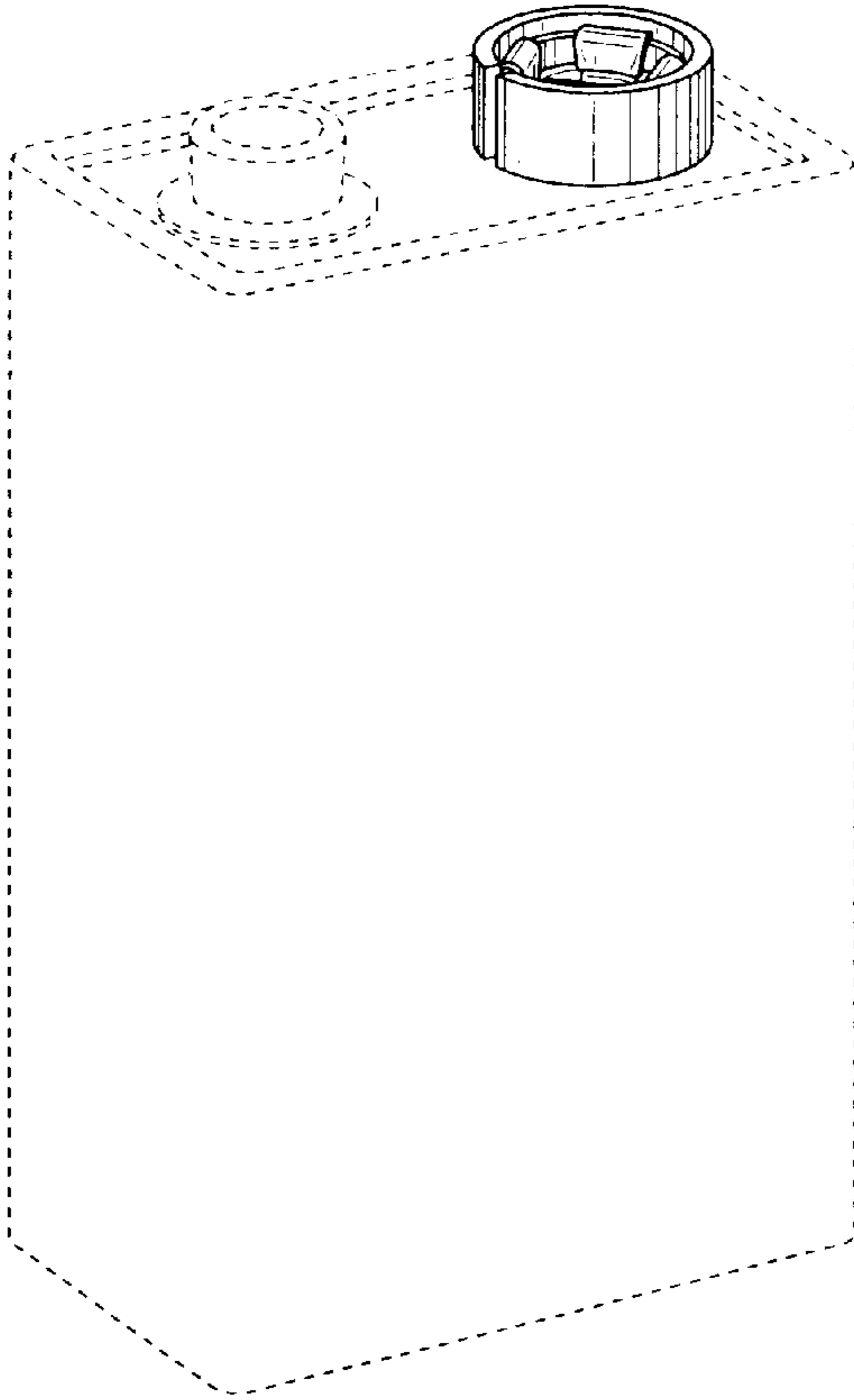

*FIG. 2*

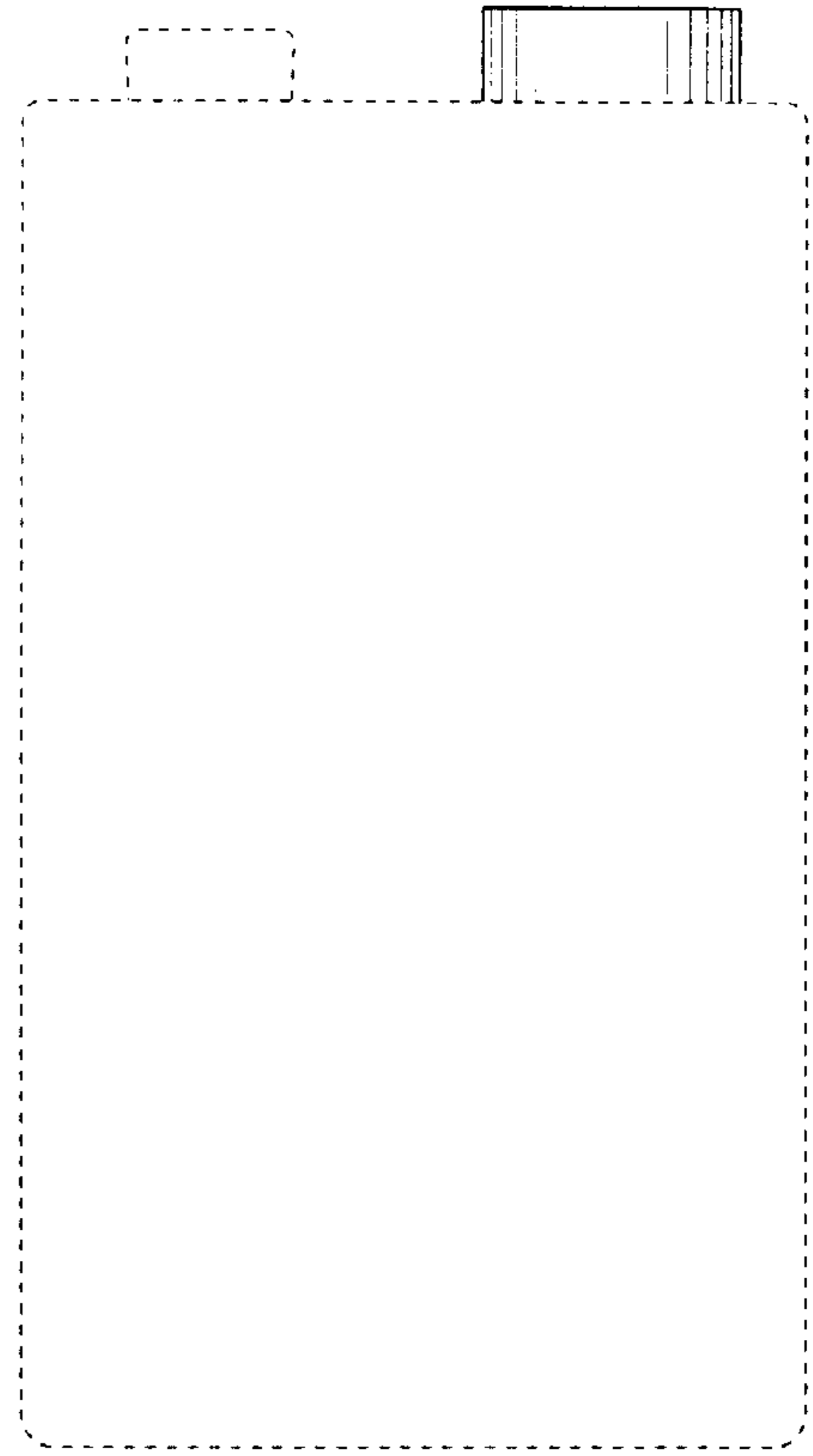

*FIG. 3*

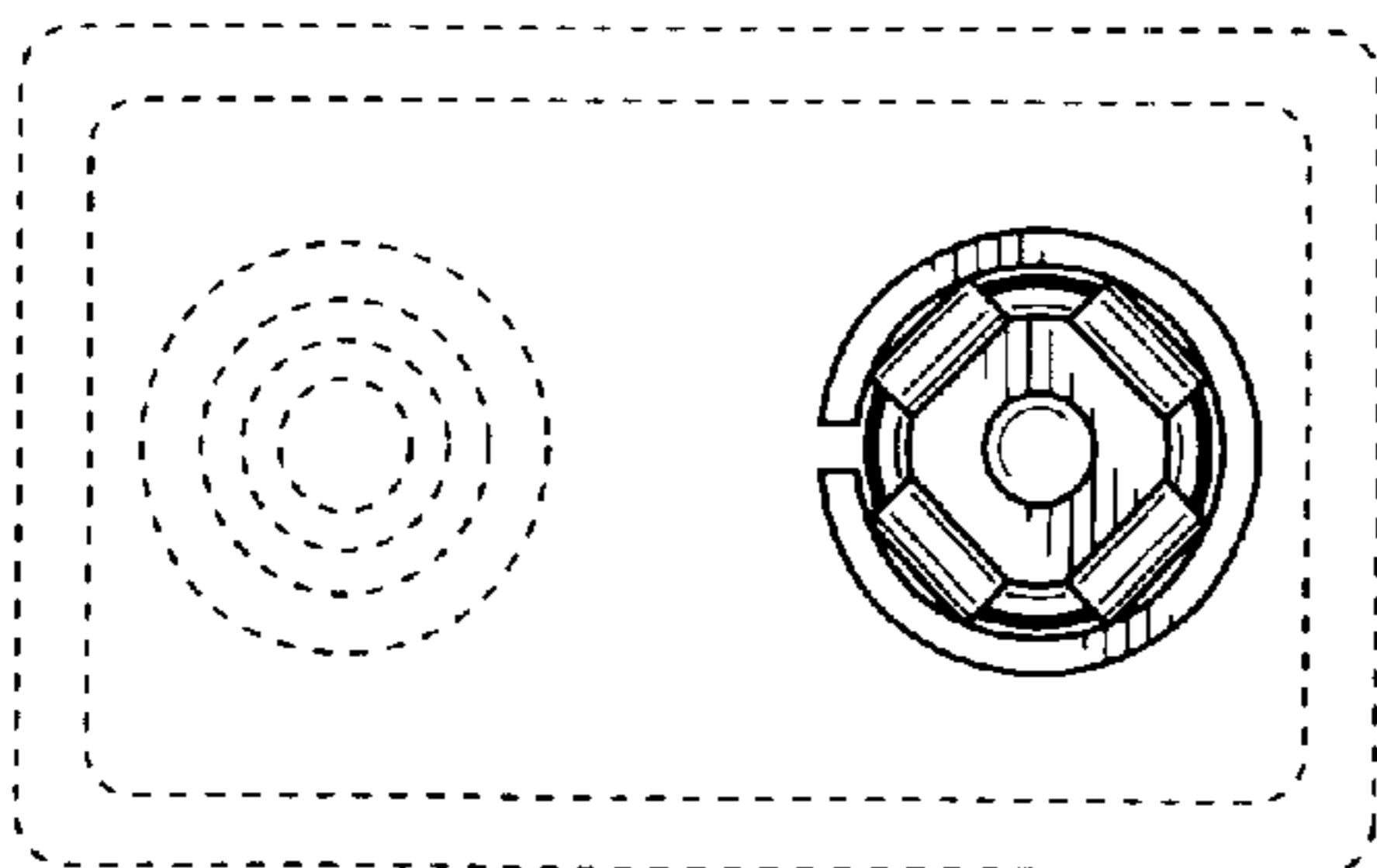

*FIG. 4*

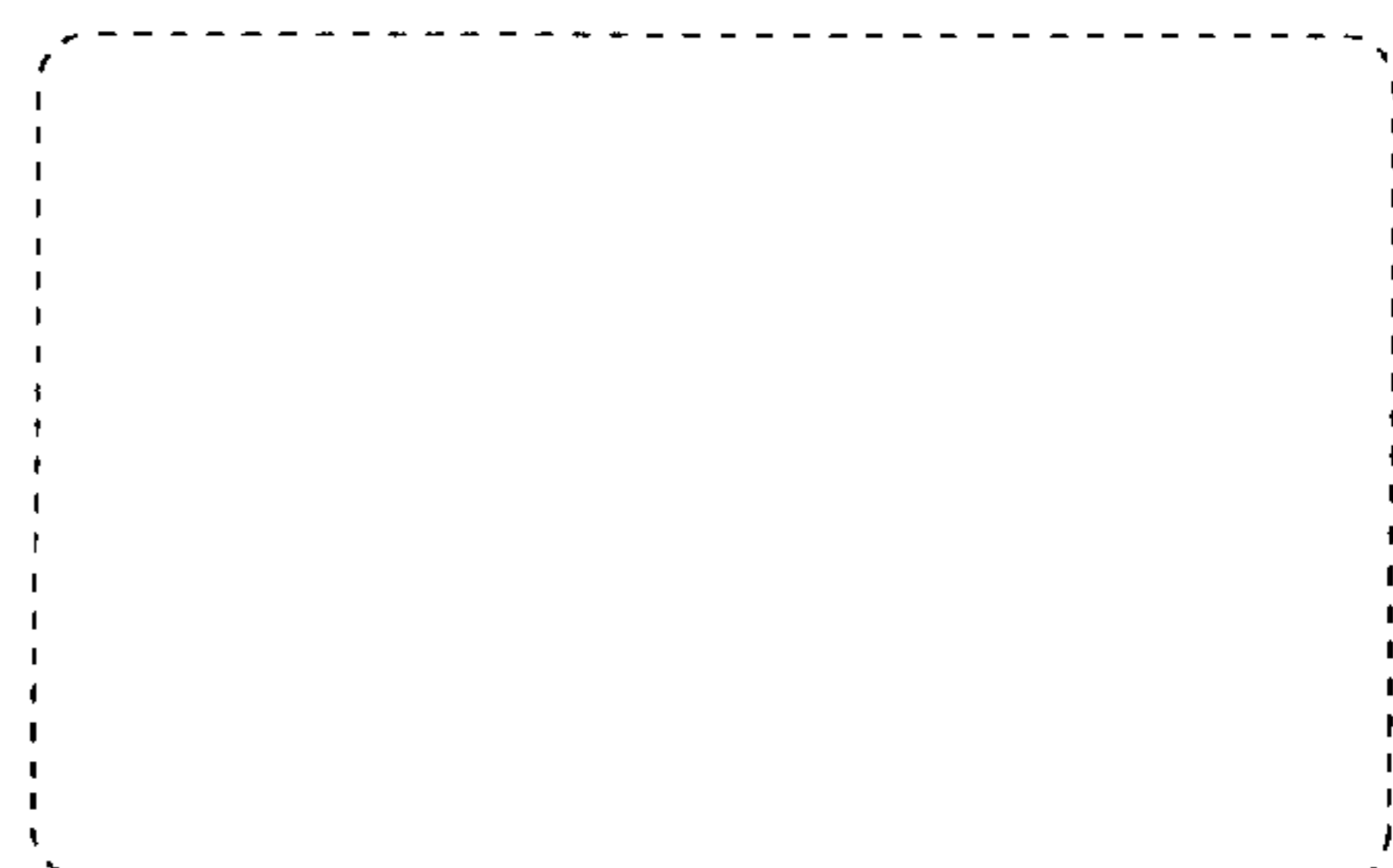

*FIG. 5*

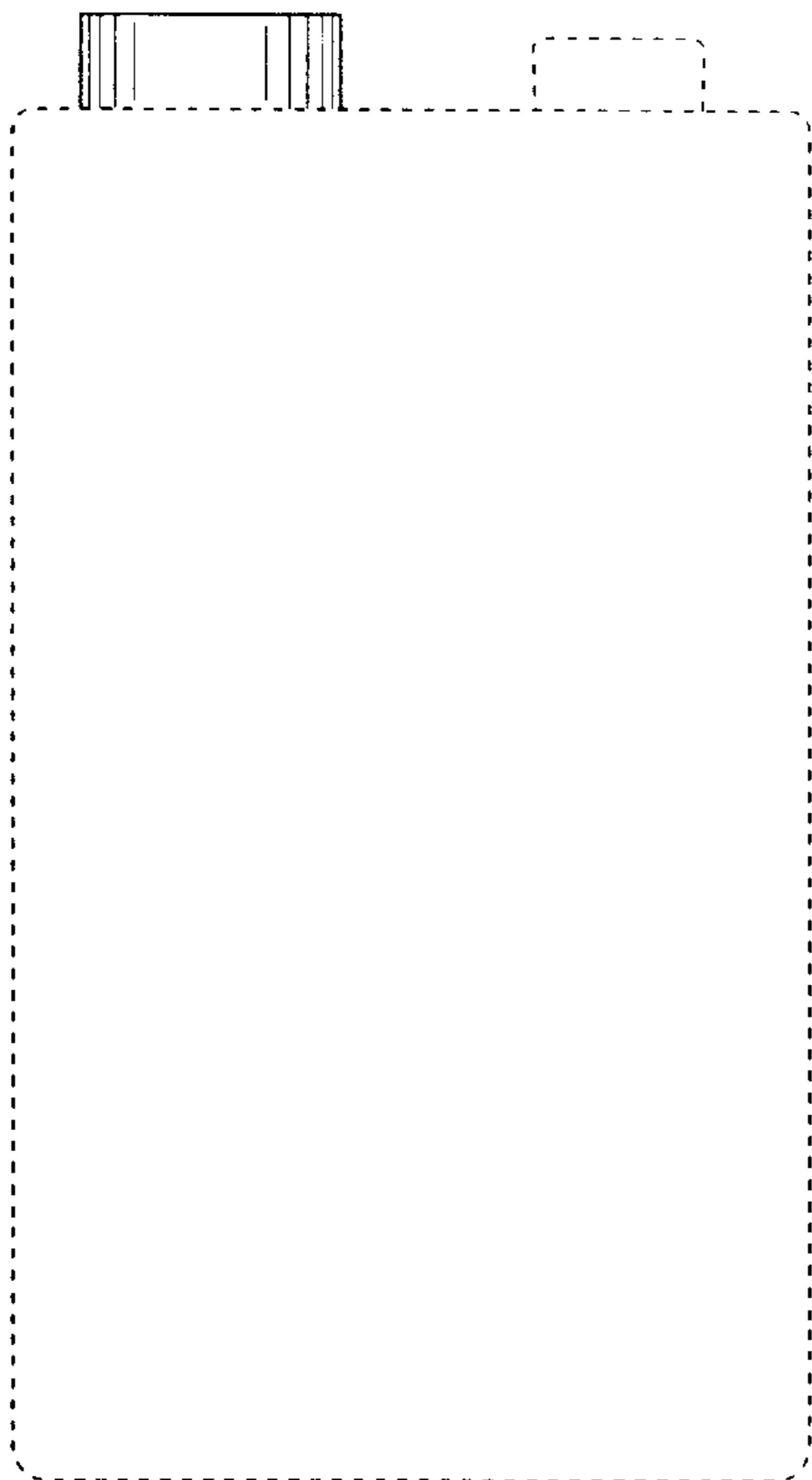

*FIG. 6*

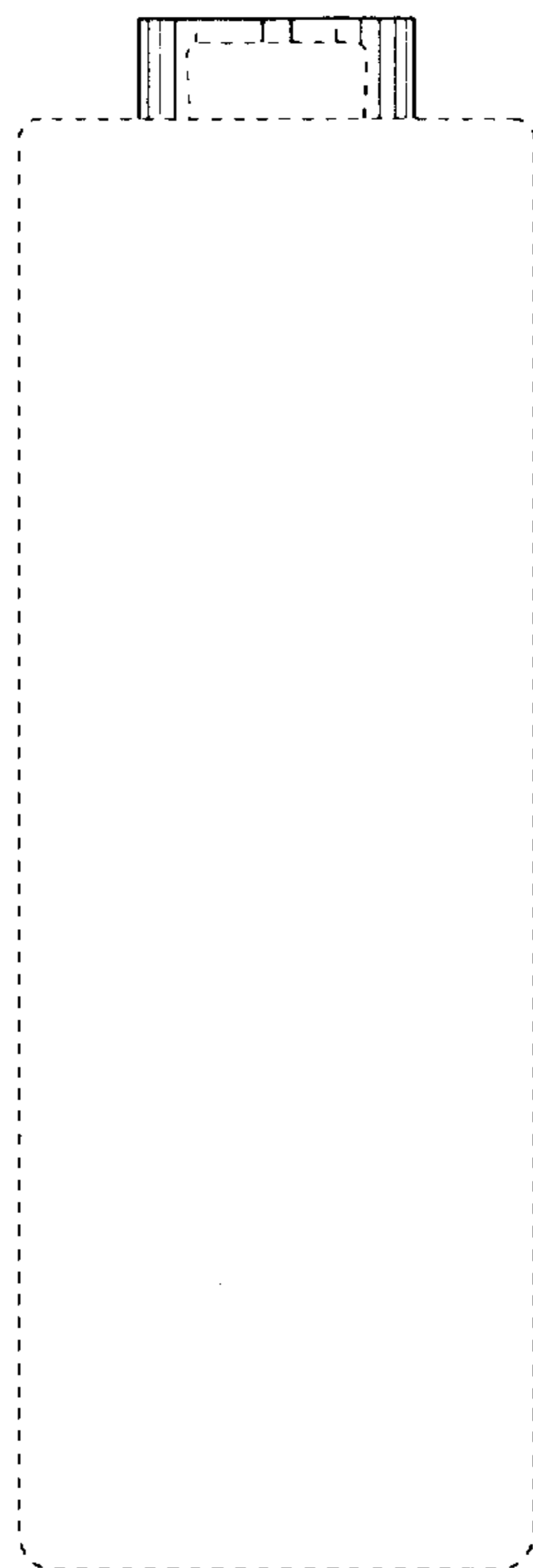

*FIG. 7*

