



US00D472090S

(12) **United States Design Patent**  
**Wing**

(10) **Patent No.:** **US D472,090 S**

(45) **Date of Patent:** **\*\* Mar. 25, 2003**

(54) **PORTABLE POOL CUE HOLDER**

(76) Inventor: **James R. Wing**, 8465 Skokie Blvd.,  
Skokie, IL (US) 60077

(\*\*) Term: **14 Years**

(21) Appl. No.: **29/155,586**

(22) Filed: **Feb. 13, 2002**

(51) **LOC (7) Cl.** ..... **08-08**

(52) **U.S. Cl.** ..... **D6/552**

(58) **Field of Search** ..... D6/552; 211/13.1,  
211/85.7, 34-35, 86.01, 87.01, 89.01, 106.01;  
248/309.1, 312

(56) **References Cited**

**U.S. PATENT DOCUMENTS**

D190,429 S	*	5/1961	Hoagland	.....	D6/552
5,632,386 A	*	5/1997	Gabhart	.....	211/85.7
D440,803 S	*	4/2001	McCormick et al.	.....	D6/552

\* cited by examiner

*Primary Examiner*—Brian N. Vinson  
(74) *Attorney, Agent, or Firm*—Ladas & Parry

(57) **CLAIM**

The ornamental design for a portable pool cue holder, as shown and described.

**DESCRIPTION**

FIG. 1 is a perspective view of a portable pool cue holder showing my new design;

FIG. 2 is a bottom plan view thereof;

FIG. 3 is a top plan view thereof;

FIG. 4 is a front side plan view thereof;

FIG. 5 is a back side plan view thereof;

FIG. 6 is a left side view thereof, when referencing the front side shown in FIG. 4; and,

FIG. 7 is a right side view thereof, when referencing the front side shown in FIG. 4.

**1 Claim, 2 Drawing Sheets**

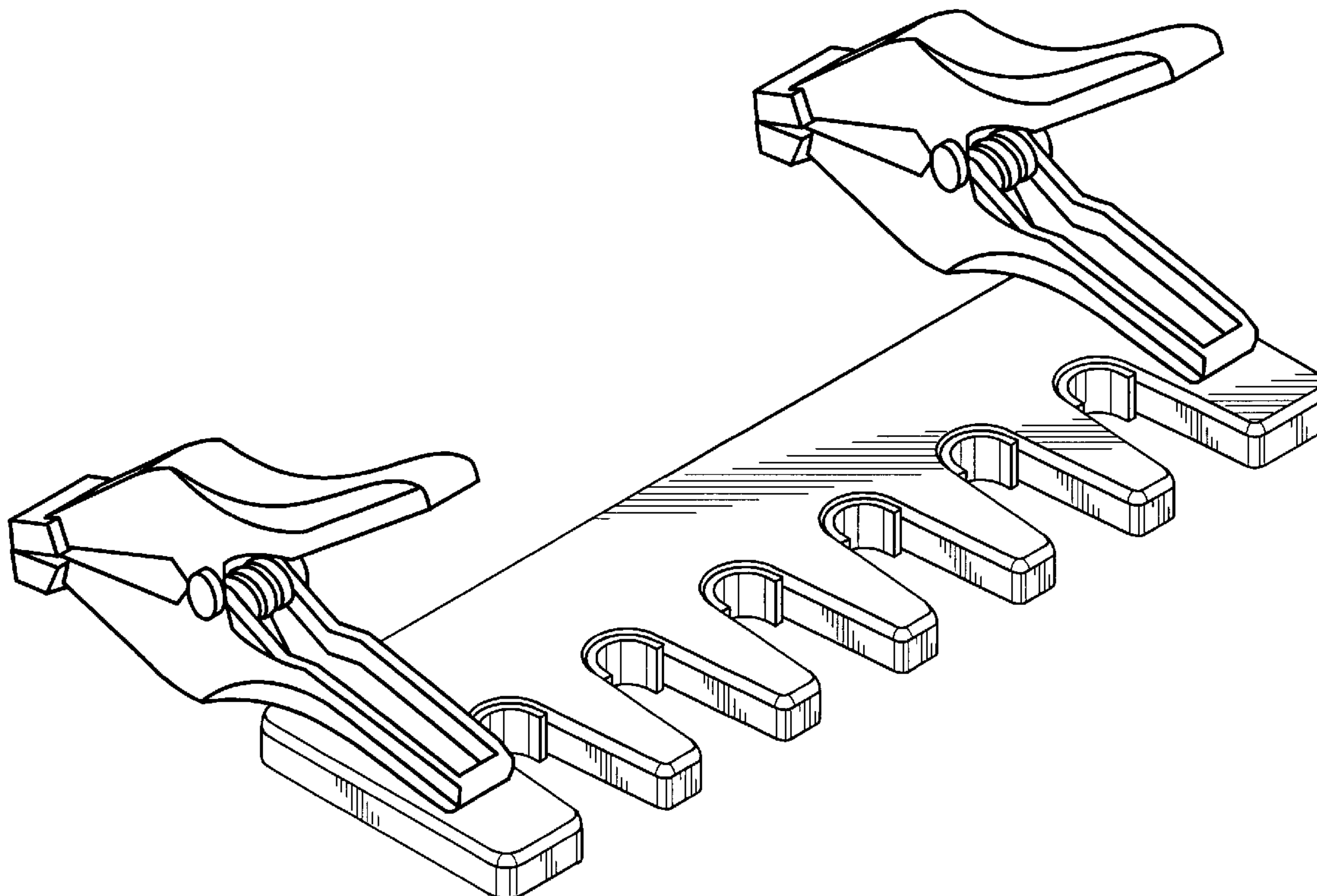

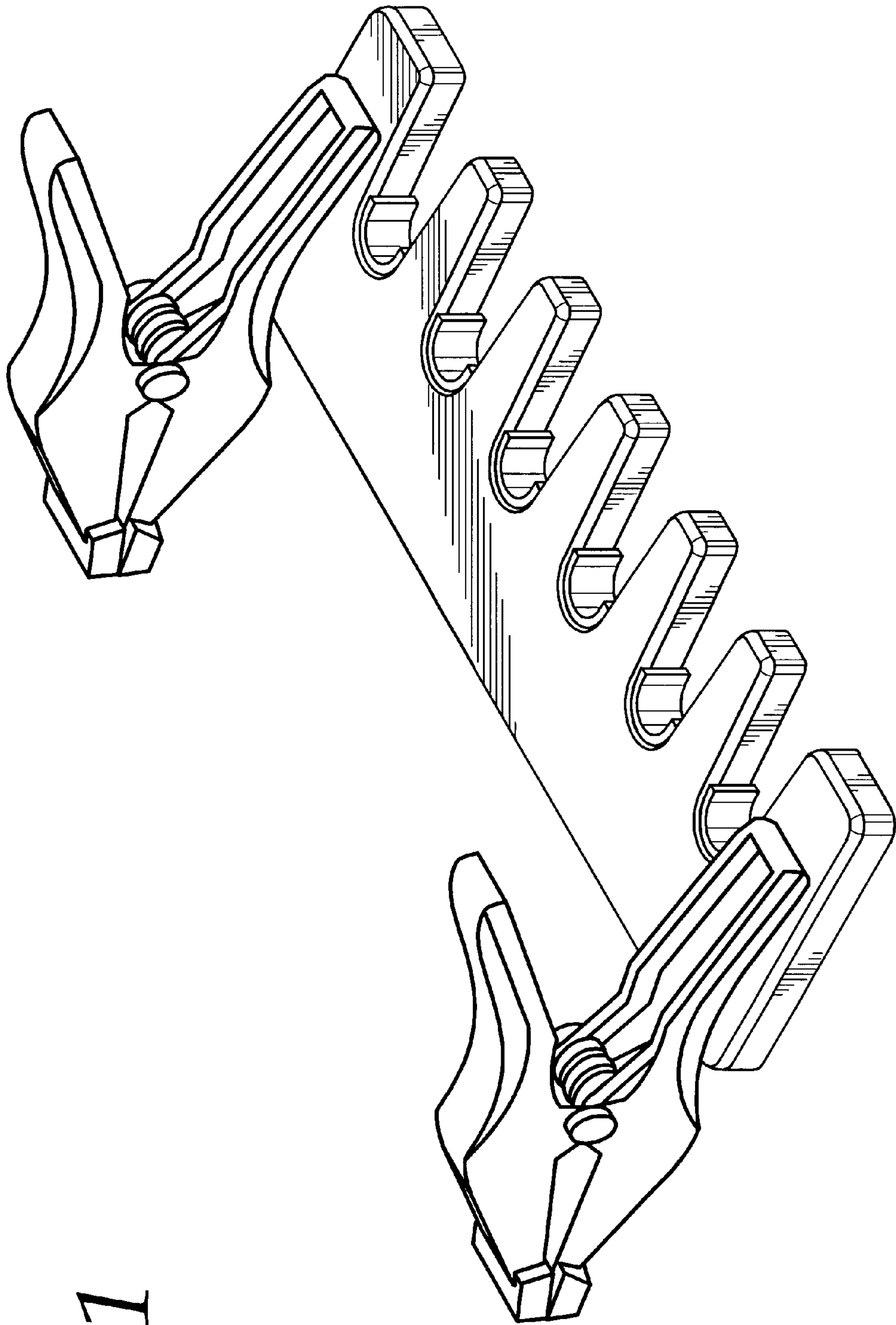
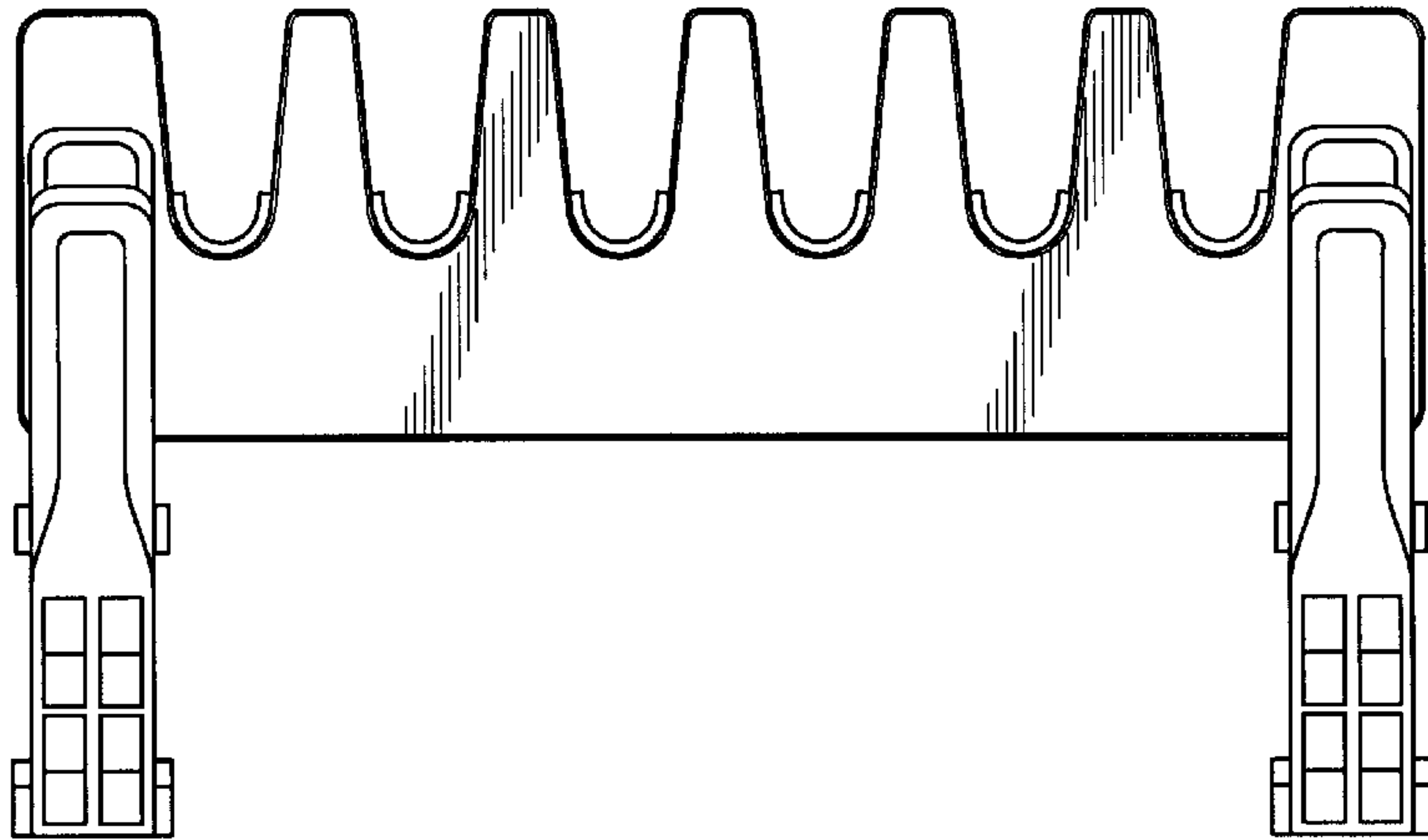
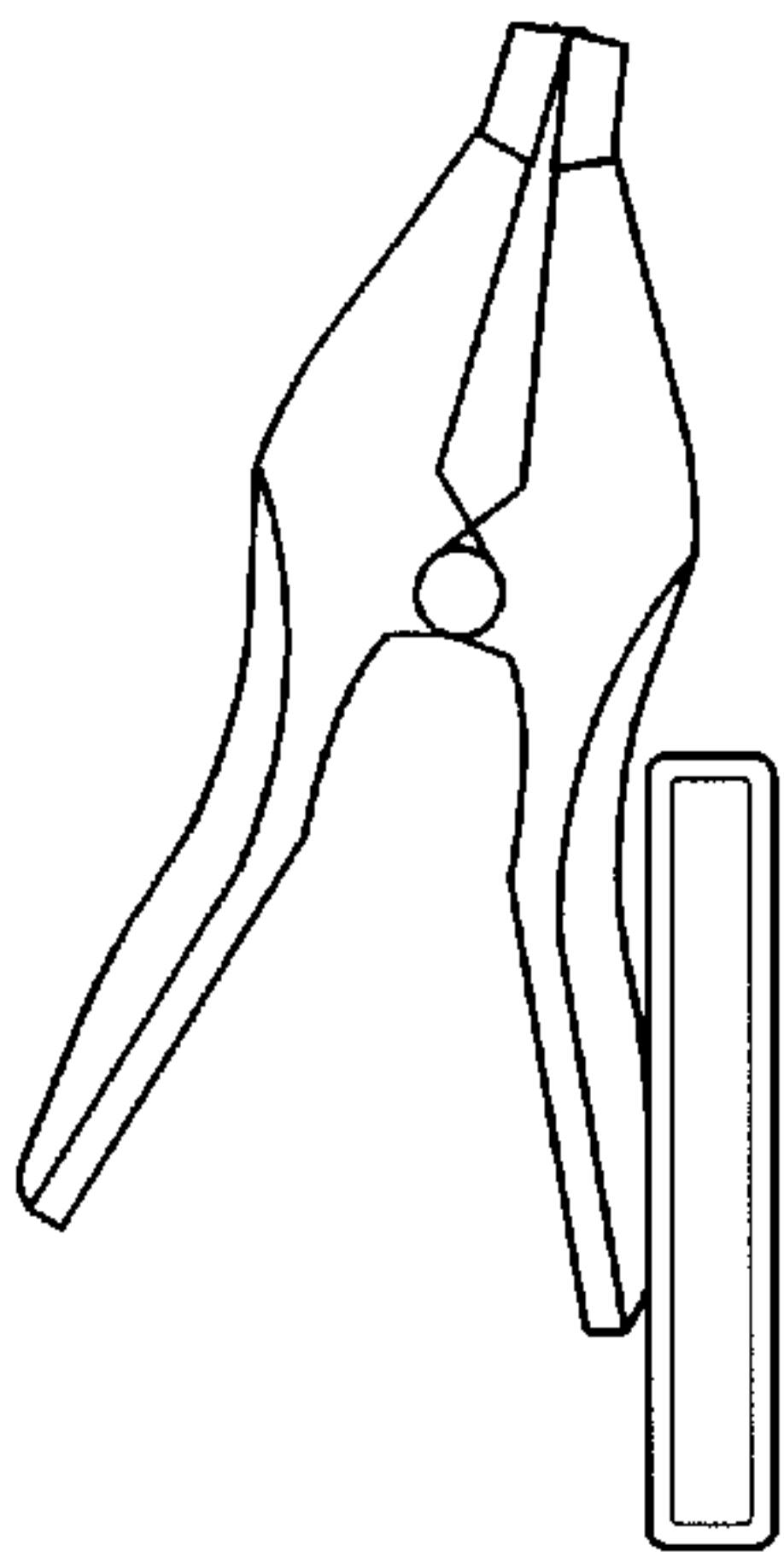

Fig. 1

*Fig. 2*



*Fig. 6*



*Fig. 3*

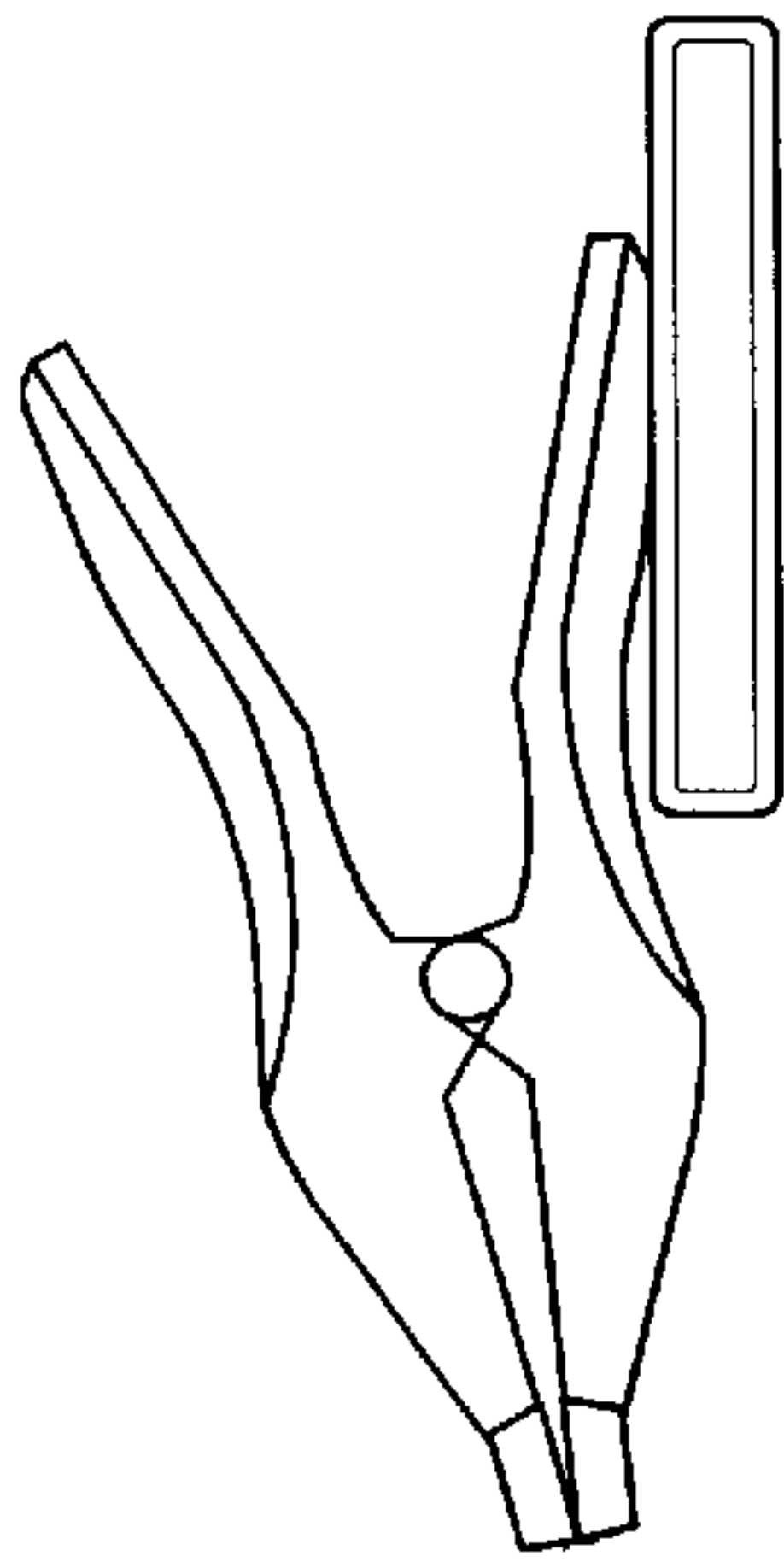
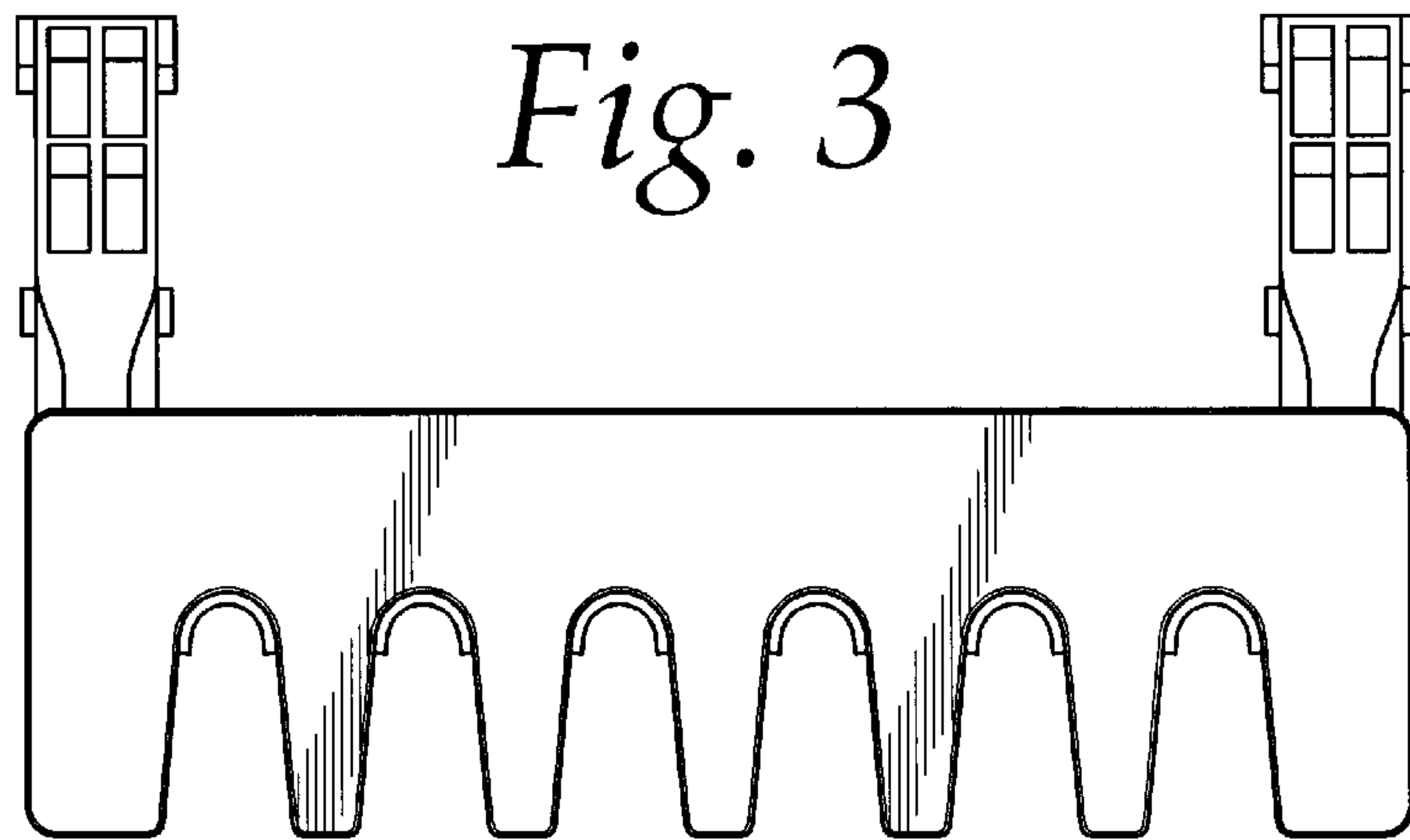

*Fig. 4*

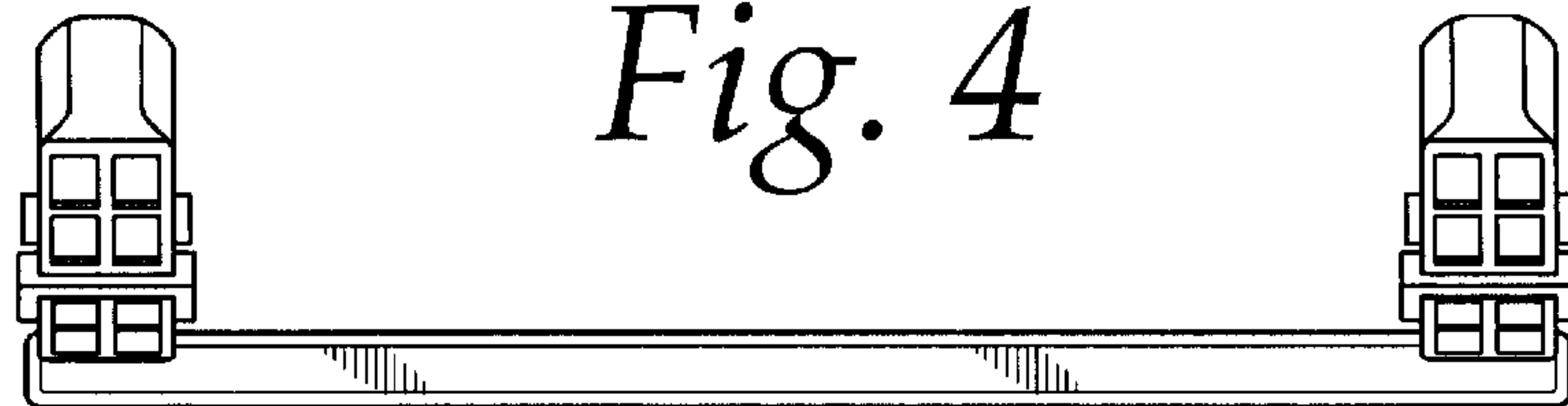

*Fig. 7*

*Fig. 5*

