



US00D472024S

(12) **United States Design Patent**  
**Caldwell**

(10) **Patent No.:** **US D472,024 S**

(45) **Date of Patent:** **\*\* Mar. 18, 2003**

(54) **VACUUM ACTUATED CLOTHES-LINT  
SHAVER**

(76) **Inventor:** **Chrissie Caldwell**, 2300-27 Lee Valley  
Road, Espanola, Ontario (CA), P5E  
1N1

(\*\*) **Term:** **14 Years**

(21) **Appl. No.:** **29/153,859**

(22) **Filed:** **Jan. 15, 2002**

(51) **LOC (7) Cl.** ..... **15-05**

(52) **U.S. Cl.** ..... **D32/32**

(58) **Field of Search** ..... D32/17-25, 31-34;  
15/28, 87, 246.2, 256.52, 327.6, 327.7,  
347, 415.1, 345; D4/119-120, 102; D28/50;  
30/41, 133, 206

(56) **References Cited**

**U.S. PATENT DOCUMENTS**

2,908,933	A	*	10/1959	Todd, Jr. et al.	.....	15/415.1	X
2,980,994	A	*	4/1961	Stachon	.....	30/133	
D200,092	S	*	1/1965	Polatchek	.....	D32/18	
D290,551	S	*	6/1987	Huen	.....	D4/102	
4,788,769	A	*	12/1988	Maruyama	.....	30/133	
D301,177	S	*	5/1989	Bischoffshausen	.....	D32/31	
4,899,442	A	*	2/1990	Horii et al.	.....	30/133	
D307,957	S	*	5/1990	Mockovak	.....	D28/50	
4,985,999	A	*	1/1991	Iwasaki et al.	.....	30/206	

\* cited by examiner

*Primary Examiner*—Louis S. Zarfaz  
*Assistant Examiner*—Robert A. Delehanty  
(74) *Attorney, Agent, or Firm*—Mike M. Gauthier

(57) **CLAIM**

I claim the ornamental design for the vacuum actuated clothes-lint shaver, as shown and described.

**DESCRIPTION**

The present design relates to a clothes-lint shaver adapted to frictionally and releasably attach to a conventional vacuum cleaner hose end wherein the central body portion contains an impeller rotably connected to the shaving blades of the clothes-contacting portion through which a flow of air created by a vacuum cleaner propels the impeller.

FIG. 1 is a perspective view from above of the vacuum actuated clothes-lint shaver of the present design.

FIG. 2 is a right side cross-section view taken along lines 2—2 of FIG. 5 of the vacuum actuated clothes-lint shaver of the present design.

FIG. 3 is a right side elevation view of the vacuum actuated clothes-lint shaver of the present design.

FIG. 4 is a left side elevation view of the vacuum actuated clothes-lint shaver of the present design.

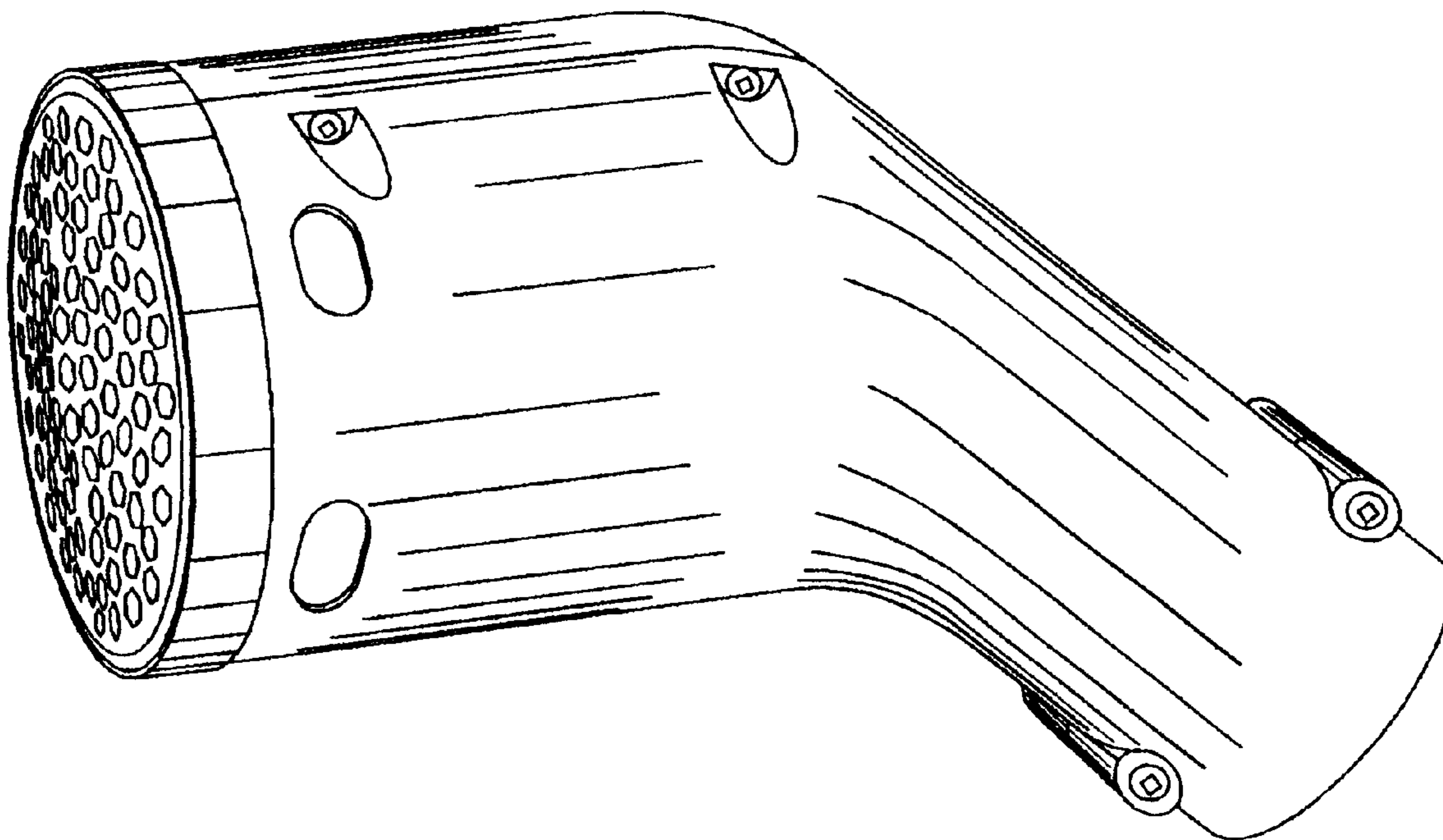
FIG. 5 is a top plan view of the vacuum actuated clothes-lint shaver of the present design.

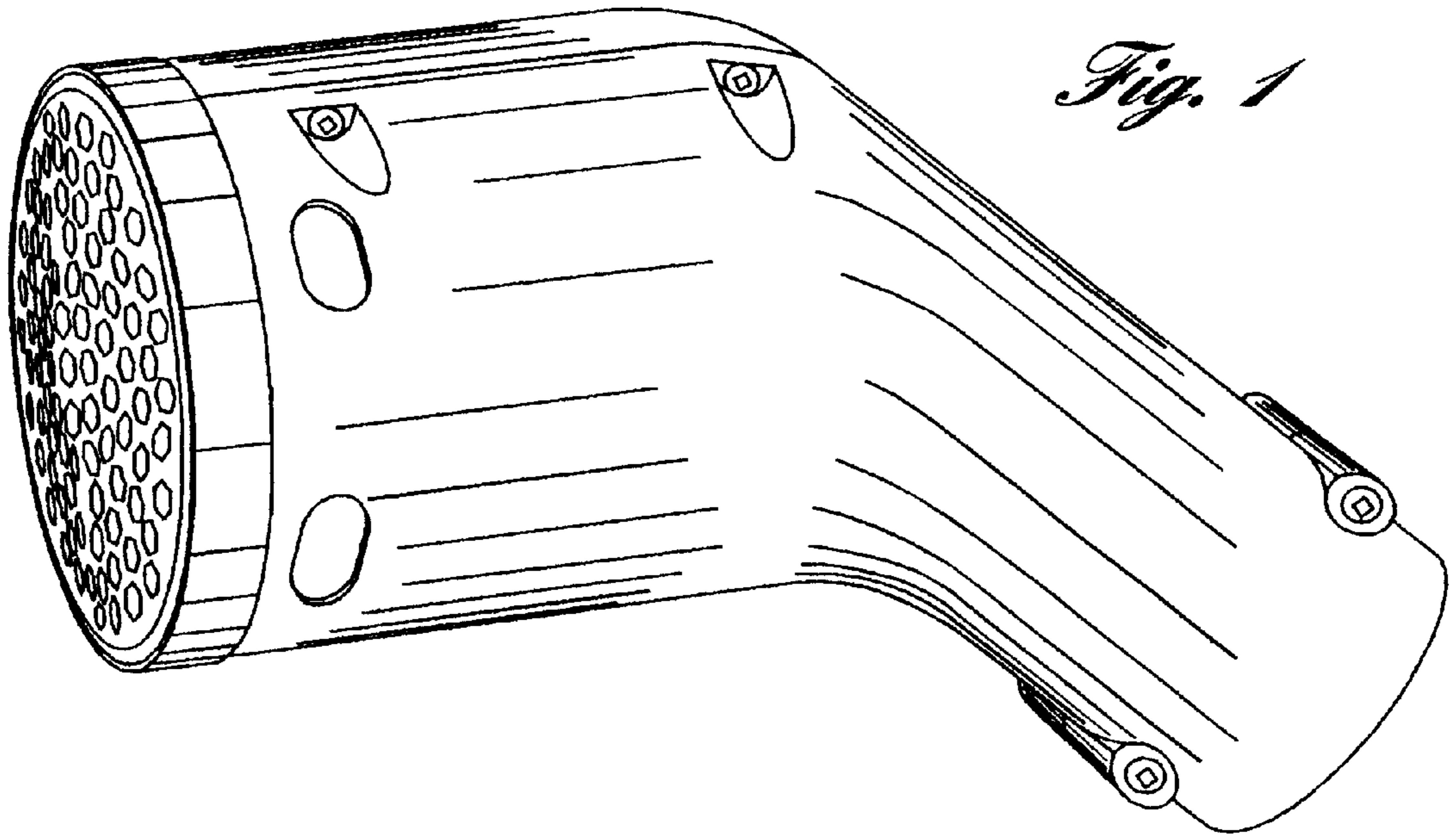
FIG. 6 is a bottom plan view of the vacuum actuated clothes-lint shaver of the present design.

FIG. 7 is a rear elevation view of the vacuum actuated clothes-lint shaver of the present design; and,

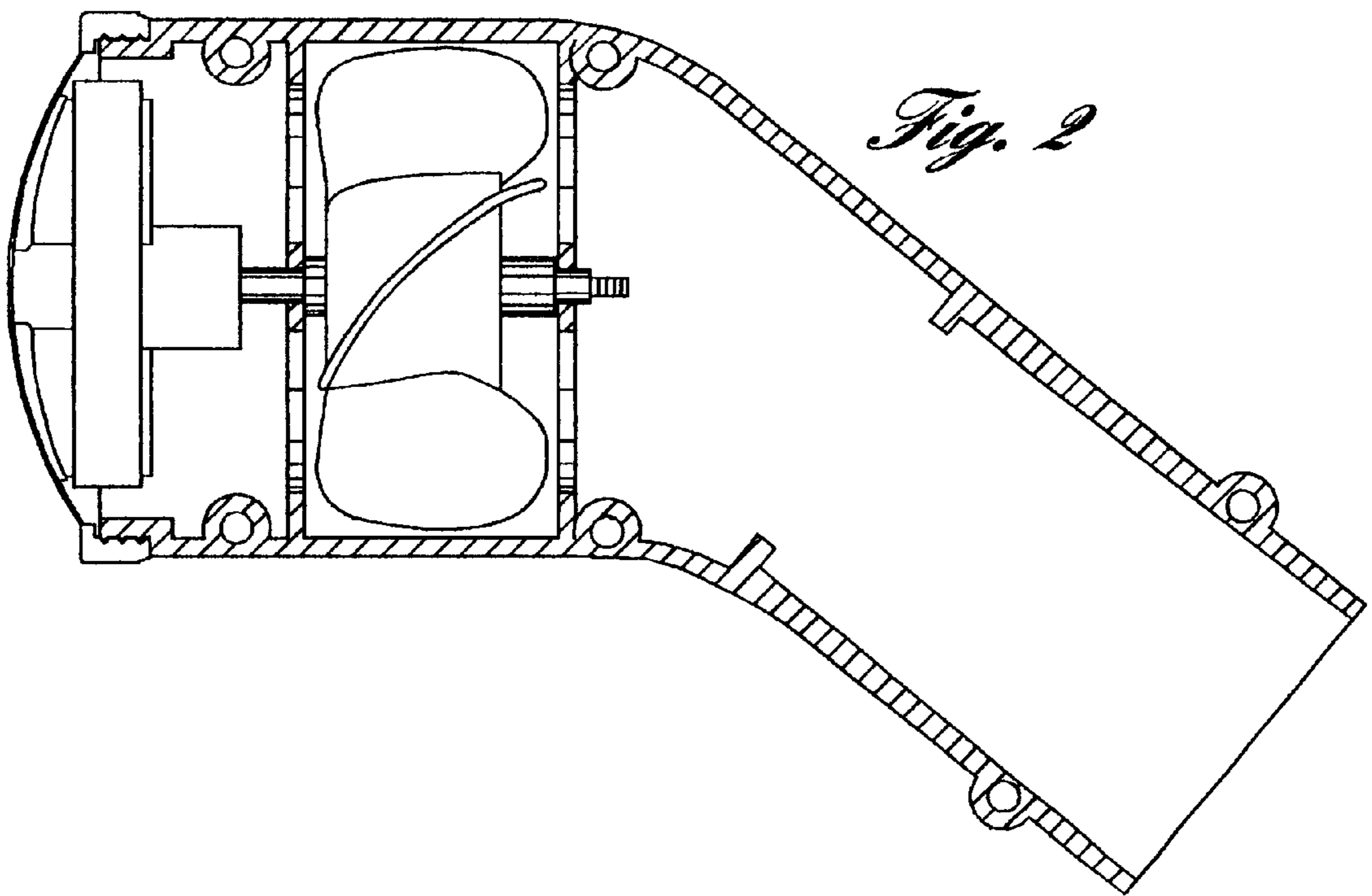
FIG. 8 is a front elevation view of the vacuum actuated clothes-lint shaver of the present design.

**1 Claim, 4 Drawing Sheets**

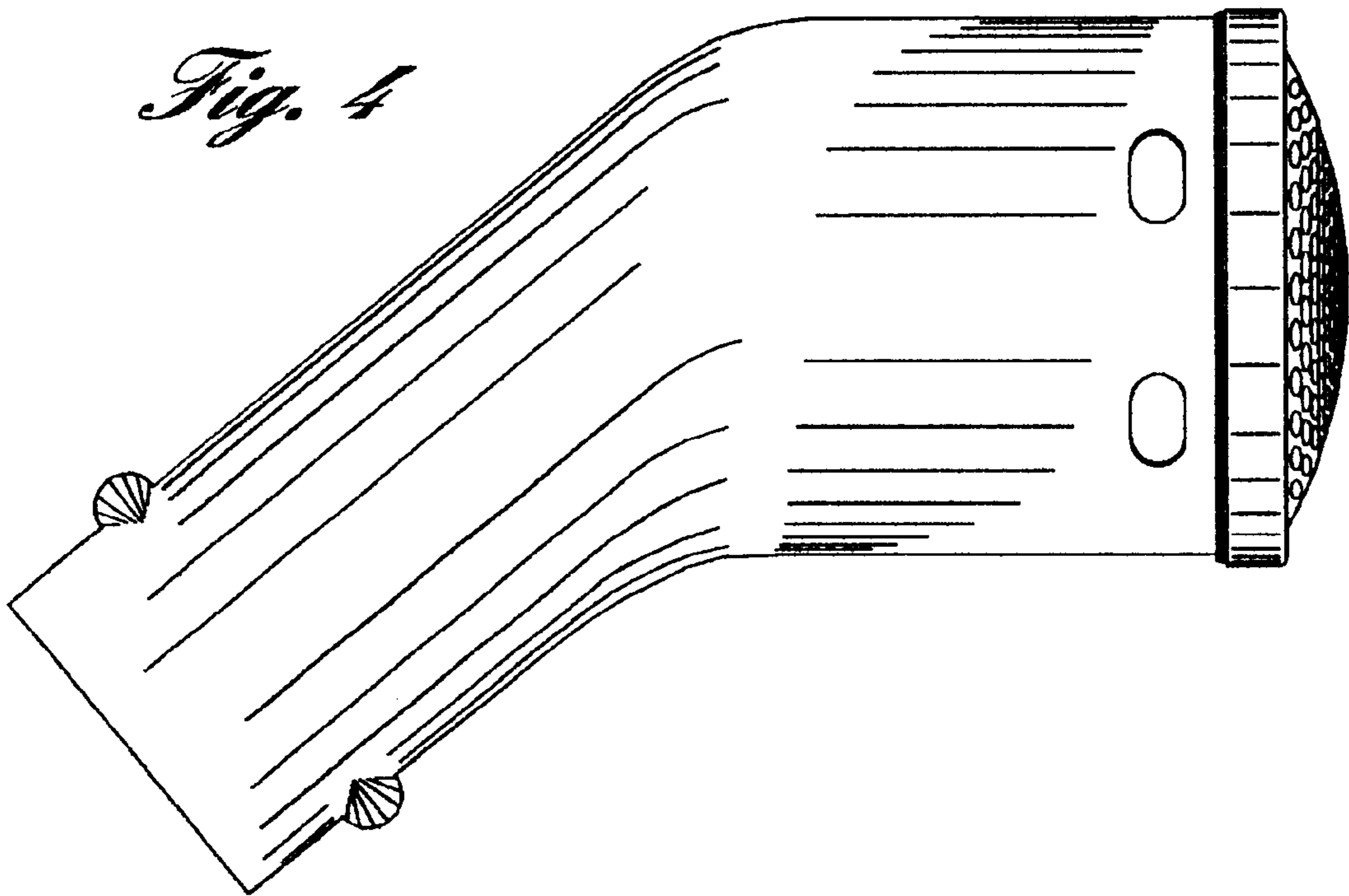
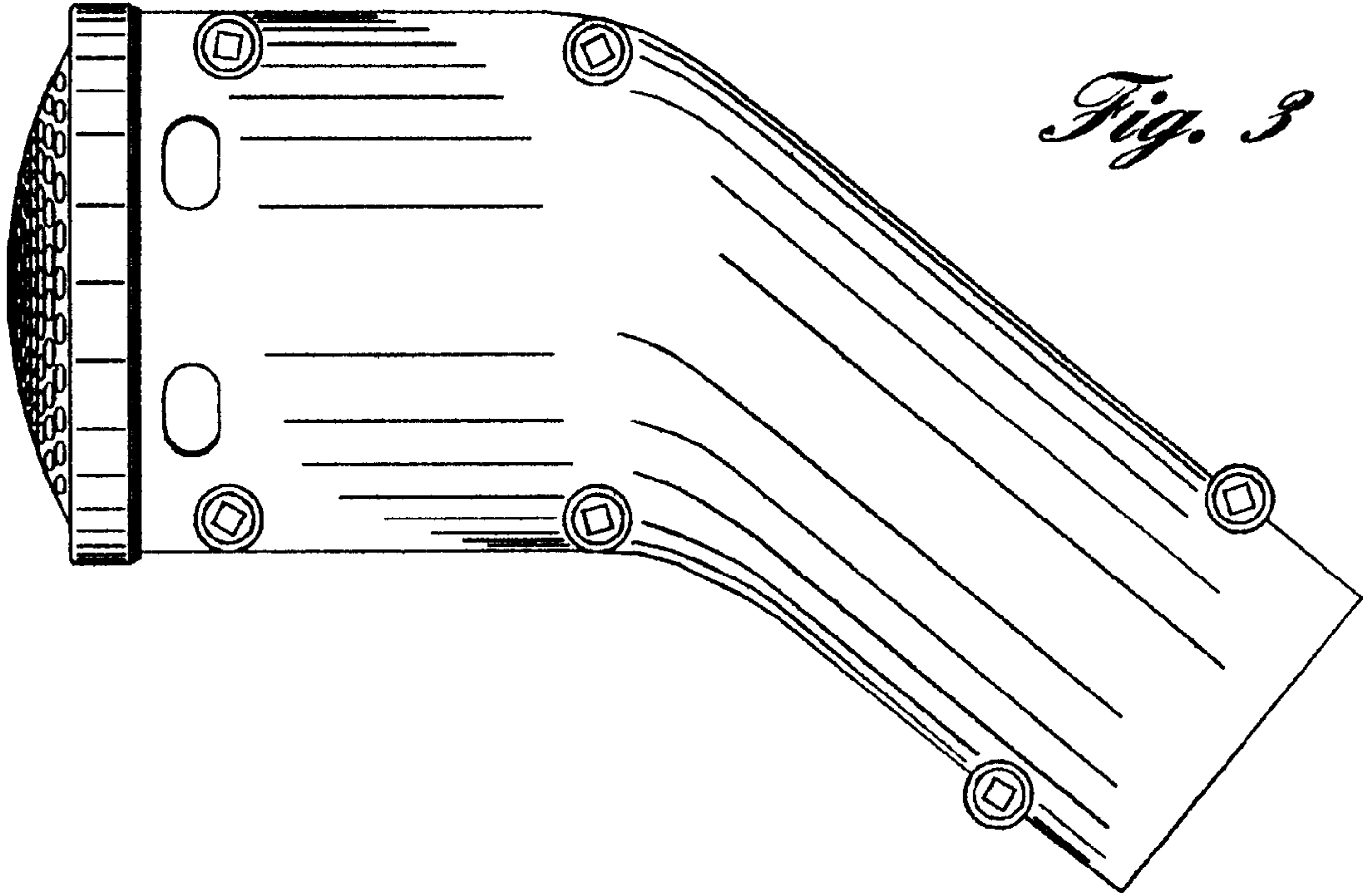




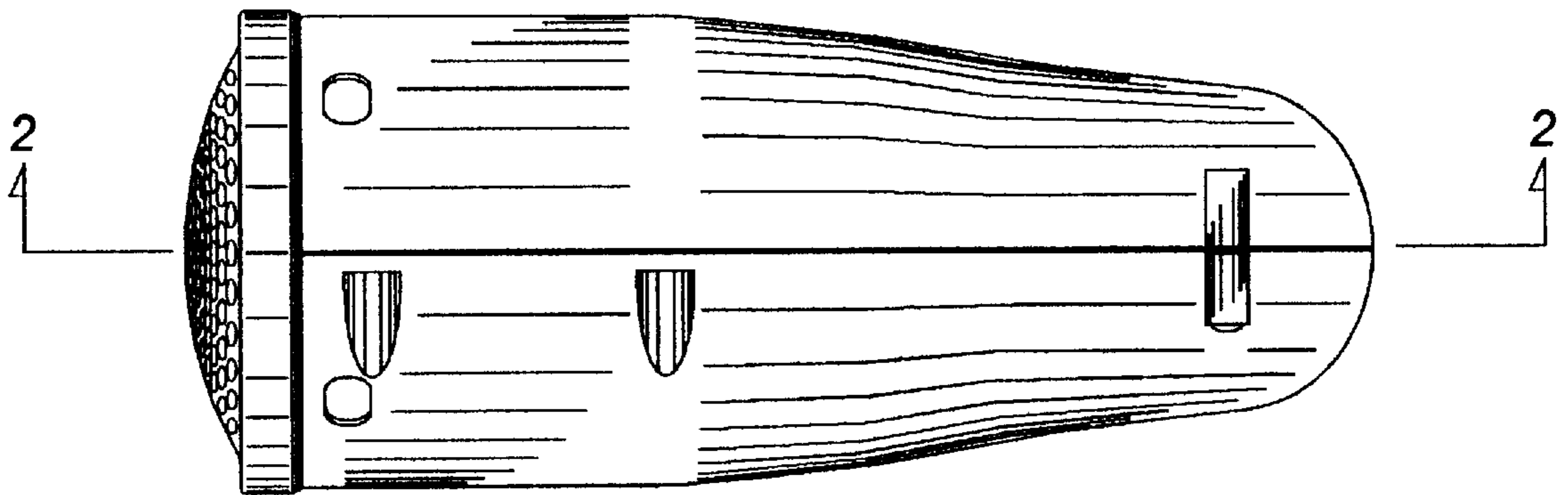
*Fig. 1*



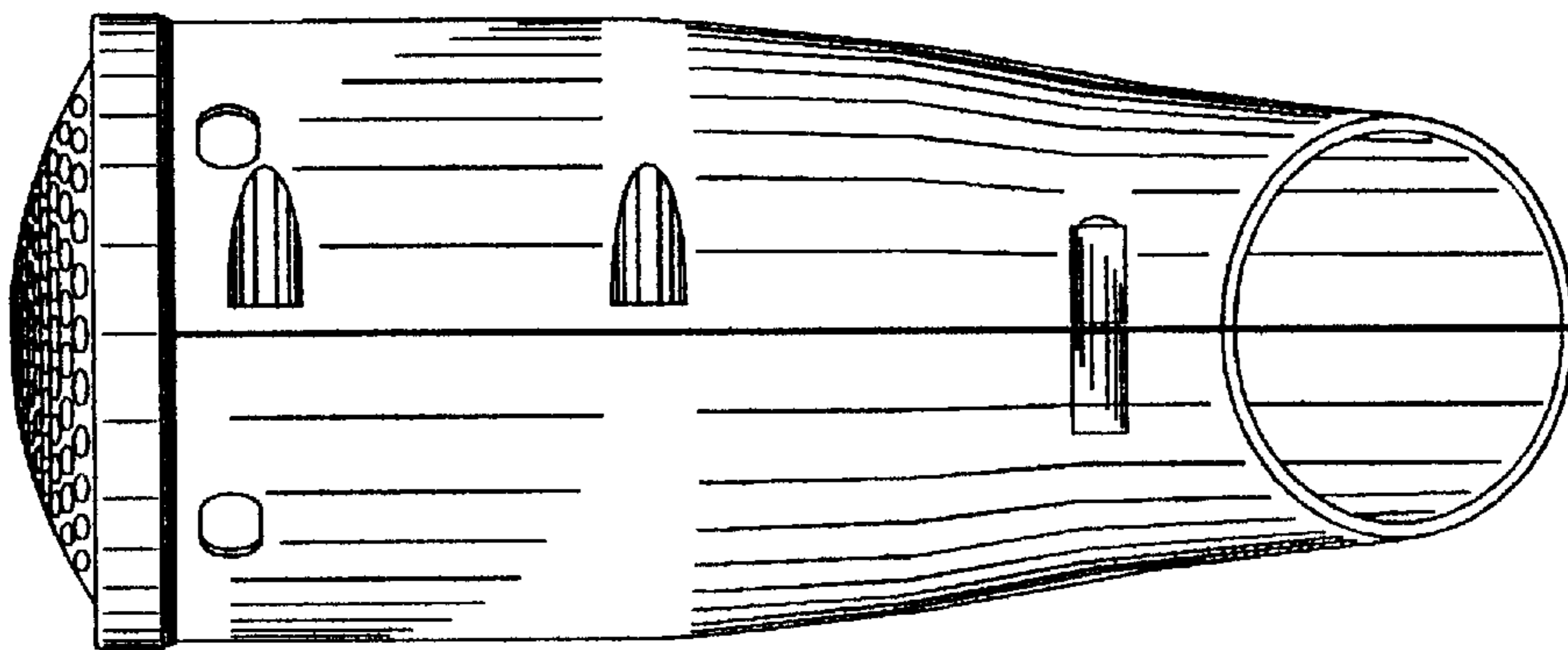
*Fig. 2*



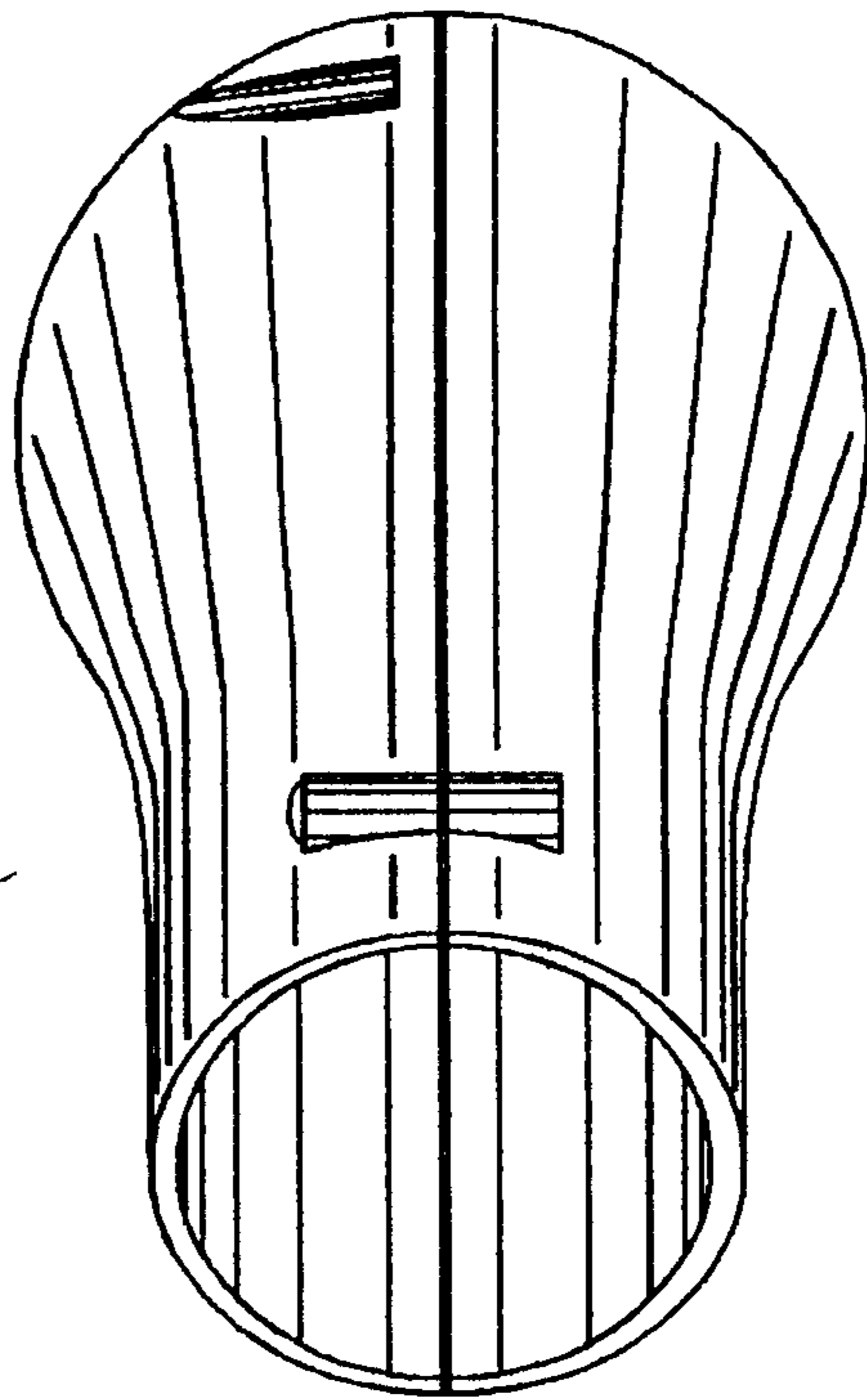
*Fig. 5*



*Fig. 6*



*Fig. 7*



*Fig. 8*

