



US00D471838S

(12) **United States Design Patent**
Chia et al.

(10) **Patent No.:** **US D471,838 S**

(45) **Date of Patent:** **** Mar. 18, 2003**

(54) **JEWELRY COMPONENT**

(76) Inventors: **Meang Chia**, 412 W. 6th St., Suite 1104, Los Angeles, CA (US) 90014; **Cheo Chia**, 412 W. 6th St., Suite 1104, Los Angeles, CA (US) 90014; **Huy Kim Chia**, 412 W. 6th St., Suite 1104, Los Angeles, CA (US) 90014

(**) **Term:** **14 Years**

(21) **Appl. No.:** **29/140,294**

(22) **Filed:** **Apr. 16, 2001**

Related U.S. Application Data

(62) Division of application No. 29/120,104, filed on Mar. 10, 2000, now Pat. No. Des. 453,122, which is a continuation-in-part of application No. 29/110,327, filed on Sep. 3, 1999, which is a continuation-in-part of application No. 29/098,058, filed on Dec. 21, 1998, now Pat. No. Des. 418,445, which is a division of application No. 29/070,204, filed on May 7, 1997, now Pat. No. Des. 406,247.

(51) **LOC (7) Cl.** **11-01**

(52) **U.S. Cl.** **D11/93**

(58) **Field of Search** D11/1-26, 35, D11/40-48, 56, 75-77, 79-81, 89-94, 103, 59; 63/1.1, 32, 2, 15, 27, 4, 13, 20, 23, 26, DIG. 6; 59/80

(56) **References Cited**

U.S. PATENT DOCUMENTS

D12,579 S	11/1881	Reynolds
D14,818 S	2/1884	Merril
439,139 A	10/1890	Gaynor
569,495 A	10/1896	Gunther
572,237 A	12/1896	Adams
D32,439 S	4/1900	Gay
D32,649 S	5/1900	McCutchen et al.
795,109 A	7/1905	Dover
813,084 A	2/1906	Dover
851,078 A	4/1907	Dunn
1,001,583 A	8/1911	Fairbrother
1,024,048 A	4/1912	Abel
D42,514 S	5/1912	Meyers

D42,643 S	6/1912	Meyers
1,153,362 A	9/1915	Wacha
D48,950 S	4/1916	Rosenberger
1,189,497 A	7/1916	Schwartzman
1,344,365 A	6/1920	Wachenheimer
D55,597 S	7/1920	Felger
D56,605 S	11/1920	Grasmuk
D56,607 S	11/1920	Grasmuk
1,410,366 A	3/1922	Buchman
1,433,521 A	10/1922	Albanese
1,443,654 A	1/1923	Schmidt
1,467,468 A	9/1923	Blanchard
1,556,465 A	10/1925	Wendel
1,570,932 A	1/1926	Anderson et al.
1,589,423 A	6/1926	Payton
D76,388 S	* 9/1928	Granat D11/38
D76,664 S	10/1928	Chase
D77,434 S	1/1929	Rice
1,701,610 A	2/1929	Forstner
1,710,660 A	4/1929	Guyot
D84,213 S	5/1931	Speidel
1,842,427 A	1/1932	Sammartino
1,854,958 A	4/1932	Santosuosso
1,892,738 A	1/1933	Schnarr
1,981,696 A	11/1934	Harper
D110,568 S	7/1938	Garfinkel
D117,577 S	11/1939	Sand
D119,286 S	3/1940	Somers
2,273,227 A	2/1942	Simmons
D131,750 S	3/1942	Hobe
D131,847 S	3/1942	Hobe
D143,583 S	1/1946	Feingold
D143,588 S	1/1946	Grun
D143,750 S	2/1946	Philippe
D144,901 S	6/1946	Braunstein
D145,426 S	8/1946	Braunstein
D146,779 S	5/1947	Slater
D151,904 S	11/1948	Katz
D155,873 S	11/1949	Chernow
D156,650 S	12/1949	Pearce et al.
D156,744 S	1/1950	Kent
D159,528 S	8/1950	Philippe
D159,582 S	8/1950	Boucher
D160,241 S	9/1950	Bardach
2,526,134 A	10/1950	Henry
2,538,090 A	1/1951	Ferragamo
D165,468 S	12/1951	Katz
2,584,207 A	2/1952	Holl
2,634,593 A	4/1953	Moretti

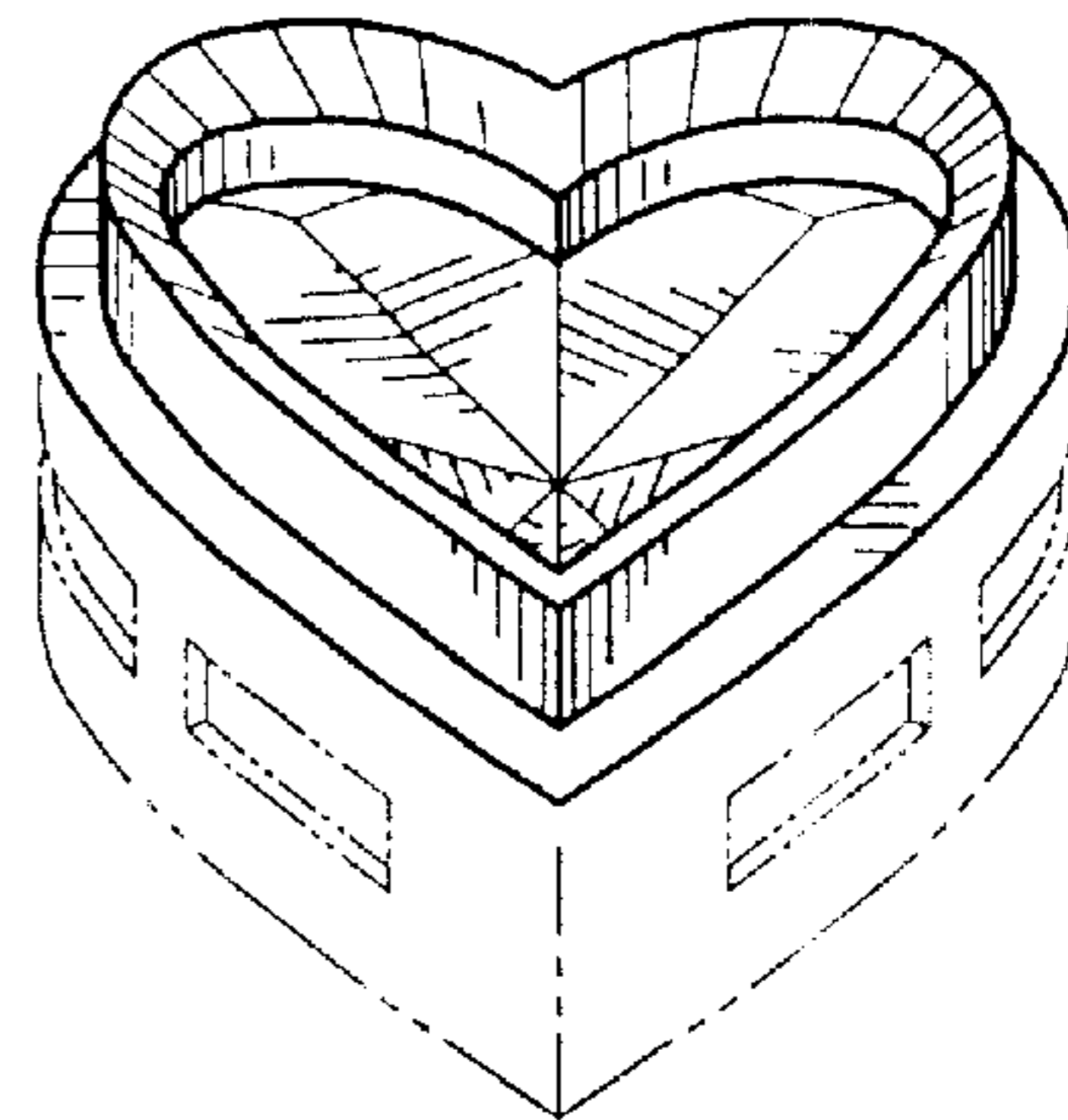
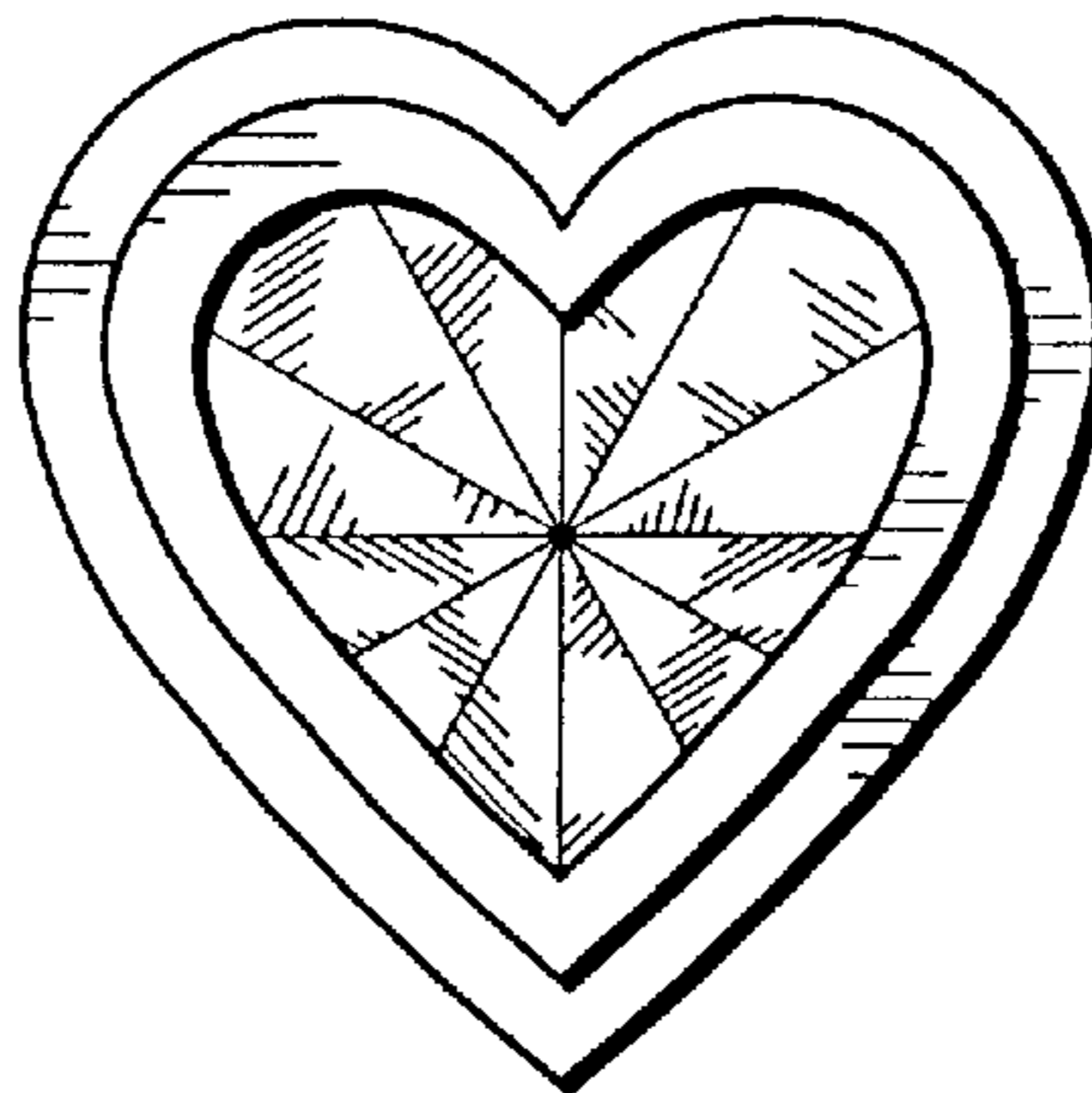
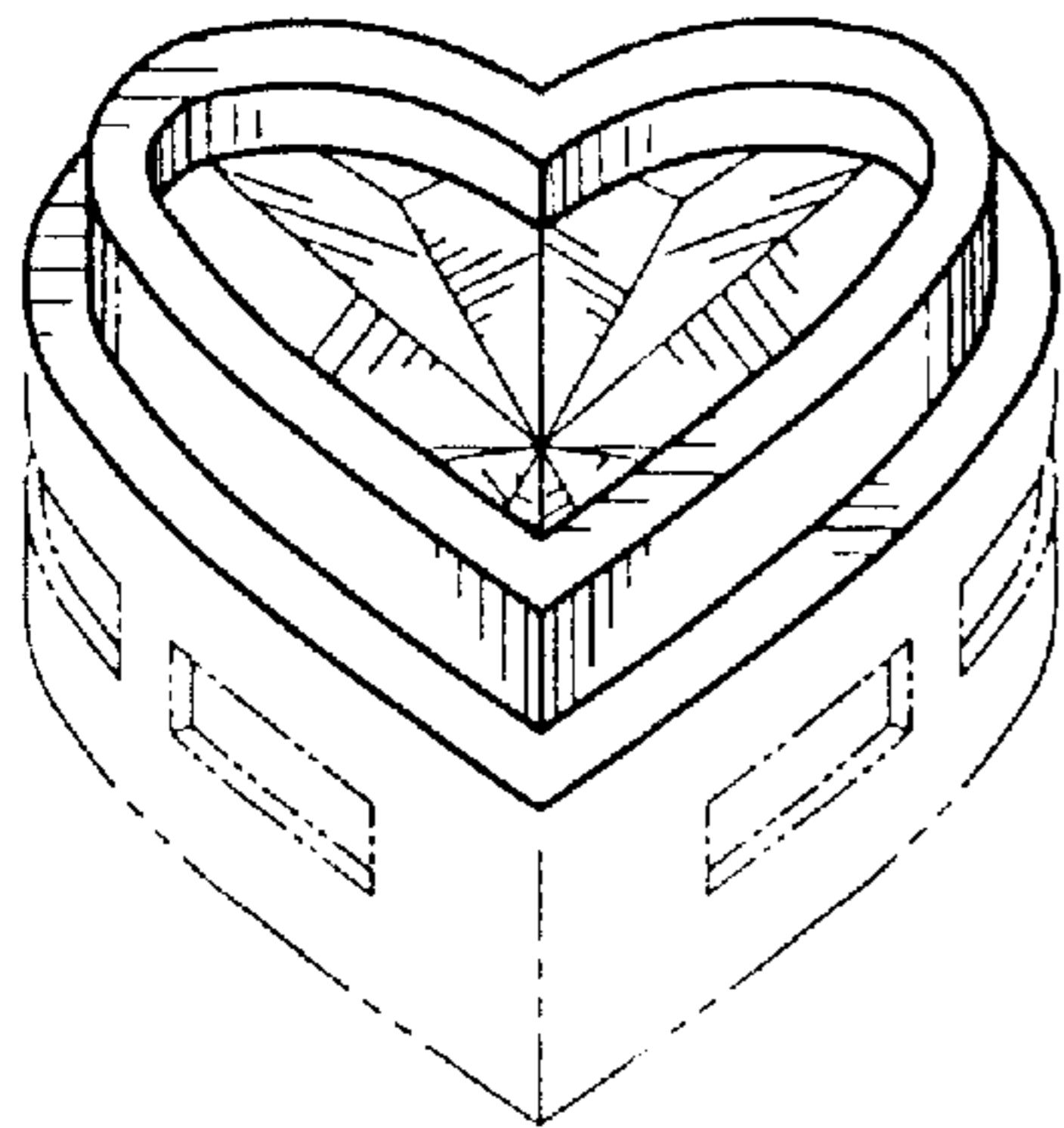

D176,664 S	1/1956	Katz	
2,852,923 A	9/1958	Gamelsky	
D184,930 S	4/1959	Gonicberg	
D186,903 S	12/1959	Hess	
3,025,820 A	3/1962	Rosenthal	
D202,723 S	11/1965	Gaston	
3,670,524 A	6/1972	Korwin	
4,154,282 A	5/1979	Kull	
4,165,574 A	8/1979	Sciotti	
D257,017 S	9/1980	Barr	
D265,639 S	8/1982	Barr	
D266,954 S	11/1982	Gordan	
4,399,910 A	8/1983	Gutentag	
4,488,415 A	12/1984	Jenkins	
D277,466 S	2/1985	Chien	
4,551,993 A	11/1985	Nagahori	
4,566,294 A	1/1986	Brzozowski	
4,763,489 A	8/1988	Strong	
4,781,038 A	11/1988	Branca et al.	
D314,528 S	2/1991	Chia et al.	D11/93
D314,730 S	2/1991	Chia et al.	D11/93
D314,929 S	2/1991	Chia et al.	D11/6
D317,139 S	5/1991	Chia et al.	D11/93
D317,423 S	6/1991	Chia et al.	D11/93
D319,033 S	8/1991	Chia et al.	D11/93
5,056,337 A	10/1991	Nhaissi	
D322,043 S	12/1991	Chia et al.	D11/93
D325,180 S	4/1992	Chia et al.	D11/93
D325,709 S	4/1992	Chia et al.	D11/93
D325,710 S	4/1992	Chia et al.	D11/93
D325,711 S	4/1992	Chia et al.	D11/93
D325,886 S	5/1992	Chia et al.	D11/93
D329,026 S	9/1992	Chia et al.	D11/12
D329,206 S	9/1992	Chia et al.	D11/93
D329,401 S	9/1992	Chia et al.	D11/93
D331,726 S	12/1992	Chia et al.	D11/93
D335,639 S	5/1993	Chia et al.	D11/93
D336,057 S	6/1993	Chia et al.	D11/93
D336,059 S	6/1993	Chia et al.	D11/93
D336,060 S	6/1993	Chia et al.	D11/93
D337,069 S	7/1993	Chia et al.	D11/93
D337,070 S	7/1993	Chia et al.	D11/93
D337,283 S	7/1993	Keshishian	
D337,546 S	7/1993	Keshishian	
D337,547 S	7/1993	Keshishian	
D338,852 S	8/1993	Keshishian	
D348,626 S	* 7/1994	Bedoyan	D11/26
5,355,698 A	10/1994	Edmark	
5,365,754 A	11/1994	Nalbandian	
D379,074 S	5/1997	Udco	
D388,016 S	12/1997	Kejejian	
5,694,791 A	12/1997	Esposito	
D406,247 S	3/1999	Chia et al.	D11/93
D418,445 S	1/2000	Chia et al.	D11/93
D418,446 S	1/2000	Chia et al.	D11/93
D423,981 S	5/2000	Chia et al.	D11/93

FOREIGN PATENT DOCUMENTS

CH	238894	8/1945	
EP	0 063 751 A1	11/1982 A44C/3/00
FR	608150	7/1926	
FR	709603	8/1931	
FR	1 319 354 A	5/1963	
GB	1 077 460	7/1967 A44C/17/02
GB	1 200 257	7/1970 A44C/9/00
GB	2 070 344 A	9/1981 H02G/3/04
GB	2 077 441 A	12/1981 G01R/33/06
WO	00/38551 A1	7/2000 A44C/17/02

OTHER PUBLICATIONS

Service Merchandise 1991/92 p. 68 items 19 and 20 heart rings and p. 79 heart earrings.*
A&A Jewelry Tools & Findings; Smooth edge coin, w/4 prong w/bail; 7 pages including G92.
All Karats International; Edizioni, Primavera–Estate/Spring–Summer, Sixth Edition; “Diamond Necklace”; 2 pages including cover (1998).
 California Gold Center; Bezel–set jewelry; 1 page. Not Dated.
 Caroline Ballou Collection; 18K Tribal Interpretations; and Barnett Robinson, Inc.; 18k yellow gold and platinum rings (1 page). Not Dated.
 “Charms” catalog by Americas GOLD; Item #136–20; p. 136. Not Dated.
 Corona; Corona’s Lasting Treasures Collection; Item SS 424. Not Dated.
 Crafford Precision Products Co.; “Laser Spot–Welding Systems”; 4 pages; (1997).
Fancy Catalog, Item Nos. 11111, 11112, 11114, p. 111 (total 14 pages), Not Dated.
 Gervais, J.; “A Little Light Welding”, *AJM*, 4 pages (May 1998).
 Hans D. Krieger; “JCK Show” catalog insert, Not Dated.
 Hans D. Krieger; “Platinum Classic”; A Promotional Supplement to *Jewelers’ Circular Keystone*, p. 178 (May 1997).
 Jaha Jewelry Inc.; 6 pages total including J6, J10, J13, Not Dated.
 Janet Alix necklace, *Jewelers’ Circular Keystone*, p. 132 (May 1997).
 “Liberty Collections” by Liberty I. Exchange; pp. 4 and 21 (Item 6ML–588 6.1gr), Not Dated.
 “Love Tears Collection” by Studs, Inc., *Jewelers’ Circular Keystone*; diamond solitaire necklaces in 18K gold; (Dec. 1997).
 Mervyn’s California catalog flyer; #14; Cache fashion watch; p. 11 (1998).
National Jeweler; Items #P10529, #84622, (May 16, 1997).
P.O.C. Jewelry; National Jeweler; Item N362, p. 142 (Jun. 1, 1998).
Robinson’s May, Earring, Item No. 290131409, Purchased Apr. 18, 1999, 3 pages.
 S&R Designs, Inc.; 18k Diamond Flower necklace, earrings, and bar bracelet; Styles Europa, 18k 2–one gold ring, bracelet, necklace with diamonds; 1 page.
 Superior Diamond Cutters Inc.; *Jewelers’ Circular Keystone*; Platinum and 18k gold slide pendant with diamonds; p. 108 (Dec. 1997).
The Multi–Color Gold Jewelry Book, Oro America, Earring Items: ETR.014 .95(39); ETR.022 1.0(42); ETLB.0011.7(71); p. 1, Not Dated.
 The Vatican Library Collection, *Jewelers’ Circumlar Keystone*; Skalet gold; Item 4D and 4I, 1 page.
 Uni–Creation Inc., Emby International Inc. Collection.; 1 page, Not Dated.
 Variety Gem Co., Inc.; *JCK Catalog 05–97*; Items N5526, N5520A, N5520B; one page (May 1997).
 Wards, Gold Hoop (Earring) with Diamond Cut Ovals, Item #459312000; Purchased Dec. 2000, 4 pages.

* cited by examiner

Primary Examiner—Louis S. Zarfes
Assistant Examiner—Deanne Levy
(74) *Attorney, Agent, or Firm*—Ladas & Parry

(57) **CLAIM**

The ornamental design for a jewelry component, as shown and described.

DESCRIPTION

Reference is made to Applicants': Application No. 09/224,936 filed December 31, 1998 entitled "DECORATIVE JEWELRY ARTICLE"; Application No. 09/383,814 filed August 26, 1999 entitled "DECORATIVE JEWELRY ITEM"; U.S. Design application No. 29/116,859 filed January 11, 2000, entitled "JEWELRY COMPONENT"; and U.S. Document Disclosure Certificate No. 459913, recorded July 30, 1999. FIG. 1 is a left side elevational view of the first, second, third, and fourth embodiments, the right elevational view being a mirror image; FIG. 2 is a front elevational view of the first, second, third, and fourth embodiments; FIG. 3 is a rear elevational view of the first, second, third, and fourth embodiments; FIG. 4 is a perspective view of a first embodiment of a jewelry component showing our new design; FIG. 5 is a top plan view of the first embodiment; FIG. 6 is a perspective view of a second embodiment of a jewelry component showing our new design; FIG. 7 is a top plan view of the second embodiment; FIG. 8 is a perspective view of a third embodiment of a jewelry component showing our new design;

FIG. 9 is a top plan view of the third embodiment; FIG. 10 is a perspective view of a fourth embodiment of a jewelry component showing our new design; FIG. 11 is a top plan view of the fourth embodiment; FIG. 12 is a left side elevational view of the fifth, sixth, seventh, and eighth embodiments, the right elevational view being a mirror image; FIG. 13 is a front elevational view of the fifth, sixth, seventh, and eighth embodiments; FIG. 14 is a rear elevational view of the fifth, sixth, seventh, and eighth embodiments; FIG. 15 is a perspective view of a fifth embodiment of a jewelry component showing our new design; FIG. 16 is a top plan view of the fifth embodiment; FIG. 17 is an enlarged partial cross sectional view taken along the line 17—17 in FIGS. 16, 19, 21, and 23; FIG. 18 is a perspective view of a sixth embodiment of a jewelry component showing our new design; FIG. 19 is a top plan view of the sixth embodiment; FIG. 20 is a perspective view of a seventh embodiment of a jewelry component showing our new design; FIG. 21 is a top plan view of the seventh embodiment; FIG. 22 is a perspective view of an eighth embodiment of a jewelry component showing our new design; and, FIG. 23 is a top plan view of the eighth embodiment. The broken line showing of the base of the jewelry component is for illustrative purposes only and forms no part of the claimed design.

1 Claim, 3 Drawing Sheets

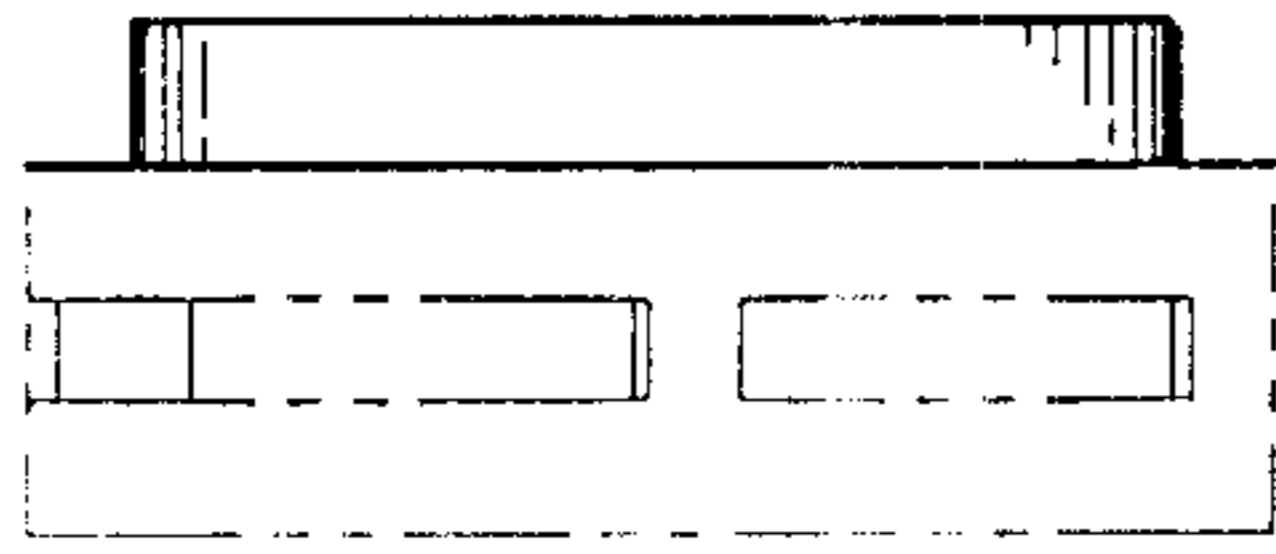

FIG. 1

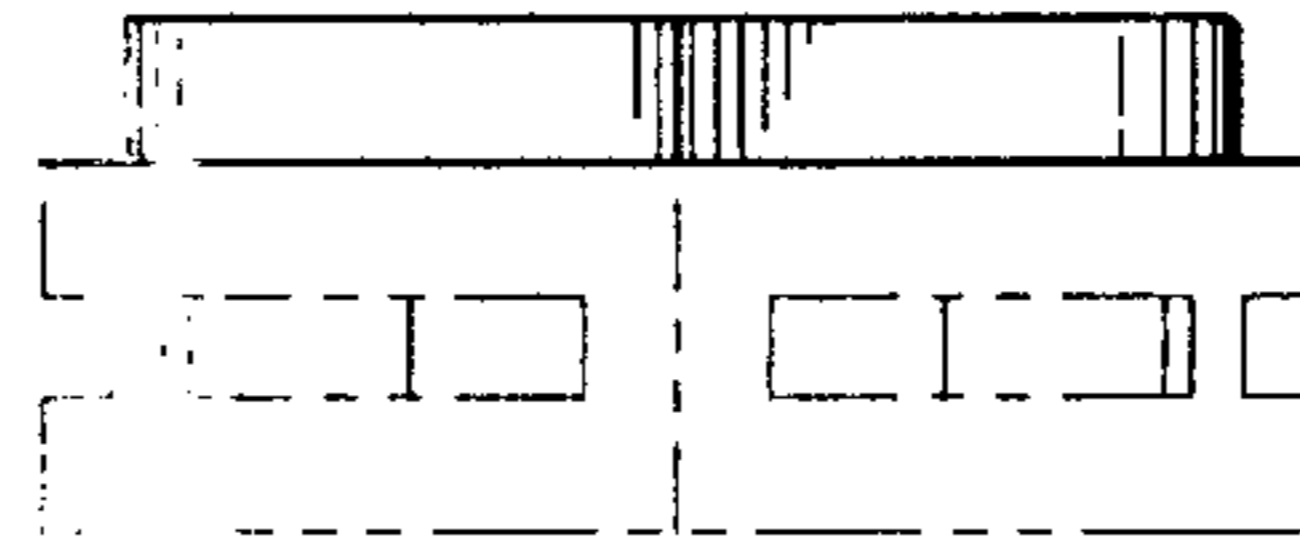

FIG. 2

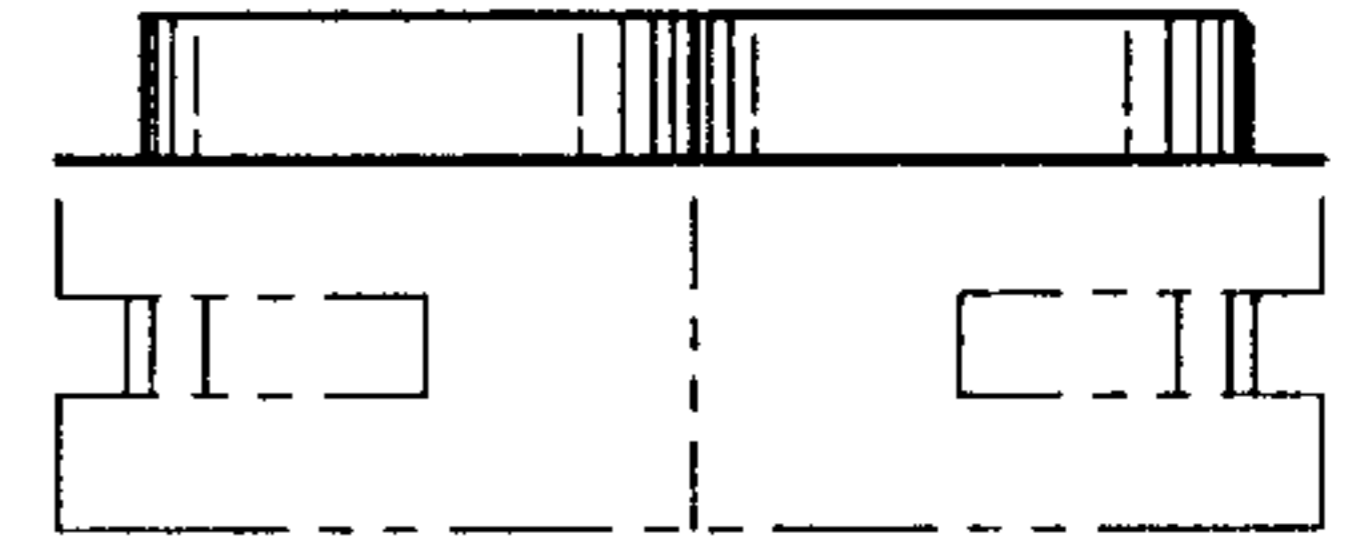

FIG. 3

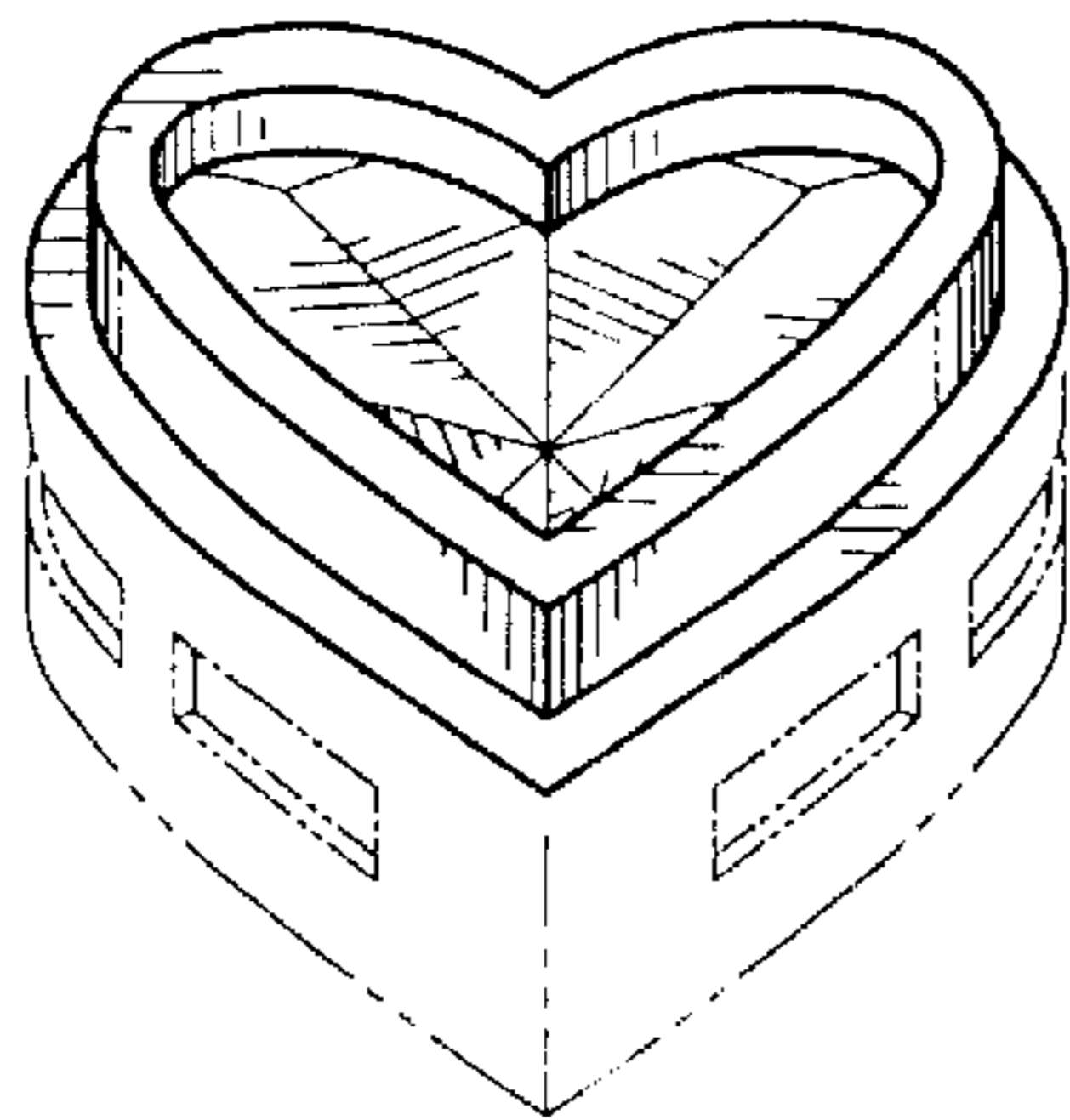

FIG. 4

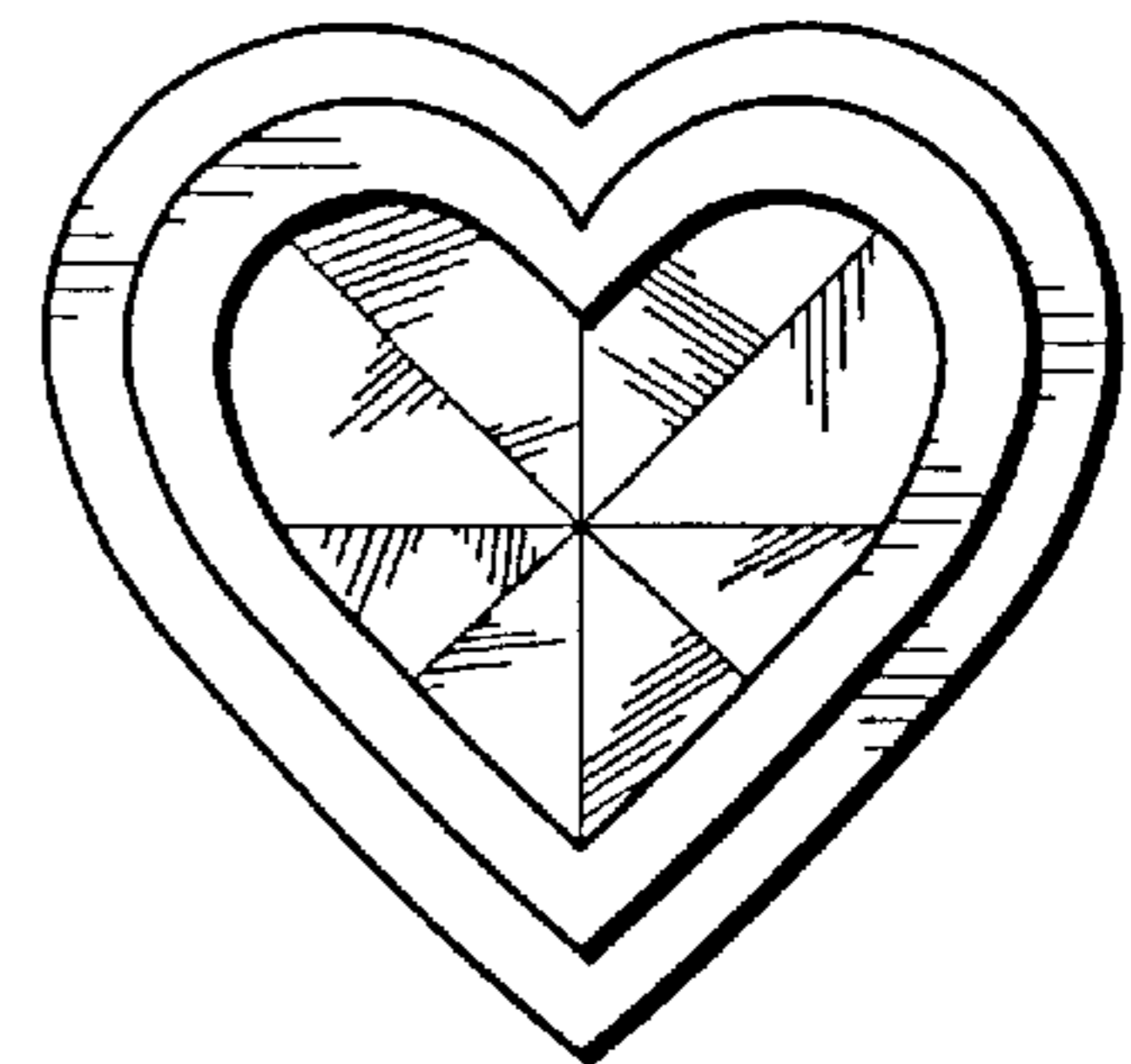

FIG. 5

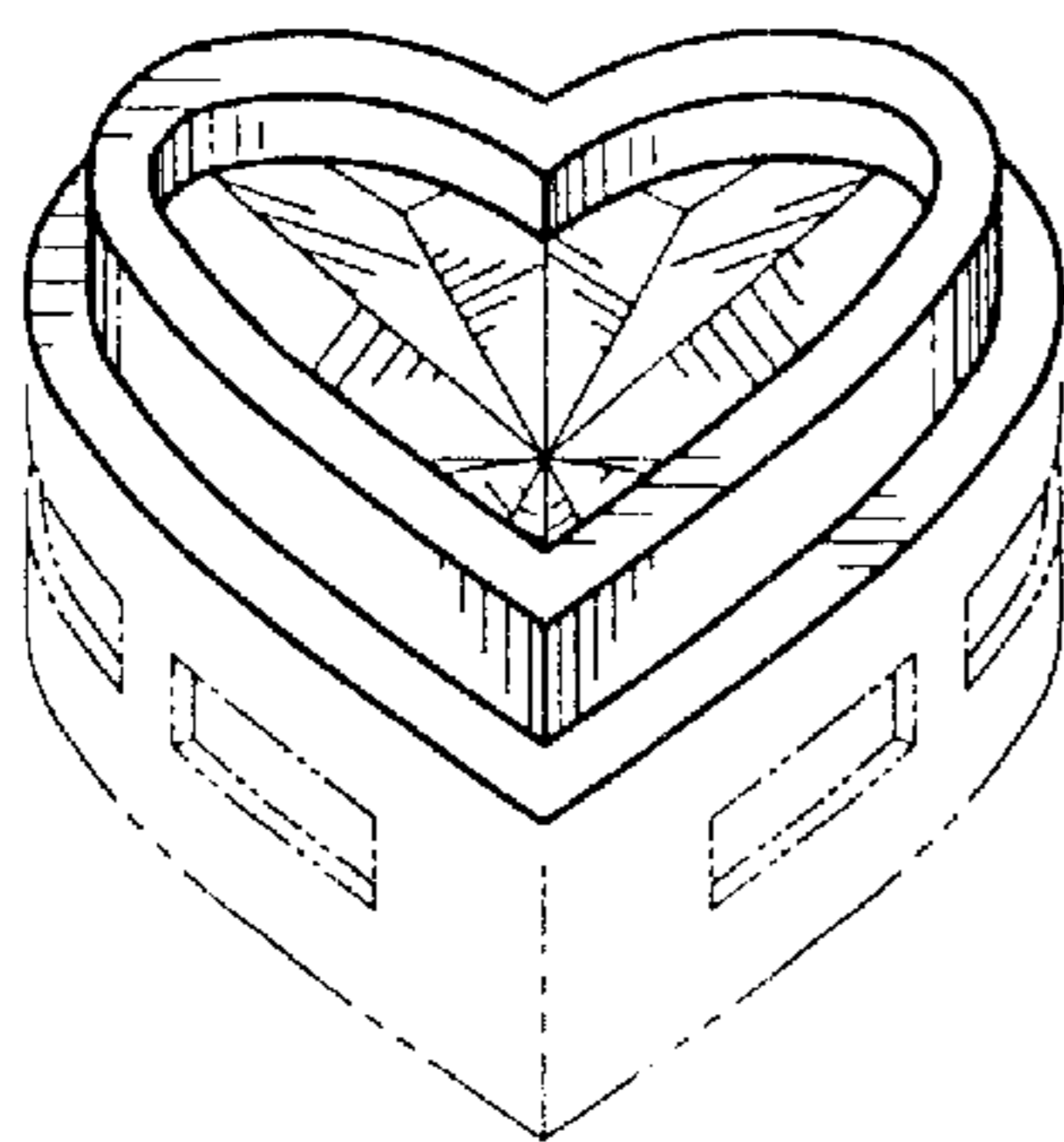

FIG. 6

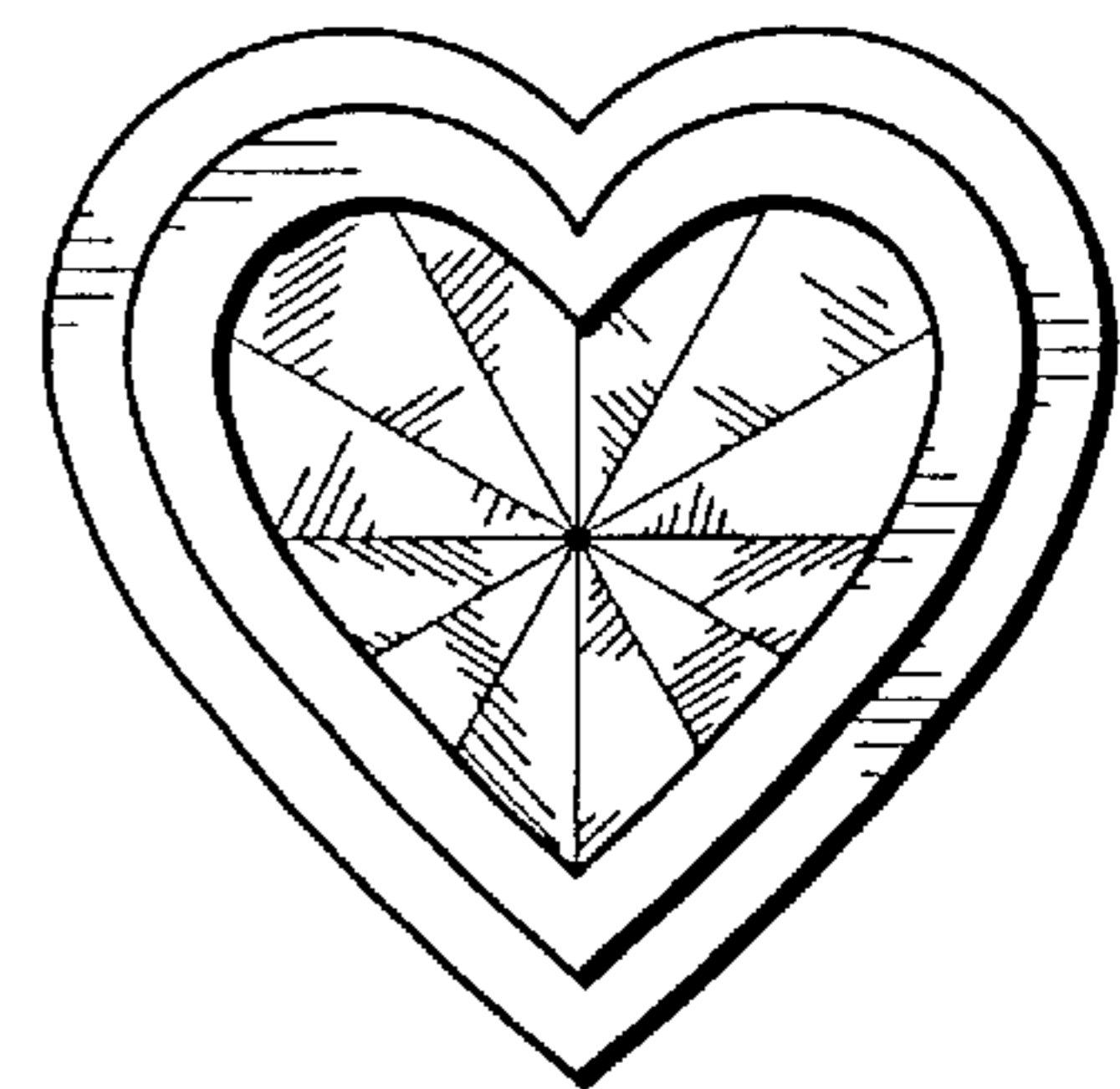

FIG. 7

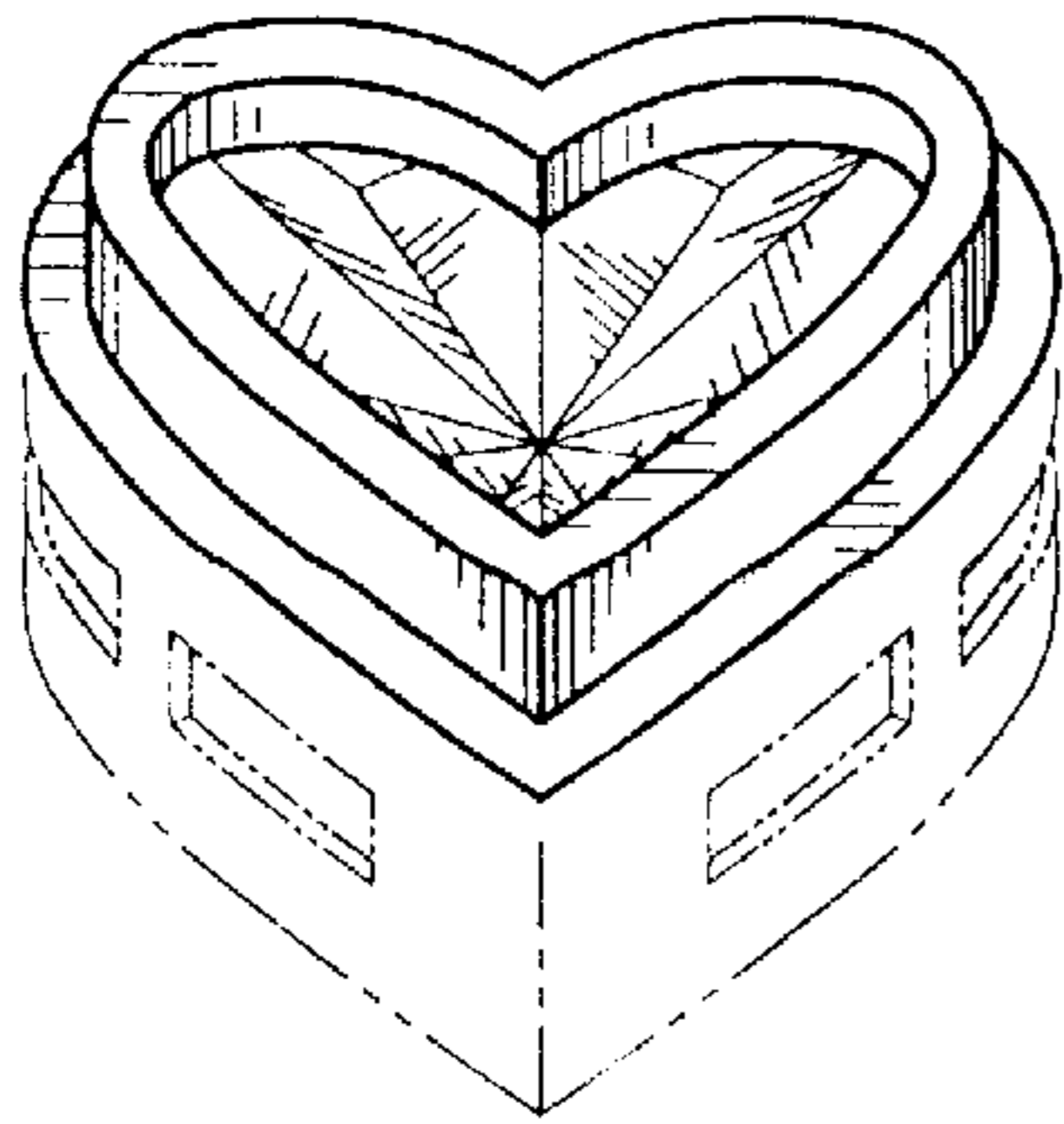

FIG. 8

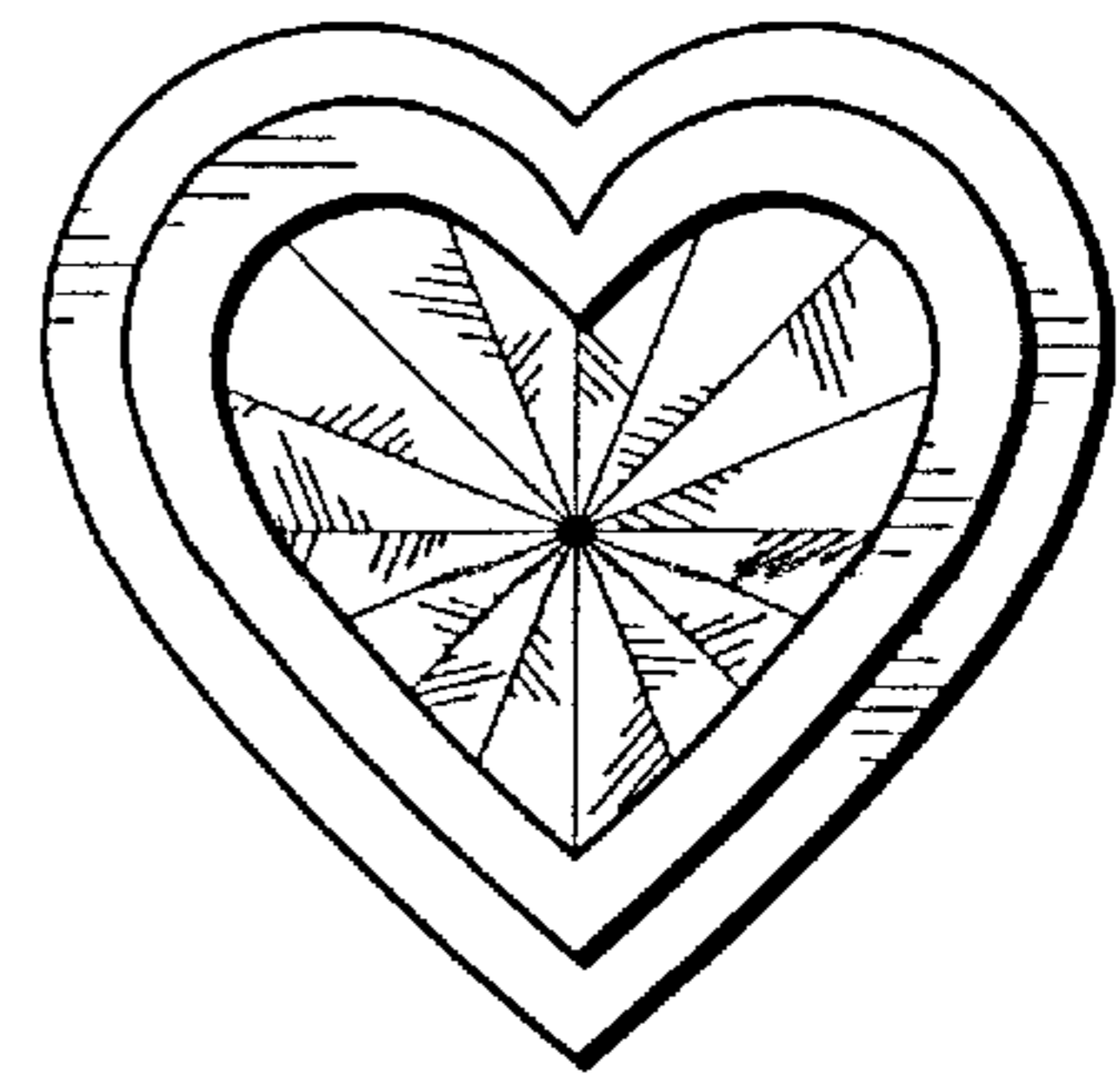

FIG. 9

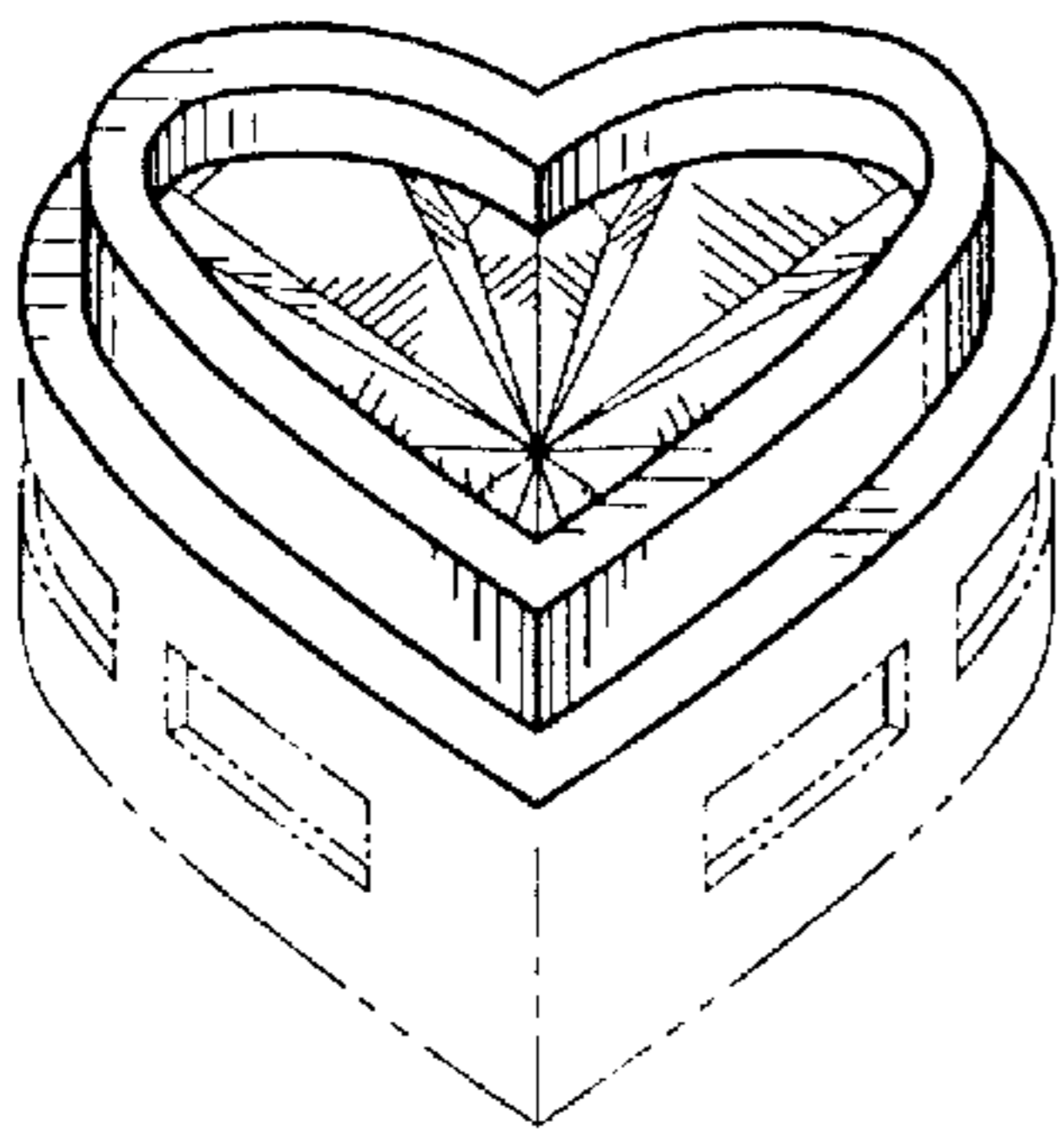

FIG. 10

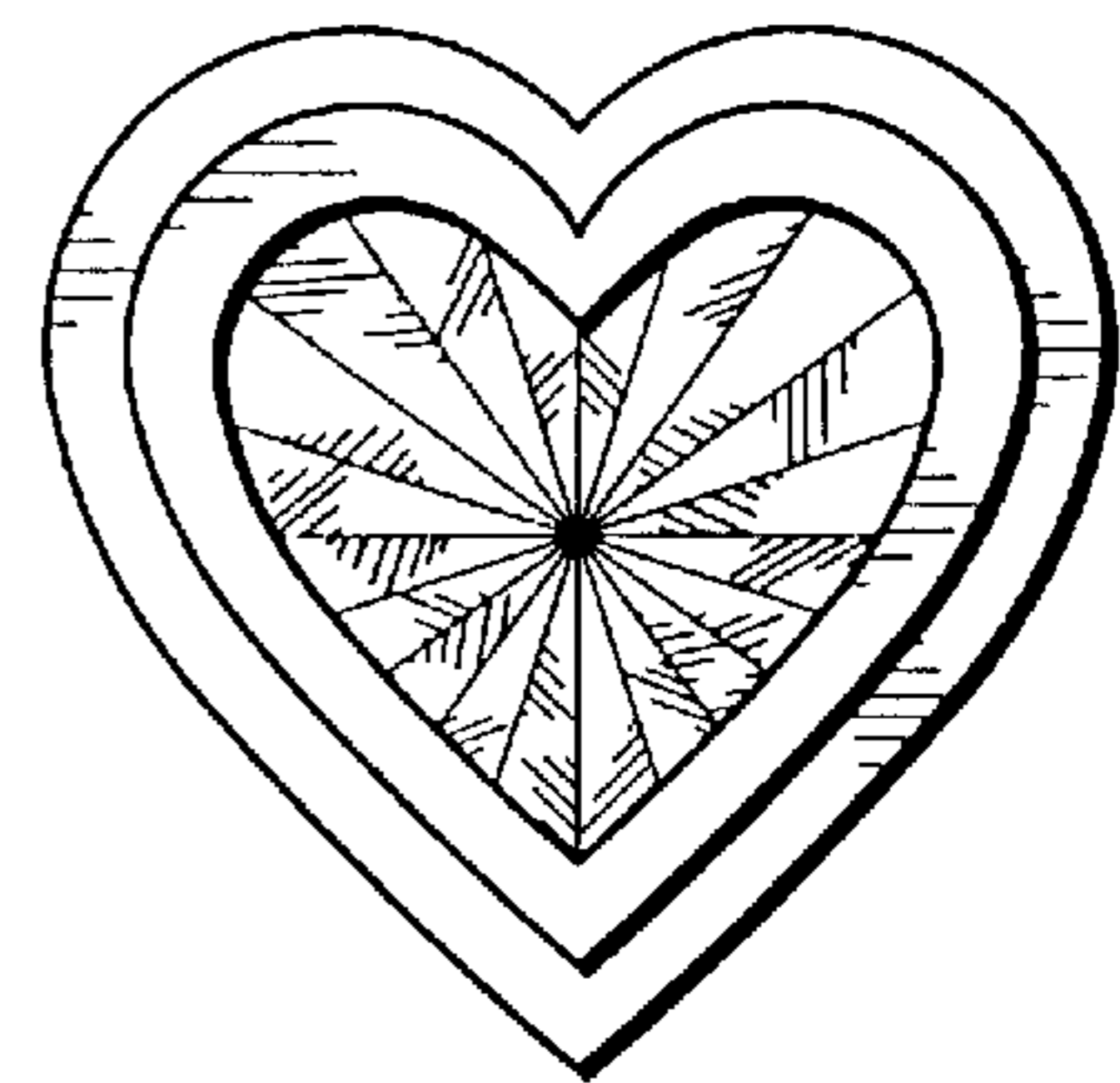

FIG. 11

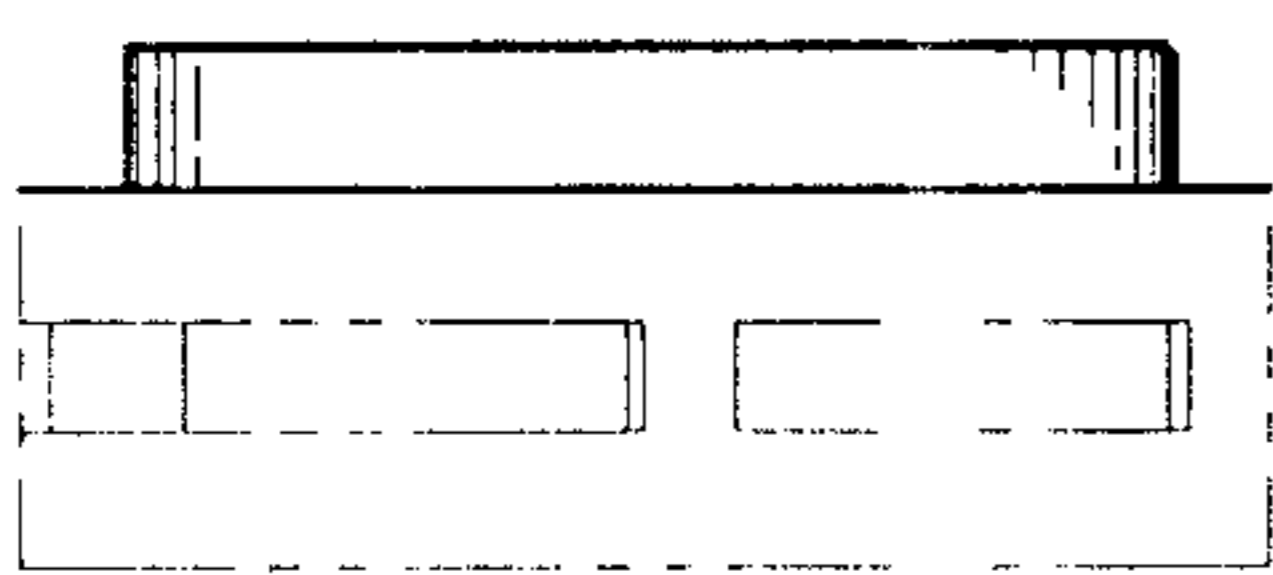

FIG. 12

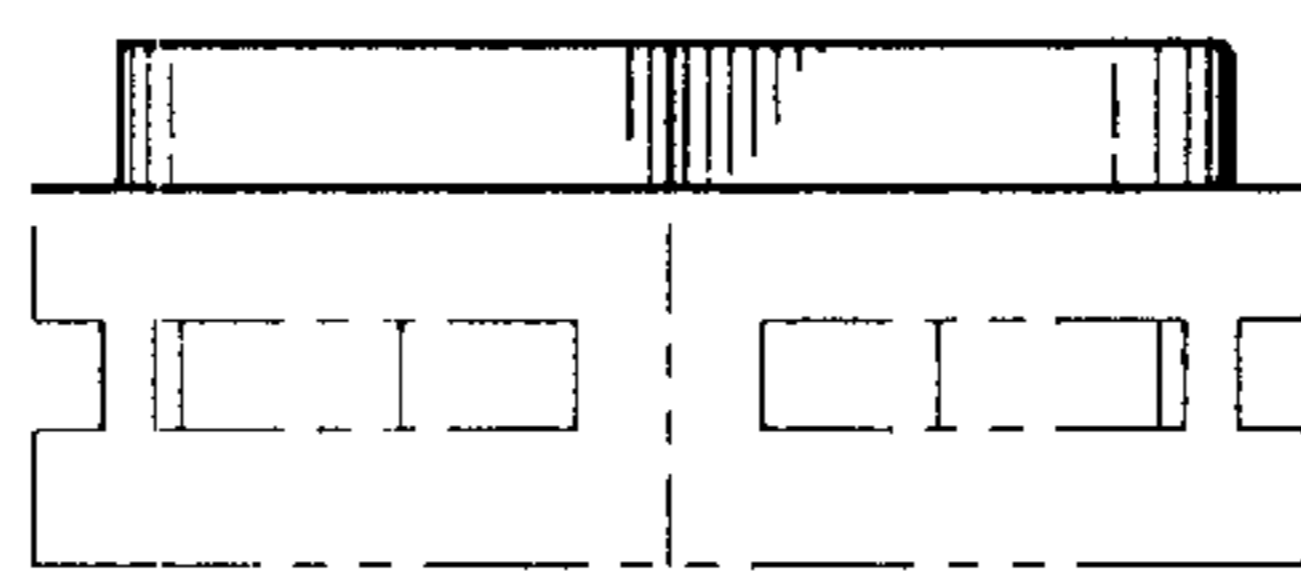

FIG. 13

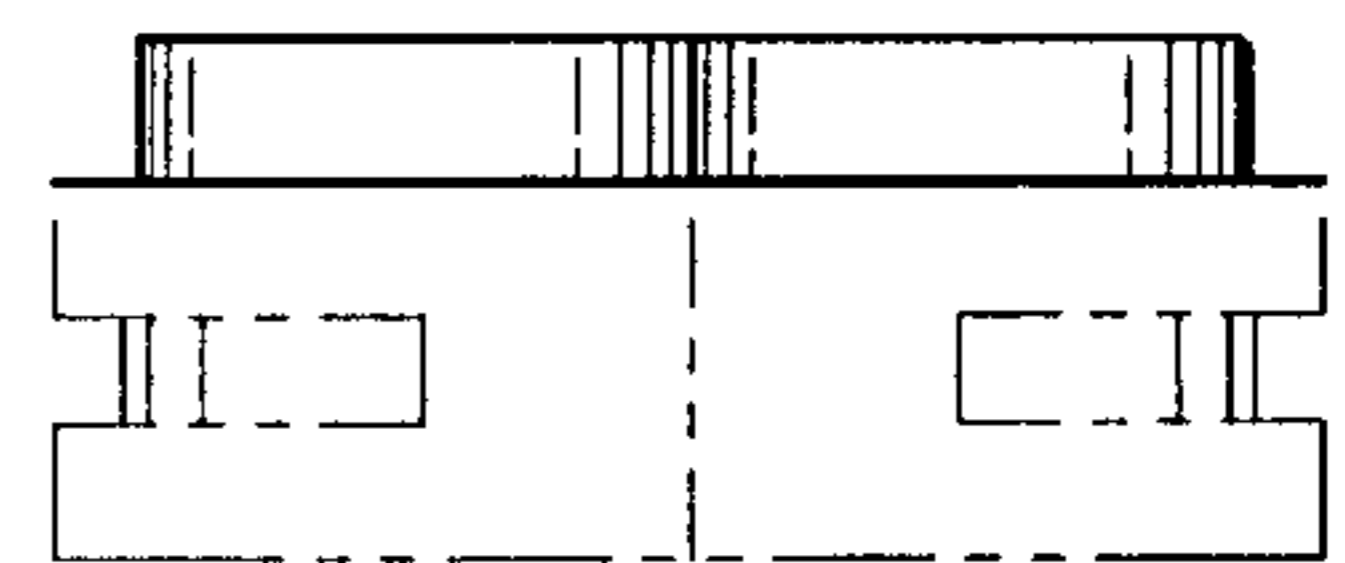

FIG. 14

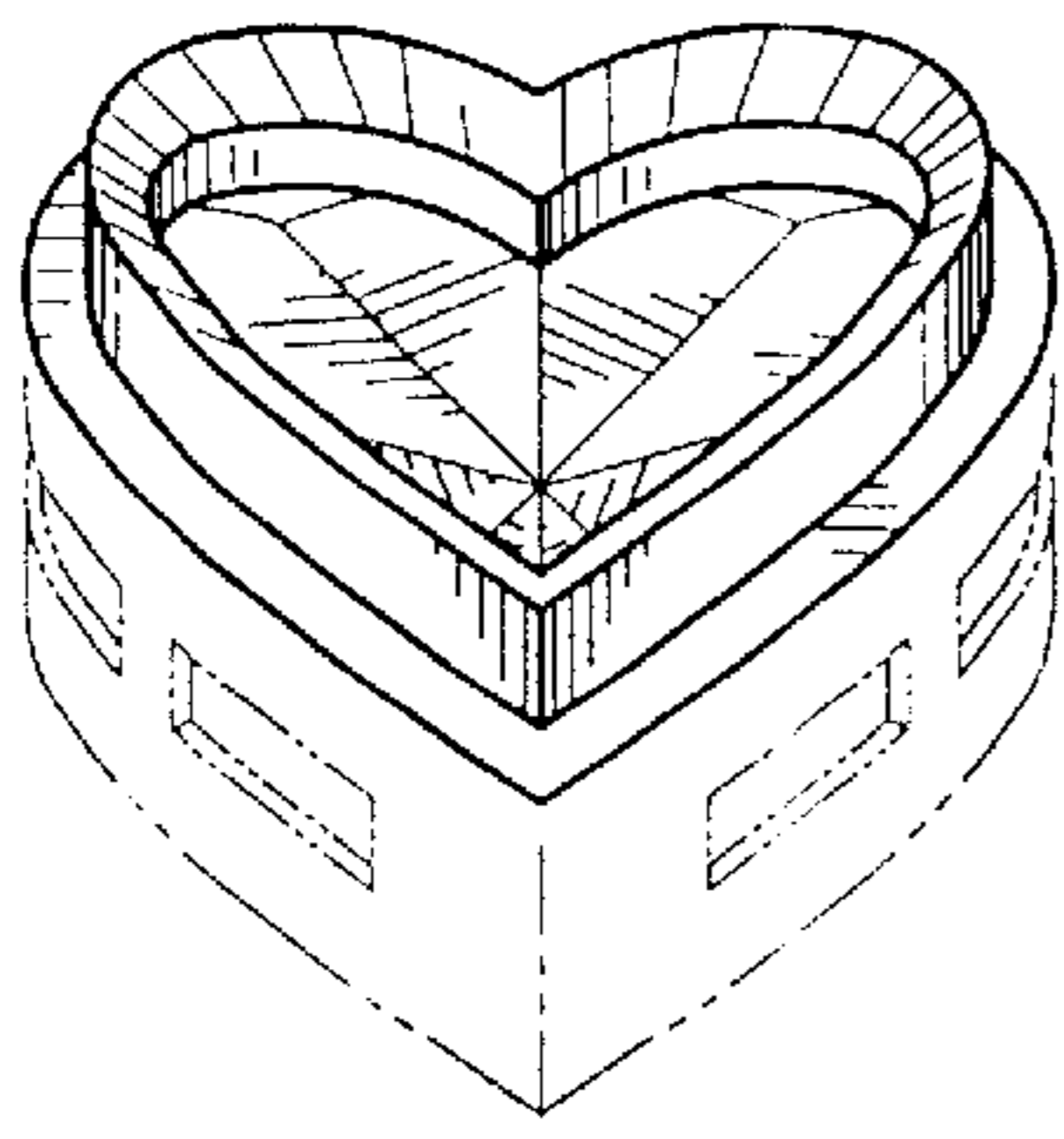

FIG. 15

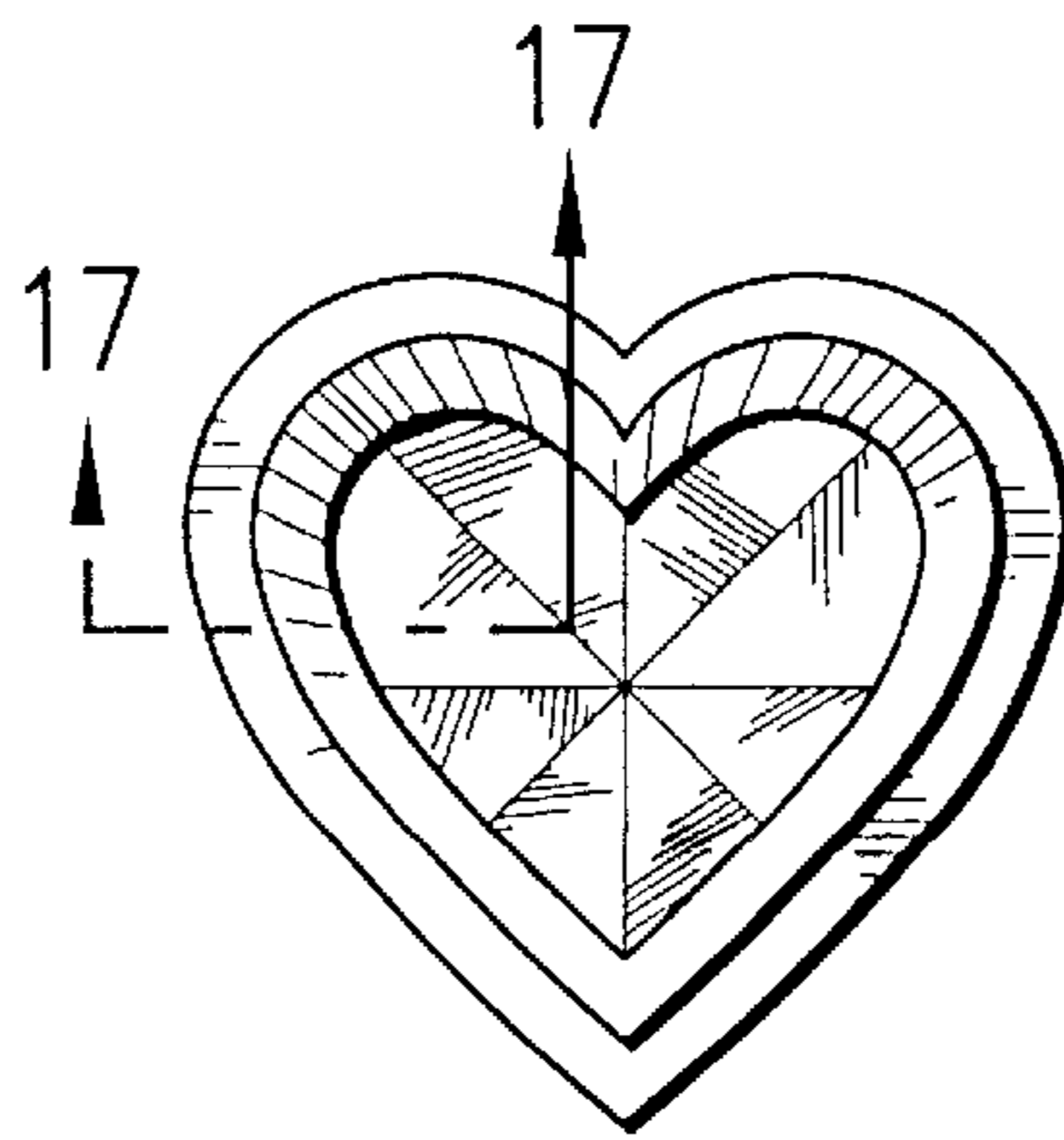

FIG. 16

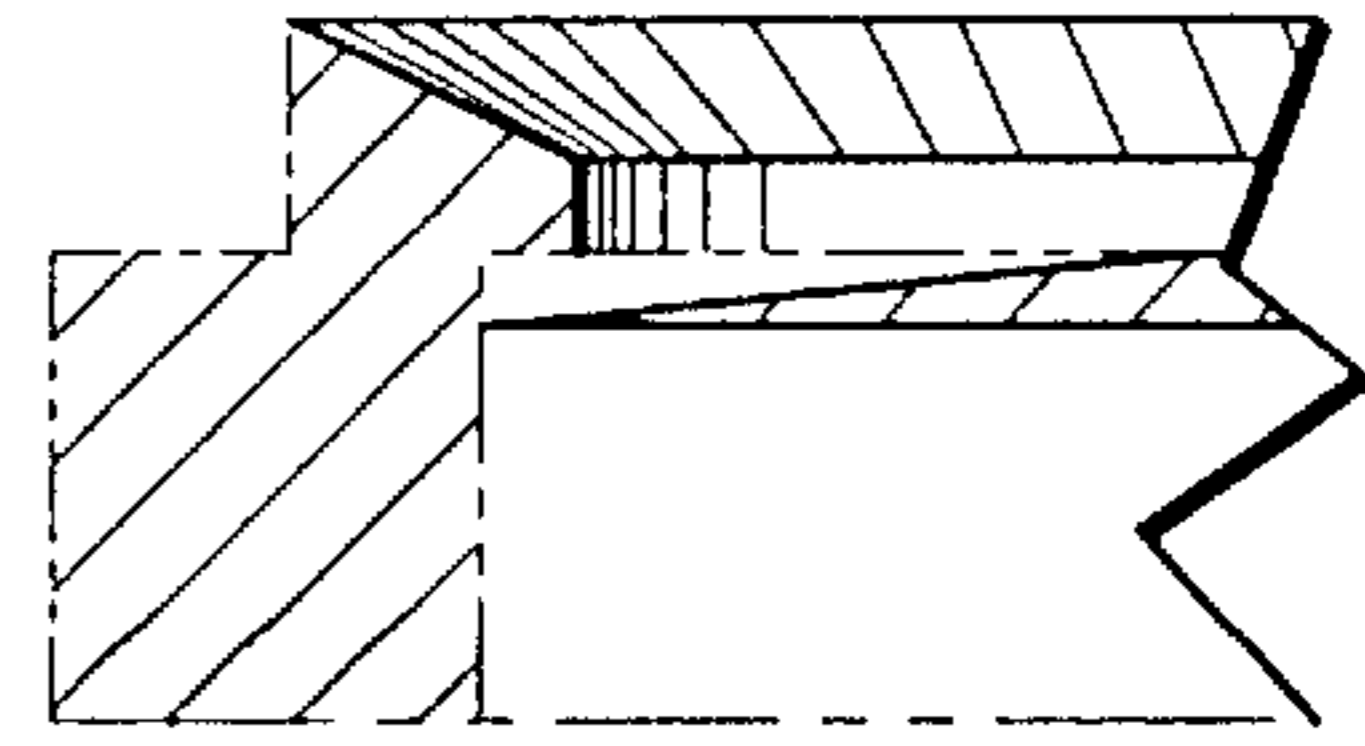

FIG. 17

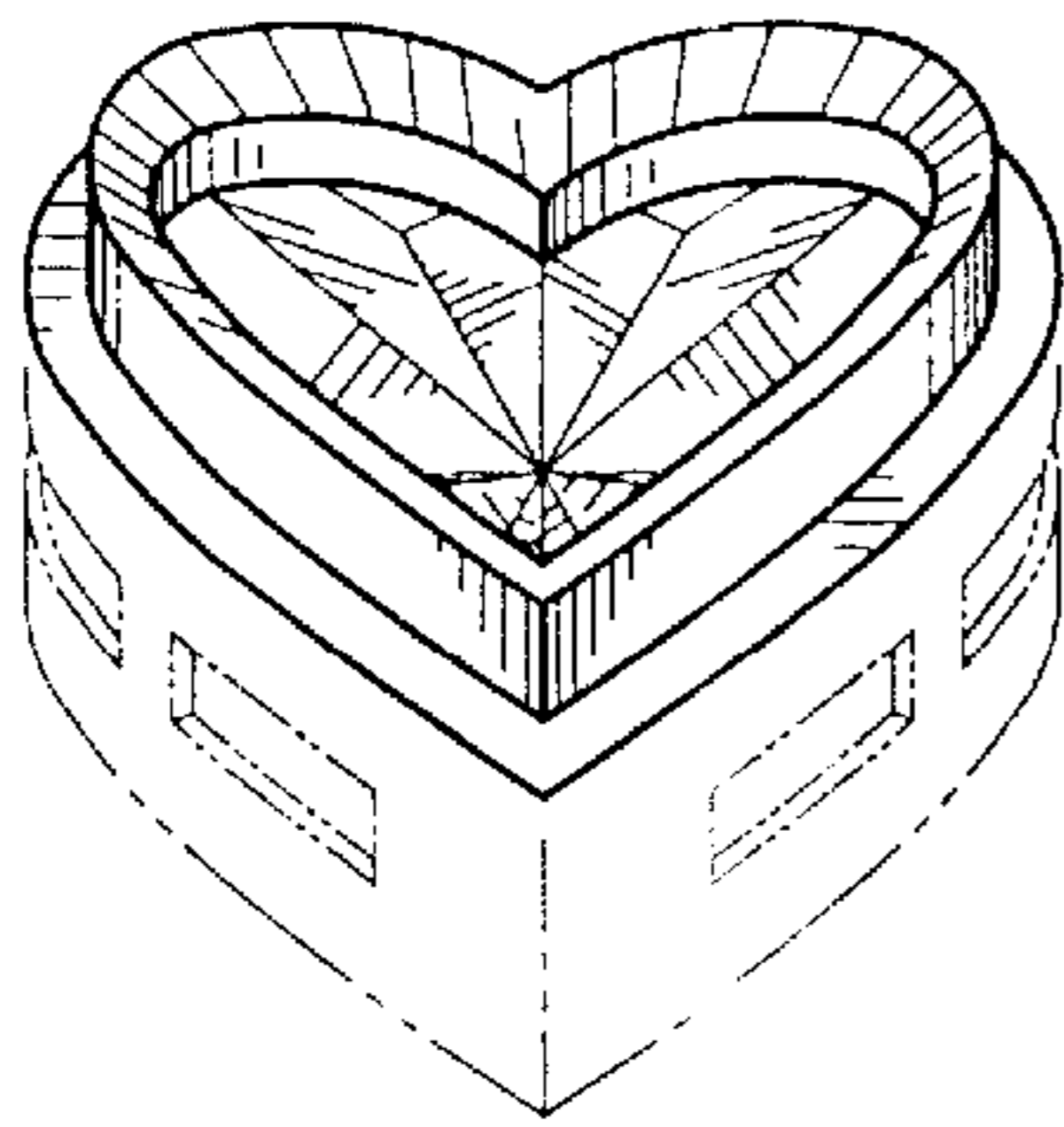

FIG. 18

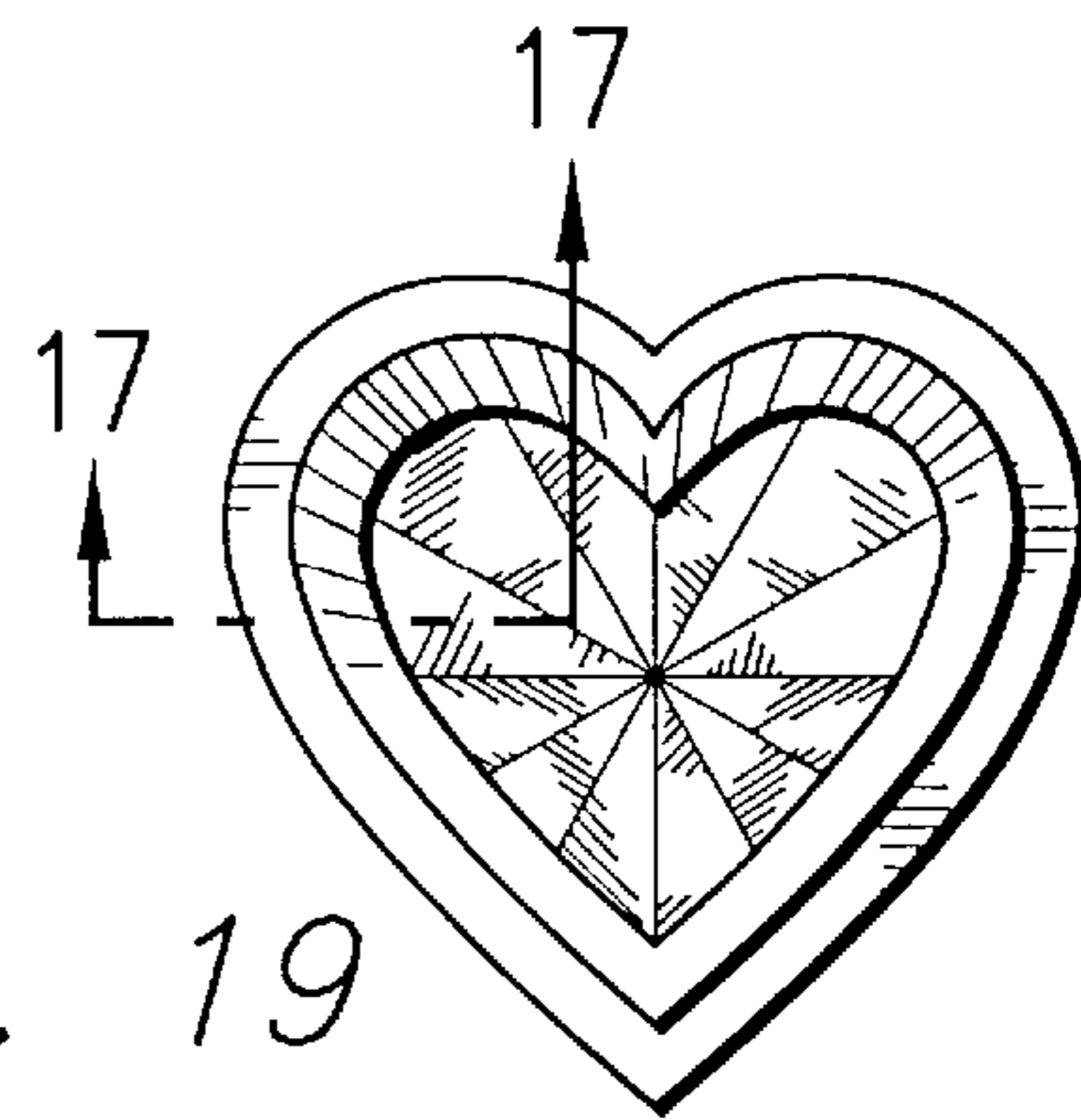

FIG. 19

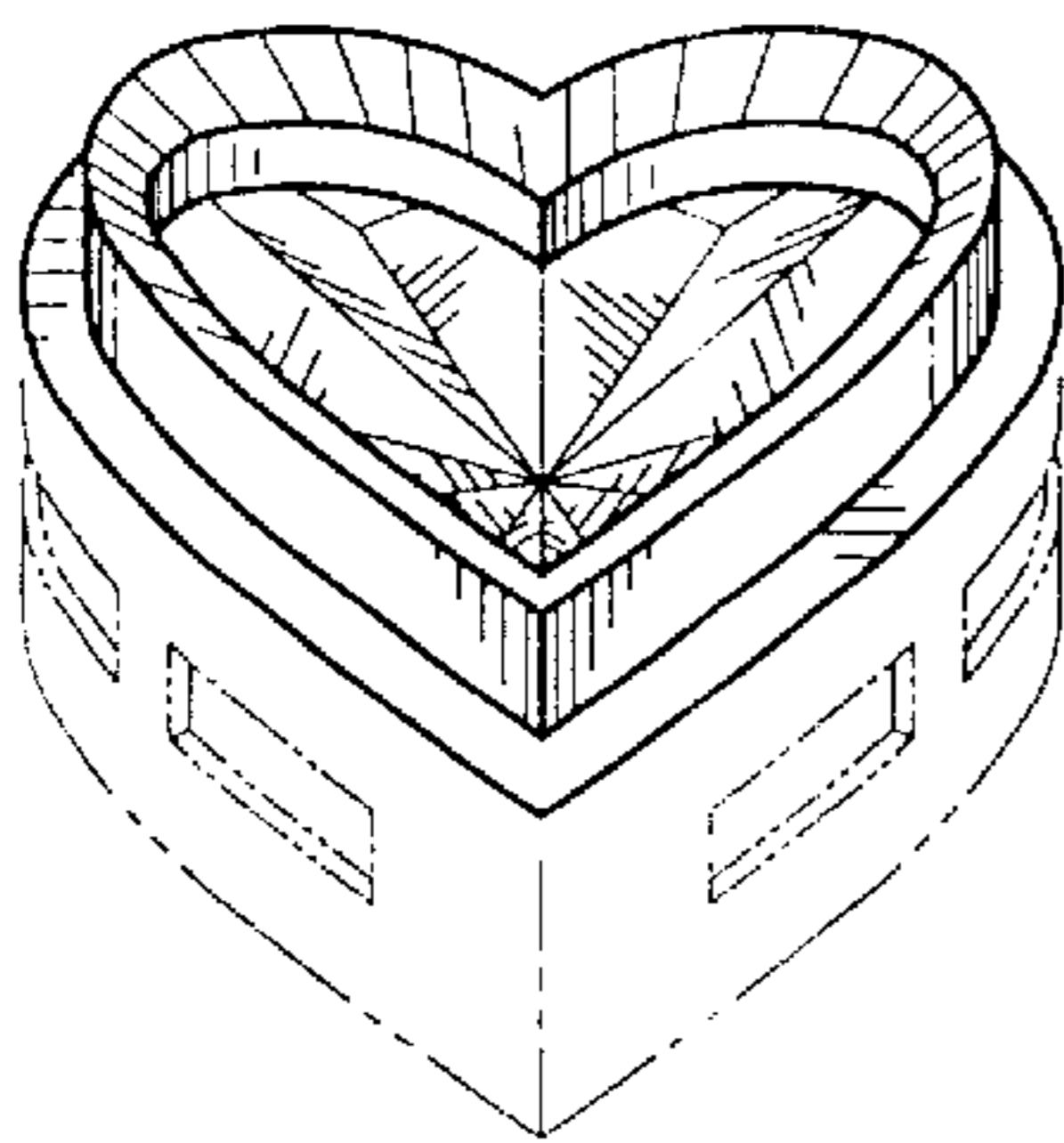

FIG. 20

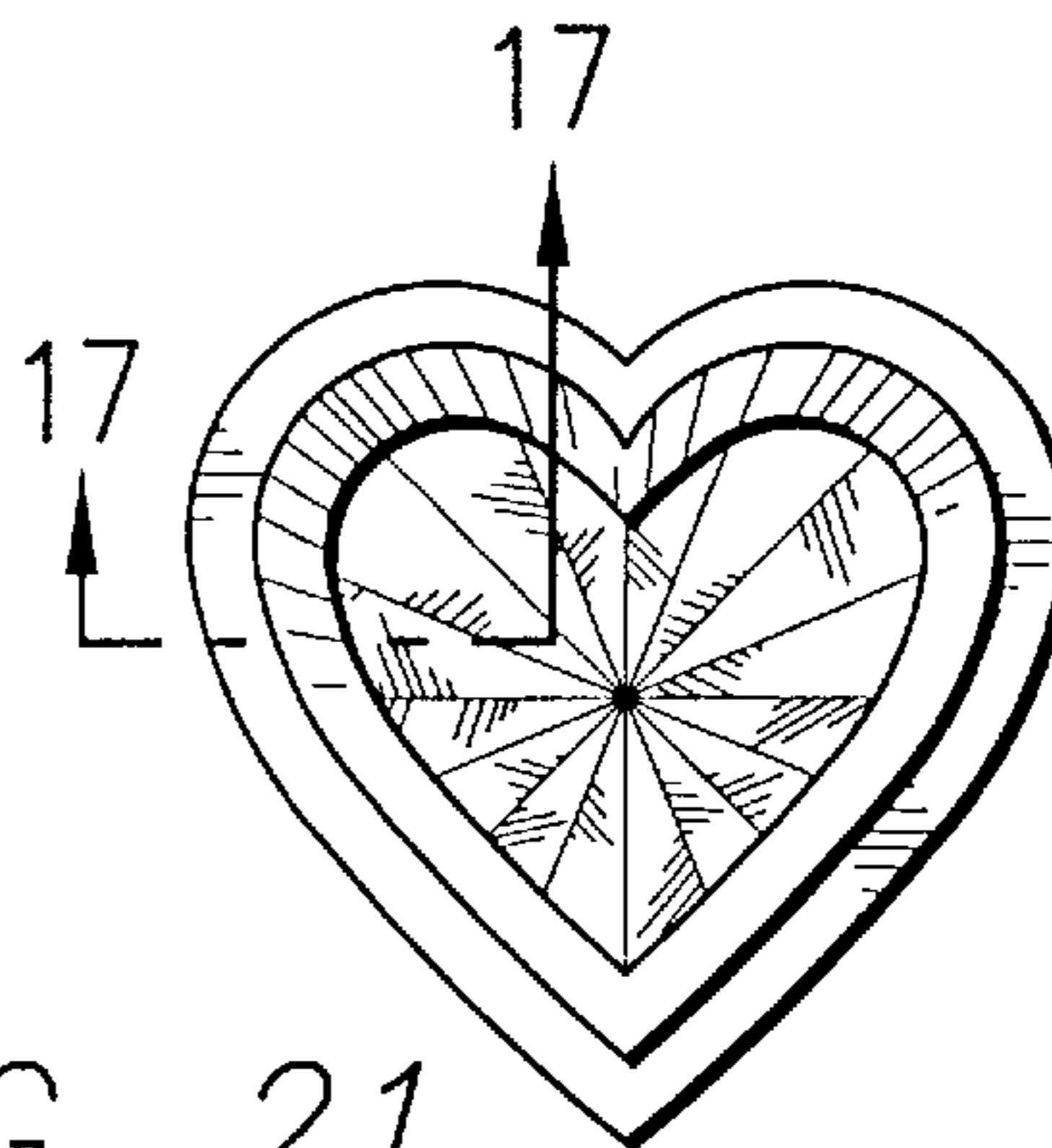

FIG. 21

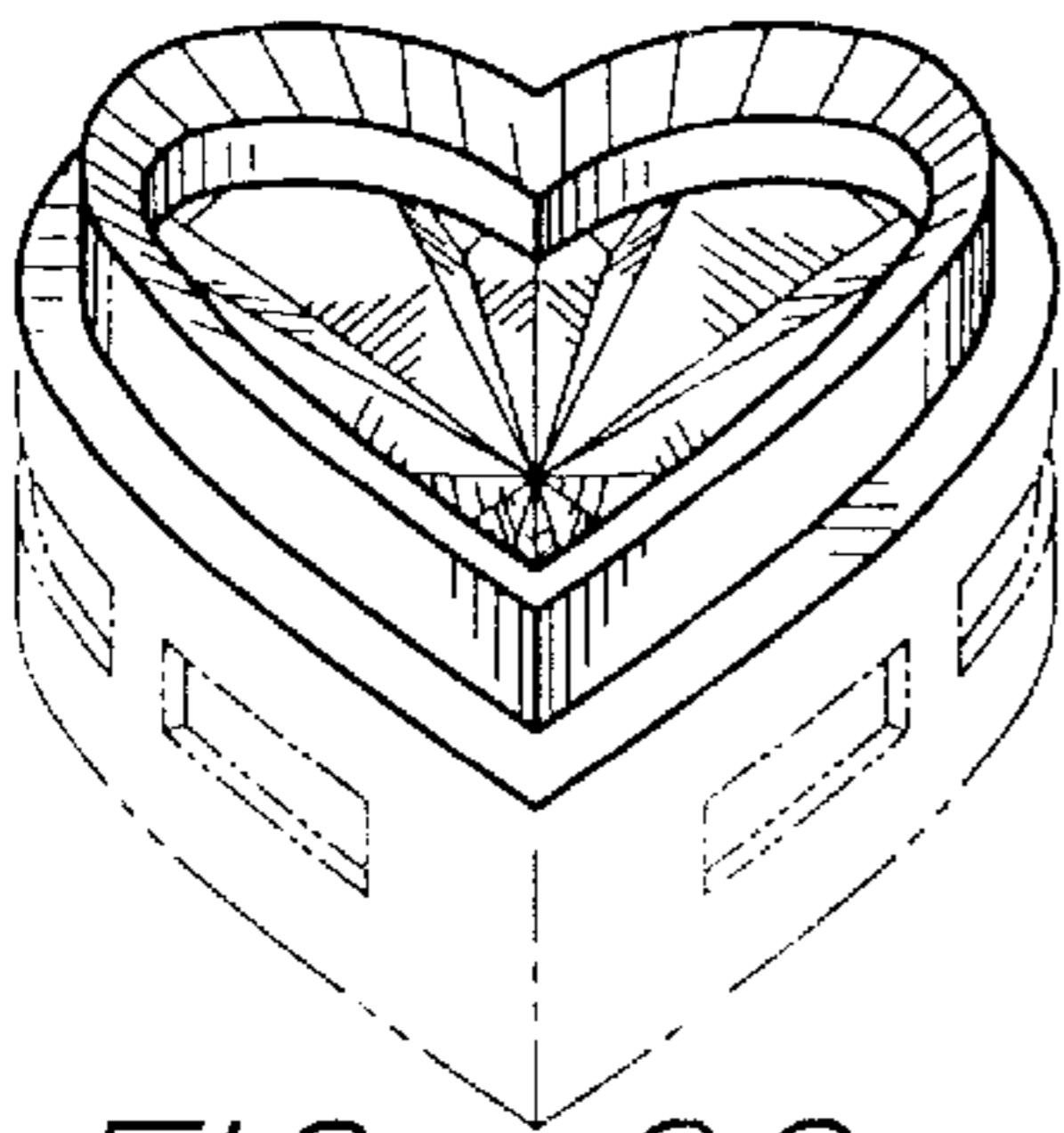

FIG. 22

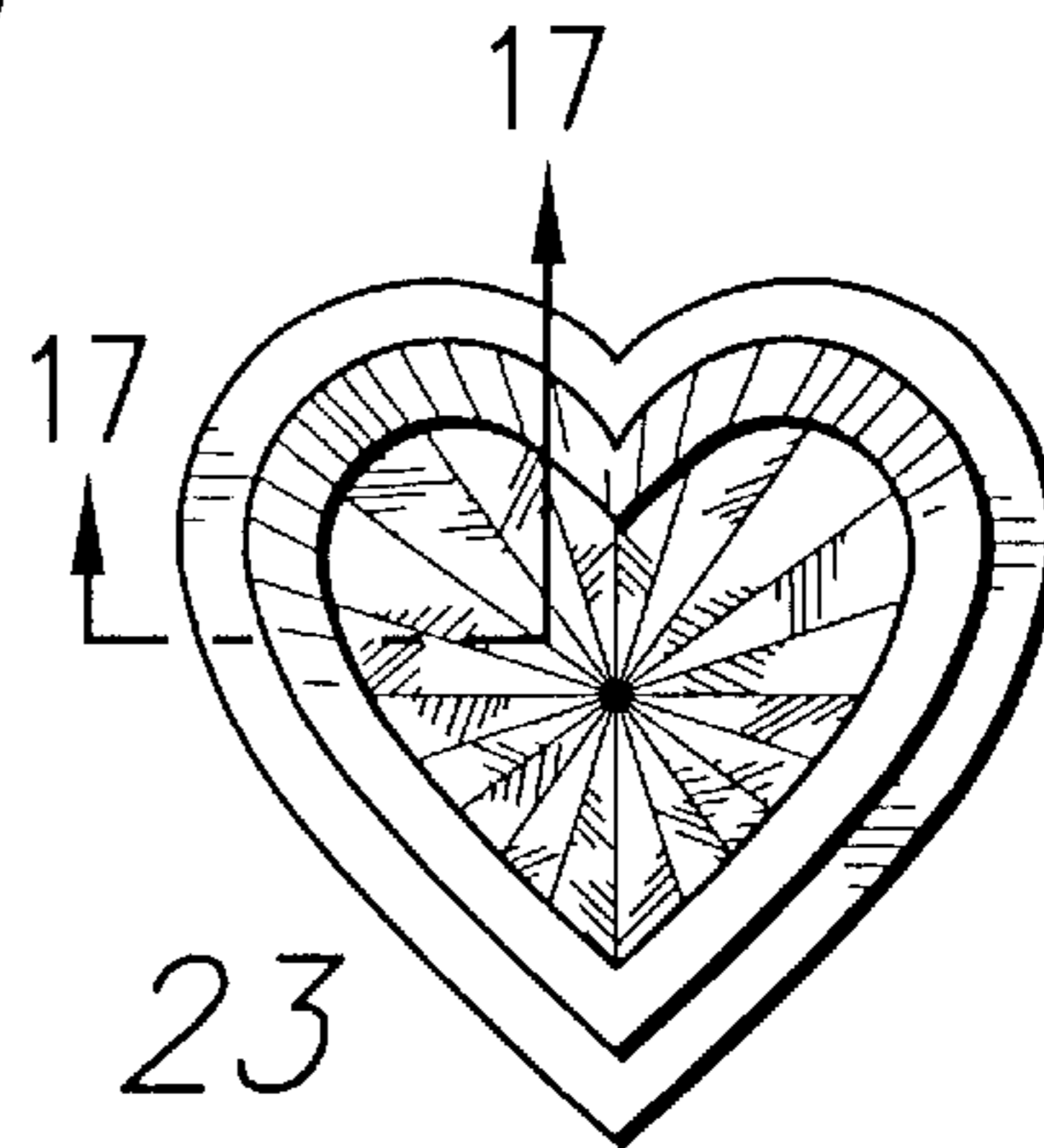

FIG. 23