



US00D471718S

(12) **United States Design Patent**
Park

(10) **Patent No.:** **US D471,718 S**

(45) **Date of Patent:** **** Mar. 18, 2003**

(54) **HAIR BRUSH**

(76) Inventor: **Ran Kyu Park**, 5-103, Hyochang-dong
yongsan-ku, Seoul (KR)

(**) Term: **14 Years**

(21) Appl. No.: **29/165,307**

(22) Filed: **Aug. 8, 2002**

(51) **LOC (7) Cl.** **04-02**

(52) **U.S. Cl.** **D4/133; D4/136**

(58) **Field of Search** D4/128, 133, 136,
D4/138; 15/27, 143.1, 159.1, 160, 186-188,
DIG. 6, 207.2; 16/110.1, 430, 431; 132/120,
271, 313

(56) **References Cited**

U.S. PATENT DOCUMENTS

4,197,608 A * 4/1980 Holley et al. 15/27
D434,910 S * 12/2000 Kim D4/136
D438,388 S * 3/2001 Cheung D4/136
D456,145 S * 4/2002 Wong D4/128

FOREIGN PATENT DOCUMENTS

EP 1078585 * 2/2001 A46B/9/00
FR 2482842 * 11/1981 A45D/6/04
JP 2002-112835 * 4/2002 A46B/5/00
KR 142558 9/1993
KR 108642 12/1993
KR 158571 1/1995
KR 162235 4/1995
KR 0217225 3/1998
KR 156333 4/1998
KR 211867 4/1998
KR 211961 4/1998
KR 214959 4/1998
KR 0224612 7/1998
KR 0225488 8/1998
KR 0231209 11/1998
KR 0231210 11/1998
KR 0231211 11/1998
KR 0231212 11/1998
KR 30-0236650 1/1999

KR 30-0287757 11/2001
KR 30-0282626 1/2002
WO WO 89/04619 * 6/1989 A46B/5/04
WO WO 90/03130 * 4/1990 A46B/9/00

OTHER PUBLICATIONS

U.S. Ser. patent application No. 29/163 039, Applicant: Ran Kyu Park, filed Jun. 26, 2002, including specification, claim and 7 sheets of drawings.

U.S. Ser. patent application No. 29/165 308, Applicant: Ran Kyu Park, filed Aug. 8, 2002, including specification, claim and 5 sheets of drawings.

U.S. Ser. patent application No. 29/165 749, Applicant: Ran Kyu Park, filed Aug. 15, 2002, including specification, claim and 7 sheets of drawings.

U.S. Ser. patent application No. 29/165 751, Applicant: Ran Kyu Park, filed Aug. 15, 2002, including specification, claim and 6 sheets of drawings.

* cited by examiner

Primary Examiner—Alan P. Douglas

Assistant Examiner—Lavone D. Tabor

(74) *Attorney, Agent, or Firm*—Flynn, Thiel, Boutell & Tanis, P.C.

(57) **CLAIM**

The ornamental design of a hair brush, as shown and described.

DESCRIPTION

FIG. 1. is a top front perspective view of a hair brush showing my new design.

FIG. 2. is a front elevational view thereof.

FIG. 3. is a rear elevational view thereof.

FIG. 4. is a left side elevational, a right side view is symmetrical to the left side elevational view.

FIG. 5. is top plan view thereof.

FIG. 6. is a bottom plan view thereof.

FIG. 7 is a sectional view taken along line 7—7 of FIG. 2; and,

FIG. 8 is a sectional view taken along line 8—8 of FIG. 2.

1 Claim, 6 Drawing Sheets

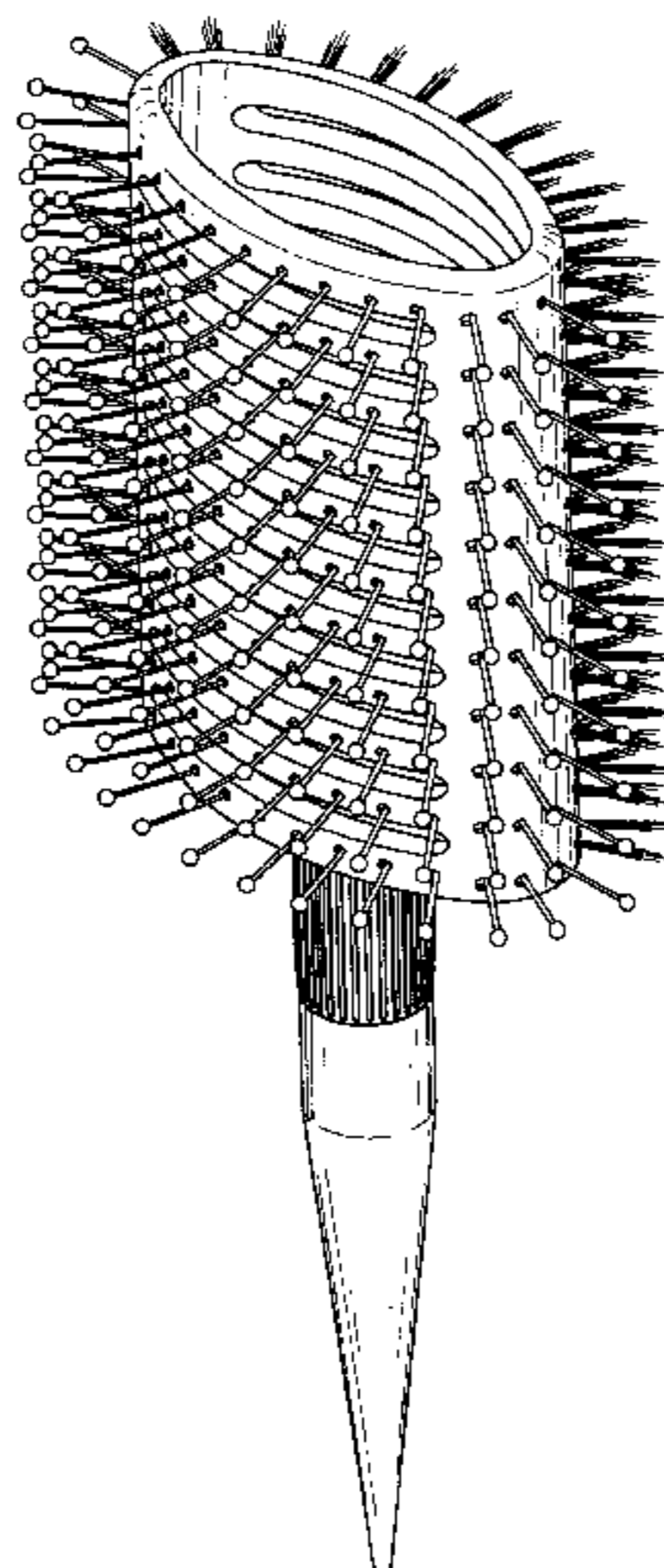

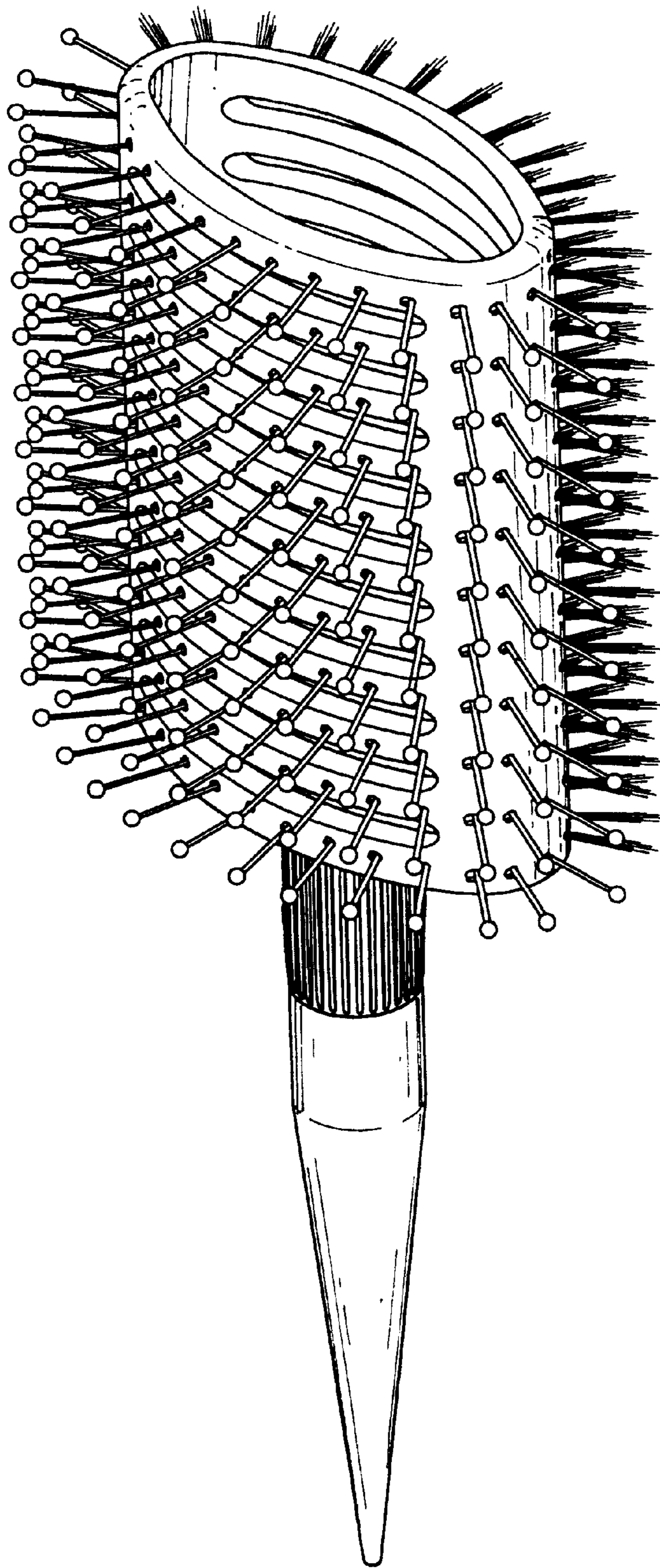

FIG. 1

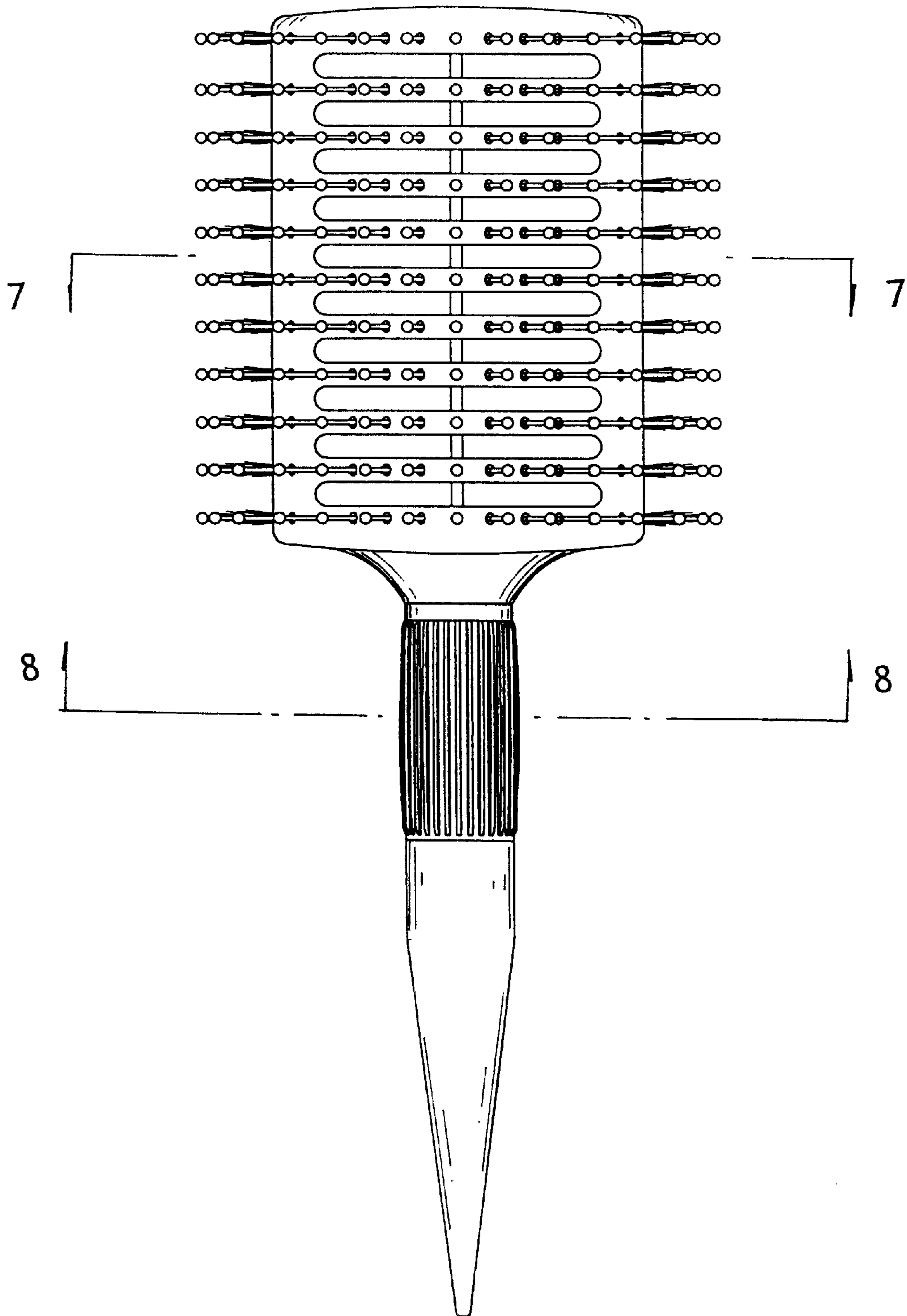

FIG. 2

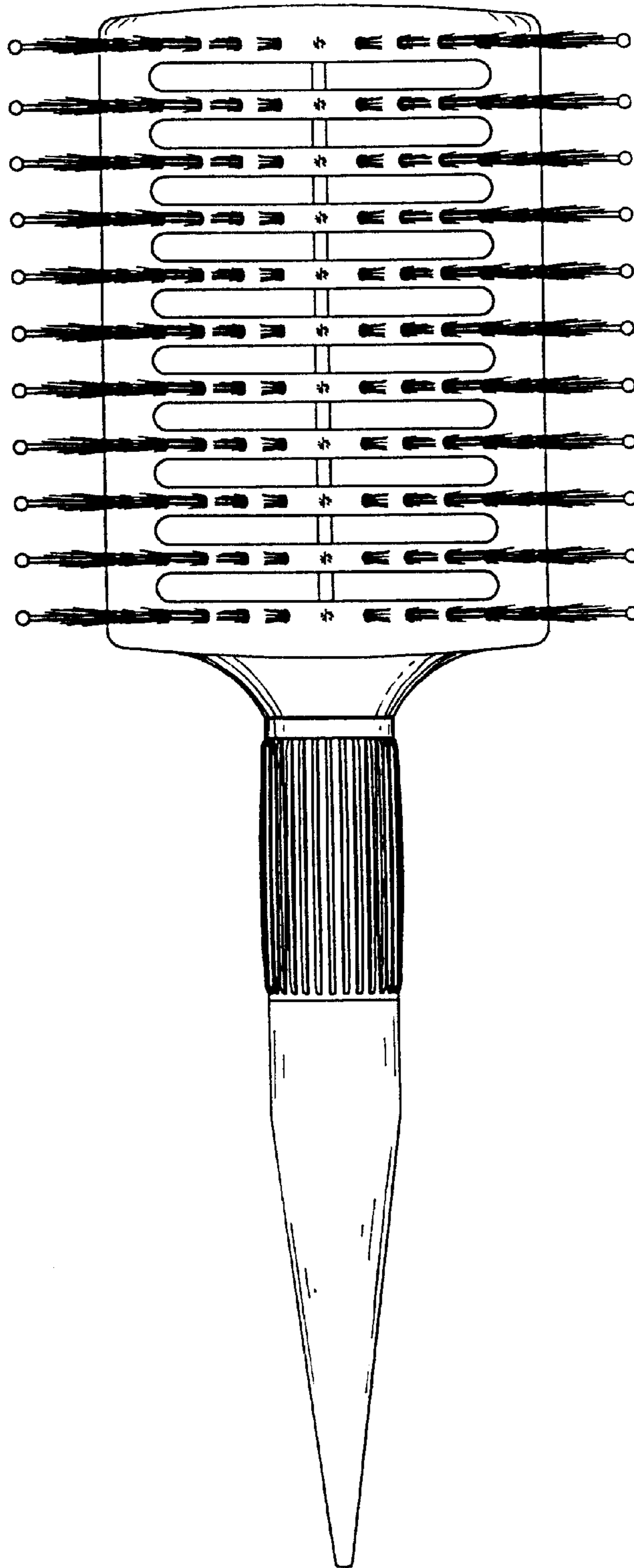

FIG. 3

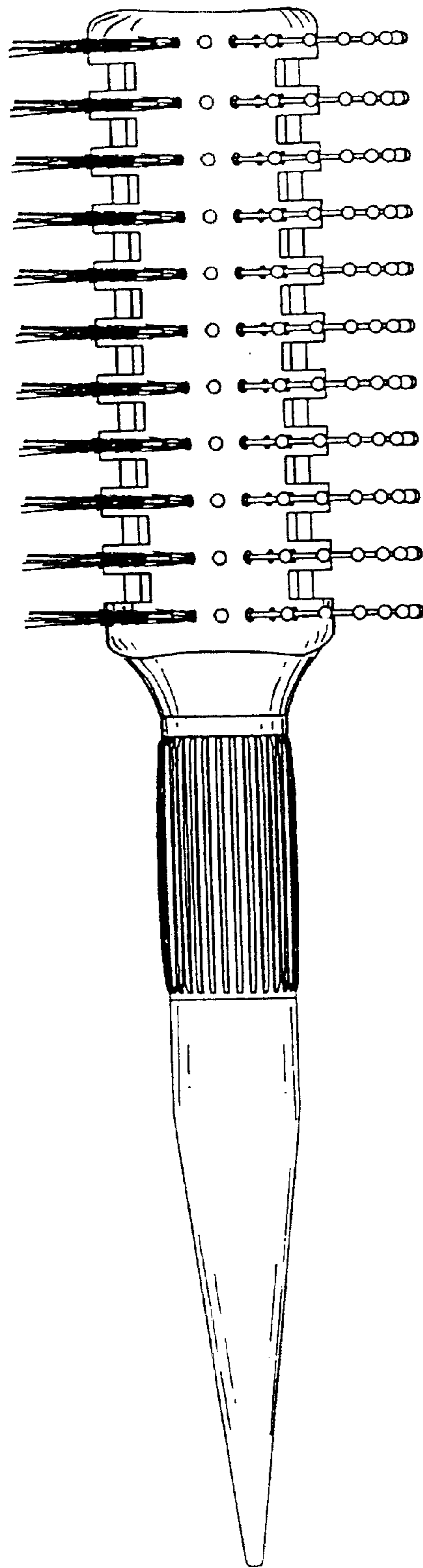

FIG. 4

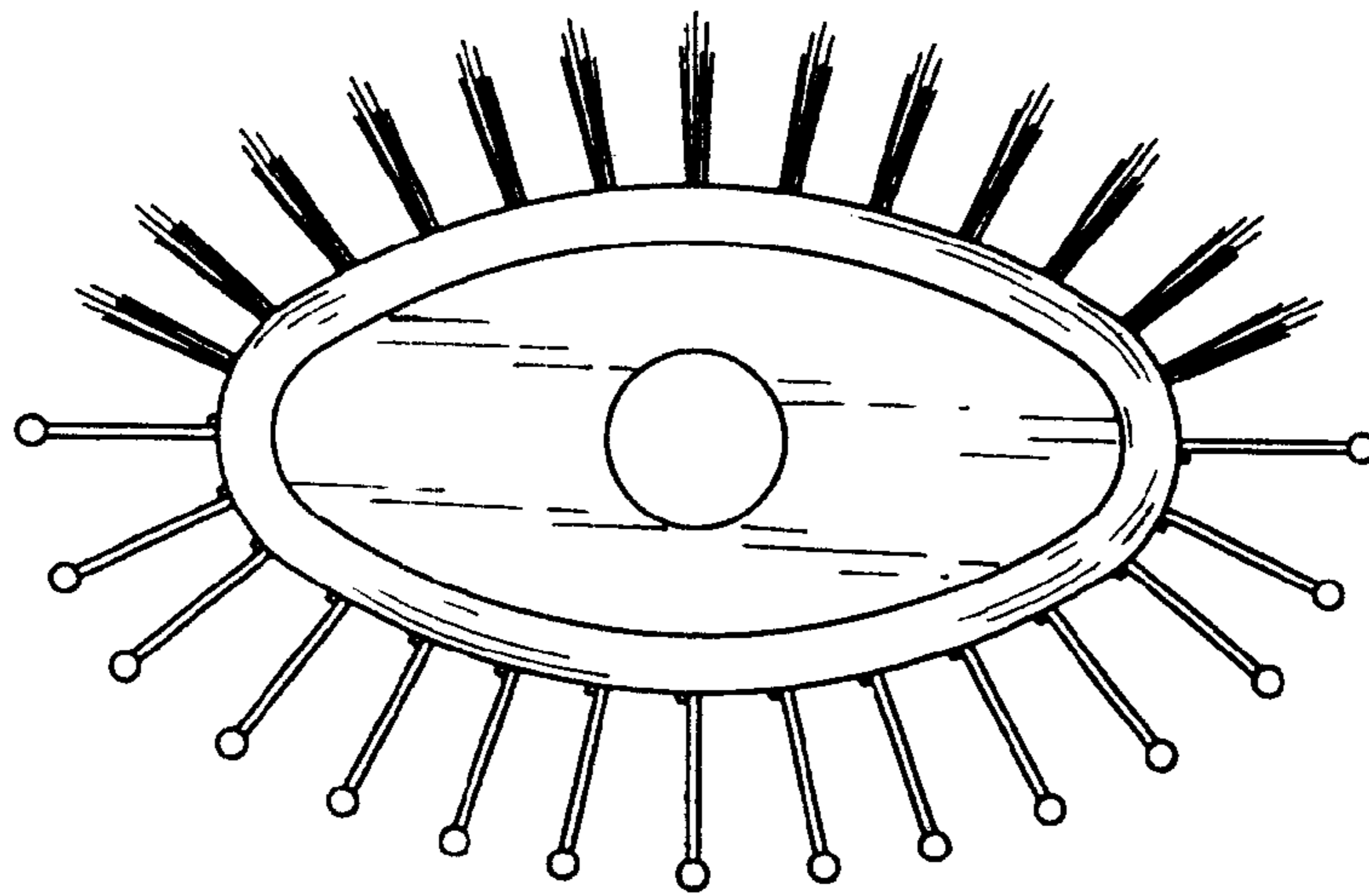

FIG. 5

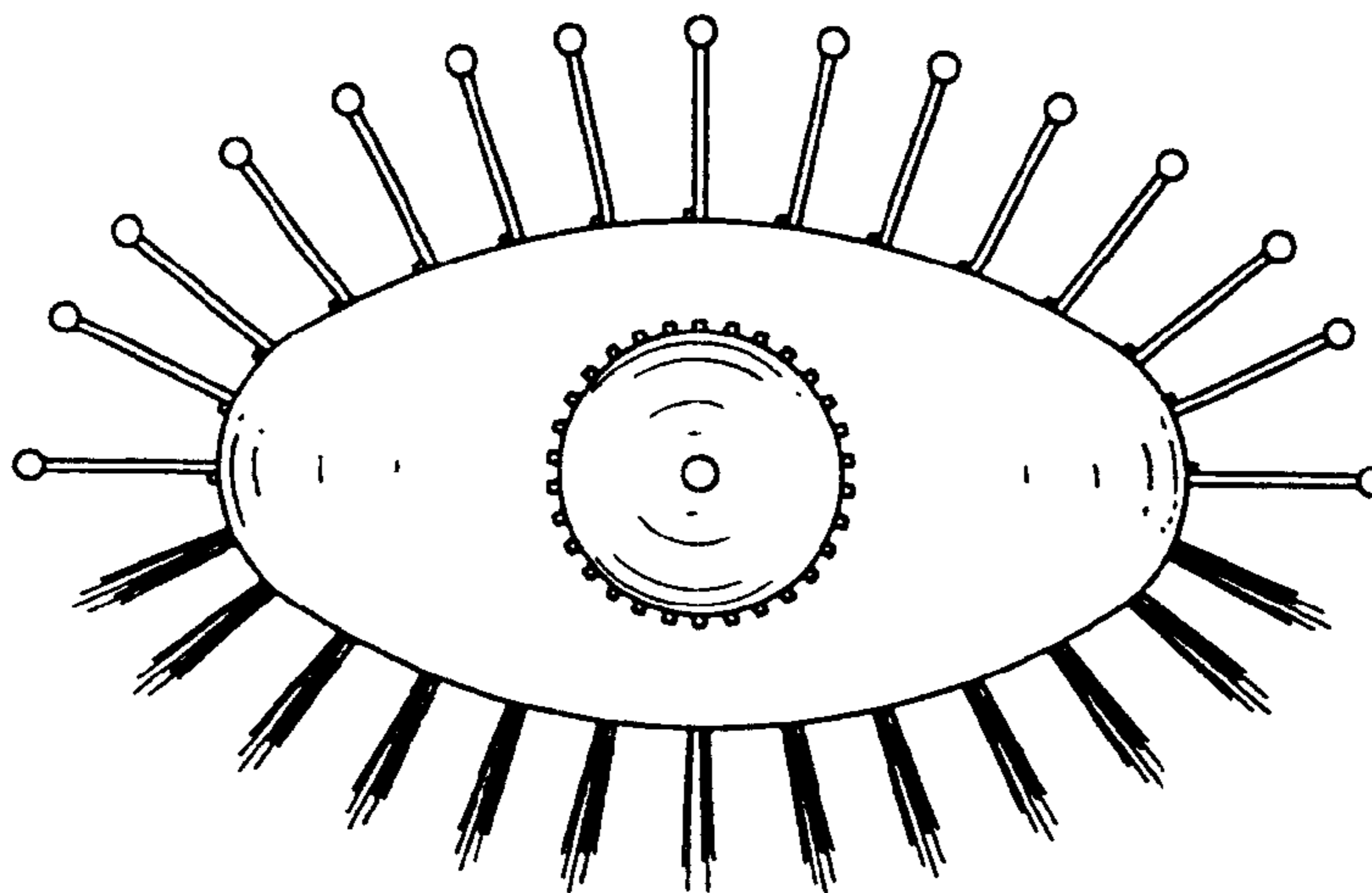

FIG. 6

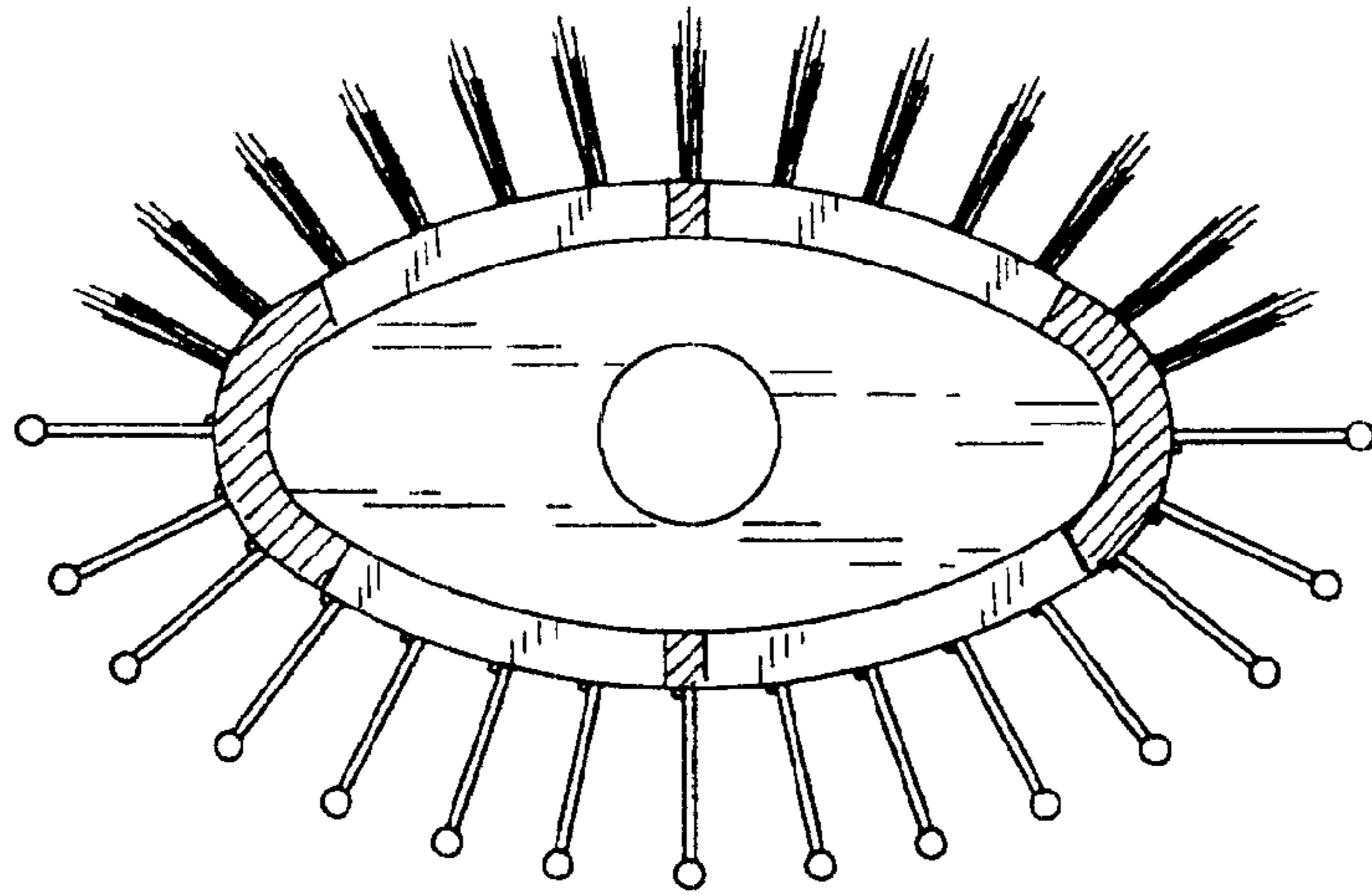

FIG. 7

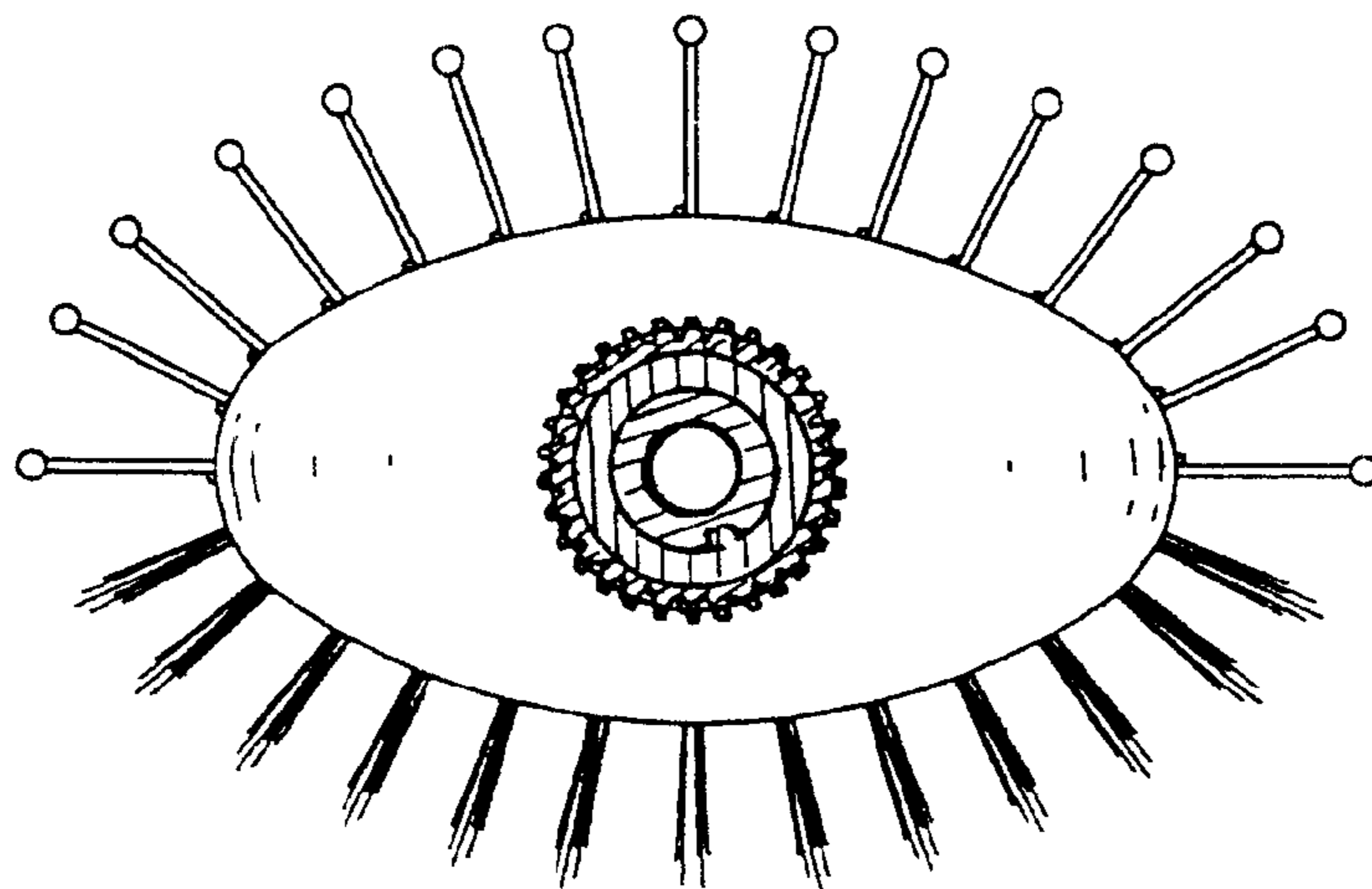

FIG. 8