



US00D471686S

(12) **United States Design Patent**
Zimmerman

(10) **Patent No.:** **US D471,686 S**

(45) **Date of Patent:** **** Mar. 11, 2003**

(54) **CONTAINER**

(75) Inventor: **Larry Gene Zimmerman**, Hollis, NH
(US)

(73) Assignee: **Sterilite Corporation**, Townsend, MA
(US)

(**) Term: **14 Years**

(21) Appl. No.: **29/159,737**

(22) Filed: **Apr. 26, 2002**

(51) **LOC (7) Cl.** **09-09**

(52) **U.S. Cl.** **D34/8**

(58) **Field of Search** D32/1, 5, 6, 7,
D32/8, 9, 10; 220/262, 263, 252, 908, 909,
910, 911

(56) **References Cited**

U.S. PATENT DOCUMENTS

D321,576 S * 11/1991 Hradisky D34/8

D324,749 S * 3/1992 Bray D34/7
D326,343 S * 5/1992 Hradisky D34/7
D418,957 S * 1/2000 Rashid D34/7
D421,840 S * 3/2000 Demore D34/8

* cited by examiner

Primary Examiner—Cynthia E. Ramirez

(74) *Attorney, Agent, or Firm*—Hale and Dorr LLP

(57) **CLAIM**

I claim the ornamental design for a container, as shown and described.

DESCRIPTION

FIG. 1 is a front end view of the container of this invention;
FIG. 2 is a side view thereof;
FIG. 3 is a rear end view thereof;
FIG. 4 is a top view thereof;
FIG. 5 is a bottom view thereof; and,
FIG. 6 is a perspective view thereof.

1 Claim, 2 Drawing Sheets

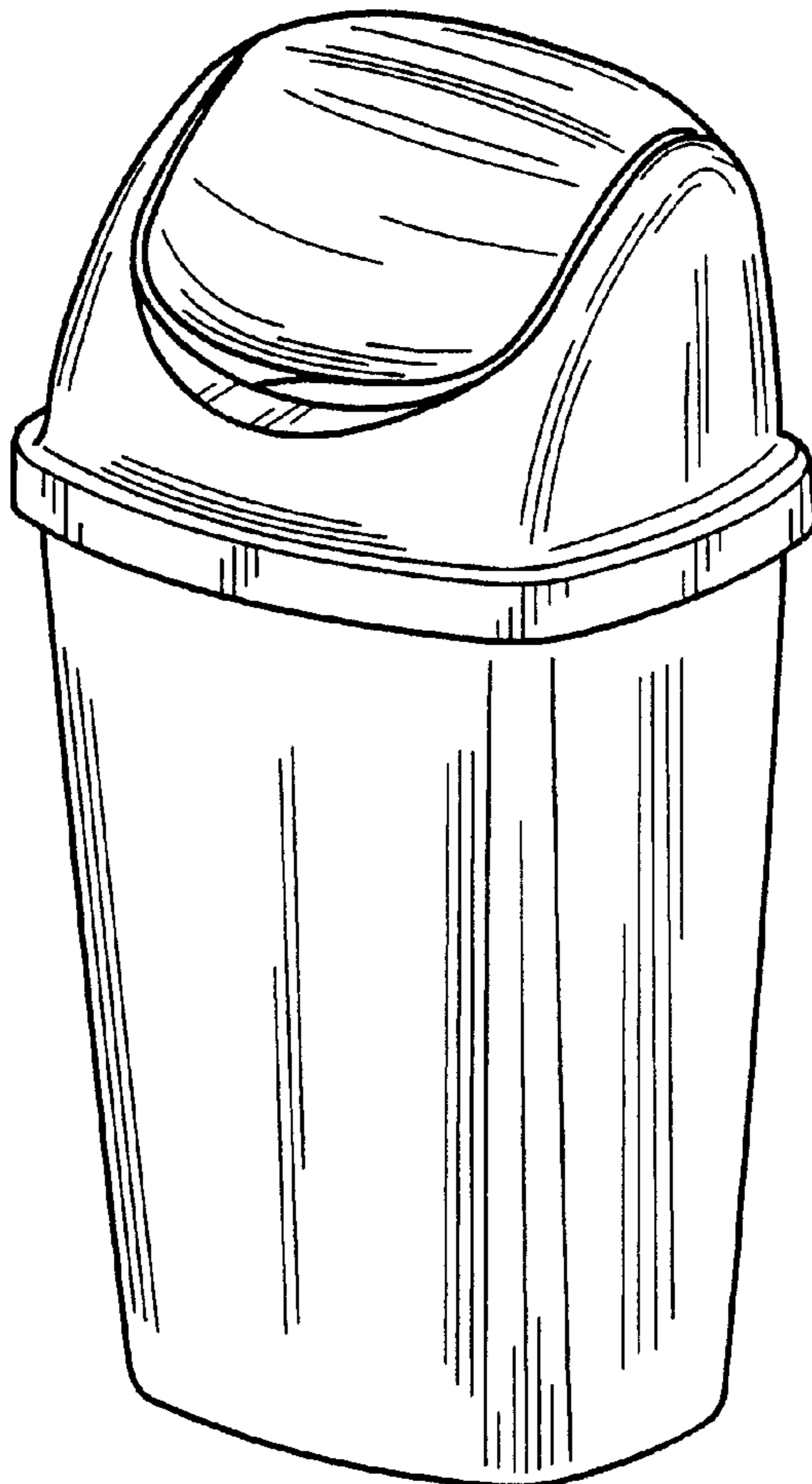

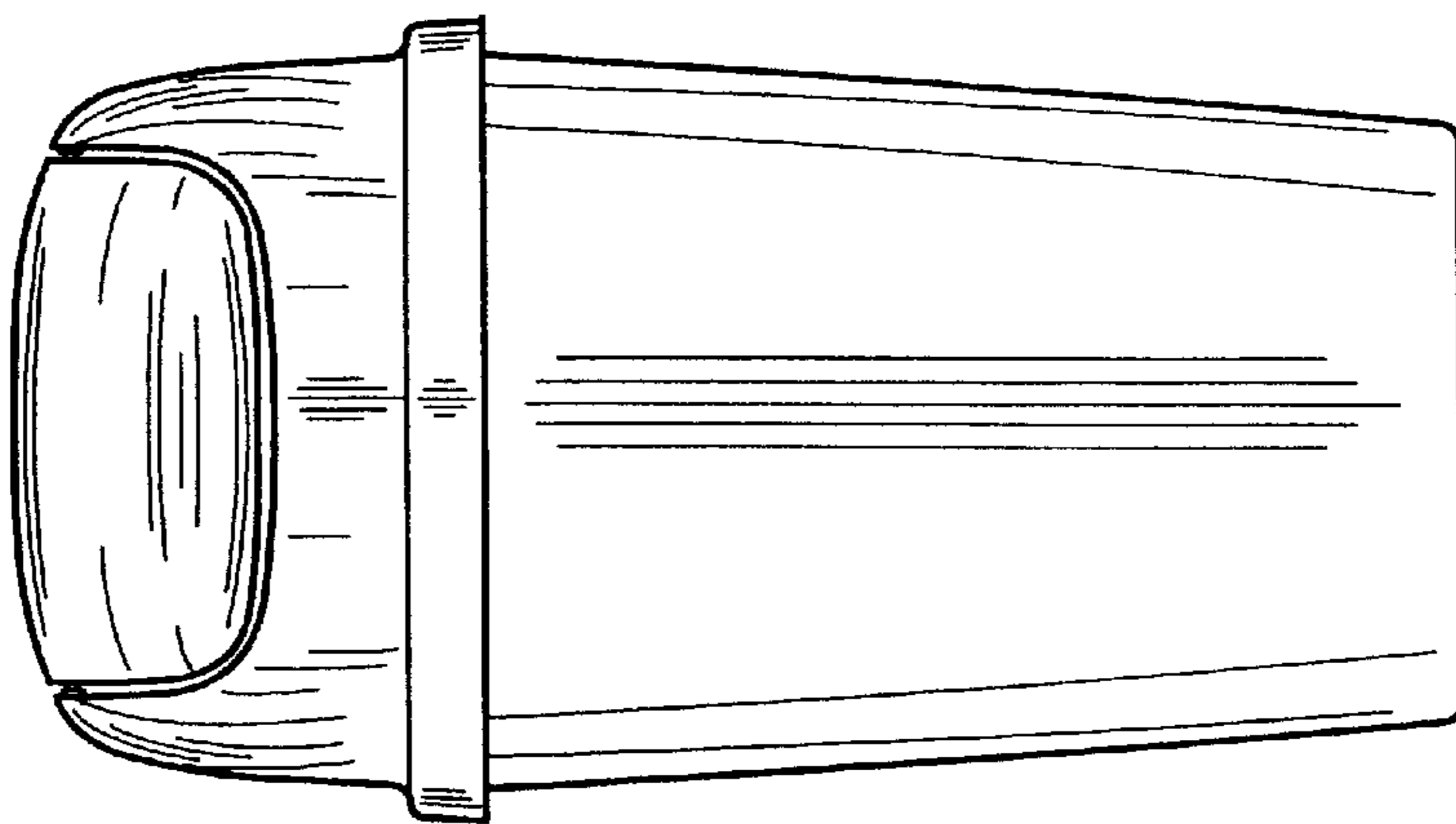

FIG. 1

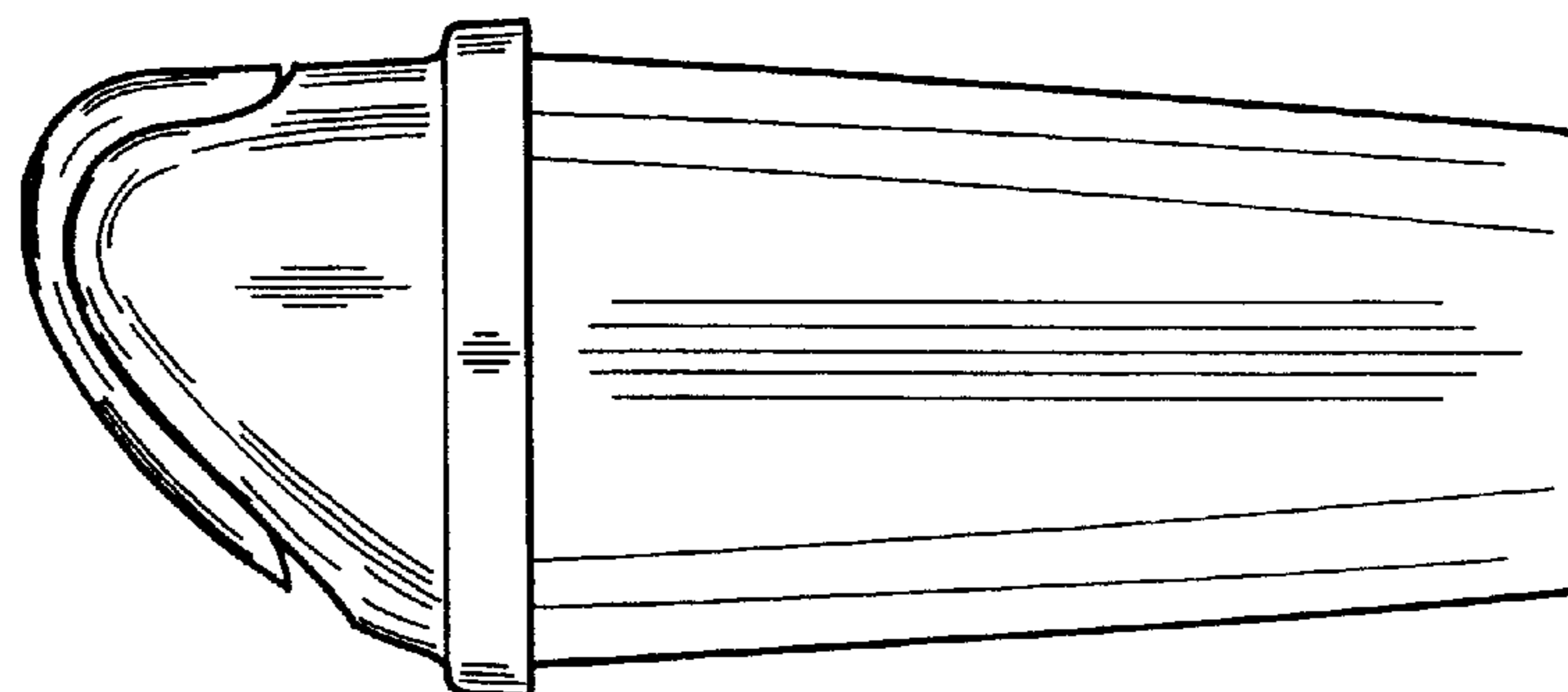

FIG. 2

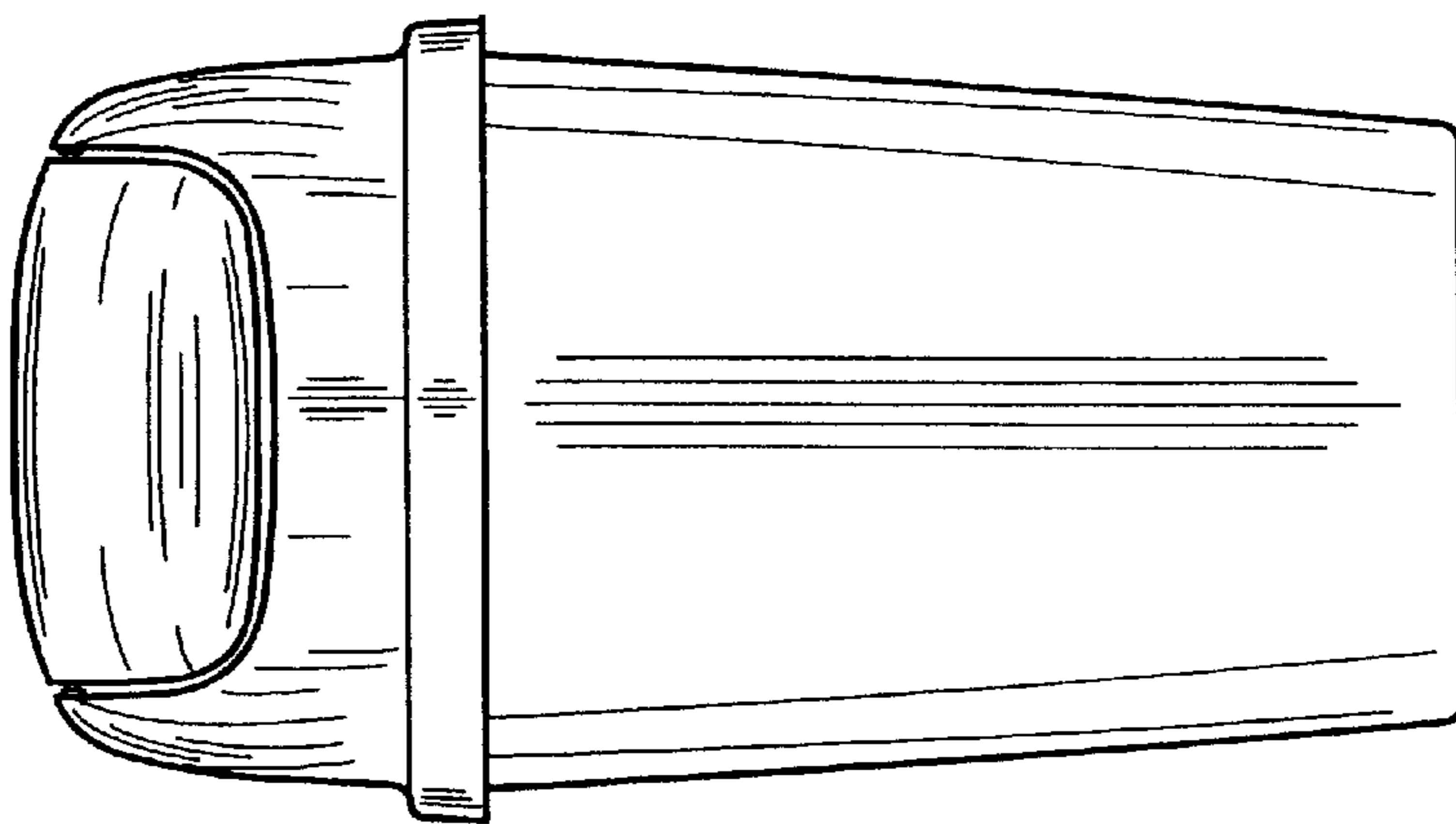

FIG. 3

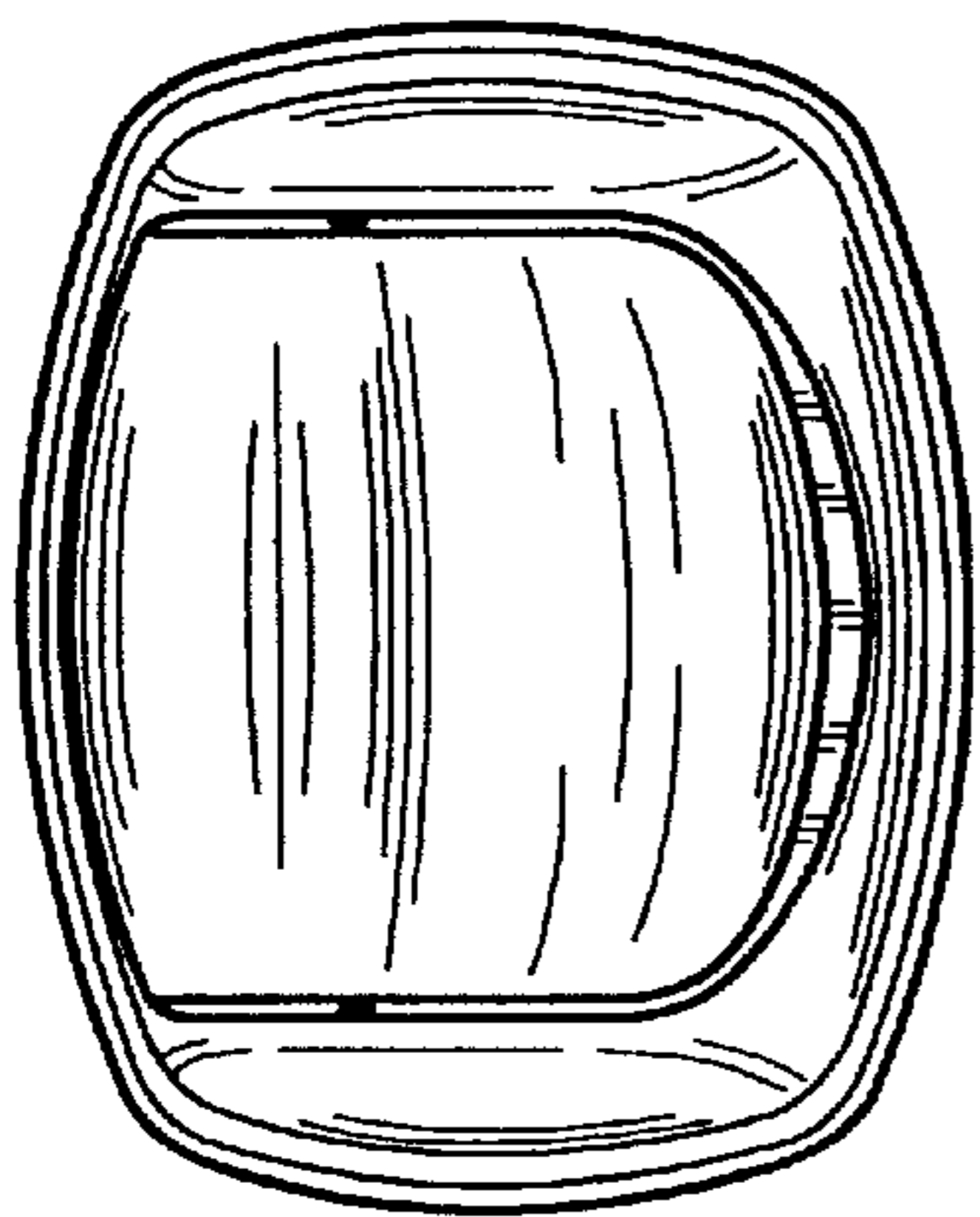

FIG. 4

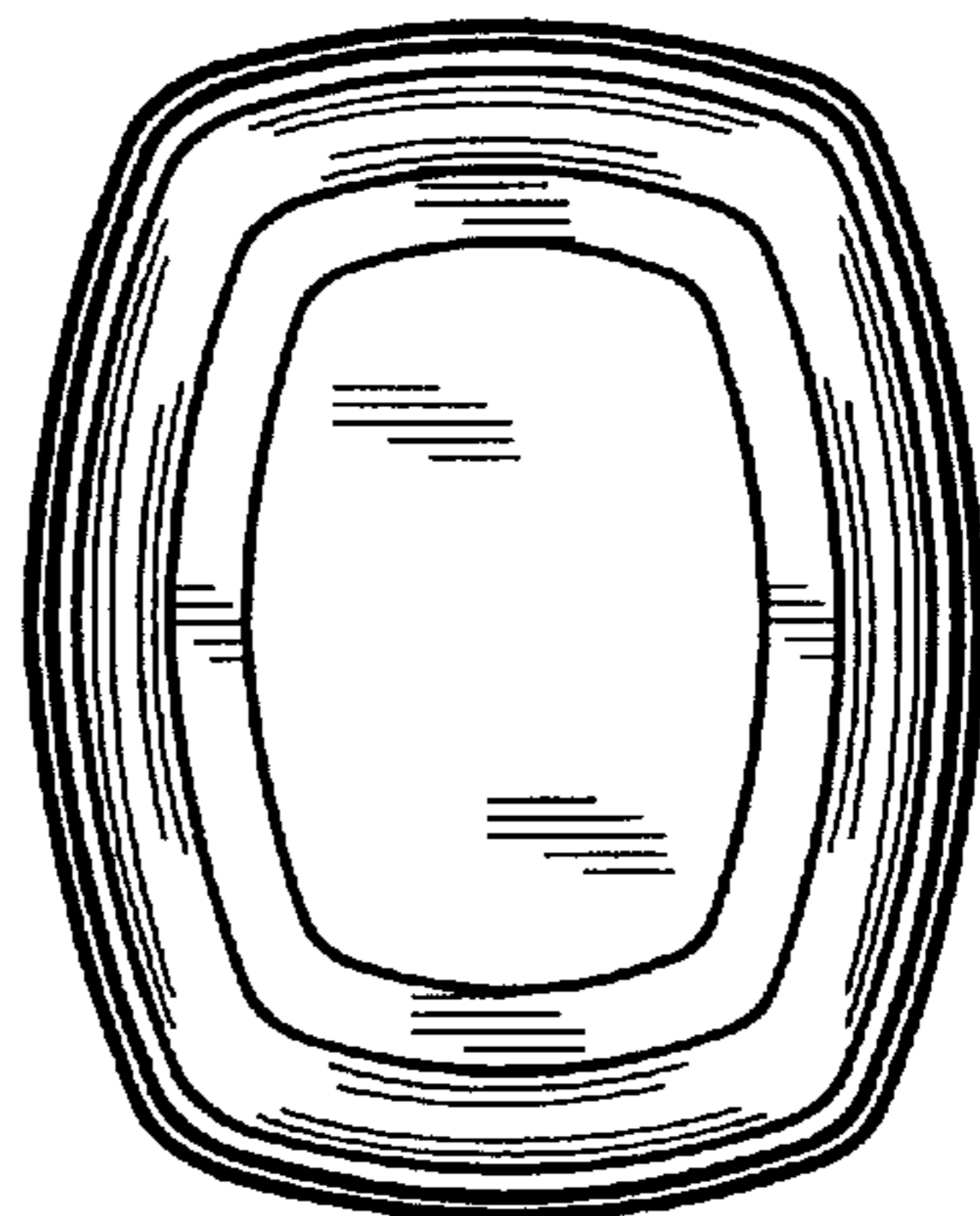

FIG. 5

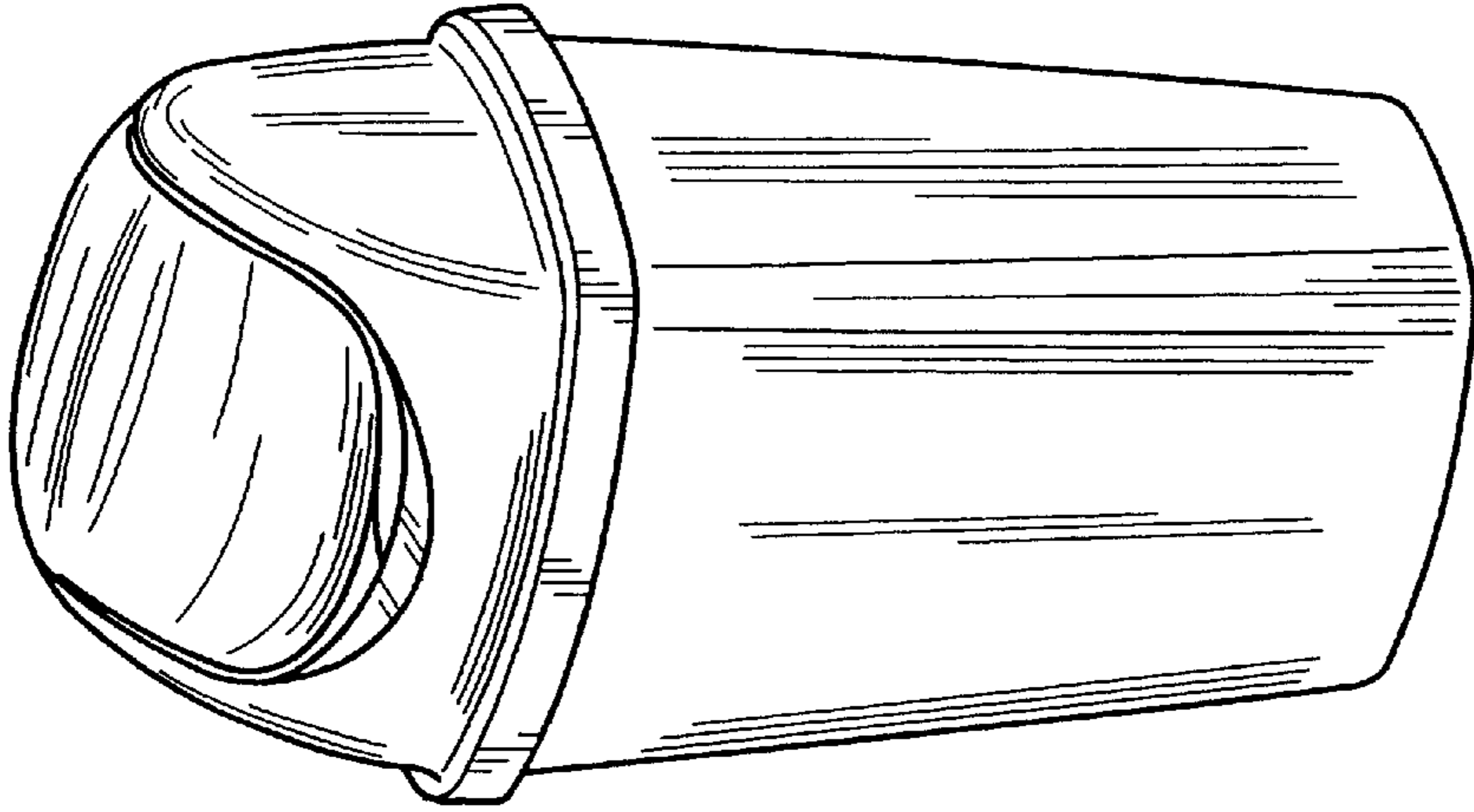

FIG. 6